

Distribution, speciation and fate of trace metals in the stratified Krka river estuary

Cindrić, Ana-Marija

Doctoral thesis / Disertacija

2015

Degree Grantor / Ustanova koja je dodijelila akademski / stručni stupanj: **University of Zagreb, Faculty of Science / Sveučilište u Zagrebu, Prirodoslovno-matematički fakultet**

Permanent link / Trajna poveznica: <https://um.nsk.hr/um:nbn:hr:217:527557>

Rights / Prava: [In copyright](#) / [Zaštićeno autorskim pravom.](#)

Download date / Datum preuzimanja: **2024-07-22**



Repository / Repozitorij:

[Repository of the Faculty of Science - University of Zagreb](#)





University of Zagreb

FACULTY OF SCIENCE

Ana-Marija Cindrić

**DISTRIBUTION, SPECIATION AND FATE
OF TRACE METALS IN THE STRATIFIED
KRKA RIVER ESTUARY**

DOCTORAL THESIS

Supervisors:

Dr. Dario Omanović

Dr. Cédric Garnier

Zagreb, 2015.



Sveučilište u Zagrebu

PRIRODOSLOVNO-MATEMATIČKI FAKULTET

Ana-Marija Cindrić

**RASPODJELA, SPECIJACIJA I SUDBINA
METALA U TRAGOVIMA U USLOJENOM
ESTUARIJU RIJEKE KRKE**

DOKTORSKI RAD

Mentori:

Dr.sc. Dario Omanović

Dr.sc. Cédric Garnier

Zagreb, 2015.

BASIC DOCUMENTATION CARD

University of Zagreb
Faculty of Science
Department of Geology

Doctoral Thesis

DISTRIBUTION, SPECIATION AND FATE OF TRACE METALS IN THE STRATIFIED KRKA RIVER ESTUARY

Ana-Marija Cindrić

Ruder Bošković Institute, Bijenička cesta 54, 10 000 Zagreb

The distribution, speciation, behaviour, and fate of selected trace metals (TM) (Zn, Cd, Pb, Cu, Ni, and Co) were studied in the water column of the highly stratified Krka River estuary, from 2009 to 2013, covering two contrasting seasons (summer/winter). In addition, the study involved measurements of dissolved/particulate organic carbon (DOC/POC) and major physico-chemical parameters (salinity, pH, dissolved oxygen, temperature). Water samples were taken from the three characteristic layers (brackish, the freshwater-seawater interface (FSI), and seawater). Stripping voltammetry (anodic, and adsorptive cathodic) was the primary analytical technique, while the diffusion gradient in thin films (DGT) technique was used as a complementary technique for speciation measurements.

The concentrations of all TM were lower in the Krka River than in the open Adriatic which allowed the identification of pathways and processes governing the horizontal and vertical redistribution of TM across the whole estuary, whether they were added into the system by human activity or by “*in-situ*” processes (e.g. scavenging). Non-conservative behaviour for most of the studied TM observed in the surface layer of the estuary was primarily caused by their input in the Šibenik Bay area. Detailed “mapping” of the bay showed that the harbour and nautical marina are the regions with the highest concentrations of TM. A significant increase of Cu and Zn in the entire estuary transect during the summer period appeared to be directly linked to intensive nautical activity i.e. caused by the release of TM from antifouling paints. The scavenging of metals into the deeper layers, along with the longer residence time of seawater, caused an upstream increase in TM concentrations in the seawater layer.

A very good agreement between the vertical profiles of DGT-labile, and dissolved TM concentrations suggests that the DGT technique can be successfully used to determine potentially bioavailable TM concentrations in estuarine conditions. The fraction of DGT-labile TM, which reflects their chemical speciation (primarily, their binding to natural organic ligands), ranged from > 90% for Cd, to < 20% for Cu, but also depends on the concentration ratios of metals and organic ligands. Voltammetric speciation of Cu showed the presence of two types of organic ligands that form strong (L_1 , $9.6 < \log K_1 < 11.9$) and weak (L_2 , $7.8 < \log K_2 < 9.9$) Cu complexes. The concentration of weak organic ligands (L_2) is correlated with the DOC concentration, and is higher in summer, most probably due to the increased biological activity. The concentration of free Cu ions (the most bioavailable form), at ambient conditions, is regulated primarily by the complexation with strong ligands (L_1). For most of the samples, the calculated free Cu slightly exceeds the toxic threshold of 10 pM. However, these values are the result of applied methodology of calculation, and does not necessarily reflect real ambient conditions.

Keywords: stratified estuary; Krka River estuary; trace metals; metal speciation; diffusive gradient in thin films, complexing capacity

Thesis contains: 214 pages, 95 figures, 24 tables and 307 references

Original in: English

Thesis deposited in: National and University Library of Zagreb

Supervisors: Dr. Dario Omanović, PhD, senior researcher
Dr. Cédric Garnier, PhD, assistant professor, HDR

Reviewers: Dr. Marta Plavšić, PhD, senior researcher
Dr. Mladen Juračić, PhD, full professor
Dr. Ivanka Pižeta, PhD, senior researcher

Thesis accepted: 03.06.2015.

TEMELJNA DOKUMENTACIJSKA KARTICA

Sveučilište u Zagrebu
Prirodoslovno-matematički fakultet
Geološki odsjek

Doktorska disertacija

RASPODJELA, SPECIJACIJA I SUDBINA METALA U TRAGOVIMA U USLOJENOM ESTUARIJU RIJEKE KRKE

Ana-Marija Cindrić

Institut Ruđer Bošković, Bijenička cesta 54, 10 000 Zagreb

Raspodjela i specijacija odabranih metala u tragovima (TM) (Zn, Cd, Pb, Cu, Ni i Co), te njihovo ponašanje i sudbina istraživani su u vodenom stupcu vertikalno uslojenog estuarija rijeke Krke tijekom dva kontrastna godišnja doba (ljet/zima) u periodu od 2009 do 2013. Istraživanja su obuhvaćala i mjerenja otopljenog/partikulatnog organskog ugljika (DOC/POC), te osnovnih fizičko-kemijskih pokazatelja (salinitet, pH, otopljeni kisik, temperatura), a uzorkovanja su provedena u tri karakteristična sloja (boćati sloj, haloklina i morski sloj). Voltametrijom s akumulacijom (anodna i adsorptivna katodna) bila je primarna analitička tehnika, dok je za specijaciju korištena i komplementarna tehnika pasivnog uzorkovanja temeljena na principu difuzijskog gradijenta u tankom filmu (DGT).

Koncentracije TM niže su u rijeci Krki nego u vodi otvorenog dijela Jadrana, što je omogućilo identifikaciju puteva i procesa koji reguliraju horizontalnu i vertikalnu preraspodjelu TM u cijelom estuariju, neovisno da li su oni u sustav uneseni ljudskom aktivnošću ili „*in-situ*“ procesima (npr. tonjenje „*scavenging*“). Nekonzervativno ponašanje u površinskom sloju estuarija uočeno za većinu TM uzrokovano je primarno unosom metala u području Šibenskog zaljeva. Detaljno „mapiranje“ zaljeva pokazalo je da su luka i nautička marina područja s najvišom koncentracijom TM. Pokazalo se da je značajan porast Cu i Zn u cijelom estuariju tijekom ljetnih mjeseci u izravnoj vezi s pojačanom nautičkom aktivnošću, odnosno vezani su za otpuštanje metala iz protuobraštajnih boja s plovila. Vertikalni transport TM u dublje slojeve („*scavenging*“), te dulje vrijeme zadržavanja morske vode uzrokovali su uzvodni porast koncentracije TM u morskom sloju.

Vrlo dobro slaganje vertikalnih profila DGT-labilnih i otopljenih koncentracija TM ukazuju da se DGT tehnika može uspješno koristiti za određivanje potencijalno biorasploživih koncentracija TM u estuarijskim uvjetima. Udio DGT-labilnih TM odraz je njihove kemijske specijacije (primarno vezanja s prirodnim organskim ligandima), te varira od > 90% za Cd, do < 20% za Cu, ali ovisan je također i o omjeru koncentracije metala i organskih liganada. Voltametrijska specijacija Cu pokazala je prisutnost dva tipa organskih liganada koji stvaraju jake (L_1 , $9.6 < \log K_1 < 11.9$) odnosno slabe (L_2 , $7.8 < \log K_2 < 9.9$) Cu komplekse. Koncentracija slabijih organskih liganada (L_2) u korelaciji je s koncentracijom DOC-a, te je veća ljeti najvjerojatnije zbog povećane biološke aktivnosti. Koncentracija slobodnih iona Cu (vrsta koja je najviše biorasploživa) pri okolišnim uvjetima regulirana je u većoj mjeri kompleksiranjem s jakim ligandima (L_1). Za većinu uzoraka izračunate vrijednosti slobodnog Cu blago prelaze graničnu toksičnu vrijednost od 10 pM. Međutim, te vrijednosti su rezultat upotrijebljenog načina izračuna i ne odražavaju nužno stvarno stanje.

Ključne riječi: stratificirani estuarij; estuarij rijeke Krke, metali u tragovima; specijacija metala; difuzijski gradijent u tankom filmu; kapacitet kompleksiranja

Rad sadrži: 214 stranica, 95 slika, 24 tablice i 307 literaturnih navoda

Jezik izvornika: Engleski

Rad je pohranjen u: Nacionalnoj i sveučilišnoj knjižnici u Zagrebu

Mentori: Dr.sc. Dario Omanović, znanstveni savjetnik
Dr.sc. Cédric Garnier, HDR

Ocjenjivači: Dr.sc. Marta Plavšić, znanstvena savjetnica
Prof. dr.sc. Mladen Juračić, redoviti profesor
Dr.sc. Ivanka Pižeta, znanstvena savjetnica

Rad prihvaćen: 03.06.2015.

Thank you notes :)

Many thanks to my supervisors Dr. Dario Omanović and Dr. Cédric Garnier on guiding me to gain new knowledge, a lot of patience, understanding, help and support. I would like to thank you for a number of useful tips and discussions. There was lot of laughs, sweat and late-night work, but we made it!

Thank you Dr. Ivanka Pižeta for the interest, support, help and suggestions in past six years, especially during thesis writing.

Many thanks to Dr. Neven Cukrov for ideas, advices, help with boats and scuba-diving even in extreme conditions.

Thanks to my dear Dr. Véronique Lenoble for listening and encouragement, for a lot of laugh and crazy ideas!!!

I would like to thank all the employees of the Laboratory for Physical Chemistry of Traces on unconditional assistance at every opportunity, the kindness and courtesy and friendly atmosphere. My thanks also go to other members of the Institute Ruđer Bošković who in any way contributed to making this work.

Great thanks to my IRB-friends, especially Marijana, Nesreta, Željka, Ivana and Tea, and all the others, for nice times, great ideas and interesting scientific conversations that we had in the last six years!!

Thank you my French friends (Benjamin, Hanane and Huy) for your help, a lot of talks, and nice time that we spend together in Croatia and in France!

I would like to thank all my dear friends (Lana, Ivana, Lina, Margareta, Hrvoje, Marijo, Tom, Kruno, Vedran, Mislav and many others) for their patience and great support.

Special thanks to my husband Domagoj for his support, patience, listening, wiping my tears when it was hard, and waiting for me when I was far away from home ☺

Biggest thanks to my mother Vesna, sister Petra and grandmother Ljubica for their support to keep going when it was hard, and for nice words of encouragement, advices and patience!!

Love you very much!!!

Abbreviations and Symbols

Acronyms

α_{Cu}	Inorganic side reaction coefficient for Cu
ASV	Anodic Stripping Voltammetry
CC	Pearson's Correlation Coefficient
CLE-AdCSV	Competing Ligand Exchange-Adsorptive Cathodic Stripping Voltammetry
CE	Counter Electrode
CI	Confidence Interval
CuCC	Copper Complexing Capacity
D	Diffusion coefficient of metal specie
DBL	Diffusive Boundary Layer
DGT	Diffusive Gradients in Thin films
DO	Dissolved Oxygen
DOC	Dissolved Organic Carbon
DOM	Dissolved Organic Matter
DPV	Differential Pulse Anodic Stripping Voltammetry
EDTA	EthyleneDiamineTetraacetic Acid
FEP	Fluorinated Ethylene Propylene
FSI	Freshwater-Seawater Interface layer
FW	Freshwater/Brackish Water layer
GFF	Glass Fiber Filter (0.7 μm)
HDPE	High Density PolyEthylene
HMDE	Hanging Mercury Drop Electrode
HS	Humic Substances
HR ICP-MS	High Resolution Inductively Coupled Plasma Mass Spectroscopy
K_i or K_i'	Conditional stability constant of metal complex with i -th ligand
K_D	Distribution coefficient
L_i	i -th Ligand
LOD/LOQ	Limit of Detection/Quantification
M	Metal
MCC	Metal Complexing Capacity
ML	Metal Ligand Complex
MQ	Milli-Q Water
NOM	Natural Organic Matter
NTA	NitriloTriacetic Acid
OP	Open Pore DGT
PFA	PerFluoroAlkoxy
PP	PseudoPolarography
<i>ppt</i>	parts per trillion (ng kg^{-1})
POC	Particulate Organic Carbon
RE	Reference Electrode
RP	Restricted Pore DGT
SPM	Suspended Particulate Matter
SW	Seawater layer
TM	Trace Metals
TWA	Time Weighted Average
UV	Ultra Violet
WE	Working Electrode

TABLE OF CONTENTS

Basic Documentation Card	V
Temeljna dokumentacijska kartica	VII
Thank you notes ☺	IX
Abbreviations and Symbols	XI
Prošireni sažetak	1
1. Introduction	17
2. Literature overview	21
2.1. Metals in aquatic environment	21
2.1.1. Definition of terminology: heavy metals, toxic metals or trace metals	21
2.1.2. Trace metals in natural waters	22
2.1.3. Trace metals in seawater	24
2.2. Organic matter in natural waters	25
2.3. Coastal environments – Estuaries	27
2.3.1. Main types of estuaries	28
2.3.2. Processes in estuaries	30
2.3.2.1. Sedimentation processes	31
2.3.2.2. Chemical processes	31
2.3.3. Trace metals in estuaries	35
2.4. Speciation of trace metals in natural waters	38
2.4.1. Complexes of trace metals in natural waters	40
2.4.2. Trace metals speciation in the estuary	41
2.4.3. Bioavailability and effect of competition	42
2.5. Determination of trace metals concentration and speciation	43
2.5.1. Voltammetric techniques for trace metal speciation determination	44
2.5.1.1. <i>Anodic stripping voltammetry (ASV)</i>	45
2.5.1.2. <i>Adsorptive Cathodic stripping voltammetry (AdCSV)</i>	46
2.5.2. Diffusive gradient in thin films (DGT) technique	47
2.5.2.1. <i>Factors affecting DGT performance</i>	49
2.5.2.2. <i>Diffusion coefficients of trace metals in hydrogel</i>	51
2.5.2.3. <i>Determination of trace metal concentration by DGT</i>	54
2.5.2.4. <i>Speciation of trace metals by DGT</i>	54
2.5.2.5. <i>Practical problems associated to DGT measurements</i>	56
2.5.3. Metal complexing capacity (MCC)	58
2.5.3.1. <i>Calculation of complexation parameters – a theory</i>	59
2.5.3.2. <i>Design of the experiment</i>	62

3. Experimental part and methodology	65
3.1. Study site	65
3.2. Chemicals	67
3.3. Instrumentation and equipment	68
3.4. Cleaning (washing) procedure	68
3.5. Sampling protocols	69
3.5.1. Sampling along the estuary transect	70
3.5.2. “Cross-section” (transversal) transect sampling	71
3.5.3. Sampling in the Šibenik Bay	72
3.5.4. Sampling and DGT deployment at Martinska (“clean”) and nautical marina (“polluted”) sites	74
3.6. Sample preparation	77
3.6.1. Unfiltered samples	77
3.6.2. Filtration under nitrogen pressure	77
3.6.3. Filtration under vacuum	78
3.6.4. On-board filtration	79
3.6.5. Sample preparation for electrochemical measurement	79
3.6.6. DGT resin gel retrieval	79
3.7. Analytical measurement	81
3.7.1. Multi-elemental analysis by ICP-MS	81
3.7.2. Voltammetric analysis of trace metals	81
3.7.3. Voltammetric determination of Cu complexing capacity (CuCC)	84
3.7.4. Carbon analysis	85
3.7.5. Determination of effective diffusion coefficients for OP and RP DGT gels	85
4. Results	89
<i>Chapter I: “Evidencing the natural and anthropogenic processes controlling trace metals dynamic in the Krka River estuary”</i>	89
4.1. Hydrological conditions of the Krka River	89
4.2. Estuarine major physic-chemical parameters	90
4.2.1. Suspended particulate matter (SPM)	90
4.2.2. Salinity, temperature and dissolved oxygen	92
4.2.3. Dissolved inorganic carbon (DIC) and pH	94
4.2.4. Dissolved and particulate organic carbon (DOC/POC)	96
4.3. Distribution of trace metals	101
4.3.1. End members	101
4.3.2. Distribution of trace metals within the Šibenik bay	102
4.3.3. Distribution of trace metals along the salinity gradient	107

<i>Chapter II: “In-situ speciation of trace metals in a vertical salinity gradient of the Krka River estuary using Diffusive Gradient in Thin Films (DGT) technique”</i>	109
4.4. Hydrographic conditions	109
4.5. Major physic-chemical parameters during deployment period	110
4.5.1. Salinity	110
4.5.2. Temperature	112
4.5.3. Dissolved oxygen	114
4.5.4. Dissolved organic carbon (DOC)	114
4.6. Determination of diffusion coefficients of metals	115
4.7. Vertical distribution of dissolved and DGT-labile concentrations of trace metals at Martinska (“clean”) site	119
4.7.1. Zinc (Zn)	120
4.7.2. Cadmium (Cd)	121
4.7.3. Lead (Pb)	123
4.7.4. Copper (Cu)	124
4.7.5. Nickel (Ni)	126
4.7.6. Cobalt (Co)	127
4.8. Vertical distribution of dissolved and DGT-labile concentration of trace metals at nautical marina (“polluted”) site	129
 <i>Chapter III: “Assessing Cu speciation in the Krka River estuary under different environmental and anthropogenic conditions – an electrochemical complexometric titration study”</i>	133
4.9. Setup of critical experimental parameters and data treatment methodology for determination of CuCC	133
4.9.1. Selection of accumulation (deposition) potential	133
4.9.2. Equilibration time and titration type	135
4.9.3. Treatment of voltammograms – signal intensity feature determination	138
4.9.4. Treatment of complexometric titration curves – fitting to a model	139
4.9.5. Complexometric titration curves	141
5. Discussion	145
 <i>Chapter I: “Evidencing the natural and anthropogenic processes controlling trace metals dynamic in the Krka River estuary”</i>	145
5.1. Conceptual hydrodynamic model of element transport	145
5.2. Behavior of trace metals along the salinity gradient	146
5.2.1. Zinc (Zn)	146
5.2.2. Cadmium (Cd)	149

5.2.3. Lead (Pb)	151
5.2.4. Copper (Cu)	154
5.2.5. Nickel (Ni)	157
5.2.6. Cobalt (Co)	158
5.3. Partitioning of trace metals	160
5.3.1. Distribution of K_D in the surface (brackish) layer	163
5.3.2. Distribution of K_D in the bottom (seawater) layer	166
<i>CHAPTERS II and III: Speciation of trace metals in the Krka River estuary</i>	<i>167</i>
5.4. Data quality in analytical/speciation measurements – a critical overview	167
5.4.1. Taking into consideration the level of a blank	168
5.4.2. Signal intensity (feature) determination in complexometric titrations	169
5.5. Dynamic DGT speciation analysis of trace metals	171
5.5.1. Distribution of DGT-labile metals	172
5.5.2. Correlation between DGT-labile and predicted dynamic metal concentration	178
5.6. Voltammetric speciation of Cu – determination of CuCC	181
5.7. Environmental aspects – potential toxicity effects	188
6. Conclusions	191
7. References	193
8. Curriculum Vitae and list of publications	211

Prošireni sažetak

Prošireni sažetak

1. Uvod

1.1. Metali u prirodnim vodama

Metali su prirodni konstituenti vodenog okoliša. S obzirom da su nerazgradivi, jednom uneseni u sustav, gotovo trajno postaju njegovim dijelom. Prirodne razine metala u vodama („background“) ovise o području u kojem se nalaze, odnosno sastavu stijena i tla, te se stoga može govoriti o specifičnosti vodnih područja s obzirom razinu pojedinih metala (Sl. 1). U vodenoj sredini, koncentracija metala rezultat je niza procesa koji reguliraju njihov biogeokemijski ciklus. Raspon prirodnih koncentracija metala u vodama kreće se od nekoliko mikrograma do manje od nanograma po litri. Za metale koji su prisutni u vrlo niskim koncentracijama (obično manje od 10^{-8} mol L⁻¹), u literaturi se koriste razni sinonimi kao što su *tragovi metala i mikronutrijenti/mikroelementi*, a određeni metali često se nazivaju i *teški* odnosno *eko-toksični metali*. Istraživanja su uglavnom usmjerena prema metalima i metaloidima koji imaju poznatu biološku funkciju poput Fe, Cu, Zn, Co, Se, ili su poput Hg, Cd, As, Cr toksični. Primjerice, esencijalni metali (Zn, Cu) važan su faktor u fiziološkom funkcioniranju živih organizama jer reguliraju mnoge biokemijske procese, no ako su prisutni u povećanim koncentracijama mogu imati toksični utjecaj na živa bića, a time posredno i na čovjeka. Prirodne razine metala u tragovima mogu se povisiti uslijed njihovog antropogenog unosa kao rezultat različitih aktivnosti poput turizma, prometa, poljoprivrede, industrije, ispuštanje otpadnih voda, izgaranje fosilnih goriva (Sl. 1).

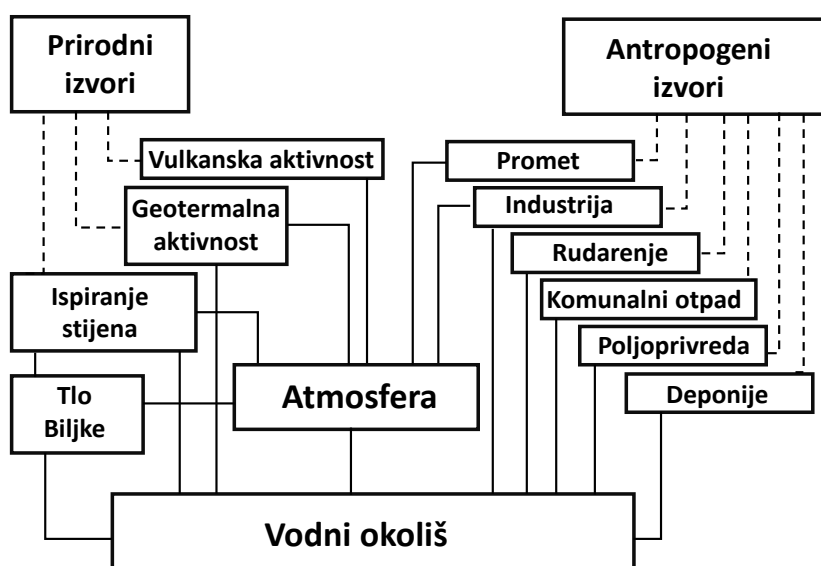

Slika 1. Prirodni i antropogeni izvori metala i njihov unos u vodeni sustav.

1.2. Estuariji

Općenito, estuariji su obalna polu-zatvorena područja gdje se riječna voda miješa s morskom. Estuariji su nastali tijekom podizanja razine mora i poplava u riječnim dolinama. Gradijent saliniteta je ključna varijabla koja čini estuarije drugačijima od morskih i jezerskih sustava i važan je za cirkulaciju u estuarijima. Uz uvijek prisutni horizontalni, gradijent saliniteta može biti i vertikalni. Uz morfologiju područja, na vertikalnu i horizontalnu raspodjelu saliniteta značajno utječu još i plima, vjetar, valovi i protok rijeke. Prema načinu miješanja estuariji se dijele na *estuarije slanog klina* (miješanje na granici riječne i morske vode koje uzrokuje prodiranje morske vode a zbog minimalnog miješanja nastaje klin, koji je najdeblji na dijelu prema otvorenom moru, a smanjuje se prema kopnu); *visoko uslojene* (stratificirane) *estuarije* (u morima, s malim rasponom između plime i oseke, manje rijeke stvaraju visoko stratificirane estuarije, u kojima je vodeni stupac podijeljen na gornji boćati i donji morski sloj, koje razdvaja oštra haloklina); *zaštićene estuarije s pragom* (djelomično su zatvoreni prema oceanu plitkim površinskim pragom, cirkulacija nije u cijelosti razvijena - povratni tok slane morske vode blokiran je u dubini); *dobro miješane estuarije* (dominante plimne struje u odnosu na riječni tok, voda je dobro izmiješana, bez veće promjene saliniteta u vertikalnom stupcu).

1.3. Metali u tragovima u estuarijima

U prirodnom ekosustavu je od izuzetne važnosti razumijevanje ponašanja, sudbine i utjecaja metala u tragovima. Potrebno je imati na umu različite faktore koji kontroliraju biogeokemiju metala, posebno u estuarijima, gdje postoji velika razlika u sastavu vode, a uključuje fizikalne i kemijske promjene raspodjele i specijacije metala u tragovima (Muller et al., 1996). U estuarijima fizikalni parametri i biološka aktivnost utječu na razdjeljivanje i specijaciju metala u tragovima kroz procese kompleksacije, sorpcije, flokulacije, precipitacije, otapanja i otpuštanja. U estuarijskim uvjetima u kojima postoji gradijent saliniteta postoji i gradijent koncentracije kojim se opisuje kompleksno ponašanje metala u tragovima. Ovisno o svojstvima metala, kao i o fizikalno kemijskim, hidrodinamičkim i okolišnim (npr. zagađenje) uvjetima, ponašanje može biti i konzervativno i nekonzervativno (Sl. 2). Do nekonzervativnog ponašanja metala u tragovima u zoni miješanja, u estuarijima, dolazi zbog varijacija u ionskoj jakosti, adsorpciji ili biološkim utjecajem.

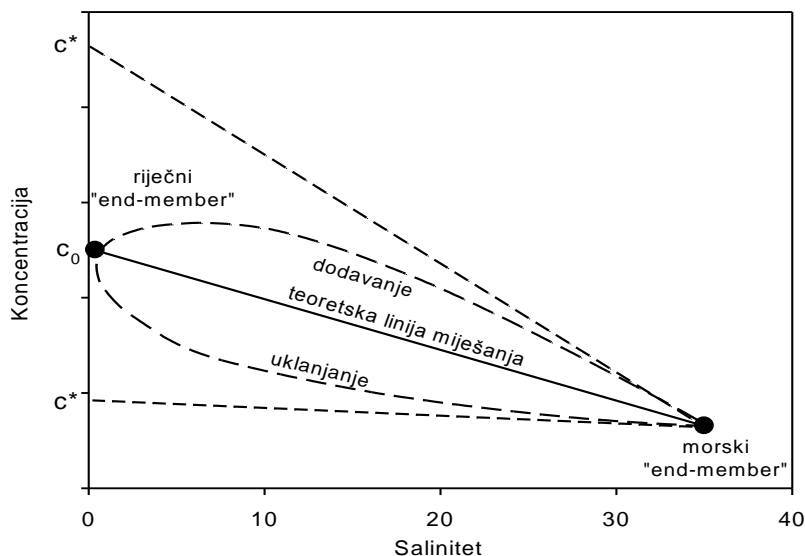

Slika 2. Ilustracija ponašanja metala u gradijentu saliniteta (Wen et al., 1999).

1.4. Specijacija metala u tragovima

Specijacija je kvalitativno i kvantitativno određivanje raspodjele fizičko-kemijskih vrsta metala u tragovima u prirodnim vodama. Temeljni razlozi za istraživanje i utvrđivanje specijacije tragova metala u vodenim sustavima je razumijevanje mehanizma pod kojim se odvija proces njihovog biološkog i geokemijskog kruženja. O raspodjeli kemijskih oblika, odnosno specijaciji (Tessier and Turner, 1996) u prirodnim vodama ovise reaktivnost, transport, bioraspoloživost i/ili toksičnost metala prema mikroorganizmima. Općenito, specijacija tragova metala može se promatrati obzirom na upotrijebljene metode određivanja raspodjele pojedinih fizičko-kemijskih oblika (*operaciona specijacija*) i obzirom na određivanje raspodjele pojedinih kemijskih oblika i vrsta (*kemijska specijacija*).

U prirodnim vodama prisutne su različite vrste aktivnih mjesta koje vežu metale u tragovima. Dijele se na anorganske i organske ligande, površine čestica i površine organizama (različite biološke membrane). Prema tome, metali u tragovima u prirodnim vodama raspodjeljuju se između otopljenih vrsta i vrsta vezanih na čestice. Ova operativna definicija podrazumijeva da otopljena frakcija uključuje oblike metala koji prolaze kroz filter s definiranom veličinom pora (0.45 ili 0.2 μm). Čestice koje prođu kroz filter mogu biti anorganskog i organskog podrijetla, metali u tragovima, a koloidne čestice (pr. $\text{Fe}(\text{OH})_3$) mogu biti u formi čestica dovoljno malih da prođu kroz membranu filtra. Čestice mogu biti organske (živi organizmi i njihovi metabolički produkti) i anorganske (razni minerali koji potječu od stijena, silicij i kalcij koji potječu od uginulih organizama i sl.).

1.5. Određivanje kapaciteta kompleksiranja metala

U prirodnim vodama vezanje metala s anorganskim ligandima je poznato i računski predvidivo, no razumijevanje interakcija između metala i prirodne organske tvari (kopnenog - u priobalnim područjima ili autohtonog podrijetla - nastala u vodenom stupcu) (Bruland et al., 2004) i dalje je nedovoljno poznato, te stoga predstavlja veliki znanstveni izazov. Zbog niskih koncentracija u kojima su prisutni metali u tragovima (do razine pM) i zbog eksperimentalnih ograničenja vezanih uz odvajanje, ekstrakciju i mjerenje različitih kompleksa metala pomoću drugih analitičkih tehnika, uobičajeno se za karakterizaciju interakcija metala i organskih liganada koristi neizravan pristup, temeljen na titracijskoj metodologiji (Bruland et al., 2000; Louis et al., 2009; Omanović et al., 1996; Plavšić et al., 1982, 2009). Zbog dobre selektivnosti i visoke osjetljivosti najčešće se koriste elektrokemijske tehnike: anodna voltametrijna otapanja (Garnier et al., 2004) i adsorptivna katodna voltametrijna otapanja s kompetitivnom izmjenom iona (van den Berg, 1985). Elektrokemijskim titracijama određuju se parametri kompleksiranja, koncentracija liganada (L_i) i uvjetna konstanta stabilnosti (K'_i) koje se koriste u izračunima specijacije metala u tragovima. Ova metodologija je poznata i pod nazivom određivanje *kapaciteta kompleksiranja metala* (KKM). KKM se izražava u ekvivalentima metala s kojima se titrira, odnosno za koji se određuje specijacija. Postupak određivanja sastoji se od dodavanja standardne otopine metala u uzorak i mjerenja strujnog odziva sve dok nagib krivulje ovisnosti struje vrha vala labilnog metala o koncentraciji dodanog metala ne postane konstantan (Sl. 3).

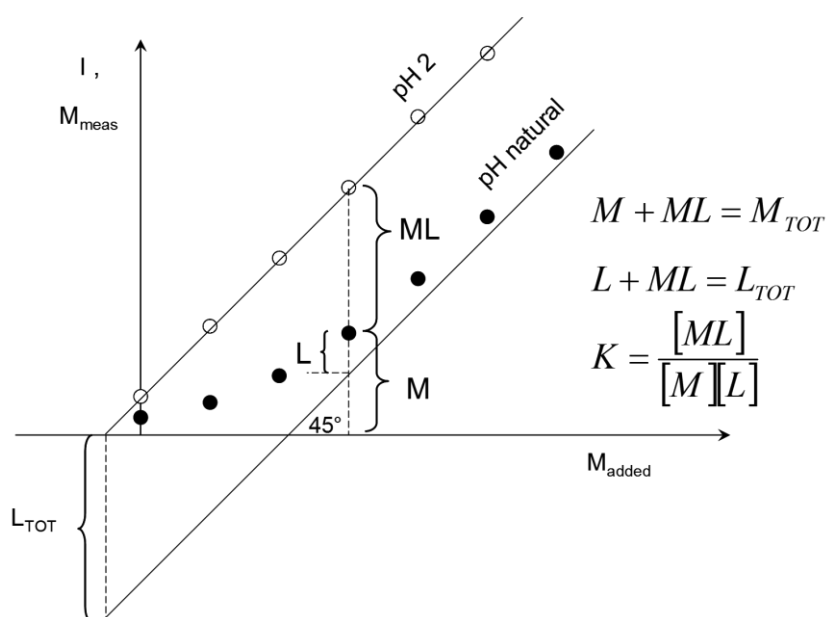

Slika 3. Princip određivanja kapaciteta kompleksiranja metala.

Dobivena titracijska krivulja interpretira se Ružić-van den Berg-ovom linearizacijskom ili transformacijskom metodom (Ružić, 1982; Van den Berg, 1982; Gerringa et al, 1995) na temelju koje se, uz pretpostavku prisustva jedne ili dvije vrste liganada, određuje kapacitet kompleksiranja i prividna konstanta stabilnosti.

1.4. „In-situ“ specijacija - difuzijski gradijent u tankom filmu (DGT)

Tehnika pasivnog uzorkovanja i „in-situ“ specijacije metala, difuzijski gradijent na tankom filmu (DGT) (Davison and Zhang, 1994, 2012) koristi se za određivanje otopljenih slobodnih iona i labilnih kompleksa metala, za koje se smatra da su organizmima potencijalno biorasploživi. Princip rada je da kompleksi metal difundiraju kroz difuzni gel i vežu se na kompleksirajuću smolu (Sl. 4).

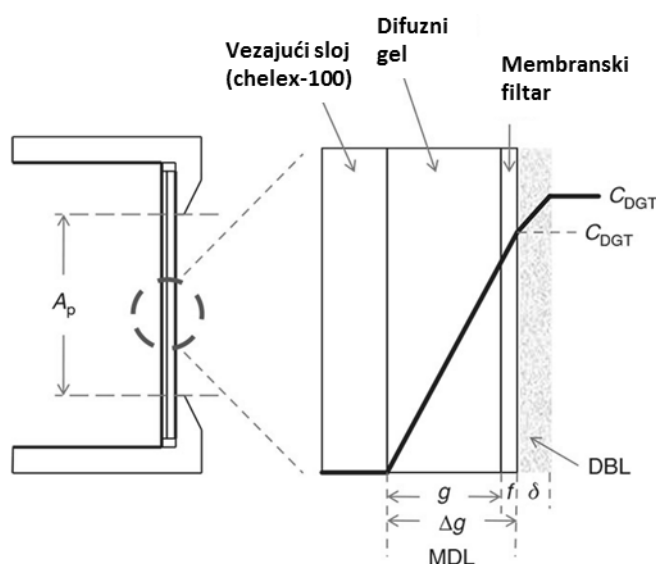

Slika 4. Shematski prikaz DGT uređaja, s uvećanim dijelom koji prikazuje tri karakteristična sloja (Davison and Zhang, 2012).

Korištenjem Chelex-100 gela kao kompleksirajuće smole, DGT uzorkivači se mogu koristiti za određivanje 24 metala važna u okolišu (Garmo et al., 2003). Prednost DGT tehnike je njena „in-situ“ primjena, pri čemu se sprječava promjena specijacije uzoraka, što može biti problem klasičnih specijacijskih analiza koje se provode u laboratoriju. DGT uzorkivači izlažu se u vodeni sustav tijekom određenog vremenskog perioda (od nekoliko dana do ~ 2 mjeseca), a dobivena DGT-labilna koncentracija je prosječna koncentracija tijekom tog vremena (efekt pamćenja).

2. Eksperimentalni dio

Estuarij rijeke Krke nalazi se na istočnoj obali Jadranskog mora. Vodeni stupac ovog estuarija zbog specifičnog položaja i male razlike između plime i oseke koja je karakteristična za Jadransko more je uslojen (postoje boćati sloj, sloj halokline i morski sloj). Koncentracija metala u tragovima u rijeci Krki (Cukrov et al., 2008) i u estuariju (Elbaz-Poulichet et al., 1991) je iznimno niska zbog slabih antropogenih aktivnosti i jakog procesa samopročišćavanja (zbog sedrenih barijera). Posljednjih godina nautički turizam je u porastu, stoga je ovo istraživanje posvećeno antropogenom utjecaju na specijaciju i dinamiku metala i organske tvari u dva različita doba godine (ljet/zima). Porast koncentracije metala u tragovima zabilježen je u okolici grada Šibenika i šibenskoj luci (Omanović et al., 2006) te je povezan s antropogenim zagađenjem. Uočen je antropogeni utjecaj na specijaciju Cu, odnosno na porast koncentracije slobodnog Cu^{2+} (Louis et al., 2009) koji može biti štetan za mikro organizme u estuariju.

Uzorkovanje duž estuarija rijeke Krke (~23 km) izvršeno je na 15 postaja tijekom dva kontrastna perioda, ljet (19.07.2011) i zima (28.02.2012), na tri dubine, u sva tri karakteristična vertikalna sloja, s ciljem određivanja koncentracije i ponašanja metala u tragovima u vodenom stupcu (Sl. 5). Dubine na kojima su se uzimali uzorci određene su nakon mjerenja fizikalno-kemijskih parametara u vodenom stupcu (salinitet, otopljeni kisik, pH, temperatura, fitoplanktonska aktivnost). Boćati sloj uzorkovan je direktno u „teflonske“ boce visoke kvalitete (FEP, PFA) koje su oprane prema proceduri propisanoj za čišćenje boca za analizu metala u tragovima, a za uzorke s ostalih dubina korišten je horizontalni uzorkivač tipa *van Dorn* (2.2 L). Dodatno uzorkovanje boćatog sloja (40 postaja) provedeno je u Šibenskom zaljevu (20.07.2012.) te na 10 postaja poprečnog profila (30.08.2013.). Uzorkovanjem površine određeni su mogući izvora zagađenja, koji bi mogli imati utjecaj na raspodjelu metala u tragovima duž estuarija.

S obzirom na određenu koncentraciju i raspodjelu metala u tragovima u estuariju, izabrane su dvije postaje koje su predstavljale „čisto“ (postaja Martinska) i „onečišćeno“ (marina Mandalina) područje. Na ovim postajama, detaljnije su proučavani fizikalno-kemijski parametri u stupcu vode, kao i raspodjela metala u tragovima te njihova specijacija tijekom dva kontrastna perioda (ljet/zima) tijekom nekoliko godina (08.07.-12.07.2009; 30.01.-04.02.2010; 19.07.-24.07.2010; 13.07.-18.07.2011; 01.03-06.03.2012)

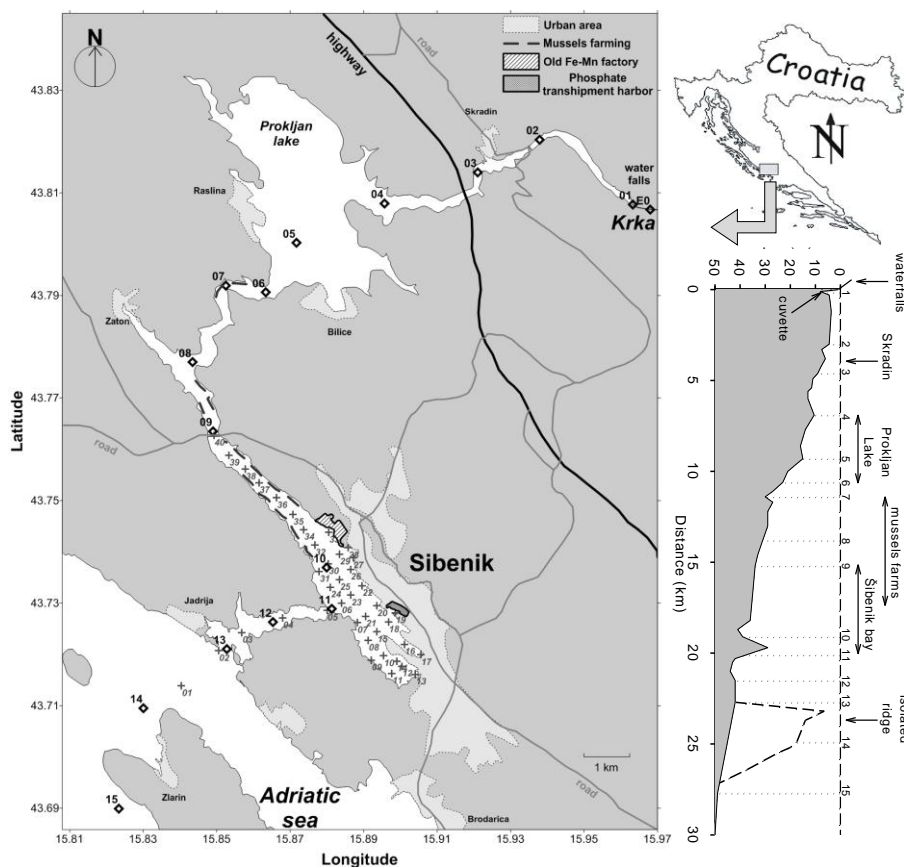

Slika 5. Mapa estuarija rijeke Krke s označenim postajama transekta (◇) i detaljnog mapiranja (+).

Specijacija/frakcionacija metala u tragovima određena je korištenjem dviju komplementarnih tehnika: voltametrije anodnog otapanja i difuzijskog gradijenta na tankom filmu (DGT). Na temelju mjerenja vertikalnog profila saliniteta više puta tijekom ~ 48h određeno je šest dubina na kojima su postavljeni DGT uređaji. Oni su postavljeni u triplikatu na po dvije dubine u svakom sloju (boćati sloj/haloklina/morski sloj) tijekom cca. 5 dana. Korištene su dvije vrste DGT-a, oni s porama veličine 2-5 nm (OP-DGT) i oni sa manjim porama ~1 nm (RP-DGT).

Nekoliko puta tijekom svakog dana mjereni su fizikalno-kemijski parametri u stupcu vode, s ciljem određivanja trenda gibanja vertikalne vodene mase (npr. promjene u salinitetu na svakoj dubini na kojoj su postavljeni DGT uređaji). Kako bi se umanjio utjecaj plime, vjetra ili valova, na održavanje dubine na koju su postavljeni DGT uređaji, pripremljena je posebna konstrukcija temeljena na principu “zračnog” protu-utega. S ciljem usporedbe dviju metodologija za specijaciju metala, tijekom perioda izlaganja DGT-a, ronilac je svaki dan (dva puta ljeti, jedan puta zimi) uzimao uzroke vode na dubinama na kojima su postavljeni DGT uređaji.

U laboratoriju su potom pripremljeni kompozitni uzorci - filtrirani (otopljeni metali u tragovima) i nefiltrirani (ukupni metali u tragovima). Dio uzoraka iz kojih se određivala otopljena i ukupna koncentracija (Zn, Cd, Pb, Cu, Ni i Co) zakiseljen je sa HNO₃ s.p. na pH < 2 i izložen UV svjetlu kako bi se razorila organska tvar. Uzorci u kojima se određivala specijacija Cu, su filtrirani i ostavljeni pri prirodnom pH konzervirani samo s 1 M NaN₃.

Za određivanje otopljenog (DOC) i partikulatnog (POC) organskog ugljika koristio se stakleni sustav za filtriranje s vakuum pumpom i stakleni filter od 0.7 μm (prethodno izvagan). Uzorci za određivanje DOC konzervirani su dodatkom 25 μl 1M NaN₃ i čuvani na 4°C. POC je određen iz količine uzorka koja zaostane na filteru nakon filtracije. Koncentracija suspendiranih čestica (SPM) određena je iz razlike mase filtera prije i nakon filtracije. Za analizu DOC i POC korišten je TOC-V_{CSH} analizator (Shimadzu).

Autolab (Methrom/EcoChemie) potenciostat/galvanostat u kombinaciji s troelektrodnim sustavom 663 VA Stand (Metrohm) i sustavom za automatsko doziranje korišten je za elektrokemijska mjerenja. Viseća živina kap poslužila je kao radna elektroda, kao referentna Ag|AgCl|sat. NaCl, a kao protuelektroda Pt žica. Koncentracije metala određene su metodom standardnog dodatka: Zn, Cd, Pb, Cu diferencijalno pulsnom voltammetrijom anodnog otapanja (DPASV), a Ni i Co diferencijalnom pulsnom adsorptivnom voltammetrijom katodnog otapanja (DPAdCSV) uz dodatak Nioxima (10⁻⁵ M).

DGT uređaji su korišteni prema uputama proizvođača (DGT-Research). Koncentracija metala akumuliranih na Chelex-100 gelu, nakon ekstrakcije u kiselinu određena je na masenom spektrometru visoke rezolucije s induktivnom spregnutom plazmom (HR ICP MS Element 2, Thermo Finnigan). Efektivni difuzijski koeficijenti koji su potrebni za izračun DGT labilne koncentracije zbog specifičnosti sustava (postojanje tri različita vodena sloja) određeni su laboratorijskim pokusom.

DPASV je korištena za određivanje kapaciteta kompleksiranja Cu (KKCu). Kompleksometrijska titracija sastojala se od mjerenja početne koncentracije Cu u uzorku i potom 15 dodataka Cu, tijekom 23 sata provedbe eksperimenta. Boratni pufer (0.01 M) je dodan za održavanje stabilnog pH otopine tijekom provedbe eksperimenta (8.2 ± 0.1). Za obradu podataka korišten je program ProMCC, razvijen u matičnom laboratoriju (Laboratorij za fizičku kemiju tragova) (Omanović et al., 2015). Visual MINTEQ v3.0 korišten je za izračun, tzv. „side reaction“ koeficijenta (α_{Cu}).

3. Rezultati i rasprava

3.1. Osnovni fizičko-kemijski parametri estuarija rijeke Krke

Hidrološki uvjeti u rijeci Krki variraju i najviše ovise o vremenskim uvjetima (kišni periodi). Najviši su protoci, izračunati iz podataka za duži vremenski period (2008-2014), zimi ($80\text{--}90\text{ m}^3\text{s}^{-1}$), a ljeti su značajno manji ($< 10\text{ m}^3\text{s}^{-1}$). Tijekom perioda uzorkovanja, relativno niski protoci bili su u ljeto 2011 i 2012. U estuariju je koncentracija SPM izrazito niska, no moguće je uočiti razliku u njenoj raspodjeli u sva tri sloja (Sl. 6A). U bočatom sloju koncentracija raste prema moru (od $\sim 0.4\text{ mgL}^{-1}$ do $\sim 3\text{ mgL}^{-1}$), a u morskome sloju raste u smjeru prema kopnu (od $\sim 3\text{ mgL}^{-1}$ do $\sim 6\text{ mgL}^{-1}$). U haloklini koncentracija SPM nalazi se između ova dva trenda, a transport u morskome sloju utječe na vertikalni profil SPM duž estuarija.

Vertikalni profili saliniteta pokazali su dobro definiranu stratifikaciju u vodenom stupcu (Sl. 6B). Definirana i oštra haloklina, posebno je bila uočljiva u prvoj polovici estuarija, na dubini 2 do 3 m, a njena debljina se progresivno povećavala u smjeru mora (od ~ 0.4 do ~ 2 m).

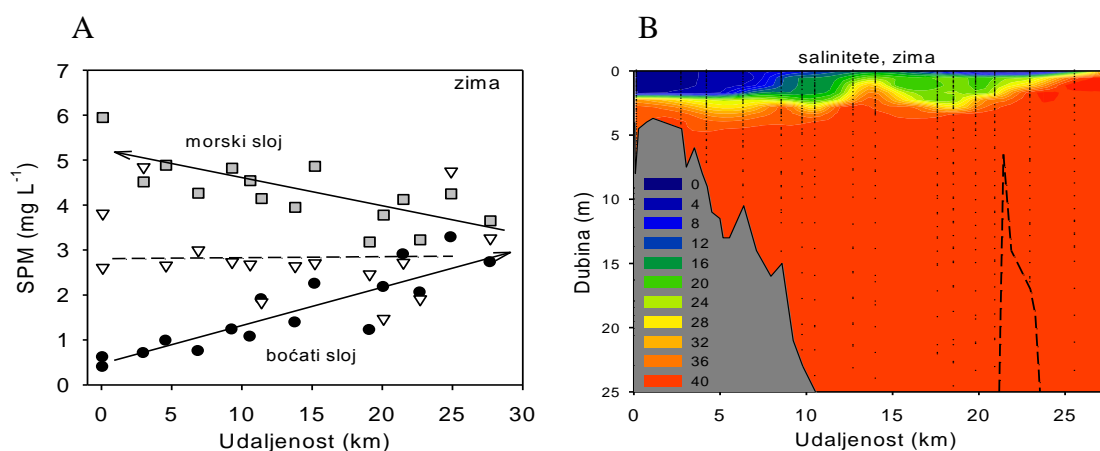

Slika 6. A - ovisnost suspendirane partikulatne tvari (SPM) u sva tri vertikalna sloja, i B - vertikalna raspodjela saliniteta u cijelom estuariju (zimsko uzorkovanje)

Koncentracije otopljenog organskog ugljika relativno su niske i kreću se od 0.4 mg L^{-1} u zimi do 1.8 mg L^{-1} ljeti. Dobiveni rezultati za otopljeni organski ugljik (DOC) ukazuju na ne-konzervativno ponašanje koje je više izraženo ljeti nego zimi uslijed pojačane biološke aktivnosti. Upravo biološka aktivnost rezultirala je i povećanom koncentracijom, ali i udjelom partikulatnog organskog ugljika u ljetnim mjesecima.

3.2. Raspodjela i ponašanje metala u estuariju rijeke Krke

Rezultati mjerenja pokazali su da su koncentracije metala u tragovima niže u rijeci Krki nego u čistoj morskoj vodi, što je neuobičajena situacija jer većina Mediteranskih rijeka ima znatno veću koncentraciju metala nego morska voda. Detaljno istraživanje u području Šibenskog zaljeva pokazalo je da su koncentracije metala u tragovima povećane u području luke i nautičke marine (Sl. 7A).

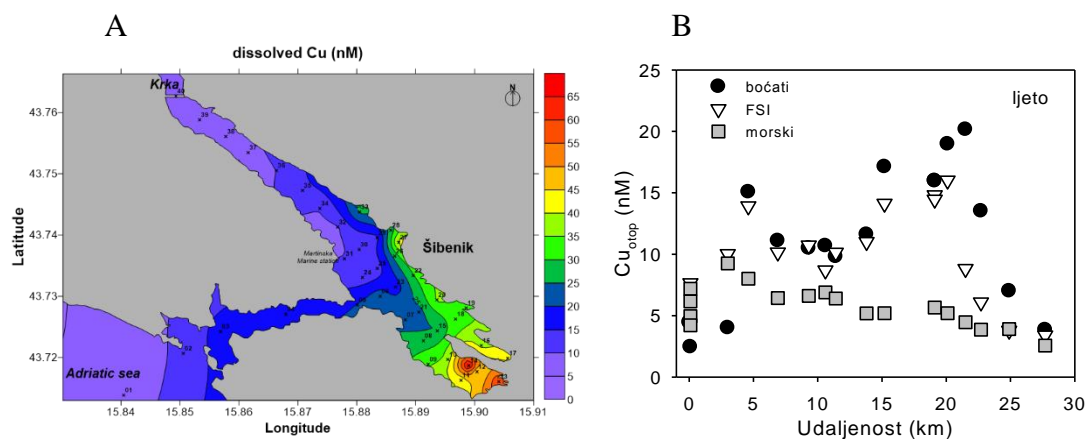

Slika 7. A – raspodjela otopljenog bakra površinskom sloju vodenog stupca u Šibenskom zaljevu; B – prostorna raspodjela Cu u estuariju rijeke Krke (sva tri sloja, ljeto)

Koncentracije metala u tragovima uglavnom su više u ljetnom periodu što se može povezati sa povećanom nautičkom aktivnošću u estuariju, odnosno otpuštanjem metala (posebice Cu i Zn) iz protuobraštajnih boja s kojima su premazana plovila. Najviše vrijednosti koncentracija Zn, Cu, Cd i Pb u površinskom sloju zabilježene su u području Šibenskog zaljeva (15-20 km). Za većinu metala uočen je porast koncentracije u morskom sloju u uzvodnom smjeru, što se povezuje s njihovom akumulacijom u tom sloju i s duljim vremenom zadržavanja vode morskog sloja (Sl. 7B).

U estuariju rijeke Krke za većinu metala u tragovima uočeno je ne-konzervativno ponašanje u horizontalnom gradijentu saliniteta s obzirom na dvije krajnje lokacije uzorkovanja (tzv. „end-members“), što je uglavnom posljedica unosa metala u estuarij u području Šibenskog zaljeva. Od mjesta unosa, koncentracija metala se očekivano smanjuje nizvodno (efekt razrjeđenja), ali također i uzvodno, što se može objasniti vertikalnim transportom metala u tragovima u dublje slojeve te njihovog transporta morskim slojem ispod halokline koji se kreće u obrnutom smjeru, tj. uzvodno. U morskom sloju dolazi do povećanja koncentracije gotovo svih metala, što se može objasniti hidrodinamičkim odnosno fizičko-kemijskim modelom.

Koncentracija metala u tragovima u partikulatnoj frakciji (osim Pb) u većini uzoraka je ispod 10%. Nešto je veća ta koncentracija u ljetnom periodu u odnosu na zimski, no to se može povezati sa različitom prirodom SPM-a. U ovom je radu predložen model konzervativnog ponašanja koeficijenta distribucije (K_D) u ovisnosti o koncentraciji partikulatne tvari. Za Zn, Cd i Co utvrđena su negativna odstupanja od predloženog teoretskog modela ponašanja za rezultate zimskog uzorkovanja, dok su rezultati za ljetno uzorkovanje pokazali pozitivno odstupanje za sve metale.

3.3. Primjena DGT tehnike za „in-situ“ specijaciju metala u tragovima

DGT tehnika korištena je za određivanje specijacije metala u tragovima, odnosno njihove potencijalno biorasploživu koncentraciju, u vertikalnom gradijentu saliniteta estuarija rijeke Krke tijekom 3 ljetna i 2 zimska perioda. Tijekom izloženosti DGT uređaja na određenim dubinama uzimani su i diskretni uzorci vode iz kojih su potom napravljeni kompozitni uzorci. Prva serija uzorkovanja u ljeto 2009 obuhvaćala je i usporedbu dva kontrastna područja označenih kao „čisto“ i „onečišćeno“. Rezultati vertikalnih raspodjela otopljenih i DGT-labilnih koncentracija metala u tragovima (Zn, Cd, Pb, Cu, Ni, Co) na „čistoj“ i „onečišćenoj“ postaji jasno pokazuju povišene koncentracije metala, posebice Cu i Zn na potonjoj lokaciji.

S obzirom na različit sastav vode u kojima su bili izloženi DGT uređaji, različit salinitet, bilo je potrebno provjeriti difuzijske koeficijente metala u primijenjenim DGT uređajima. Određivanja efektivnog difuzijskog koeficijenta istraživanih metala u tragovima provedeno je u kontroliranim laboratorijskim uvjetima, u sastavu otopina koji odgovaraju slatkoj, slanoj i vodi srednjeg saliniteta. Dobiveni rezultati pokazali su relativno dobro slaganje s literaturnim vrijednostima.

Iz glavnih značajki vertikalnih profila svakog metala vidljivo je da su profili za otopljene i DGT-labilne frakcije uglavnom sukladni, te da je prema očekivanjima DGT-labilna koncentracija manja od otopljene. Slika 8 prikazuje tipični primjer dobivenih profila. Uočeni problemi s primjenom ove tehnike odnosne se uglavnom na Zn, i vezani su za relativno visoke vrijednosti „blanka“. Primjena dva različita tipa DGT uređaja koji se razlikuju po veličini pora difuznog gela, tzv. „open pore“ (OP, ~ 5 nm) i „restricted pore“ (RP, ~ 1 nm) nisu dali rezultate uobičajene za riječne sustave (manje DGT-labilne koncentracije određene s RP; razlikovanje veličinski različitih organskih kompleksa metala), odnosno dobivene su gotovo istovjetne vrijednosti, što je također posljedica specifičnosti estuarija rijeke Krke.

Pokazano je da se pomoću DGT tehnike određuje samo dio od ukupne koncentracije metala, što je operativno nazvano DGT-labilna koncentracija, i da je udio DGT-labilne koncentracije različit za pojedini metal (gotovo 100% Cd je DGT labilno, za razliku od 20-40% Cu), te da ovisi primarno o interakciji metala s prirodnom organskom tvari, odnosno o stabilnosti/jačini organskih kompleksa (Sl. 9).

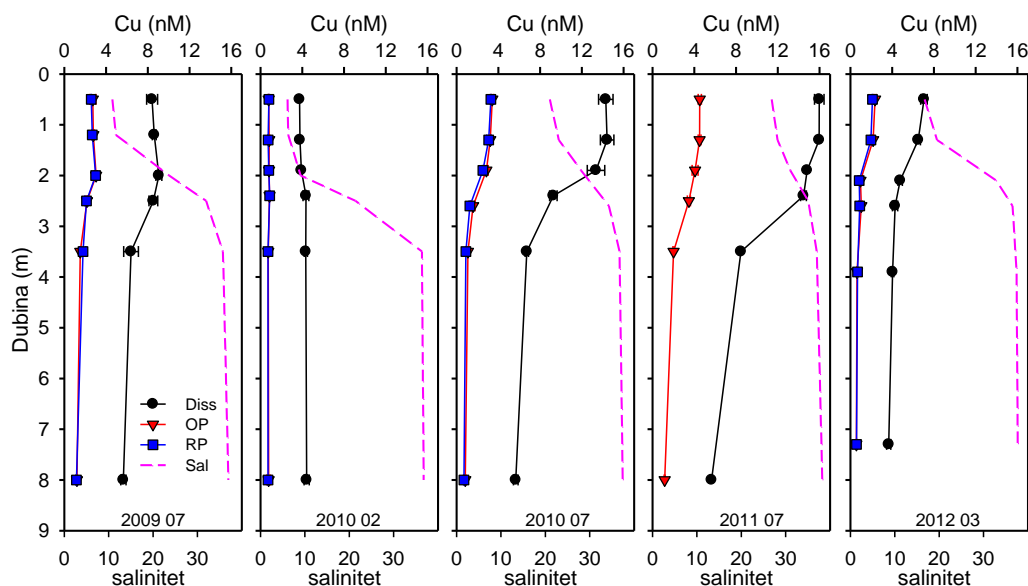

Slika 8. Vertikalni profili otopljenog te DGT-labilnog Cu na postaji Martinska.

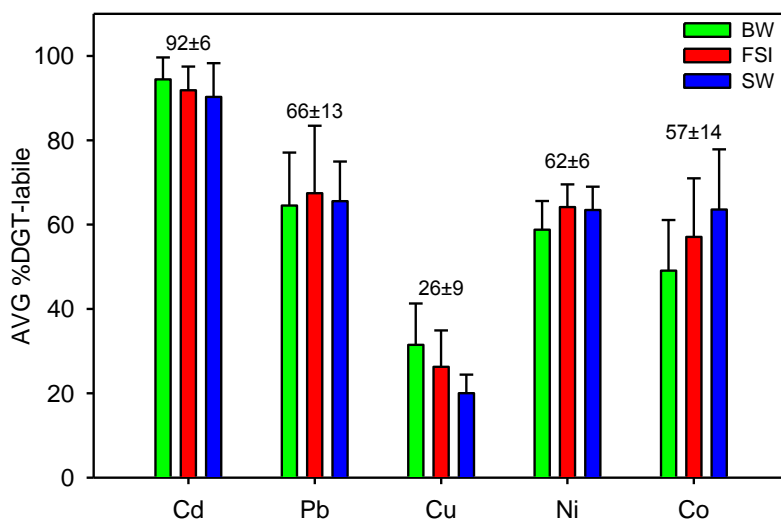

Slika 9. Srednja vrijednost postotka DGT-labilnih metala za svaki pojedinačni vertikalno odvojeni sloj. Brojevi iznad stupića prikazuju sveukupnu srednju vrijednost (sve dubine).

3.4. Primjena elektrokemijske tehnike za specijaciju bakra

Primjenom metode određivanja kapaciteta kompleksiranja voltametrijom s anodnim otapanjem (ASV) utvrđeno je da bakar (Cu) s organskim ligandima stvara dva tipa kompleksa (CuL_1 i CuL_2), pri čemu CuL_1 kompleksi imaju veću prividnu konstantu stabilnosti, a koncentracija raspoloživih liganada je niža nego za drugi tip kompleksa (Sl. 10). Temeljem parametara kompleksiranja dobivenih iz opisanih pokusa, izračunato je da je koncentracija slobodne (hidratizirane) vrste bakra (Cu^{2+}) u vodenom stupcu (vrsta koja se smatra najviše bioraspoloživom, a time i toksičnom) uglavnom iznad granične vrijednosti od 10 pM.

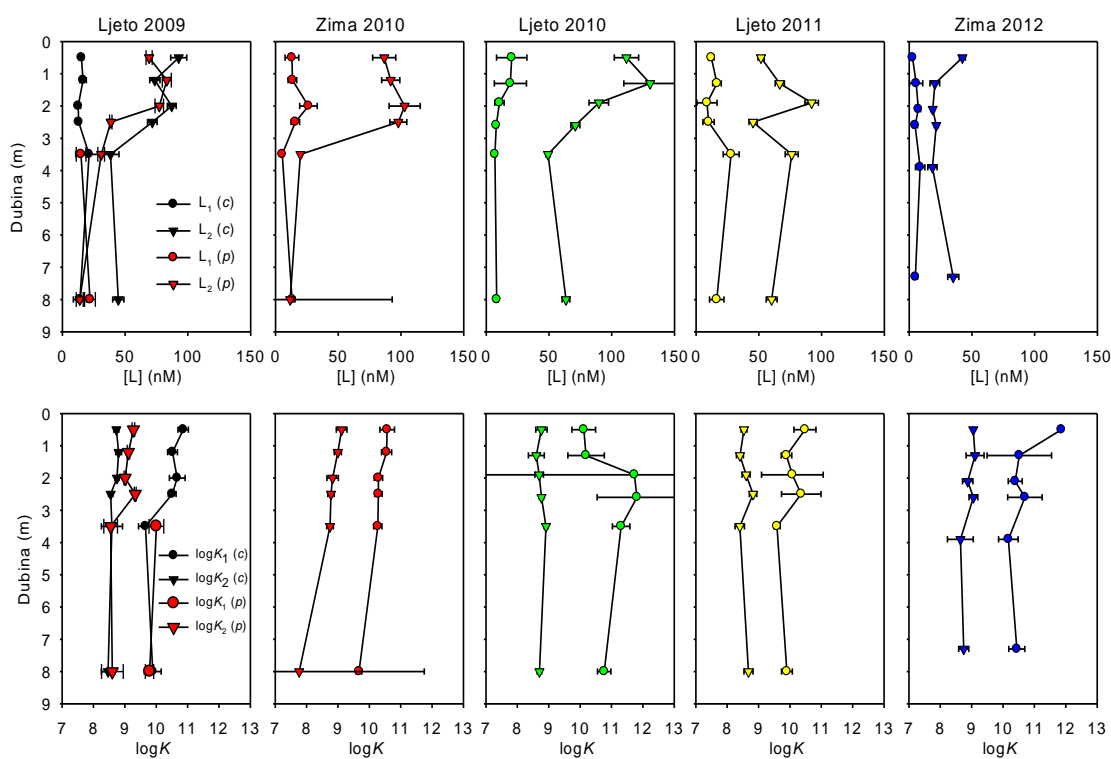

Slika 10. Vertikalni profili koncentracije i prividne konstante stabilnosti jakog ($[\text{L}_1]$, $\log K_1$) i slabog ($[\text{L}_2]$, $\log K_2$) liganada za sve provedene eksperimente. „c” i „p” označavaju „čistu” odnosno „onečišćenu” lokaciju.

Usporedbom rezultata koncentracije DGT- i ASV-labilnog Cu određene pomoću ove dvije tehnike, utvrđeno je vrlo dobro slaganje trendova, s razlikom da su pomoću ASV metode određene niže vrijednosti, što je u skladu s karakteristikama tih tehnika (Sl. 11). Neravnotežne tehnike koje su korištene u ovom radu ASV i DGT imaju karakteristične kinetičke prozore (*“kinetic window”*) (van Leeuwen et al. 2005). Zbog toga kompleksi metala koji su izmjereni ovim tehnikama ovise o termodinamičkim svojstvima (odnos

metal/ligand), ali i o operativnim vremenskim skalama određenih tehnika (kinetička svojstva) (van Leeuwen et al., 2005; Town et al., 2009; Plavšić et al., 1980). Stoga se koncentracije izmjerene ovim tehnikama smatraju operativnima i nazivaju DGT-labilnima ili ASV-labilnima. Prednost korištenja DGT tehnike u odnosu na ASV tehniku je što ona omogućava *in-situ* mjerenje labilnih metalnih specija tijekom vremena izloženosti, u odnosu na ASV kojom se analizira diskretni uzorak, ali ASV s druge strane daje puno više podataka o interakciji metala s organskim ligandima.

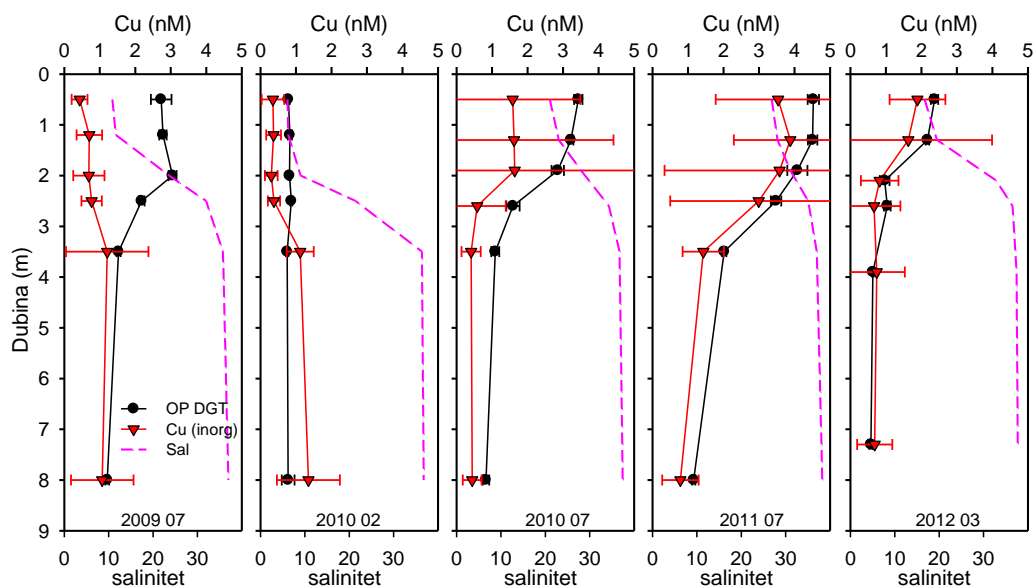

Slika 11. Usporedba reaktivnih koncentracija Cu dobivenih s OP DGT i ASV tehnikom.

3.5. Usporedba dvije lokacije: „čista“ vs. „onečišćena“

Najveći porast koncentracije na "onečišćenoj" postaji u marini u odnosu na "čistu" postaju Martinska, opažen je za Cu. Intenzitet povećanja smanjuje se s dubinom i bio je veći za DGT-labilne nego za otopljene koncentracije Cu ($\sim 6\times$ vs $4\times$ na površini). Relativno visoke koncentracije Cu u boćatom sloju ($32 \text{ nM Cu}_{\text{diss}}$) i niže u morskom sloju ($16 \text{ nM Cu}_{\text{diss}}$) su očekivane, jer se postaja nalazi u području marine. Povećane koncentracije Cu su posljedica ispiranja Cu iz protuobraštajnih boja. Dobiveni su usporedivi vertikalni profili otopljenih i DGT-labilnih koncentracije Cu.

Puno bolje slaganje između vertikalnih profila između DGT i ASV-labilnih koncentracija Cu dobiveno je na „onečišćenoj“ postaji nautičke marine (Sl. 12), što je uglavnom posljedica viših koncentracija Cu. Manji udio ASV-labilnog Cu je i očekivan zbog kraćeg „kinetičkog prozora“. Efektivno vrijeme mjerenja za ASV je 0.1 s , uz debljinu difuzijskog sloja od $10 \mu\text{m}$, i koeficijenta difuzije $5 \times 10^{-6} \text{ cm}^2 \text{ s}^{-1}$, dok je u uređaju DGT debljina difuzijskog sloja

0.9 mm, efektivno vrijeme mjerenja je 13.5 min (Zhang and Davison, 2000). Važnost debljine difuzijskog sloja za operativno određivanje labilnosti metalnih kompleksa i njihov kinetički doprinos kod ASV, već je objašnjeno u mnogim radovima (Plavšić et al., 1980; Lovrić et al., 1984; van Leeuwen et al., 2007, Grad et al., 2009).

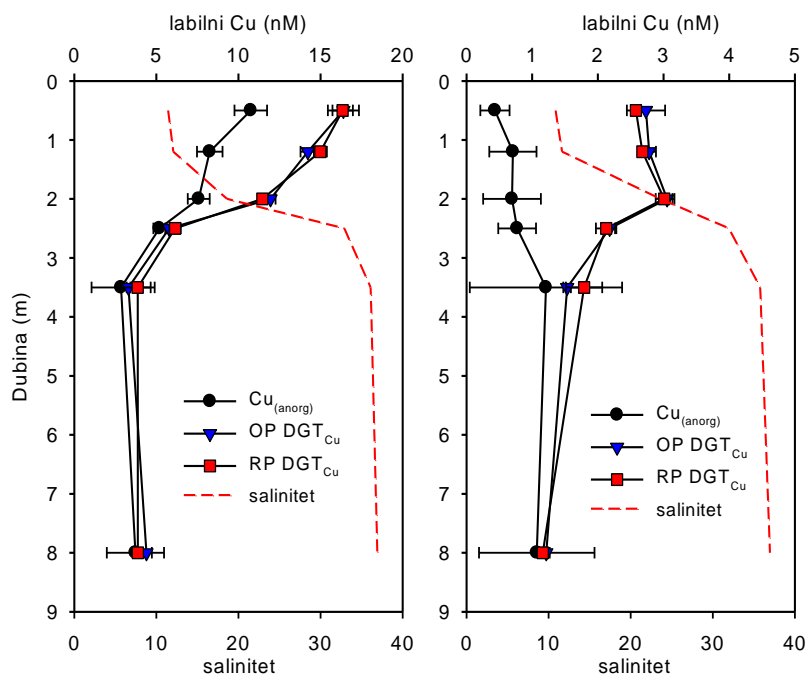

Slika 12. Usporedba koncentracija labilnog Cu određena elektrokemijskom (ASV-labilni) i DGT tehnikom (DGT-labilni) na „onečišćenju“ (lijevo) i „čistoj“ (desno) postaji.

Poznata je uloga Cu u prirodnim vodama u odnosu na njegovu bioraspoloživost/toksičnost prema vodenim organizmima (Fichet et al., 1998; Santore et al., 2001; Ytreberg et al., 2011), stoga je važno pratiti koncentraciju otopljenog Cu u sustavima poput estuarija. No još je važnije poznavati specijaciju Cu, pogotovo zbog porasta otopljenog Cu u kombinaciji sa niskom koncentracijom DOC-a u estuariju rijeke Krke, pri čemu može doći do porasta biodostupne frakcije (slobodni ioni) i prelaza toksične granice od 10 pM za neke morske organizme (Sunda et al., 1987) kao što je 2009 pokazao Louis u svom radu (Louis et al., 2009a). No organski ligandi koji imaju visoki afinitet za vezanje Cu dominiraju u specijaciji otopljenog Cu (Buck et al., 2007). Ti organski ligandi vežu > 99.9 % otopljenog Cu i učinkovito utječu na sustav, sprječavajući utjecaj malih promjena koncentracija otopljenog Cu i održavajući koncentracije slobodnog Cu²⁺ ispod granice toksičnosti u odnosu na vodene mikroorganizme.

4. Kratki rezime i zaključci

Raspodjela i specijacija odabranih metala u tragovima (TM) (Zn, Cd, Pb, Cu, Ni i Co), te njihovo ponašanje i sudbina istraživani su u vodenom stupcu vertikalno uslojenog estuarija rijeke Krke tijekom dva kontrastna godišnja doba (ljetno/zimno) u periodu od 2009 do 2013. Istraživanja su obuhvaćala i mjerenja otopljenog/partikulatnog organskog ugljika (DOC/POC), te osnovnih fizičko-kemijskih pokazatelja (salinitet, pH, otopljeni kisik, temperatura), a uzorkovanja su provedena u tri karakteristična sloja (boćati, međusloj i morski). Voltametrija s akumulacijom (anodna i adsorptivna katodna) bila je primarna analitička tehnika, dok je za specijaciju korištena i komplementarna tehnika pasivnog uzorkovanja temeljena na principu difuzijskog gradijenta u tankom filmu (DGT).

Koncentracije TM niže su u rijeci Krki nego u vodi otvorenog dijela Jadrana, što je omogućilo identifikaciju puteva i procesa koji reguliraju horizontalnu i vertikalnu preraspodjelu TM u cijelom estuariju. Nekonzervativno ponašanje u površinskom sloju estuarija uočeno za većinu TM uzrokovano je primarno unosom metala u području Šibenskog zaljeva. Detaljno „mapiranje“ zaljeva pokazalo je da su luka i nautička marina područja s najvišom koncentracijom TM. Pokazalo se da je značajan porast Cu i Zn u cijelom estuariju tijekom ljetnih mjeseci u izravnoj vezi s pojačanom nautičkom aktivnošću, odnosno vezani su za otpuštanje metala iz protuobraštajnih boja s plovila. Vertikalni transport TM u dublje slojeve („scavenging“), te dulje vrijeme zadržavanja morske vode uzrokovali su uzvodni porast koncentracije TM u morskom sloju.

Vrlo dobro slaganje vertikalnih profila DGT-labilnih i otopljenih koncentracija TM ukazuju da se DGT tehnika može uspješno koristiti za određivanje potencijalno bioraspoloživih koncentracija TM u estuarijskim uvjetima. Udio DGT-labilnih TM odraz je njihove kemijske specijacije (primarno vezanja s prirodnim organskim ligandima), te varira od > 90% za Cd, do < 20% za Cu, ali ovisan je također i o omjeru koncentracije metala i organskih liganada. Voltametrijska specijacija Cu pokazala je prisutnost dva tipa organskih liganada koji stvaraju jake (L_1 , $9.6 < \log K_1 < 11.9$) odnosno slabe (L_2 , $7.8 < \log K_2 < 9.9$) Cu komplekse. Koncentracija slabijih organskih liganada (L_2) u korelaciji je s koncentracijom DOC-a, te je veća ljeti najvjerojatnije zbog povećane biološke aktivnosti. Koncentracija slobodnih iona Cu (vrsta koja je najviše bioraspoloživa) pri okolišnim uvjetima regulirana je u većoj mjeri kompleksiranjem s jakim ligandima (L_1). Za većinu uzoraka izračunate vrijednosti slobodnog Cu blago prelaze graničnu toksičnu vrijednost od 10 pM, međutim, te vrijednosti su rezultat upotrijebljenog načina izračuna i ne odražavaju nužno stvarno stanje.

1. Introduction

1. Introduction

Trace metals are non-degradable constituents present in aquatic environments, unlike organic compounds, which undergo degradation by biological or chemical processes. Metal pollution can occur in rivers, estuaries, and coastal zones by anthropogenic sources like industry, traffic, agriculture, waste waters disposals, fossil fuel burning, and tourism. Natural concentrations of trace elements that are of prime environmental concern are very low, so the lower the actual metal concentrations is, the more critical for the ecosystem is even small anthropogenic metal additions. The research focus is generally directed toward metals having known biological functions (e.g. Fe, Cu, Zn, Co) or being highly toxic (e.g. Hg, Cd, As, Cr). Due to their very low concentrations in natural waters, reliable analytical determination of trace metals demands expert knowledge and experience.

The total metal concentration in an aquatic environment is essentially distributed between particulate and dissolved forms. This fractionation is purely operational and is defined by the filter cut-off (0.45 or 0.2 μm). An approved fundamental statement is that the reactivity, transport, bioavailability and/or toxicity for micro-organisms in natural waters are dependent on the speciation of trace metals (Tessier and Turner, 1996). Metals such as iron (Fe), zinc (Zn), copper (Cu), nickel (Ni), and cobalt (Co) are the essential micronutrients for marine phytoplankton, which control primary productivity. Consequently, these metals have a major influence on the global carbon cycle and thus play a key role in regulating global climate. However, the availability of these metals to the biota is governed by the distribution of their chemical forms, i.e. speciation, whereby trace metals are bound by organic ligands that may reduce or enhance metal bioavailability, depending on the metal and the resulting metal-ligand complex. Organic ligands are defined as molecules that can bind to, and form a stable complex with, trace metals in the dissolved phase (typically $<0.45 \mu\text{m}$ or $<0.2 \mu\text{m}$). So, the total metal concentration, as well as its speciation, is of utmost interest.

Understanding the behaviour, fate, and impact of trace metals on the natural ecosystems is of great interest, even if it is still very complex due to the numerous factors controlling their biogeochemistry, especially in estuarine environments where a large difference in water composition exists, which influences both physical and chemical changes of the trace metal distribution and speciation (Muller et al., 1996). In estuaries, partitioning and speciation of trace metals, are influenced by changes in the physical parameters and biological activity, through different processes like complexation, sorption, absorption, flocculation, precipitation, and dissolution. Trace metal behaviour in estuaries is complex, and its gradient

is ascribed to the relationship between concentration and conservative parameters, such as salinity. Depending on the metal characteristics, as well as the physico-chemical, hydrodynamic and environmental (e.g. pollution) conditions, conservative and non-conservative behaviour may occur. Non-conservative behaviour of trace metals in the mixing zone of the estuary, occurs due to variations in ionic strength, adsorption and biological input.

In natural waters, the inorganic speciation of elements is known and predictable, and the challenging task is to understand the interactions between metals and natural organic matter (NOM) (either of mainly terrestrial (coastal regions), or autochthonous origin, produced by micro-organisms in the water column) (Bruland et al., 2004). Due to the very low concentration of metals in seawater, (down to pM level) and experimental limitations in separating, extracting and measuring the different metal complexes (defined by the detection limit), an alternate, indirect approach for the characterization of metal-organic ligand interactions is usually practiced. It is based on the titration of the sample, with the target metal at the natural pH (Bruland et al., 2004). The most widely spread are the electrochemical techniques because of their good selectivity and high sensitivity: anodic stripping voltammetry (ASV) (Plavšić et al, 1982; Omanović et al., 1996; Garnier et al., 2004) and competitive ligand exchange adsorptive cathodic stripping voltammetry (CLE-AdCSV) (van den Berg, 1989; Buck et al., 2012). As a result of electrochemical titration, a set of complexation parameters, ligand concentrations (L_i), and conditional stability constants (K'_i), are obtained, and further used for the calculation of trace metal speciation.

An alternate speciation methodology in recent years has been the technique of passive sampling that is based on the diffusion gradients in thin film (DGT) (Davison and Zhang, 1994, 2012). It is a robust technique that is used to determine the dissolved free metal ions and labile metal complexes, which represent potentially bioavailable metal forms. By using Chelex-100 as a binding resin, DGT can determine 24 elements, among which Pb, Zn, Co, Ni, Cu, Cd, Al, Mn, Fe, Cr and U are of environmental significance (Garmo et al., 2003). There are a few studies in which the DGT technique is used for trace metal speciation in estuaries (Dunn et al., 2007; Warnken et al., 2004; Forsberg et al., 2006). The advantage of using the DGT technique is its *in-situ* application. In this way, the change in original speciation is prevented, which is usually the problem in classical speciation analysis in laboratories. In addition, as the DGTs are deployed over an extended period of time (from a few days to approximately two months), the obtained DGT-labile concentration is the average concentration during the deployment

period (memory effect). This overcomes the problem of, e.g. episodic contamination, which could not be spotted by the classical discrete sampling/speciation methodology.

Objectives and scope of the work

The objective of this work is to explore the influence of the variable physico-chemical conditions that exist in stratified estuaries (like the Krka River estuary) submitted to seasonal anthropogenic pressure by touristic boat traffic (e.g. antifouling paint, sacrificial anode), on the behaviour and fate of trace metals. By combining different analytical and modelling tools (e.g. sample titration, with additions in logarithmic mode and voltammetric measurement of the labile metal fraction, followed by the modelling of metal/organic matter interactions), the main process controlling spatial/temporal variability of metal content and speciation will be better understood.

Both temporal and spatial field observation studies are expected to provide information on the dynamics of trace metals in the water column. The distribution of metals among particulate and dissolved phases will be examined in relation to the sharp vertical salinity gradient (salinity change about 30 in 0.5 m). To accomplish this goal, the *in-situ* dynamic speciation technique, Diffusive Gradient in Thin films (DGT), will be exploited as a comparative technique to the classical sampling and analysis in the laboratory using electrochemical techniques. Electrochemical techniques, anodic stripping and adsorptive cathodic stripping voltammetry, will be used for analytical purposes. In addition to trace metals, natural organic matter will be characterized by the content of dissolved organic carbon. Due to the very clean water environment, with concentrations of studied metals at the *ppt* level, clean handling and analysis protocols will be strictly followed in all stages of the work. Electrochemical speciation by ASV will be performed for copper by means of titration experiments, from which binding properties of copper with natural organic ligands will be determined (copper complexing capacity).

Detailed field work examinations, laboratory experiments, and speciation modelling should provide answers to some key questions regarding the behaviour of trace metals in the conditions prevailing in stratified estuaries, e.g. the mechanisms of vertical/horizontal transport, the regulation of partitioning in terms of natural/manmade input of trace metals, the identification and characterization of the major components regulating the physical fractionation and chemical speciation of trace metals, and the regulation of trace metal bioavailability.

2. Literature overview

2. Literature overview

2.1. Metals in aquatic environment

Metals are natural constituents of every compartment in the environment. Practically all of the metals from the periodic table occur in broad variety of concentrations and forms in natural waters.

According to concentrations basic classification of metals in the water:

- a) *major components* of seawater - metals in concentrations greater than 1 ppm
- b) *minor components* - metals in concentrations lower than 1 ppm
- c) *trace metals* - metals that occur at picomolar or nanomolar level.

Metals could be essential for organisms as nutrients (Cu, Zn, Ni, Mo, Co) and could become toxic in concentrations when they exceed critical limits. Most of the trace metals are highly reactive and important in biogeochemical cycles.

The toxicity, fate and transport of metals could be determined by their individual physico-chemical properties. To understand their behaviour in the environment it is not enough to know the total concentration. It is important to know in what form metals occur and to understand interdependence of different processes (biological, physical and chemical) in order to predict their behaviour.

2.1.1. Definition of terminology: heavy metals, toxic metals or trace metals

The term “*heavy metals*” is applied to a large group of elements that are biologically and industrially important. For long time this was the most widely used and recognized term for elements, based on their density. According to different density, from 3.5 to 7 g cm⁻³ there can be misunderstandings in definition for heavy metals about which metals are heavy metals. For describing pollutions and toxicity aspect, “heavy metals” term is often used as collective name for a group of elements that are environmentally important.

Another term that is quite often use is “*toxic metals*”. This term is even less appropriate because all trace elements could be toxic to living organisms if they are present in excess, but many of them are essential in small concentrations for the healthy growth of organisms (Cu, Zn, Cr, Mn, Co). The term “*trace metals*” is broad expression that emphasis on quantity more than on specific properties and includes different elements (like semi metals as Sb and As) (Hubner et al., 2010).

2.1.2 Trace metals in natural waters

Most of the metals occur in natural waters at trace levels. Their low concentration in water does not mean that they are present at low levels in rocks. For instance Fe, Ti and Al are present in natural waters as trace elements and in rocks they occur as major elements. Reason for described behaviour is their low mobility at the earth's surface (Gaillardet et al., 2013). Trace elements are sensitive indexes of human impact from local to global scale. That is why it is important to understand the behaviour of trace elements in geological processes, during chemical weathering and transport by waters. By transport processes and weathering trace metals get more fractionated than major elements. That fractionation helps to better understand nature and intensity of these processes.

The amount of trace metals in river depend on their mobility during transport and weathering and their abundances in continental crust. In hydrological system ultimate source of trace metals is continental crust. In the river basin trace metals could come by rock weathering, wet and dry atmospheric deposition or by anthropogenic activities.

Diagram in Fig. 2.1 compiles sources of metals, both natural and anthropogenic, in aquatic environment. The atmospheric input of trace metals is significant, according to abundance of trace metals in rain and aerosol solubility. In hydrological system there are a number of potential point and non-point sources of metal. Since the beginning of the twentieth century, the industrial revolution has caused a drastic increase in the exploitation and processing of metals, resulting in their release into the environment and release of associated elements with no economic value (Gaillardet et al., 2013). Release of metals could be associated with the use of trace metals in water treatment, fertilizers, pharmaceuticals, paints. For many trace metals anthropogenic contributions from different sources far exceed natural levels.

Particles that are transported by large rivers represent complex mixing of primary minerals, clays, carbonates, oxides and biogenic remains. Different studies have confirmed that adsorption processes control the levels of trace elements in large rivers (Shafer et al., 1997; Smedley and Kinniburgh, 2002; Wen et al., 1997).

The determination of concentrations for different trace metals in river water is facilitated in particular by technical advances of ionic coupled plasma mass spectrometry (ICP MS). That technique provides rapid measurement for a large number of metals. It is needed to measure trace metals in order to better understand their behaviour during weathering, transport and for investigating pollution and toxicological studies.

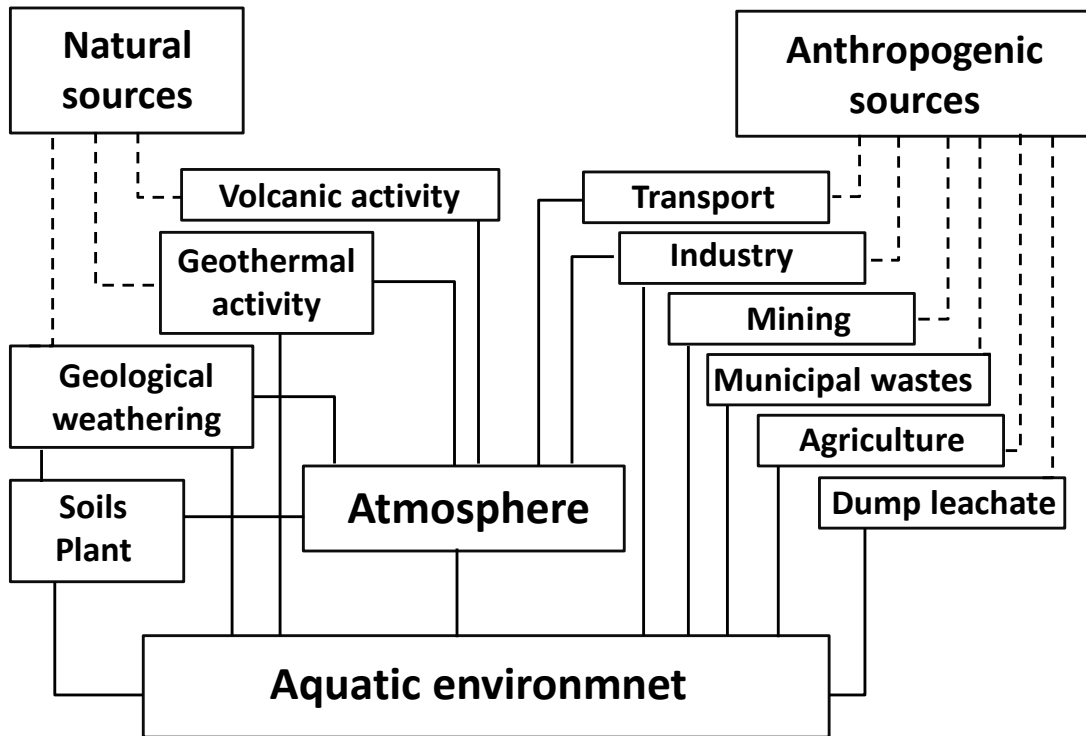

Figure 2.1. Trace metal pathways to the aquatic system (Gaillardet et al., 2013).

In river water concentrations of trace metals span over 10 orders of magnitude, similar to the range of crustal abundances. The abundance of trace metals in river waters depends on their mobility in weathering and transport processes and on continental abundances. Characteristic of trace metals in waters is their dependence on chemical conditions prevailing in the river (Gaillardet et al., 2013). Mobility of trace metals in river waters is result of a complex combination of different factors like their water solubility, the input to the system of no weathering sources like atmospheric or anthropogenic sources, the ability of the elements to be complexed by fine colloidal material and their affinity for solids (co-precipitation, adsorption, solubility equilibrium). Owing to the global present day contamination of the atmosphere by anthropogenic emissions it is not easy to estimate the natural input of trace metals to hydro systems, but rain is significant source of metal transported by the rivers. Dependence of concentration of the trace metals in river water on pH and other chemical variables could be explained by the pH sensitivity of colloids stability in the aquatic system (Elbaz-Poulichet, 2005; Huser et al., 2011; Vasyukova et al., 2012).

Studies in estuaries have shown that flocculation, coagulation and degradation of colloidal material controls the behaviour of metals in the mixing zones between fresh and sea water (Biati and Karbassi, 2010; Biati et al., 2010).

To separate trace metals from major and minor metals in natural waters a concentration of $10 \mu\text{mol L}^{-1}$ is chosen. Trace metals can exist in different physical and chemical forms. The simplest distinction is on *particulate* and *dissolved* forms. This operational definition is based on separation by filters pore sizes ($0.45 \mu\text{m}$ or $0.2 \mu\text{m}$).

In particulate forms metals could be:

- a) adsorbed onto particle surface
- b) incorporated within particles of biogenic origin
 - a. incorporated in the matrix of minerals (i.e. aluminosilicate minerals) or
 - b. co-precipitated on other antigenic minerals.

2.1.3. Trace metals in seawater

The concentrations and distributions of trace metals in seawater are controlled by a combination of different processes, such as external sources of trace metals that are delivered by rivers along sea boundaries, windblown dust from semi-arid and arid continental regions and hydrothermal circulation at mid ocean ridges. Trace metals could be removed from seawater with processes that include active biological uptake and passive scavenging onto living or non-living particulate material (Bruland and Lohan, 2013). Particulate material is usually internally recycled in the water column or in surficial sediments (sink of trace metals is generally marine sediments). The concentration of metals in seawater is ranging over 15 orders of magnitude from most abundant cation like sodium (concentration 0.5 mol L^{-1}) to iridium that is present at much lower concentrations ($\sim 0.5 \text{ f M}$) (Fresco et al., 1985).

In surface seawater, a major fraction of many trace metals, especially those that are bioactive like Zn, Cd, Cu or Co are present as chelates with strong metal-binding organic ligands. Good correlations among trace metals are reported from a number of authors (Hatje et al., 2001; Shynu et al., 2012; 1994; Wallner-Kersanach et al., 2009).

Various soluble complexes and potential colloidal forms are included in dissolved metals. The chemistry and behaviour of many trace metals in the water column is dominated by complexation, biological assimilation at uptake sites on cell surface and adsorption on surface sites of suspended particles (Hering and Morrel, 1990). In seawater trace metals could be grouped in categories according to their distribution and chemical behaviour in seawater column (Bruland and Lohan, 2013):

- 1) **Conservative type.** Metals with this type of distribution interact only weakly with particles. Their oceanic residence time is greater than mixing time of the oceans ($\sim 10^5$ yr.) and concentration is maintaining relatively constant ratio to salinity. These metals are involved in the major biogeochemical cycles of particle formation and destruction.
- 2) **Nutrient type.** Trace metals with distribution of this type are significantly involved in the internal cycles of biologically derived particulate material. Their concentrations are lowest in the surface waters where they are assimilated by phytoplankton or adsorbed by biogenic particles. In the subsurface waters concentrations increase as sinking particles undergo decomposition or dissolution. Aging of water causes increase of concentration along the flow path of water. Their residence type is intermediate from a few thousand to one hundred thousand years.
- 3) **Scavenged type.** Process of surface adsorption that is followed by particle settling is known as scavenging (Turekian, 1977). Characteristic of trace metals with this type of distribution is strong interaction with particles and short oceanic residence time ($\sim 100 - 1000$ yr.). Concentrations tends to be maximal near major sources like atmospheric dust, hydrothermal vents, bottom sediments or rivers. With a distance from the sources concentrations decreasing along the flow path of deep water due to continual particle scavenging.
- 4) **Hybrid distribution.** Several trace metals like copper and iron show distributions that are influenced a lot by recycling and intense scavenging processes.
- 5) **Mixed distribution.** Trace metals that exist in various chemical forms have substantially different distributions.

2.2. Organic matter in natural waters

To describe hydrocarbon compounds of natural origin (other than living organisms) and anthropogenic system the term “organic matter” (OM) is formed. With filtration over $0.7 \mu\text{m}$ glass fibre filter it is possible to distinguish dissolved OM (DOM) from particulate OM (POM). DOM is present in all aquatic environments and creates one of the largest pools of reduced carbon on Earth’s surface (Hedges and Keil, 1995). In freshwater organic matter could exist in form of dissolved molecules, colloids or particles. It is very important in global biogeochemical cycles of C, N and P (Carlson, 2002) and in oceanic carbon budgets

(Hartnett and Devol, 2003; Hedges, 1992). The concentration of DOM in river waters exceeds those of the dissolved trace elements and represents a major component of organic matter in river waters (Wells, 2002). It could originate from a range of sources, it could be formed in water due to the microbial degradation or it could come from soils and rocks by weathering, urban waste water, atmospheric inputs, human activities (Hudson et al., 2007). The majority of organic carbon in the oceans is in the form of dissolved organic carbon (DOC). DOC represents one of the largest active organic carbon reservoirs in the biosphere (Amon and Benner, 1996). Amount of DOC in the oceans could be compared with the amount of CO₂ carbon in the atmosphere (Mannino and Harvey, 2000). In the upper ocean and in the coastal zone concentrations of marine DOC are the highest. Characteristic concentration in surface waters of open ocean are 60 - 80 µM and in the coastal zone they could go up to 200 µM, and then rapidly decrease within a few kilometres of shore (Vlahos et al., 2002). The majority of DOM consists of humic substances and in a lesser extent of fulvic substances (Džombak et al., 1986). DOC consist of a non-humic fraction with a known molecular class of compounds, like carbohydrates, polysaccharides, lipids, amino acids, proteins and resins (Piccolo, 2001) and a humic fraction that is defined as a category of naturally occurring biogenic, heterogeneous organic substances of high molecular weight (MacCarthy et al., 1990). Humic substances could be separated according to solubility into three components: humic acid, fulvic acid and humin (McDonald et al., 2004). Variations in concentration of organic carbon in river waters reflect terrestrial ecosystem changes and their export into the ocean have effect on ocean carbon budget and cycling.

As estuaries are highly dynamic systems that are an obligate pathway for material between rivers and sea, biologically reactive fraction of the riverine organic matter could be almost entirely mineralized (Hopkins et al., 1997; Moran et al., 1999). In the estuaries DOC exhibits a linear distribution as a function of salinity, that suggests conservative mixing (Abril et al., 2002; Avery Jr. et al., 2003; Dai et al., 2012; Dixon et al., 2014). DOC from river water contains significant labile fraction that is highly variable (Moran et al., 1999). Conservative DOC behaviour could be attributed to presence of simultaneous sources and sinks, so net changes in bulk concentrations is small (Moran et al., 1999; Raymond and Bauer, 2000).

2.3. Coastal environments - Estuaries

Basically, a semi-enclosed coastal zone where freshwater from rivers mixes with seawater is called estuary. Estuaries were formed throughout the sea level rising and flooding of river valleys. They represent major biogeochemical interfaces where flux of materials, dissolved and particulate, are brought from the land to the sea. Over the deposition of river material, coarse grained sediments are deposited near the mouth and finely grained sediments are taken further away. Estuarine regions are dynamic both physically and chemically (Fig. 2.2).

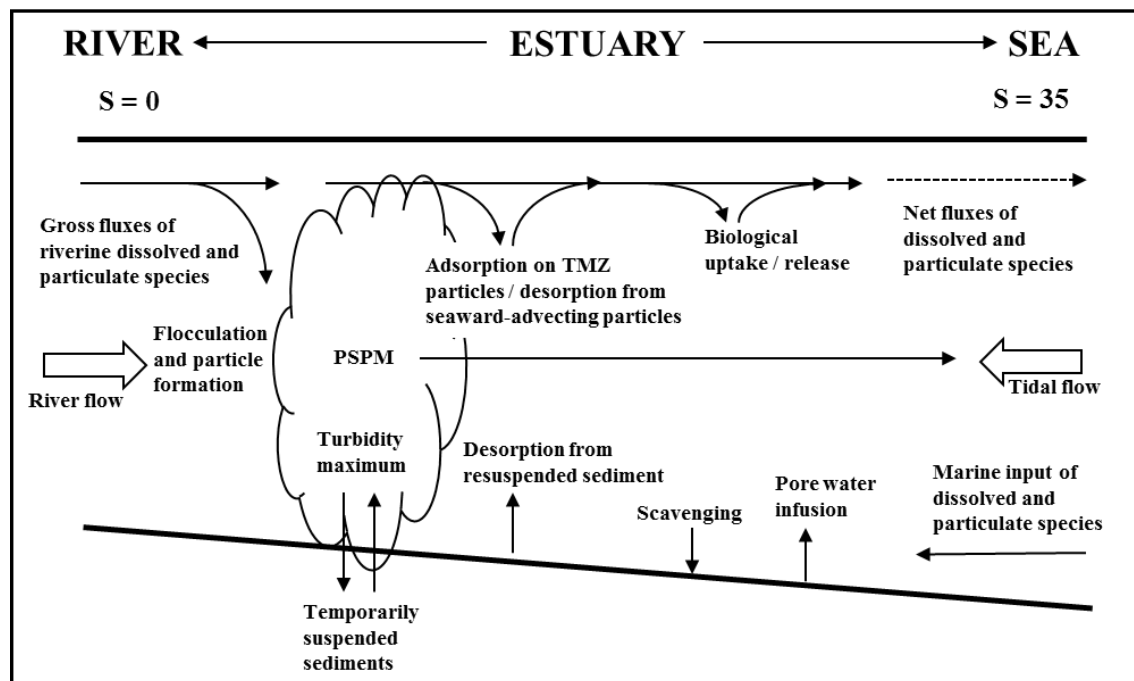

Figure 2.2. Schematic representation of major processes in the estuary

The result of fresh and seawater mixing is formation of a sharp gradient of different parameters like salinity, temperature, pH, dissolved oxygen and concentration. Different temporal and spatial variability in the estuary have a huge influence on physico-chemical conditions and processes. These processes are mostly biogeochemical like, sorption, flocculation or redox cycling of contaminants (Millward and Turner, 1995). Circulation and mixing controls the degree of vertical stratification. That depends on the proportions of riverine and tidal forcing. During estuarine mixing two non-biological and counteractive processes occur: desorption of metals from particles and the flocculation of metal-humates from solution. As seawater weights about 2.5% more than the same volume of freshwater, seawater is flowing in bottom layer in opposite direction from freshwater at the surface layer.

Despite strong density stratification these two types of water are often mixed. This mixing is dependent on the different hydrodynamic and morphologic characteristics of particular estuary.

2.3.1. Main types of estuaries

Estuaries could be classified according to different structures like topography, salinity, waves, tidal influence and etc. The main mechanism that is responsible for mixing is flow, but there are also other processes that have great influence like tide, wind or waves. Tide represents an important force that causes turbulence and mixing in the estuary. Wind is a powerful force only when the difference between high and low tide is small. It has great impact on the shallow estuaries, especially those with large open areas. Internal waves that affect mixing are generated under influence of wind. Due to the significant differences between the tides it is possible to have stronger mixing. By reduction of this tide differences, mixing becomes weak and stratification is formed.

According to different types of mixing, estuaries could be divided on:

- a) **Salt-wedge estuary.** Mixing on the border of freshwater and seawater causes intrusion of saltwater into the surface layer with an increase in direction of the sea. Minimal mixing of salt and fresh water forms a wedge that is the thickest part of the seaward, and decreases toward the mainland. Due to the minimal mixing of the water, a sharp change of salinity is formed along the vertical depth profile (e.g. Mississippi, Rio de la Plata, Ebro, Krka, Raša, Zrmanja, ...) (Fig. 2.3). Depending on the flow of the river shape of the wedge could be changed. These systems are highly stratified during high tide, when the seawater comes in the shape of a wedge, and during dry periods wedge shape may disappear. The water at the bottom is rich in nutrients that are there due to decomposition of plant and animal remains and causing a stimulation of biological production in the estuary. When organic and inorganic particles that are transferred by rivers come into contact with salt water they tend to flocculate and precipitate. After sinking from the upper layer, material is carried upstream by salt wedge. Decomposition of organic matter leads to the occurrence of even more nutrients within the estuary. Inorganic substances are deposited on the bottom, they enrich sediment and allow the growth of plants in the seawater. In areas where the circulation within the estuary is strong enough to remove deposited sediment, leaving a stony/rocky bottom, rooted plants are replaced by algae that can grow on these surfaces.

Phytoplankton floats freely in the water rich with a large amount of nutrients, especially near the river, grows quickly and provides food for zooplankton. As this community is carried downstream, dead organisms and animal faecal pellets sink to the bottom and enter in the "wedge" and they could be carried back to the river. Due to their decomposition water is richer in nutrients..

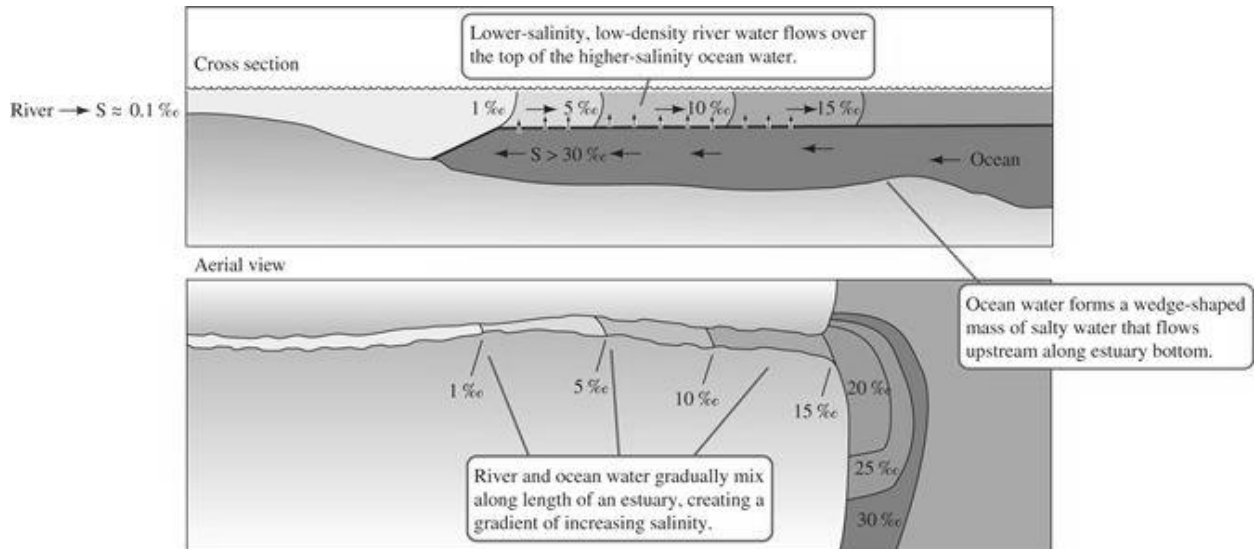

Figure 2.3. Schematic representation of the salt-wedge estuary.

- b) **Highly stratified estuary.** A highly stratified estuary occurs when a range between high and low tide is small. Their characteristic is dominant influence of river flow with a great interference due to the tidal currents (in large, turbulent rivers mixing of water column is stronger) and sharp halocline that separates water column on upper and lower layers. The salinity in the surface layer increases towards the sea, while the deep layer retains at the previous salinity. Stratification in these estuaries are similar to the salt wedge estuary, but remains strong during the tidal cycle, like those in other fjords and estuaries where the depth is > 20 m.
- c) **Partially mixed estuaries.** In shallow estuaries the volume of water that flows in and out of the estuary on the tidal cycles, creates strong currents in the saltier layer due to the volume of water in the "tidal prism" that is confined to a shallow layer. Partially mixed estuaries are nutrient traps. Nutrients are brought to the estuary by freshwater or sea water. From the fresher surface layer particles sink into the saltier layer and subsurface flow carries them. The deep salty current mixes then into the upper layer with mineralized plant nutrients. These estuaries are generally very productive.

- d) **Vertically homogeneous estuary (un-stratified).** Characteristic of un-stratified estuary is the dominant tidal currents as opposed to river flow (Fig. 2.4). Water is mixed well without major changes in salinity in the vertical water column. Gradual increase of salinity appears in direction from river to the sea.

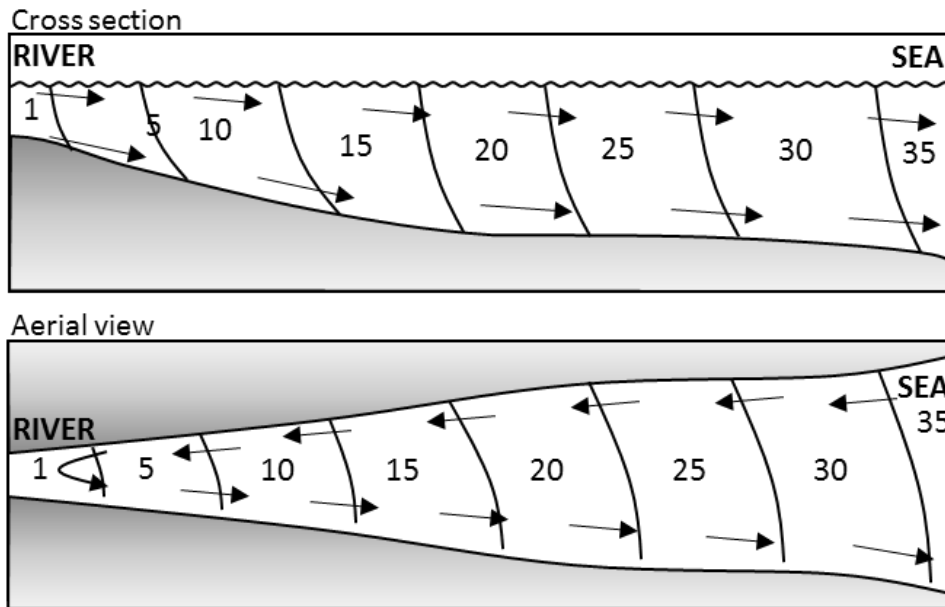

Figure 2.4. Schematic representation of vertically homogeneous estuary.

2.3.2. Processes in estuaries

Physical processes in estuary could be divided on those related to transport and those related to sedimentation.

a) *Hydrodynamics*

Several factors such as bathymetry, bottom roughness, wind, diffusion and boundary conditions (ex. tidal amplitudes) have an influence in determination of the contaminants transport in the estuary. Beside the mass transfer that is caused by the primary circulation, secondary currents could be created due to the tides.

b) *Topography*

In the estuary topographic features interacts with flow (a tributary junctions, bends, capes, deep holes and shallows) and lead to formation of secondary flows and waves. Internal waves are significant feature that appear due to the topography of estuary. They occur due to longitudinal flow over a shallow area and can lead to additional mixing. Topographical features in the estuary may have a significant role in enhancing the mixing or dispersion (Dyer, 1989).

c) *Salinity*

Salinity can inhibit vertical vortices due to the vertical gradient and may effect on sediment transport through increased flocculation. That is why the knowledge about salinity distribution is necessary. Middle layer is often called intermediate layer (the boundary between river and sea water) and it shows a trend that agrees with average river flow. Appearance of stratification and de-stratification in the estuary are very important processes for the contaminant transport and the flow of river water.

d) *Wind*

Wind is significant due to the changes that induce. It affects the sea level, currents and stratification, especially in shallow estuaries.

2.3.2.1 *Sedimentation processes*

Sediment in the estuary is formed from inorganic and organic particles that come to the estuary by river and sea water. "Salt wedge" that floats upstream along the bottom also brings sediment to the estuary. This may be the same sediment that the river has passed downstream and deposited on elsewhere in the estuary or suspended particulate matter originating from the ocean. Suspended sediment may occur in the estuary from the growth of phytoplankton and excretion from organisms or erosion of sediments. An important process in the estuary is the flotation process. Aggregates are formed from the particles under the influence of salinity changes that affects the rate of deposition on suspended solids. The amount of suspended particles in the estuary varies depending on the oscillation of tidal and seasonal factors. The combination of erosion and deposition affect the transformation of alluvial estuary and indicates the dynamic of the process. Variation in the flow rate can cause sediment re-suspension by increasing the concentration of particles suspended in the water column.

2.3.2.2 *Chemical processes*

Chemical processes such as the formation of precipitates, sorption in suspended sediment and degradation, determine the distribution of contaminants in the sediment, water column and atmosphere (Fig. 2.5). Salinity plays an important role in defining the structural and functional characteristics of wildlife in the estuary. Changes in the ionic strength of water are important for chemical processes in the salinity gradient. In seawater, the ionic strength is stable, however determination of macro constituents and total salinity are based on the concentration of one of the major constituents. When the river water and seawater are mixed

2. Literature overview

in the estuary, the question is what the ionic strength is and what is the lowest salinity at which Knudsen rule still stands. A change of the particles charge in water that occurs at a critical salinity of 5-8 is one of the most important physical phenomena in the salinity gradient (Telesh and Khlebovich, 2010). It results in different sedimentary formations on both sides of the critical salinity due to increased flocculation that affects the physical properties of water such as transparency (Khlebovich, 1990). The salinity gradient from 5 to 8 is formed in the nucleus of the estuary, and the chemical, physical and biological processes show no linear dynamic.

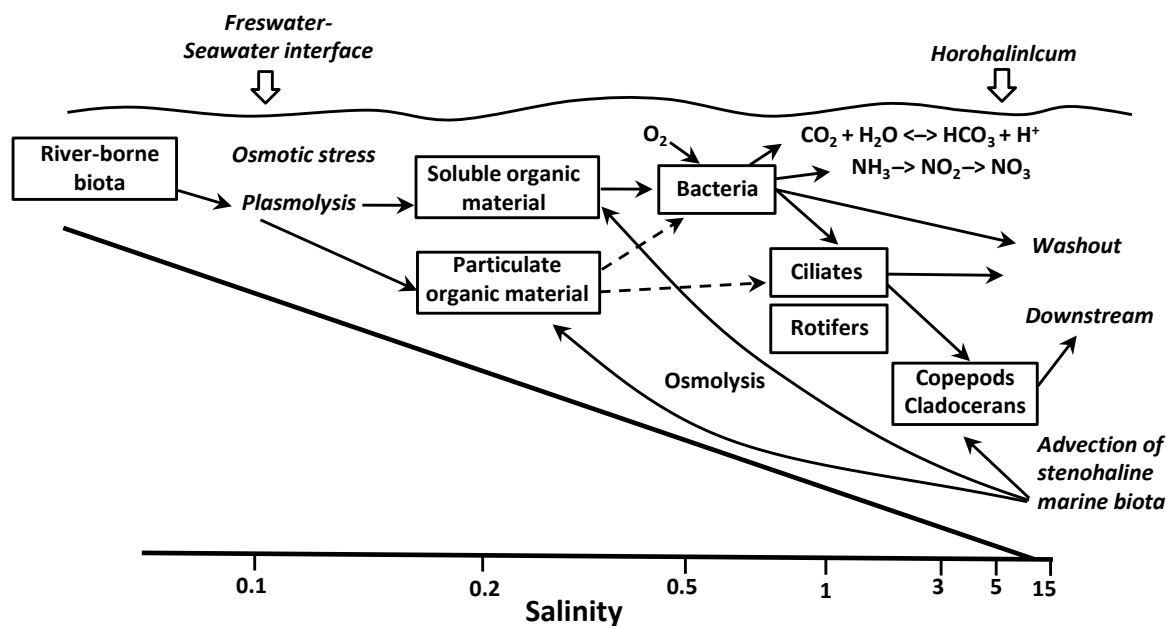

Figure 2.5. Biological and chemical processes that occur in the zone of low salinity in the estuary (McLusky and Elliot, 2004).

There is no linear relationship between chemical species in traces and salinity due to the different processes that affect their concentration during route through the estuary (Fig. 2.6).

Processes that affects dissolved substances:

- Photosynthesis* – leads to the formation of carbohydrates for feeding the cells and release oxygen
- Adsorption and desorption* – substances could be removed from the estuary by adsorption on the particles and desorption with the particles (Na⁺ replaces adsorbed Ca⁺)

- c) *Coagulation* - a charge of suspended particles could be neutralized by adsorption of ions that are present in water and allowed by Van den Waals forces. Deposition of bigger particles that are formed.
- d) *Deposition* - larger particles are deposited through the water column into the sediment by removing adsorbed species
- e) *Reactions in the sediment* - many substances are thermodynamically unstable (ex. organic material) or become like this in the sediment (e.g., metal oxides). New minerals may be formed (ex. pyrite). These reactions are the reason why the sediment pore water may have a different composition of estuarine water above the sediment. Concentration differences lead to exchange of substances between the sediment and estuarine water through diffusion or re-suspension.

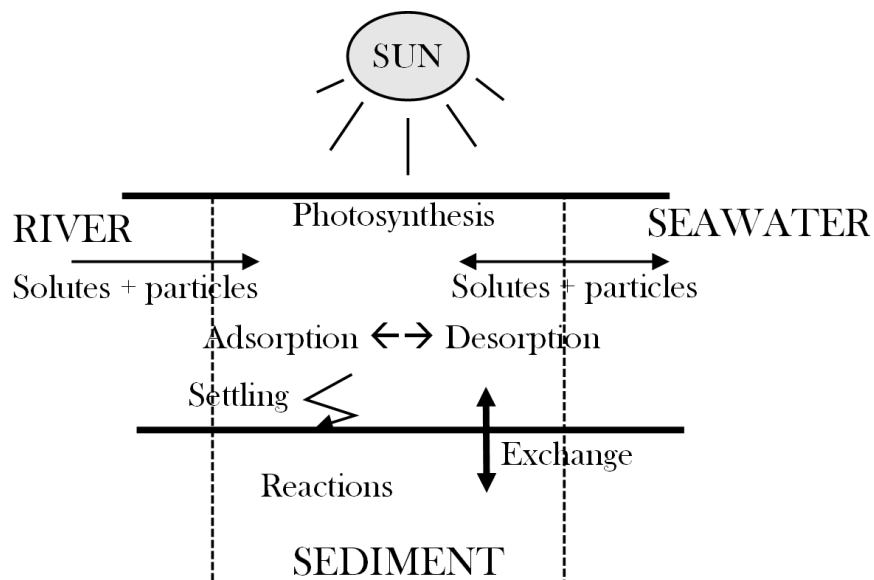

Figure 2.6. Processes in the estuary

The distribution of chemical species affects biological processes and biological productivity in the estuary. In many estuaries there is a significant anthropogenic influence of chemical species either directly or due to the river inflow. There are complex interactions between chemical, biological and physical processes in the estuary (Fig. 2.7). Since estuaries are time variable systems with characteristic topography, circulation and residence time behaviour of chemical constituents varies from estuary to estuary.

Mixing process in the estuary leads to continuous variations in salinity that corresponds to the important variables of physical and chemical reactions and ionic strength gradient. Concentrations in water depend on the geology of the environment and the various

2. Literature overview

processes. Major constituents in seawater have a concentration gradient in the same direction as salinity. Micro constituents are usually present in higher concentrations in rivers in comparison to the sea. The concentration of dissolved substances in the river varies, but is generally between 20-400 mg L⁻¹.

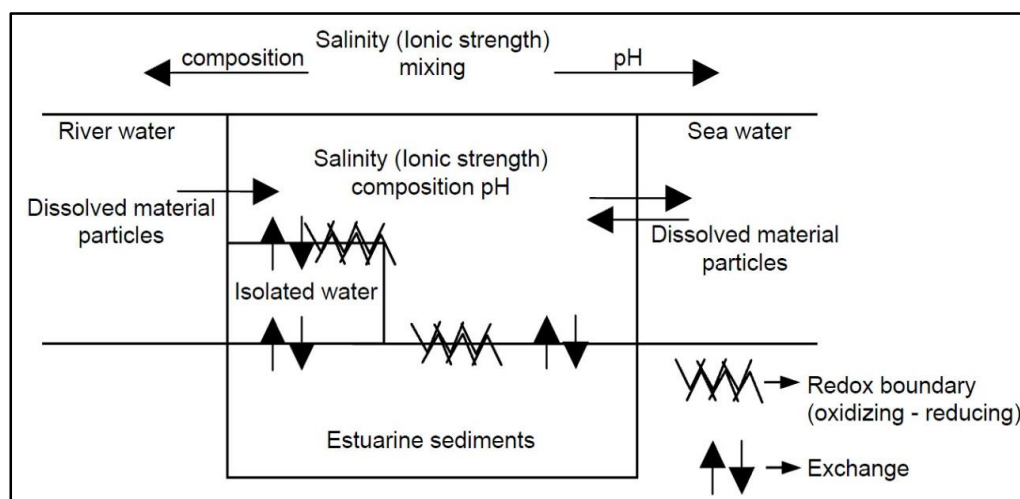

Figure 2.7. Chemical processes in the estuary.

The pH of coastal waters is usually around 7.8 or slightly higher. The pH of the river water varies from acidic water to water with high alkalinity. Extremes are possible but in the estuary pH is usually between 7.3 and 8.4. Changes of pH with mixing are nonlinear and additional changes could occur due to primary production and respiration.

Oxidation and reduction processes in water represent important physico-chemical variables. In the presence of free oxygen, at concentrations of saturation natural waters are oxidizing medium. The decomposition of organic matter that is mainly caused by bacteria is oxidation process. At low concentrations of oxygen, nitrate could be used as terminal electron acceptors. Some ions can be reduced in conditions of different redox potential that can occur in aqueous systems due to different amounts of oxygen present. After the exhaustion of nitrate, sulphates are used for the oxidation of organic matter. Due to the large amounts of organic matter in sediments of the estuaries, changes in redox conditions from oxidation to reduction are often immediately below the sediment and water border.

Most of the major elements are present in higher concentrations in seawater due to higher salinity. However metals like Fe, Al, Mn, Zn, Cu, Co, nutrients like P, N, Si and dissolved organic matter have usually higher concentration in freshwater.

2.3.3. Trace metals in estuaries

In the estuaries trace metals typically occur at concentration less than 1 ppb ($\mu\text{g L}^{-1}$). Although this concentration is low, their influence is important as micronutrients and due to their possible toxic effect. Metals fate and transport in the estuaries are controlled by a variety of factors, from redox, ionic strength, abundance of adsorbing surfaces, and pH (Turner and Millward, 2002; Wen et al., 1999). Highly dynamic nature in estuarine system is characterized by strong chemical and physical gradients. This makes trace metals cycling more complex in estuaries than in other aquatic systems (Millward and Turner, 1995; Morrel et al., 1991).

Interactions between particles and trace metals are important in controlling concentrations of trace metals in estuaries. Intense mixing and ionic strength gradients can significantly affect concentrations of dissolved and particulate metals in the water column through processes such as sorption/desorption, flocculation and different biological processes in the estuarine turbidity maximum (ETM). Processes in estuaries that could change physico-chemical forms or distribution of metals are association/dissociation, adsorption/desorption, precipitation/dissolution and aggregation/disaggregation (Cobelo-Garcia and Prego, 2004; Louis et al., 2009; Oursel et al., 2013; Waeles et al., 2009). They are strongly affected by the abundance of inorganic and organic colloidal material (Dai and Martin, 1995; Millward and Turner, 1995; Oursel et al., 2013; Santschi et al., 1997; Wen et al., 1999). In controlling adsorption/desorption of trace metals there are important binding sites on Fe and Mn oxyhydroxides, carbonates, clays and POC. Physical and chemical forces are critical in controlling the binding of trace metals to particle surfaces (Santschi et al., 1997). On larger scale internal processes and processes like storm events, tidal exchange, wind effects and input from rivers also contribute to the overall partitioning of metals in estuaries. Metal ion adsorption enhance at a higher pH and decrease at a lower pH. According to Santschi adsorption edges indicate that binding by cations are “metal like” and for anions “ligand like” (Santschi et al., 1997). On trace metal behaviour in estuaries great influences also have particle-particle interactions that involves metal oxides, clay minerals and colloids.

The reactivity of metals in estuaries could be interpreted by plotting metal concentrations along salinity gradient (Fig. 2.8). The simplest distribution pattern is a steady state with two end member. Metal with conservative behaviour is the one that shows linear trend with salinity.

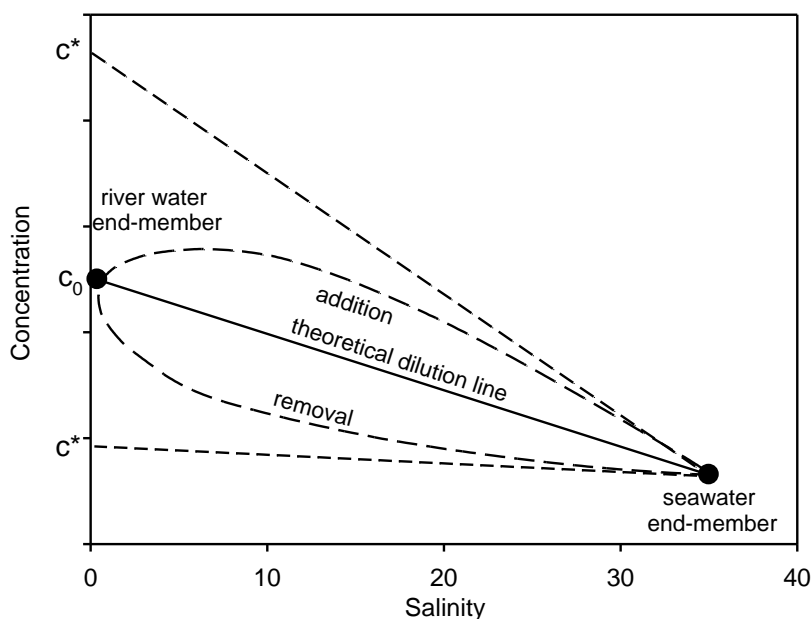

Figure 2.8. Illustration of steady state system with two end members (Wen et al., 1999).

In the case when metal is showing a non-conservative behaviour there is a net loss or some gain in the concentrations across a salinity gradient. Extrapolation from high salinities can yield an “effective” river concentrations (C^*). With that concentration metal reactivity could infer and their total flux could be determined. In the case when $C^*=C_0$ metals are behaving conservatively. Characteristic of non-conservative behaviour is removal of the metal ($C^*>C_0$) or addition within the estuary ($C^*<C_0$). This model with two end members is commonly used for estimation of river flux to the estuary.

Specific conditions are needed for application of conservative behaviour model. The river flow, stratification and seasonality are related to the high variability inherent in these factors together with their effect upon the metal concentrations in the end members (Michel et al., 2000). Salinity is representative variable of the mixing and dilution of the river end member concentrations into the marine water that is habitually more diluted (Elbaz-Poulichet et al., 1996; Nolting et al., 1999; Owens and Balls, 1997). Conservative behaviour was reported for Cu in many estuaries like Amazon estuary (Boyle et al., 1982), Dungun River estuary (Tahir et al., 2008), in Ob and Yenisey estuary (Dai and Martin, 1995) and in Rhone estuary, Wanquan Eiver estuary and Wenchang/Wenjiao River estuary (Fu et al., 2013). Pb showed conservative behaviour in Rhone (Dai et al., 1995; Elbaz-Poulichet et al., 1996) and in Yenisey estuary (Dai and Martin, 1995); Zn in Scheldt estuary (Zwolsman et al., 1997). Behaviour of Ni is mostly showing conservative behaviour according to literature (Dai et al., 1995; Fu et al., 2013; Hatje, 2003).

Different factors like the ion exchange, variation of ionic strength, adsorption and biological uptake could have influence on behaviour of trace metals in the mixing zone of an estuary so they start to behave as non-conservative. Cu could behave also in non-conservative way, that was recorded in San Francisco Bay estuary (Eaton, 1979), in Penze River estuary (Waeles et al., 2008), in South-eastern U.S. estuaries (Windom et al., 1983), in Vigo Ria (Santos-Echeanidia et al., 2008) and other estuaries (Koshikawa et al., 2007; Nolting et al., 1999; Owens and Balls, 1997). That behaviour could be associated to a slight increase of the strongest ligand which implies both variables co-vary during estuarine mixing as in Scheldt estuary (Nolting et al., 1999; Van den Berg et al., 1987). Cd was showing non conservative behaviour in different estuaries according to literature (Dabrin et al., 2009; Elbaz-Poulichet and Martin, 1987; Owens and Balls, 1997; Tahir et al., 2008; Tang et al., 2002; Waeles et al., 2009). Cd desorption could be expected in estuaries due to chloride and sulphate complexation and effects of ionic strength. In China Rivers Co and Pb has showed non conservative behaviour (Fu et al., 2013). Pb was found to behave on non-conservative manner (Monbet, 2006; Tahir et al., 2008) and results showed that estuary is acting as a sink for it. Co has showed non-conservative behaviour in Mississippi River delta (Shim et al., 2012).

Trace metals like Zn, Cu, Ni and Co are following spatial trends with percentage of organic matter in the water column. Most of the Fe in rivers may be in colloidal form, that is critical in the coagulation/aggregation removal processes of Fe in estuaries (Millward and Turner, 1995). Cd and Ni have a low affinity for colloidal matter (Dai et al., 1995). The limitation on particle-water interactions due to the low particle affinity of Ni and its strong affinity for DOM, Ni was found to be largely unreactive during mixing in Beaulieu estuary (UK) (Turner et al., 1998). It was associated with colloidal materials in river and it was converted into low molecular weight materials with increasing salinity in the Ochlocknee estuary (Powell et al., 1996).

Trace metals that are particle reactive (e.g. Pb) or have a nutrient-like behaviour (e.g. Cd) are typically removed from surface waters via adsorption in their vertical transport through the water column. Hydrous oxides of Fe and Mn are important in the sorptive removal of trace metals in estuaries (Perret et al., 2000; Turner et al., 2004). The distribution of these carrier-phase metals in estuaries, in lateral and vertical direction, is largely controlled by particle dynamics contrasting to other metals (e.g. Cu, Zn, Co) that are more affected by biotic uptake processes.

2.4. Speciation of trace metals in natural waters

The geochemistry and bioavailability of metals is controlled by their chemical speciation (the distribution over various chemical forms/species). To prevent the confusion problem about expressions, the International Union for Pure and Applied Chemistry (IUPAC) has defined following terms (Templeton et al., 2000):

- **Chemical species** - specific form of an element, defined as the isotopic composition, electronic and oxidation state and/or complex of molecular structure
- **Speciation analysis** - analytical activities of identifying and/or measuring the quantities of one or more individual chemical species in a sample
- **Speciation of an element; speciation** - distribution of an element amongst defined chemical species in the system.

When speciation is not applicable the term fractionation should be used:

- **Fractionation** – process of classification of an analyte or a group of analytes from a certain sample according to physical (e.g. solubility, size) or chemical (e. g. reactivity, bonding) properties

On the speciation and consequently on the mobility and bioavailability strong influence have natural and anthropogenic changes in environmental conditions. Natural systems are dynamic and changes in conditions (episodic changes) affect concentrations and speciation on a short term scale.

To specify the physico-chemical form of a particular element of interest the term speciation is used. Speciation could be defined in three ways (Fig. 2.9).

- First way is based on the physical attributes like size, density or electrical charge. Methods for measurement of these attributes usually are dialysis, filtration or electrophoresis. These methods are known as fractionation techniques. Fractionation may be dynamic like filtration or reflects equilibrium conditions like dialysis.
- Second way is based on complex liability and indirectly calculated size from mass transport phenomena such as voltammetry. This could be defining as kinetic speciation methods.
- Third way is based on free ion activity or concentration at equilibrium that is measured by ion selective electrodes or techniques of equilibrating a solution with ion exchange resin. These are equilibrium speciation techniques.

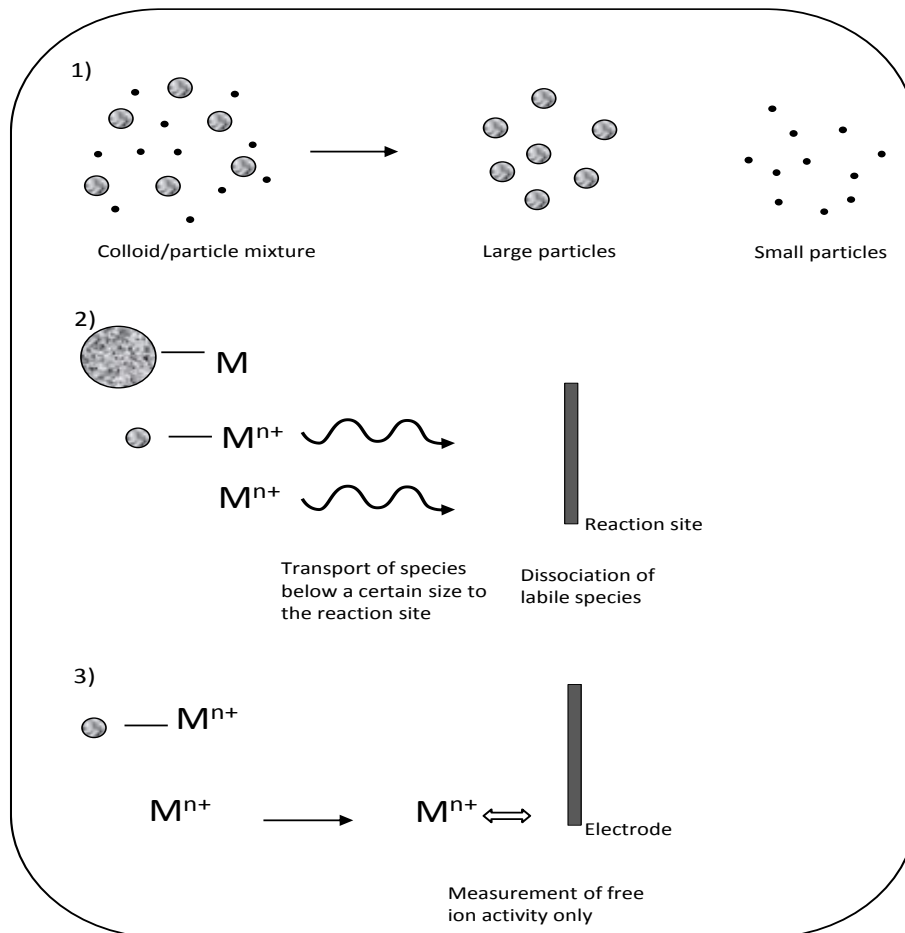

Figure 2.9. Schematic illustration of three type of speciation: 1) fractionation; 2) kinetic speciation; 3) equilibrium speciation (Lead et al., 1997).

Speciation of metal represents molecular form of metals under which they are transported in hydro systems. For instance trace metals are transported in surface waters in complexed forms. Organic or inorganic complexes represent association of an anion and a cation or neutral molecule. Measuring the concentration of an individual complex is rarely possible. Most of the techniques for measuring trace metal concentrations give the total concentrations regardless the speciation. Depending on the total concentration, pH, Eh conditions, the major element chemical composition of the water or complexation constants of the assumed complexes, it is possible to calculate the proportion of metals corresponding to the different chemical forms. For prediction of toxicity and bioavailability it is crucial to know concentration of the metal species. Specifically the toxicity of metals depends on their chemical form in waters more than on total concentration (Morrel and Hering, 1993). Complexation inhibit or enhance adsorption on surfaces. In river waters organic ligands are small organic weak bases like acetate or oxalate and low-molecular-weight humic acids that contains carboxylate or phenolate groups. Complexation constants of trace elements in

aqueous solution could be determined with different techniques (potentiometry, spectrophotometry, calorimetry, ion exchange, conductometry) (Nordstrom, 2003).

According to traditional definitions and methods, separations of differently sized metals in natural waters are based on a single split into “particulate” and “dissolved” fractions. This fractionation of trace metal in continental waters depends on the pore size of filters. Due to the presence of very small particles in solution that pass through filters they were operationally defined as a colloidal fraction (0.20 μm or 0.45 μm to 1 nm) and a truly dissolved fraction (< 1 nm) (Buffle and Van Leeuwen, 1992; Stumm, 1993). The dynamics of colloids has big influence on modelling of reactive solute transport due to dependence of toxicity on speciation, abundance and bioavailability of trace metals.

2.4.1 Complexes of trace metals in natural waters

The concentration of metal ions [M] can be presented as the sum of the concentrations of different physico-chemical forms of metal ions:

$$[M] = [M^{n+}] + \Sigma[MX] + \Sigma[ML] + \Sigma[M_{particles}]$$

[Mⁿ⁺] - concentration of free metal ions (hydrated ion)

Σ [MX] - sum of the concentrations of inorganic metal complexes

Σ [ML] - sum of the concentration of organic metal complexes

Σ [M_{particles}] - sum of the concentrations of chemical species related to particles

In natural waters different types of ligands that complex with metals are present and they could be divided into four basic groups:

- inorganic ligands - OH⁻, Cl⁻, CO₃²⁻, HCO₃⁻, SO₄²⁻
- organic ligands - including simple organic ligands (such as acetates, oxalates, amino acids) and macromolecules (humic substance)
- particle surface (external surface OH⁻ groups of Fe and Al)
- surface of organisms, different biological membranes

Simple scheme of interaction of metal ions (M) and ligand (L) shows the formation of a ML.

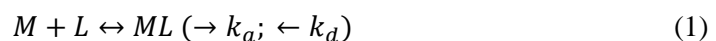

Where the association constant is marked with k_a , and dissociation constant with k_d . From the relationship k_a and k_d it is possible to obtain stability constant K .

$$K = \frac{[ML]}{[M][L]} = \frac{k_a}{k_d} \quad (2)$$

Depending on the association and dissociation rate of the metal ion complexes with inorganic and organic ligands they could be divided into two main groups: *labile* and *inert*.

Labile complexes are characterized by a dissociation rate constant. In voltammetry measurements they provide only one peak (peak or wave) independent of the number of ligands which are bound to the central ion. Due to the increased concentration of complexing ligand, for the unchanged concentration of dissolved metal, there is a difference of redox potential in relation to the redox potential of free metal ions. It is possible to calculate the stability constants of the complexes. In anodic voltammetry the lability of the complex depends on the time of its retention in the diffusion layer. This residence time is dependent on the thickness of the diffusion layer, and can be changed by changing the stirring rate of the solution.

Inert complexes are characterized by the dispute dissociation. Measurements provide two separate voltammetric signals. The signal on the positive potential corresponds to a reduction of free and labile complexed metal ions, and that on more negative potential comes from the reduction of inert complexes. As the complex is more inert - a potential of reduction is more negative.

2.4.2 Trace metals speciation in the estuary

In estuarine waters key processes is organic complexation of metals (Kozelka and Bruland, 1998; Louis et al., 2008; Shank et al., 2004; Tang et al., 2001, 2002; Van den Berg et al., 1987; Wells et al., 1998). Distribution and speciation of trace metals in estuaries depends on their concentrations and on the concentrations of dissolved complexing ligands and their associated coordination sites on colloids and particulates (Kozelka and Bruland, 1998). Across different estuarine systems number and role of important ligand classes that controls the complexation of different trace metals is highly variable across different estuarine systems. Zn and Cd are controlled by three ligand classes in Narragansett Bay (Kozelka and Bruland, 1998), Pb is controlled by two ligand classes in San Francisco Bay (Kozelka et al., 1997) and Narragansett Bay (Kozelka and Bruland, 1998) estuaries. For Cu concentrations of the stronger ligand class $[L_1]$ are equal or greater than total dissolved Cu $[Cu_D]$, this trend

is commonly found in other estuarine systems (Kozelka and Bruland, 1998). Experimental and field measurements have shown that production of $[L_1]$ by phytoplankton occurs in response to $[Cu^{2+}]$ concentrations (Bianchi, 2007). In case when $[L_1] > [Cu_D]$, CuL_1 is predominant specie. In estuary with anthropogenic metal input, $[Cu_D]$, could be greater than $[L_1]$, and weaker ligands $[L_2]$ and $[L_3]$ may be produced by bacterioplankton/phytoplankton to “buffer” complex the remaining Cu (Gordon et al., 2000; Kozelka and Bruland, 1998; Louis et al., 2009). Other studies have shown that the stronger binding ligands are produced by microorganisms, while the weaker-binding ligands have more humic character (Moffett et al., 1997; Vachet and Callaway, 2003). Some research has shown that typical range of Cu stability constants are $\log K'_1=11-14$ and $\log K'_2=8-10$ (Coale and Bruland, 1988; Donat and Van den Berg, 1992). In the case of the strong ligand class $[L_1]$, Pb and Cu speciation are controlled by dissolved and colloidal sized ligands in different regions of the bay. In all cases the weak ligand classes were found in the colloidal phase with stronger more stable ligands in the dissolved phase (Muller, 1999). Pb is a non-bioactive metal that is mostly bound in the colloidal sized complexes and essential bioactive metals Zn, Cd, Cu are mostly found in the dissolved complexes.

2.4.3 Bioavailability and effect of competition

The aim of determining the speciation is to learn more about bioavailability. Free ions of Cd, Pb, Cu and Al, are the most toxic forms of metals in aqueous systems, but their toxicity is reduced by complexation with natural ligands (Di Toro et al., 2001). It was found that Cd toxic effect towards green algae shows variations depending on the season in a eutrophic lake. To decrease toxicity of Cd (Mungkung et al., 2001) and Cu (Lorenzo et al., 2002) humic acid could be added.

Decrease of bioavailability of metal ions happens in the presence of humic ligands (HL) (Penttinen, 2010). Reduction of toxicity in hard water can be explained by competition of Cd and Ca. In the aqueous environment in term of concentration, cations responsible for water hardness (Ca and Mg ions), are significantly represented. They are competitive for the binding sites as compared to Zn and Cd ions. Although this competition is not fully explained, the available data suggest that it is one of the reasons for the decrease in their bioavailability (toxicity).

Different binding strengths exist due to the heterogeneity of natural organic substances (Džombak et al., 1986). By a discrete model they could be grouped on place of similar

characteristics for the complexation in seawater. Thus, there are binding sites that can be defined as potential ligands (denoted by L_1 with the lower concentration) and a weak ligand (denoted by L_2 , with the higher concentration). According to the current knowledge on dissolved organic ligands (Hirose, 1994), their concentration in the seawater is around 1-3 nM for a strong ligand (L_1), and 20-60 nM for a weak ligand (L_2). The concentration of free Cu^{2+} in seawater affects the reactivity of Cu that is directly linked to its relation to marine microorganisms (Sunda and Guillard, 1976). The concentration of free Cu^{2+} in the seawater is calculated as the total concentration of Cu on the basis of the equilibrium model (Hirose, 2007), that is taken into consideration and the effect of Ca and Mg.

The concentration of free Cu^{2+} is steadily growing in toxic concentrations of Cu (greater than 10 pM) (Sunda and Huntsman, 1995), wherein the concentration of total Cu exceeds that of strong organic ligands. The concentration of free Cu^{2+} is steadily growing when the Cu concentrations are toxic (greater than 10 pM) (Sunda and Huntsman, 1995), wherein the concentration of total Cu exceeds that of strong organic ligands. The concentration of free Cu^{2+} in the lower values (lower than 10 pM) is within the range of the total Cu concentration in seawater. With increasing of ligand concentrations, concentration of free Cu^{2+} ions is shifted towards lower values. These findings suggest that a weaker ligand has a greater influence than stronger ligand on decreasing of Cu toxicity in marine microorganisms. This agrees with the knowledge that a weaker ligand dominates in the speciation of Cu in coastal waters where Cu exists in higher concentrations (Donat et al., 1995).

Chemical model connected with the reactivity of organic ligands that are in the interaction with trace metals is moderated due to the Ca and Mg complexation. In seawater, the concentration of ligand is buffered by an excess of Ca and Mg. The concentration of free ligands is regulated, at low values, by the change of total concentration of ligands in solution.

2.5 Determination of trace metals concentration and speciation

A number of techniques are available to measure chemical speciation and fractionation of the metals in aquatic environments (Lead et al., 1997). These techniques have been developed for determining the physical and chemical form and type of trace metals in aquatic systems: electrochemical methods (voltammetry with the anode and cathode dissolution, potentiometry), spectroscopic methods, ion exchange, extraction, dialysis, ultrafiltration, chromatography and computer modelling (Florence, 1986). It is not possible to determine

all physic-chemical types of trace metals due to the method specificity. Each method is characterized by the so called “detection window”, which means that a particular method determines only a part of the distribution of trace metals.

For trace metal speciation it is important to use robust methods as toxicity and mobility of trace metals are connected to the metals speciation (Stumm and Morgan, 1996). The first step in determining speciation of trace metals is to define a certain group of complexes that needed to be determined. Usually they could be separated by physical shapes and by chemical species. Physical shapes represent trace metals connected to a variety of solid surfaces (colloids, particular particles, different organisms, etc.). Chemical species include various metal complexes with inorganic and organic ligands that are dissolved in solution. Following requirements should be guided for selection of the method for determination of the metal chemical species (Nürnberg, 1977):

- In initial composition of the sample make the least possible changes
- Between sampling and analysis delay should be minimal
- It should have possibility for determination of the natural metal concentrations (nM, pM)
- It should be selective for certain forms
- It is preferably to quickly determine at the same time more metals
- Low cost due to the need of a large number of determination

2.5.1. Voltammetric techniques for trace metal speciation determination

Voltammetry techniques have provided a powerful tool for measuring the speciation of trace metals at low concentrations. Most of the bioactive trace metals are now analysed with this technique. Different forms are involved in different biological and geochemical interactions and hence the cycling of trace metals within the ocean. Studies of trace-metal speciation have impact on ideas of the role of trace metals in biological systems.

Voltammetry procedures like anodic stripping voltammetry have been used extensively for determination of metal concentration and for making speciation measurements in natural waters (Buffle, 1988). It is possible to measure both, free metal ions and complex species of trace metals. To measure metals in the complex, the complex must be labile and mobile. If dissociation occurs in the time needed for the complex to diffuse through the diffusive boundary layer that surrounds the electrode, criteria for lability is satisfied. Time needed for dissociation is typically 0.1 seconds. Mobility is determined by movement through the

boundary layer by diffusion. It is related to the diffusion coefficient and consequently to the size of the complex. For standard laboratory electrodes, where current response to the analyte is proportional to the square root of the diffusion coefficient, the size cut off, above which particles are effectively not measured, has been calculated to be about 50 nm (Buffle, 1988).

With electrochemical methods like sensitive anodic stripping voltammetry in differential pulse (DP) mode it is possible to study Zn (Bruland, 1989), Cd (Bruland, 1992), Pb (Capodaglio et al., 1990) and Cu (Coale and Bruland, 1990). Broader group of trace metals could be determined with another voltammetry technique, adsorptive cathodic stripping voltammetry (AdCSV). The application of AdCSV for speciation studies includes the addition of known ligand (AL) that creates a competitive equilibrium with the natural ligands for the metal of interest (Van den Berg, 1988). Neutral bis-complex could be formed with the AL in most of the methods (Bruland et al., 2000).

Complexation of trace metals with strong metal binding organic ligands is important in surface waters of sea. For instance in surface waters great percentage of metals are complexed with organic ligands: around 98% of dissolved Zn in surface waters (Ellwood and Van den Berg, 2000; Lohan et al., 2002), approximately 80% of Cd (Bruland, 1992), more than 99% of Cu exists as organic complexes (Coale and Bruland, 1988; Moffett et al., 1990). Chemical structure of organic ligands that are involved in binding with metals in sea water is not very well known.

2.5.1.1 Anodic stripping voltammetry (ASV)

Anodic stripping voltammetry is a technique that is used to directly measure the kinetically labile complexes (inorganic and weak organic) and free metal ions (M^{n+}). Sample is titrated with the metal of interest and at each titration point it is possible to determine concentrations of the metal-binding ligands and conditional stability constants (binding strengths) for metal-ligand complexes. Metals that could be determined by ASV are those that are soluble in liquid Hg (forming amalgams), that can be reduced and reoxidized at the suitable potentials and metals that are chelated with strong organic ligands so they are kinetically inert.

This method is a two-step technique that involves a pre-concentration step and a stripping step. In the pre-concentration step a controlled potential is applied to the working electrode, at a potential more negative than the half wave potential of the metal ion while the working

electrode behaves as a cathode. Duration of this step could be between 5 to 10 minutes. During that time M' is continually reduced and concentrated into Hg amalgam. The reduction reaction is allowed to take place over a fixed time period and under identical conditions. For the stripping step, the potential applied to the electrode is reversed, i.e. to potentials more positive than the half-wave potential of the metal ion, the working electrode behaves as an anode. As the applied potential reaches the half wave potential of the metal ion, oxidation of the amalgam occurs and the metal ion is stripped from the amalgam back into the solution. The peak currents are produced as the system reaches the oxidation potentials, that are characteristic for each electrochemical species that is measured. The deposited analyte is determined by voltammetric procedure and resulting voltammogram provides the analytical information of interest.

Some limitations exist in ASV, such as the requirement that the element is reduced to the elemental state and that is soluble in mercury. Four metals (Cd, Pb, Cu and Zn) can successfully be determined by ASV.

Problems considering metal determination by ASV could be due to too low concentration or there could be interference such as those due to the formation of insoluble intermetallic compounds in Hg. When intermetallic compounds are present, the stripping peaks may be shifted, severely depressed or absent completely (Willard et al., 1988). The main advantage in this technique is in the preconcentration step prior to the voltammetric scan.

2.5.1.2 Adsorptive Cathodic stripping voltammetry (AdCSV)

Adsorptive cathodic stripping voltammetry is a very sensitive technique for the analysis of numerous trace metals which cannot be determined in water using conventional electrolytic stripping procedures. The mechanism involves the formation a surface active complexes of the target metal (in presence of a suitable complexing ligand that is added to a water sample and forms an adsorptive complex with the trace metal) and interfacial accumulation of complex onto the working-electrode. In the most cases, chosen adsorption potential is slightly more positive than the reduction potential of the metal-ligand complex. Deposited material could be determined by linear-scan or pulsed voltammetric measurements. The scan direction is towards more negative potentials and the resulting current is measured. The current produced is the result of the reduction of adsorbed metal complex.

Adsorption process could be described (Wang, 1989):

- The metal M^{n+} reacts with a ligand L to form the complex in solution



- Then complex is adsorbed onto the electrode surface



- Following complexation reactions ligand L is adsorbed first

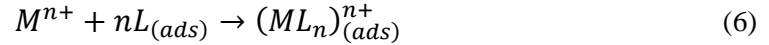

- Surface-active complex with ligand could be formed not just with metals and cations, but also with oxidized or reduced electrochemical form of the metal cation

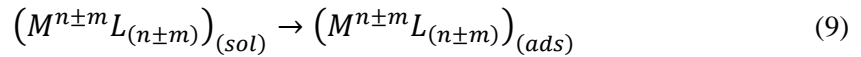
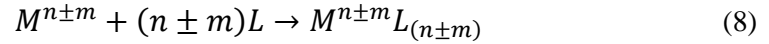
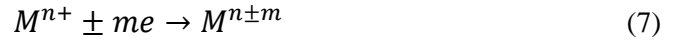

Adsorptive stripping voltammetry has been applied to the determination of a variety of inorganic cations at very low concentrations. The cations complex with surface-active complexing agents (ligands) and detection limits are in range 10^{-10} to 10^{-11} M (Skoog et al., 1996). Ni and Co were determined by method of adsorptive cathodic stripping voltammetry with addition of Nioxime as ligand and boric puffer to control pH as the formation of the metal-ligand complex is pH dependent. Contrasted to ASV this method does not require the metal solubility in Hg, so it could be used for a different trace metals. For speciation studies AdCSV method could be as well used (i.e. Zn (Ellwood and Van den Berg, 2000; Lohan et al., 2002), Cu (Donat and Van den Berg, 1992), Co (Ellwood and Van den Berg, 2001; Saito and Moffett, 2001), Fe (Bruland et al., 2001).

2.5.2. Diffusive gradient in thin films (DGT) technique

Technique of diffusive gradient in thin films (DGT) was created in 1994 by Davison and Zhang for in situ measurements of labile trace metal species in aquatic environments (Davison and Zhang, 1994). This technique allows diffusion of chemical species through a diffusive gel with known diffusion coefficients for the species. DGT devices could be used in water (Zhang and Davison, 1995), in sediments (Winderlund and Davison, 2007; Zhang

and Davison, 1995) and in soils (Zhang et al., 2001). Main advantage of DGT technique is minimization of variations in speciation for the period of sampling and storage (Lead et al., 1997). In addition with this technique it is possible to measure more metals at the same time, for deployment and retrieval it needs shorter effective time and it is relatively inexpensive. Plastic sampling device with an opening, contains a membrane filter, diffusive layer and binding layer (Fig. 2.10) (Zhang and Davison, 1995).

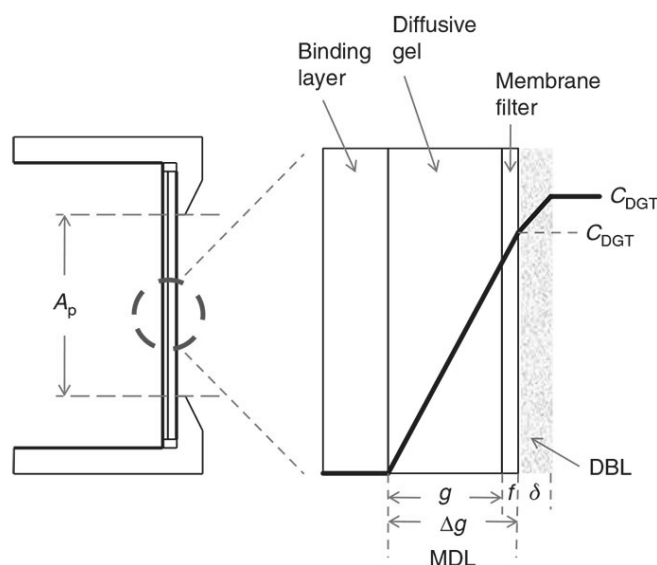

Figure 2.10. Illustration of DGT piston assembly and an expanded view of the binding and diffusion layers (Davison and Zhang, 2012).

To determine the diffusible components of water this technique involves the use of hydrogels in the presence of ion exchange resin. The “diffusible” species diffuse through the diffusive layer and accumulate in the binding layer where metals bind with resin. The diffusive layer has a well-defined thickness and normally consists of a polyacrylamide diffusive hydrogel and a protective membrane filter. The binding layer is made from Chelex-100 cation exchange resin embedded in polyacrylamide gel. In the diffusion layer concentration gradient is developed. Concentration is there equal to the bulk concentration on interface water/filter membrane and it is effectively zero at the binding layer surface (Fig. 2.10). Until the saturation of binding layer the concentration gradient is maintained. The use of a gel layer in front of the resin provides a well-defined diffusive boundary layer that constrains mass transport and given fully quantitative data (Davison and Zhang, 1994). Process of accumulation continues during the deployment time. To calculate the average concentration of metals during the exposure time it is needed to know time of deployment, temperature of media, accumulated mass and diffusion coefficient of the analyte.

2.5.2.1. Factors affecting DGT performance

On accuracy of DGT measurements several factor could have influence: DGT blank variability, elution factor, diffusive coefficient, diffusive boundary layer, temperature variations during deployment, and variations in thickness of the diffusive gel.

Effective sampling area. According to measurement with ICP-MS the effective adsorption area on the binding layer from simple, non-complexing, inorganic solutions were systematically higher then concentrations measured directly in solutions. With this error overestimation of concentration could be ~20% more than the area of the DGT device window (Warnken et al., 2006). This was related with difference between geometric surface area of DGT (3.14 cm²) and effective surface area (3.80 cm²) (Fig 2.11). The main reason for this difference is a fact that the diffusion pathway into the membrane is not vertical then also lateral on the filter paper, there is extra material supplied at the edges in curved diffusion paths (Davison and Zhang, 2012). So the systematic error was suggested to originate from this fact.

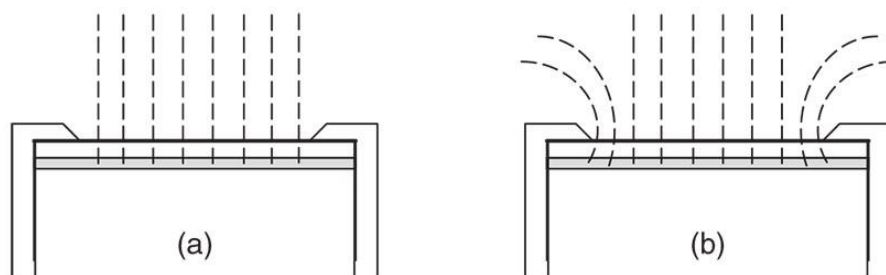

Figure 2.11. Sketch of diffusion pathways on the DGT device without convection in solution. (a) for physical geometric area. (b) effective surface area (Davison and Zhang, 2012)

Binding layer. DGT with Chelex 100 as resin gel could be used for measurement of 24 elements: Zn, Cd, Pb, Cu, Co, Ni, Al, Mn, Ga, La, Ce, Pr, Nd, Sm, Eu, Gd, Tb, Dy, Ho, Er, Tm, Tb, Lu and Y (Garmo et al., 2003). In natural waters, major cations are present at high concentrations with very low affinity to Chelex resin. Due to the modification of the binding layer it is possible to apply DGT for measurements of other metals. For instance with exchange of Chelex resin with an iron oxyhydroxide it is possible to measure anionic phosphate (Zhang et al., 1998) and inorganic As (Panther et al., 2008), Se in soil (Sogn et al., 2008) and P, As, V, W, Mo, Sb, U in the sediments (Stockdale et al., 2008, 2010). TEVA

and Dowex 1x8 anion exchange resin could be used for determination of Tc (French et al., 2005) and U (Li et al., 2007). Concentration of labile Hg (Dočekalová and Diviš, 2005) and methyl Hg (Clarisse and Hintelmann, 2006) could be measured by Thiol resin.

Diffusive boundary layer (DBL). At the interface between the protective membrane filter and surrounding water, a thin layer is developing. Transport of elemental species in that layer is changing from advection and diffusion processes in the sample solution, to diffusion in the diffusive gel. This layer is called diffusive boundary layer (DBL). This layer works as an extension of the diffusion layer (Fig. 2.10). Initially thickness of the DBL was assumed to be negligible in well mixed solutions and natural waters (Davison and Zhang, 1994) however it was soon shown to be significant in stirred solutions at low stirring speeds (Zhang and Davison, 1995). DBL depends of water flow; it is larger when the flowing is low. In high flowing waters thickness, δ , of DBL was estimated on 0.23 mm (Warnken et al., 2006), that is approximately 25% of the DGT diffusive layer thickness, Δg .

With neglecting the DBL the error is less than 10 % for standard thickness of the gel. In laboratory conditions DGT devices could be immersed in solution with well-defined vortex by using a magnetic stirrer, DBL is then around ~ 0.2 mm. If the complexes in solution are fully labile the contribution of free and complexed metal to the total metal accumulated will be governed by the rate of diffusion of each species (Scally et al., 2003).

According to new founding the term material diffusion layer (MDL) is now in use. It takes in account thickness of diffusive layer and membrane filter (Fig. 2.10) (Levy et al., 2012; Warnken et al., 2006; Webb and Keough, 2002).

Bio-fouling. In natural waters biofilm could be formed at the surface of DGT as a consequence of the exposure. Various elements like extracellular polymers from cell metabolism, algae, bacteria and fungi that creates biofilm, interacts with trace metals through different processes in water (van Hullebusch et al., 2003). Problem with appearance of biofilm on the DGT membrane surface is its influence on the thickness of DBL and possible modification of diffusion coefficient (Pitchette et al., 2007; Uher et al., 2012). Biofilm effect could be avoid by deployment time less than 7 days in conditions that are suitable for biofilm growth (Uher et al., 2012).

Temperature. Temperature is important factor in determination of proper diffusion coefficient. So it is needed to be measured during deployment. Temperature data loggers are usually deployed on the same depth as DGT. Diffusion coefficients are determined for temperature range 5-35°C (Zhang and Davison, 1995).

pH. Organic complexation in natural waters is mostly controlled by pH due to increase of organic acids dissociation with increasing pH, and making more COO^- and OH^- groups for trace metal complexation (Eby, 2004). DGT measurements could be made in wide pH range. Limitations are connected only with the characteristics of the binding agents and diffusion coefficients. For instance lowest pH for determination of Cd is between 4-5 (Gimpel et al., 2001; Zhang and Davison, 1995) and Cu in synthetic solutions could be measured up to pH 2 (Gimpel et al., 2001).

Ionic strength. Research of the DGT properties has showed that DGT could be used in waters with low ionic strength (I), down to 10 nM (Zhang and Davison, 1995). Further researches have shown that for $I < 1$ mM precision and accuracy are lower (Sangi et al., 2002; Warnken et al., 2005). During the production of DGT it is important to wash diffusive gels to decrease product of polymerization that were not reacted (Warnken et al., 2005). According to some research it was concluded that DGT could be used down to $I = 0.1$ mM with good precision (Scally et al., 2006; Warnken et al., 2005).

Capacity of accumulation. Based on the capacity of the adsorbent, in binding layer, maximum of accumulation is limited. For DGT with Chelex-100 resin maximum capacity for DGT is approximately 6 μmol (Zhang and Davison, 1995). In the oceans due to the low metal concentrations, maximum accumulation corresponds to 2.5 years, with saturation as only limiting factor. In coastal water and unpolluted fresh water the concentrations of metals are usually higher (around 10 times) so maximum deployment time could be 10 times shorter, it is around 3 months. Due to the high accumulation deployment time is not often limiting factor.

2.5.2.2. *Diffusion coefficients of trace metals in hydrogel*

To interpret DGT measurements quantitatively, in terms of the species present in solution, it is important to know the diffusion coefficient of each species within the gel. Diffusion

coefficients that were provide with DGT instructions were determined by DGT Research Ltd. in the laboratory at different temperatures according to equation:

$$\log D = \frac{1.37023(T-25)+8.36*10^{-4}(T-25)^2}{109+T} + \log \frac{D_{25}(273+T)}{298} \quad (10)$$

D and D_{25} are the diffusion coefficients of the deployment temperature and at 25°C.

However these values only apply to free ions (the true dissolved species). DGT hydrogel consists of ~10% cross-linked polymer that limits permeability of the gel. This lowers effective diffusion coefficients as the gel becomes tighter. On the rate of diffusion great influence has ionic strength, composition of solution and pH. In natural waters metals could be bound to larger molecules to a large extent like fulvic acid. According to Scally et al. (2006) diffusion of complex of fulvic acid and metal ions are slower due to higher molecular weight and larger size in comparison to non complexed metal ions. That is why coefficients for non-complexed species leads to errors in calculation of concentrations.

On the other hand in natural water it is not easy to know all species so operational value, called *DGT labile* is in use. Diffusion coefficients could be determined by use of two independent methods: by diffusion cell (Chang et al., 1998; Osterlund et al., 2010; Zhang and Davison, 1999) and by direct uptake to DGT device in solution with known concentrations.

Determination by diffusion cell. The diffusion cell consists of two compartments that are separated by a rubber spacer and clamped together (Fig. 2.12). Compartments are connected through a hole (diameter 15 mm) in which disc of diffusion gels (diameter - 2.5 cm and thickness of 0.82 mm) and protective membrane filter (thickness 0.14 mm) are mounted. The filter is exposed to compartment A. During the equilibration period both compartments should be filled with 0.01 M NaNO₃ solution. In the compartment A solution should be spiked with standard solution of metals and on that way it will contain the diffusing ions of interest. In the compartment B Mili-Q water and 0.1 M NaOH should be added to compensate pH and change of volume. Stirrer mixes both compartments continuously and thermometer in compartment A register the temperature. Samples should be taken on defined time during the experiment form compartment B or from both compartments.

From measured concentrations the mass of analyte that diffuse to compartment B could be calculated. Diffusion coefficients, D_{DC} , could be determined from the slope of the graph “diffuse mass vs. time” (Zhang and Davison, 1999):

$$D_{DC} = \frac{\text{slope} \cdot \Delta g}{C \cdot A} \quad (11)$$

Δg – thickness of the gel and filter

C – concentration in the compartment A

A – exposed area of the diffusive gel

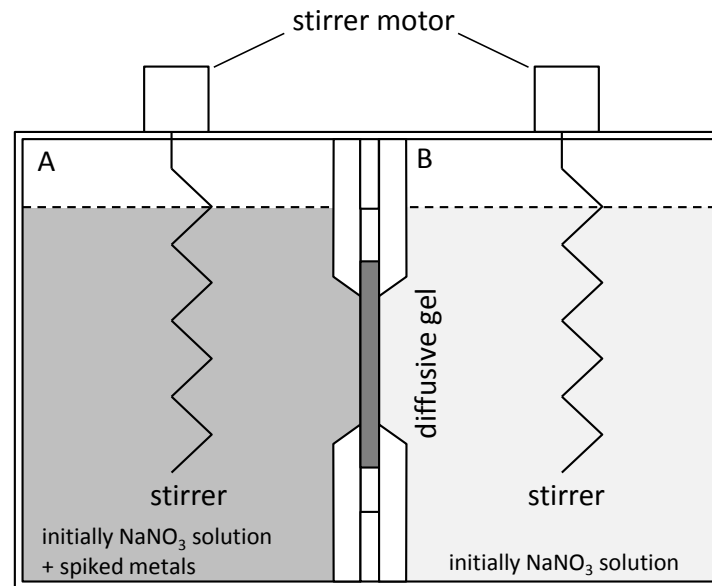

Figure 2.12. Diffusion cell for determination of diffusion coefficients.

Determination by direct uptake. Experiment set up requires three bottles of at least 2L, magnetic stirrer and NaNO_3 for preparation of solution and NaOH or HNO_3 for pH adjustment. Osterlund et al. (2010) prepared 5 L solution of $10 \mu\text{g L}^{-1}$ of each analyte in 0.01 M NaNO_3 . In each bottle 1.5 L of solution was added and pH was adjusted with 1 M NaOH or 1.6 M HNO_3 to 4, 6 or 8. After two days of equilibration, 1.25 L of each solution was transferred in new bottles with attached DGT devices in duplicate and temperature logger. Stirring was adjusted to be similar in all three bottles. Experiment was hold for 24 hours. Effective diffusion coefficients (D_{eff}) were calculated from equation:

$$D_{\text{eff}} = \frac{M \cdot \Delta g}{C \cdot A \cdot t} \quad (12)$$

M – accumulated and eluted mass of analyte; t – time.

2.5.2.3. Determination of trace metal concentration by DGT

After defined deployment time t , binding gel should be retrieved and analysed. Analyte is desorbed/eluted from the binding layer and determined with a suitable analytical technique. Fick's first law of diffusion describes the flux, J , through the diffusive layer:

$$J = D \frac{dC}{dx} \quad (13)$$

D - diffusion coefficient

C - concentration

x - distance

$\frac{dC}{dx}$ - concentration gradient

Mass of accumulated metal, M , could be measured after eluting it from Chelex with acid and it is related to the concentration of metal in the solution, C , and the diffusive coefficient of the metal through the gel, D . Accumulated mass could be calculated with the following equation:

$$M = \frac{C \cdot D \cdot A \cdot t}{\Delta g} \quad (14)$$

Δg - thickness of the diffusion layer

t - deployment time

A - area of the exposed gel.

With calculated M it is possible to calculate the flux through diffusion layer through known open window, A , during deployment time:

$$J = \frac{M}{A \cdot t} \quad (15)$$

According to this different effective surface area, equation for calculation C_{DGT} is:

$$C_{DGT} = \frac{M_{DGT}(D^w \Delta g + D^{wMDL} \delta)}{t D^w D^{MDL} A_e} \quad (16)$$

2.5.2.4. Speciation of trace metals by DGT

Speciation is possible to determine by using DGT with a different pore sizes of diffusive gel, in parallel. It is possible to distinguish labile complexes based on size – small (possibly inorganic complexes) and large (labile organic complexes). Accumulation in the binding layer is based on size of the pore and lability of complexes. Open pore (OP) DGT have

diffusive gel pore diameter around 5 nm so hydrated cations (Zhang and Davison, 1995) and small complexes (Scally et al., 2003) can move freely.

Speciation could be explained by equilibrium reaction of metal ions M, ligands L and the complex ML:



Metal ions are continually removed by adsorption to the binding layer, so the equilibrium in diffusive layer is disturbed so dissociation of the complex is promote.

For labile complexes (Fig. 2.13A), there is fast reaction between metal ions and complex with resin, so concentration on the surface of the resin decrease to virtual 0. As complex dissociates, all metal ions that are associated with the complex are adsorbed to the binding layer. Inert complex on (Fig. 2.13A) does not dissociate, so analytes from this complex could not be measured. It is only possible to measure metal ions. When labile complexes are partially labile (Fig. 2.13A) there is decrease of complex concentration near the binding surface, but removal is not complete. Concentration gradient occurs with constant diffusion flux, metal contents increases with time (Tusseau-Vuillemin et al., 2004).

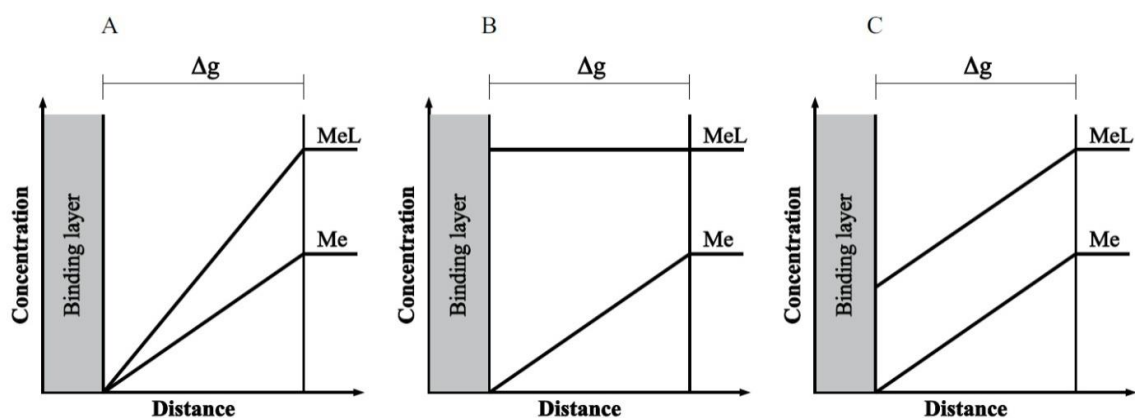

Figure 2.13. Schematic presentation of the concentration gradient in diffusion layer illustrating A) labile complexes, B) inert complexes, C) partially labile complexes.

Dissociation is slow and kinetics control accumulation so concentration is dependent on the thickness of the diffusion layer (thicker diffusion layer need longer dissociation time). Organic ligands that are present in natural waters are often smaller than 5 nm in size (Dahlqvist et al., 2007; Lyvén et al., 2003). Depending on lability, complex of analyte with organic ligands contributes to the accumulated mass in DGT. These complexes have lower diffusion coefficients than “free” ions, consequently it is possible to underestimate the DGT concentration when diffusion coefficients for free metals are used. This is why DGT with

restrictive pore (RP) were developed (Zhang and Davison, 1999). With pore size of ~ 1 nm their goal is to retard larger complexes to a higher extent than the OP DGT. In comparison OP and RP DGT it could be concluded that diffusion of “free” ions and complexes is slower in RP DGT (Sccally et al., 2006).

For a known diffusion coefficients for ligands in the sample it is possible to estimate speciation of inorganic and organic labile metal concentrations (Zhang and Davison, 2000). DGT with different pore size were used for measurement of diffusion coefficients for some natural and synthetic organic ligands (Sccally et al., 2006; Zhang and Davison, 1999). Mass of analyte accumulated in the DGT is sum of organic (M_{ML}) and inorganic (M_{MX}) species:

$$M_{DGT} = M_{ML} + M_{MX} \quad (17)$$

$$M_{DGT} = \frac{(C_{ML}D_{ML} + C_{MX}D_{MX}) \cdot t \cdot A}{\Delta g} \quad (18)$$

Experiments have shown that a substantial part of organic complexed metals could pass through diffusive gels with restrictive pores. Two types of DGT were used (OP and RP) in a river affected by acid mine drainage (Balistreri et al., 2007). Calculations with biotic ligand model have predicted high degree of complexation of Cd and Cu, with the same concentrations from OP and RP DGT. This could be partly explained by experiment conducted with van der Veecken (van der Veecken et al., 2008) in which evidences was found that implying that gel pore sizes are larger than it was estimated. In solution with latex particles complexed with Pb, concentrations after equilibration were 30-50% in the OP gel and 65% in RP gel.

2.5.2.5. Practical problems associated to DGT measurements

There is possibility of leakage that occur in the DGT casting from the seal between the piston and the cap. Testing was performed by Wagner within his BSc thesis (Wagner, 2004). Series of simple experiments were performed, using DGT probes loaded with tissue paper in place of the gel assembly. DGT prepared on that way are called “pseudo DGT”. They were placed during 8 hours in coloured dye solution. Depth was determined to submerge the seal between the base of the piston and the bottom of the cap, so does the top of the device stay above solution surface (Fig 2.14). After 8 hours it was visible that the dye solution was able to enter in the DGT through the seal between the base of the piston and the bottom of the cap (Fig 2.15). To determine effect of DGT leakage, they were immersed in solution (20 mM ionic

strength) spiked with $100 \mu\text{g L}^{-1}$ of Cu, Cd, Zn, Pb and U. During retrieval processes 5 mm annular ring was separated from 19 mm diameter internal disc and they were eluted and analysed separately.



Figure 2.14. Pseudo DGT deployed in dye solution (Wagner, 2004).

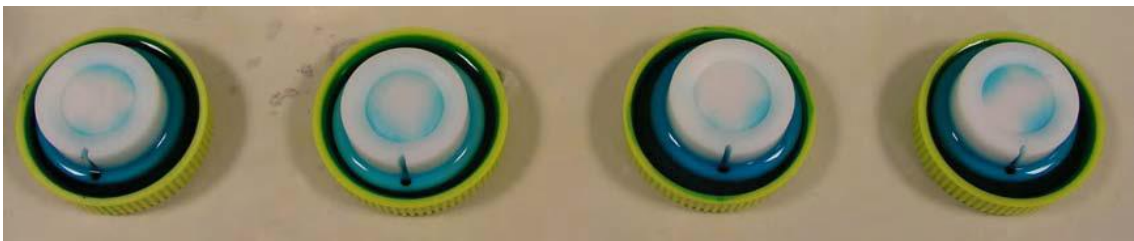

Figure 2.15. Pseudo DGT after 8 hours of deployment in dye solution (Wagner, 2004).

The annular rings from the duplicate DGT devices contained substantial amounts of metals that contribute approximately 40% of the total mass accumulated in the whole resin gel. From the relative standard deviation it is obvious that the leakage is highly variable between different DGT casings. The results also showed that the mass of metals accumulated in the internal disc agrees with the expected theoretical mass indicating that the leaked mass of metal was essentially contained within the annular ring. It was concluded that removal of the annular ring section was sufficient to ensure that only metal ions that enters to the device by diffusion processes through exposure window were measured.

2.5.3. Metal complexing capacity (MCC)

Physico-chemical form or speciation is an important characteristic used in an attempt to describe and quantify the bio-geochemical cycles of trace metals (Muller et al., 2001). According to Campbell (Campbell, 1995) the toxicity of metal ions is far greater than those of its complexes with naturally occurring ligands. That is why in situ complexation of trace metals by organic ligands is considered as the main control of bioavailability and toxicity of trace metals to phytoplankton (Campbell, 1995; Sunda, 1994). Ligands that are present in natural waters, such as humic acid, fulvic acids, some colloidal particles (ex. Fe_2O_3 , MnO_2 , etc) and other inorganic ligands could create inert complexes with metals. From their concentrations and stability constants with a certain metal it is possible to determine speciation of that metal and estimate the amount of free metal and inorganic metal species for the total metal present in a solution, which are potentially bioavailable and toxic.

Total concentration of these ligands, L_T , determines metal complexing capacity (MCC) (Plavšić et al., 1982; Ružić, 1982, van den Berg, 1982). For a given metal it is possible to group together different ligands and describe their overall behaviour towards certain "average" of properties with conditional stability constants K' .

Although different methods and protocols of direct characterization of metal-organic complex are reported in the literature (Wiramanaden et al., 2008), due to very low concentration of metals in seawater and experimental limitations of separation, extraction and measurement of different metal complexes, an alternate indirect approach in characterization of metal-organic ligand interactions is usually practiced by marine chemists (Bruland et al., 2000; Buck et al., 2012; Campos and Van Den Berg, 1994; Gerringa et al., 1995; Louis et al., 2009; Monticelli et al., 2010; Omanović et al., 1996; Plavšić et al., 2009; Ružić, 1982; van den Berg, 1982). It is based on the titration of the sample by the target metal at natural pH as schematically presented in Fig 2.16. Upon addition, metal is redistributed between different species, among them one (or group) is an "active" component which is measured, whereas the rest is considered to represent undetectable (organic) complexes. The most utilized technique for quantification of "active" components are electrochemical techniques due to their good sensitivity and selectivity. Basically two methods/protocols exist: anodic stripping voltammetry (ASV) and competitive ligand exchange adsorptive cathodic stripping voltammetry (CLE-AdCSV).

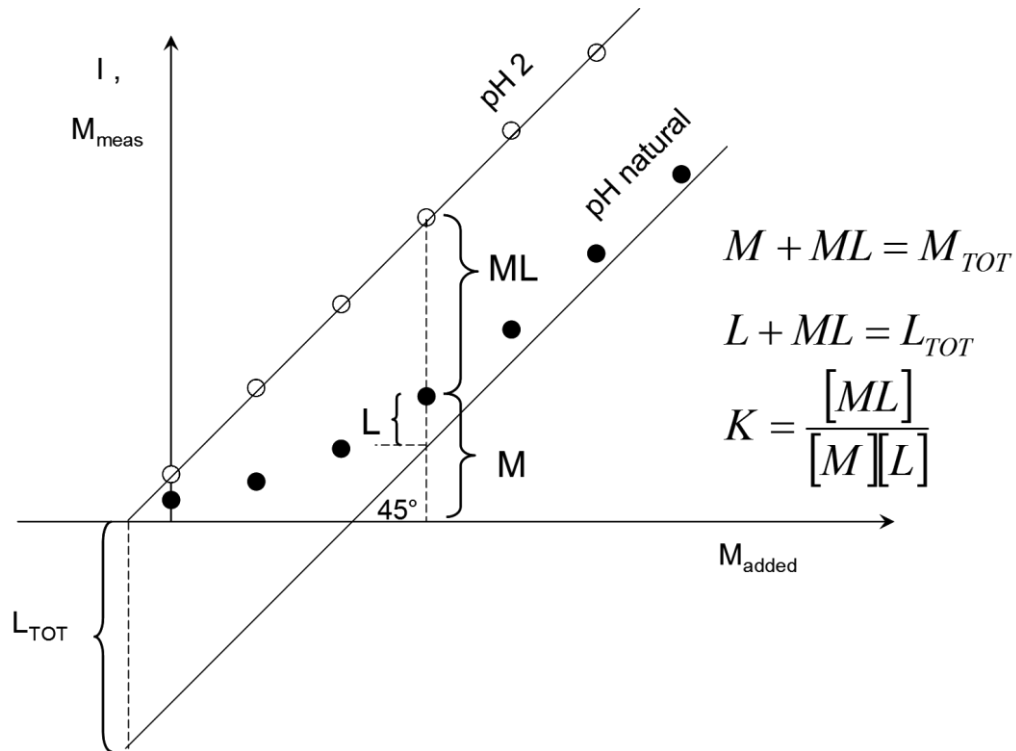

Figure 2.16. Basic experiment leading to metal complexing parameters determination. Example of one 1:1 metal-ligand complex.

2.5.3.1. Calculation of complexation parameters – a theory

When considering determination of metal speciation by common approach using electrochemical methods several assumptions and model simplifications should be considered. Principally, all calculations are based assuming discrete model of binding strengths (one or more ligand classes, L_i) with 1:1 metal-ligand stoichiometry. Furthermore, full equilibrium should be attained before measurement and measured intensities should correspond only to specie(s) predicted by the model. The effect of other competitive reactions as a consequence of increased metal concentration, is neglected.

Metal speciation calculations are based on the mass balance equations of metal (M) and ligands (L_i):

$$[M]_T = [M]_f + \sum_i [MX_i] + \sum_i [ML_i] \quad (19)$$

$$[L_i]_T = [L_i]_f + \sum_i [ML_i] + (\sum_{i,j} [M_j L_i]) \quad (20)$$

where T denotes total dissolved metal/ligand, f - free metal/ligand, $\sum_i [MX_i]$ - sum of all inorganic complexes, $\sum_i [ML_i]$ - sum of all organic complexes with studied metal, and $\sum_{i,j} [M_j L_i]$ sum of all other complexes of L with other cations (usually omitted in mass balance equations).

2. Literature overview

Stability constant (K') of metal complex with L , valid for a given solution composition, is given by:

$$K'_{ML} = \frac{[ML]}{[M]_f[L']} \quad (21)$$

where $[L']$ is the concentration of ligand non-bound to the metal.

In practice the sum of free metal concentration and its inorganic species is denoted as M' , which is related to free metal concentrations via inorganic side reaction coefficient, $\alpha_{IN} = [M]'/[M]_f$. Conditional stability constants of formed metal complexes are expressed either against $[M]'$ or $[M]_f$ so the conversion between the two is α_{IN} .

For one ligand model (1L) mathematical transformations of above equations provide well-known Ružić/van den Berg (R/VDB) (22), Scatchard (SC) (23) and Langmuir/Gerringa (L/G) (24) transformations (Gerringa et al., 1995; Ružić, 1982; van den Berg, 1982; Scatchard, 1949):

$$\frac{[M]'}{[ML]} = \frac{[M]'}{[L]_T} + \frac{1}{K' [L]_T} \quad (22)$$

$$\frac{[ML]}{[M]'} = -K'[ML] + K'[L]_T \quad (23)$$

$$[ML] = \frac{K'[L]_T[M]'}{1+K'[M]'} \quad (24)$$

While R/VDB and SC transformations produce linear relationship, from which total ligand concentration and conditional stability constant could be calculated from the slope and the intercept, the L/G relationship produce curvature shape, and non-linear fitting is needed.

For two or more ligand models, R/VDB (25) and L/G (26) equations could be extended for additional members on the right side:

$$\frac{[M]'}{\sum_i [ML_i]} = 1 / \left(\frac{[L_1]}{[M]_f + 1/K'_1} + \frac{[L_2]}{[M]_f + 1/K'_2} + \dots \right) \quad (25)$$

$$\sum_i [ML_i] = \frac{K'_1[L_1]_T[M]'}{1+K'_1[M]'} + \frac{K'_2[L_2]_T[M]'}{1+K'_2[M]'} + \dots \quad (26)$$

Both transformations produce curvature shape, providing information on number of ligand classes present. Estimation of complexing parameters could be performed either by separately treating different segments of a titration curve (quasi linear parts) (Bruland et al., 2000; Wu and Jin, 2009) or by non-linear fitting (Duran and Nieto, 2011; Garnier et al.,

2004b; Gerringa et al., 1995; Monticelli et al., 2010; Pižeta and Branica, 1997; Voelker and Kogut, 2001; Wu and Jin, 2009). An explicit analytical solution for more than one ligand model does not exist for Scatchard transformation.

Above relationships attained wide popularity because of their simplicity and relatively straightforward graphical visualization of number of ligand classes, however fitting the data in those transformations is not mathematically acceptable as the X and Y axes through the transformations became dependent. This problem could be overcome if explicit analytical relationships of $[M]'$ vs. $[M]_T$ are used for data fitting. For both, 1L and 2L-models, such relationships exist and are used for calculation of complexation parameters in literature (Duran and Nieto, 2011; Gerringa et al., 2014; Hudson et al., 2003; Lorenzo et al., 2007). For 1L-model the following analytical solution is valid:

$$[M]' = \frac{-a + \sqrt{a^2 + 4[M]_T/K'}}{2} \quad (27)$$

where $a = (-[M]_T + [L]_T + 1/K')$. Equation (27) is well known solution for roots of quadratic equation. Similarly, the explicit solution for 2L-model is the equation for roots of cubic equation, however due to its complexity it is not reported here, and authors are guided to the literature (Hudson et al., 2003; Pižeta and Branica, 1997).

The above equations apply directly to the titrations performed by ASV, where measured current corresponds directly to $[M]'$. In CLE-AdCSV method, a competing ligand is added in solution and equation (19) is extended for additional member:

$$[M]_T = [M]_f + \sum_i [MX_i] + \sum_i [ML_i] + \sum_i [M(AL)_i], \quad (28)$$

where $\sum [M(AL)_i]$ is the sum of concentrations of all metal species formed by added ligand, each defined by conditional stability constant which has to be known:

$$K'_{MAL_i} = \frac{[M(AL)_i]}{[M]_f [AL]_f^i} \quad (29)$$

It is assumed that the concentration of AL is sufficiently high that the inorganic species ($[M]'$) could be neglected. In CLE-AdCSV, measured signal is related to the reduction of accumulated $[MAL]_i$ complex(es). From the equation (29) it follows that

$$[M(AL)_i] = K'_{MAL_i} [M]_f [AL]_f^i \quad (30)$$

Conditional stability constants of $M(AL)_i$ complexes are expressed either against $[M]_f$ or $[M]'$ for a given solution composition. Additionally, it is assumed that the unbound

concentration of added ligand ($[AL]_f$) is equal to its total concentration ($[AL]_T$), because its concentration is much higher than that of metal along the titration curve.

Like for inorganic side reaction coefficient, the conversion factor between labile ($[M]'$) or free ($[M]_f$) metal and $[MAL]$ is the side reaction coefficient of AL defined as:

$$\alpha_{AL_i} = K'_{MAL_i}[AL]_T, \text{ or } \alpha'_{AL_i} = K'_{MAL_i}[AL]_T \quad (31)$$

In case that more than one complex with M is formed with AL , both should be considered in calculation of α_{AL} . Using α_{AL} , measured currents corresponding to $[MAL]$ are transformed into $[M]'$ or $[M]_f$, so that all above equations for calculation of complexation parameters could be used for CLE-AdCSV method as well.

2.5.3.2. Design of the experiment

Choice of deposition potential for ASV type of measurements is important since only free metal and metal from labile complexes should be measured. Thus checking of the sample by performing a pseudopolarographic type of measurement should be done (Omanović and Branica, 2003). Most inorganic metal species are labile - electroactive. The inert metal complexes, like complexes with humic and other organic ligands, at the same accumulation potential are electroinactive. Using more negative potential of accumulation it is possible to achieve reduction of inert complexes. It is therefore important to choose suitable deposition potential (that will reduce all free and bound metal-labile, but not inert metal complexes) in determining the MCC. Selection of deposition potential is based on recorded pseudopolarogram (PP) (Fig. 2.17) (Omanović et al., 1996; Louis et al., 2009). A pseudopolarogram shows the dependence of the anodic oxidation peak current of accumulated metals in dependence on varying deposition potential.

In designing of the experiment one should take care of properly distributing metal additions. Logarithmic additions based on measuring the ambient metal concentration have been adopted as the most useful ones (Garnier et al., 2004a). Choice of other ASV parameters (scanning technique, modulation amplitude, scan rate, etc.) should be done, and optimized vis-à-vis each other and the sensitivity of the measuring system. Once it is decided and measurements are done, it should result in a titration curve, a data set of signal intensity versus added metal as shown in Fig. 2.18. that should be fitted to a chosen model. As mainly accepted in the recent literature, and supported by the theory, complexometric titration curves should be fitted to models of one or two (exceptionally more) ligands that form

complexes with titrated metal ions (in our case with copper(II) ions) (Pižeta et al., 2015. and references cited there in). A state-of-the-art software ProMCC was on disposition (Omanović et al., 2015), where to few key points attention should be paid, in order to extract the most reliable information from the data sets (Fig 2.18).

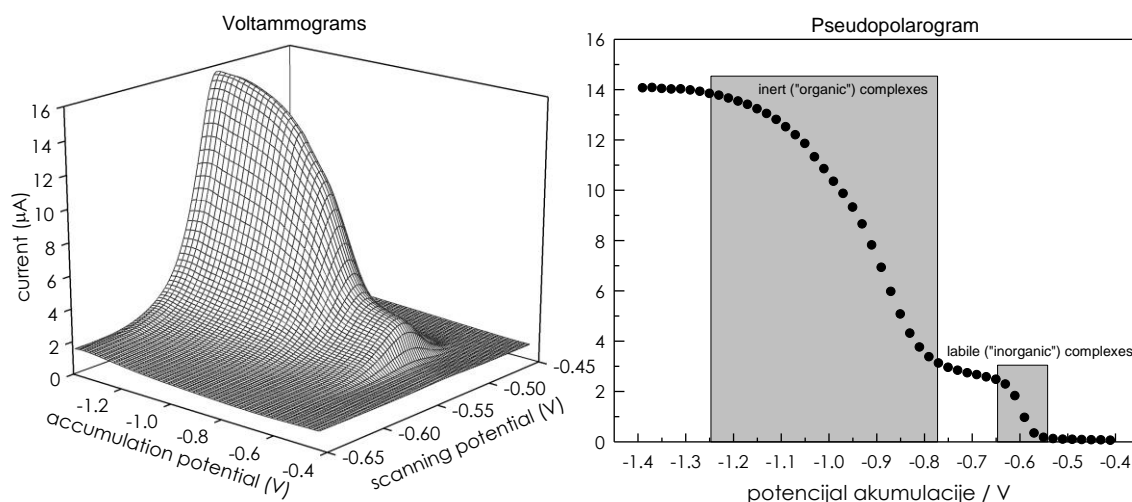

Figure 2.17. Voltammograms of Pb (left) recorded to construct a pseudopolarogram (right). Marked areas show the reduction waves of labile (“inorganic”, more positive) and inert/strong (“organic”, more negative) metal complexes.

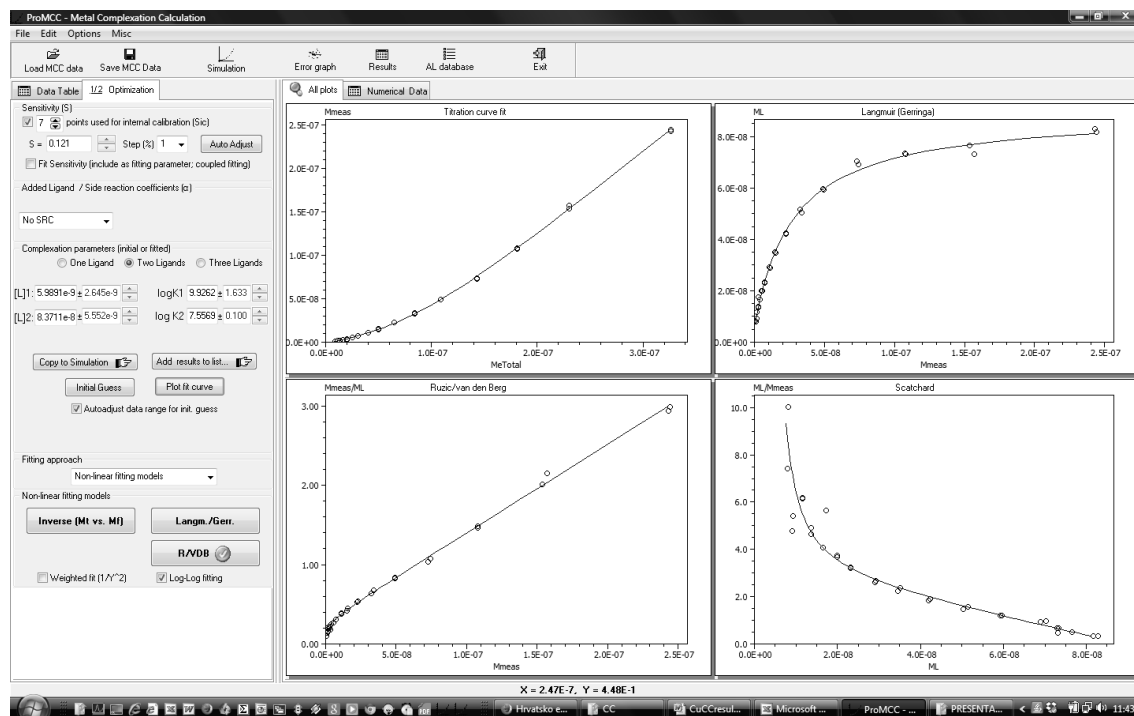

Figure 2.18. Snapshot of ProMCC software showing plots of titration curve (top left), Langmuir/Gerringa (top right), R/VDB (bottom left) and Scatchard (bottom right) plots. Data were fitted applying R/VDB log-log fitting routine (blue curve).

3. Experimental part and methodology

3. Experimental part and methodology

3.1. Study site

The karstic Krka River that is mainly encompassed within the Krka National Park, is situated on the eastern coast of the Adriatic Sea (Croatia). Its catchment area consists of carbonate rocks and deposits. The content of calcium ions determined at the mouth of the river is $0.0024 \text{ mol dm}^{-3}$ (Bilinski et al., 1991) and the pH is about ~ 8.3 . The measured flow over the last 50 years is between 5 and $450 \text{ m}^3 \text{ s}^{-1}$ with an average annual flow of between 40 and $60 \text{ m}^3 \text{ s}^{-1}$. The climate in this area is typical for the Mediterranean with hot, dry summers, and quite temperate, wet winters.

The river is characterized by numerous lakes formed by tufa barriers, each finishing with waterfalls. After the last and largest waterfall (Skradinski buk) 23 km long, salt-wedge type Krka River estuary starts (Fig 3.1). A few small villages are located along the foremost part of the estuary shoreline with approximately 4000 permanent inhabitants. The majority of the population lives in the lower part of the estuary in Šibenik city (19th km) and surrounding area (around $35,000$ permanent inhabitants). However, during the summer, the population increases several times due to tourism, mainly because the Krka River estuary is a very attractive nautical destination. Thus, along with the permanent harbour activities in Šibenik town, the nautical tourism (more than 1000 berths) is considered to be a serious periodic (seasonal) anthropogenic treat for the estuary ecosystem. Although Krka National Park, with over $700,000$ visits per year, undergoes high touristic pressure, it is not considered to be a potential source of pollution for the estuary, because the activities and waste water management within the Park are strictly controlled and processed. For a long time, the waste waters from Šibenik were discharged directly into the estuary. Since 2007, the treated waste waters has been discharged into the open sea, about 5 km from the coast at a depth of 60 m . Numerous aquaculture plants (~ 20 fields) for mussels farming (*Mytilus galloprovincialis*) are located mainly in the lower part of the estuary (Fig. 3.1 and Fig 3.2). A heavy industry is not currently developed along the estuary. For years, the main treat was the factory of electrodes and ferroalloys close to Šibenik (Fig. 3.1.) This zone was rehabilitated after production stopped in 1995.

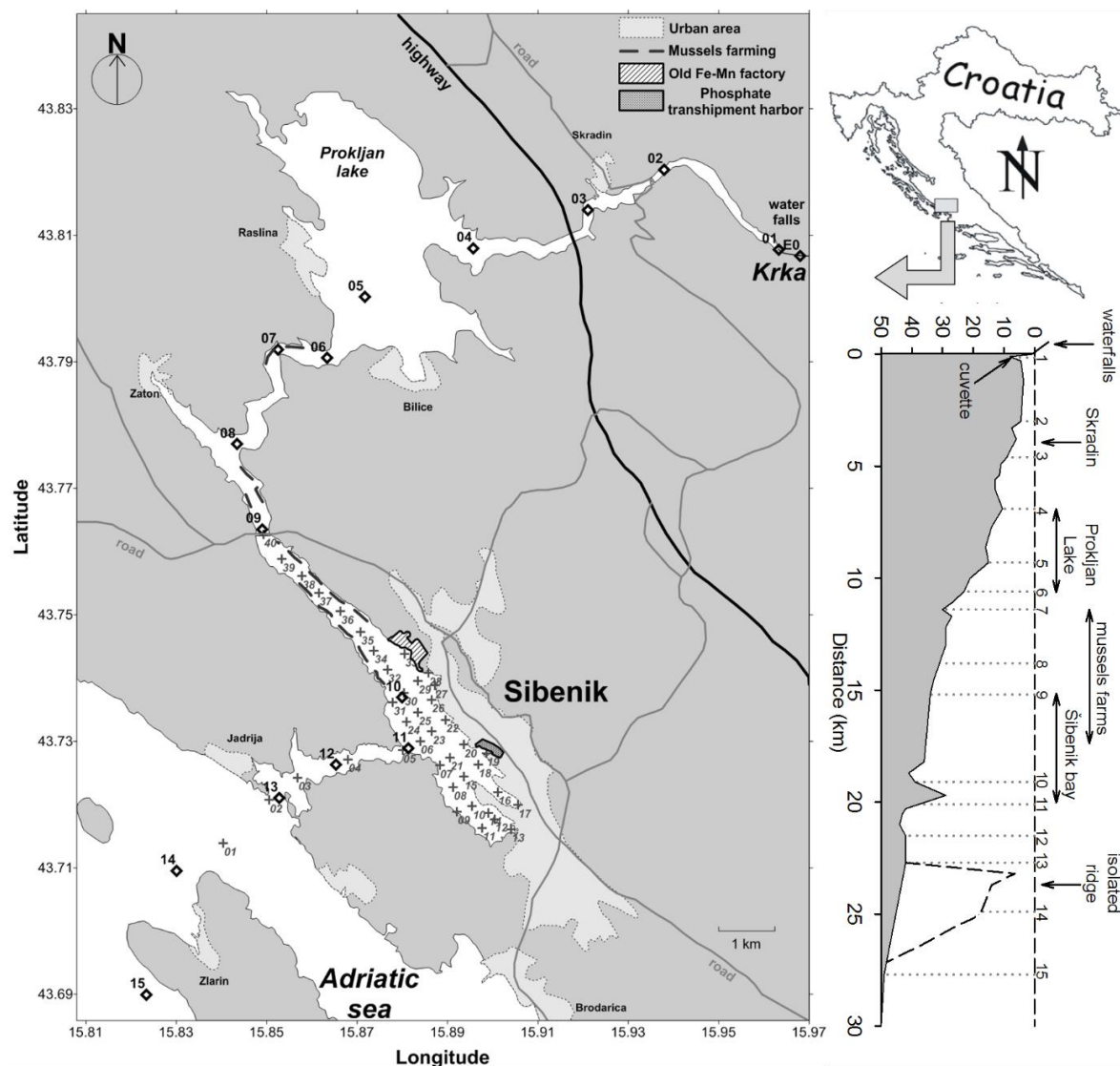

Figure 3.1. Map of the Krka River estuary with marked transect (open diamonds) and high-resolution mapping (crosses) sampling sites. Right plot shows horizontal bottom depth transect with marked sites and specific regions.

Due to the low tidal range and sheltered geography this micro-tidal, salt-wedge estuary is permanently vertically stratified. The three separate layers in a vertical profile exist all along the estuary and could be easily spotted by scuba diving: the upper brackish layer (river water layer), the freshwater - seawater interface (FSI; middle layer) and the bottom seawater layer. Halocline with a steep salinity gradient within 1 m range of FSI is usually formed at a depth of between 1.5 and 3.5 m, and its shape primarily depends on the location, weather conditions (wind, precipitation) and hydrological conditions (Krka River flow).



Figure 3.2. Mussel farms in the Krka River estuary

As a result of seawater entrainment, the salinity in the brackish layer increases from the head of the estuary towards its mouth. Tidal influence is low (the average is 20 cm and the maximum around 50 cm). Due to the absence of significant anthropogenic sources along the lower part of the Krka River, water that enters the estuary is exceptionally clean in terms of trace metal concentrations (Cukrov et al., 2008) and biogeochemical markers (Scribe et al., 1991), and is comparable to pristine world rivers (Elbaz-Poulichet et al., 1991). According to Legović (1991), the exchange time of both brackish water and seawater is mainly dependent on the Krka River inflow: for brackish water in winter, it is between 6 and 20 days, and in summer, up to 80 days, whereas for seawater it is between 50 and 100 days in winter, and up to 250 days in summer.

3.2. Chemicals and solutions

The following chemicals were used in this work:

- Ultra-pure water (UPW), ASTM type I, 18.2 M Ω cm (Merck-Millipore)
- 65 % nitric acid (*reagent grade* and *suprapur*, Merck/Kemika)
- AAS standard solutions of metals 1 g L⁻¹ (Zn, Cd, Pb, Cu, Ni and Co; Fluka/Merck)
- 10⁻² M Nioxime solution (1,2-Cyclohexanedione dioxime) (for Ni and Co analysis)
- Boric acid (*suprapur* Merck or *Trace metal basis*, Sigma)
- Sodium hydroxide, 30% solution (*suprapur*, Merck)
- Sodium acetate anhydrous, 99,99 (*suprapur*, Merck)
- Liquid Hg (for working electrode)

- 1 M azide solution (NaN_3) (Aldrich)
- ICP multi-element standard solution (24 elements in dilute HNO_3)
- Indium standard solution (1000 mg L^{-1}) – as internal standard for ICP-MS
- Pressurised nitrogen (N_2) gas, 150-200 bar, 5.0 purity

All solutions were prepared by using MQ water. No additional purification of any solution was done.

3.3. Instrumentation, devices and consumables

- PGSTAT 128N or μ AUTOLAB3 potentiostat/galvanostat controlled by GPES (General Purpose Electrochemical System) 4.9 software (Utrecht, The Neatherland)
- High Resolution Inductively Coupled Plasma Mass Spectrometer, HR ICP-MS (Element 2, Thermo, Finnigan, Bremen, Germany)
- Automated dosing system (Cavro XE 1000 or XL 3000 syringe pumps, Tecan, Swiss)
- Hach Lange multiprobe HQ40D, OTT MiniSonde 4a and DS5 multiprobe,
- DGT probes (passive samplers) (DGT Research Ltd., Lancaster, United Kingdom)
- Horizontal water sampler van Dorn type 2.2 L (Wildco)
- Membrane filters, cellulose-nitrate: $0.45 \mu\text{m}$ (Sartorius)
- Syringe-mounted capsule filters: $0.2 \mu\text{m}$ cellulose-nitrate (Sartorius, Minisart)
- Glass microfiber filters, $0.7 \mu\text{m}$, grade GF/F (Whatman)
- 50 mL Plastic syringe
- Polycarbonate filter holder (Sartorius, model 16511)
- 10 mL glass tubes with silicon cap
- 24 mL glass tubes with silicon/Teflon septum (Wheaton)
- High density polyethylene (HDPE) bottles, various volume (NALGENE)
- Fluorinated ethylene propylene (FEP) and Perfluoroalkoxy (PFA) bottles, various volume, (NALGENE)

3.4. Cleaning (washing) procedure

Trace metal analysis requires an extremely careful and lengthy cleaning process, because small amounts of impurities from a variety of sources may contaminate samples. For sampling and sample storage, only plasticware was used. Bottles were made of high or low

density polyethylene (HDPE, LDPE), fluorinated ethylene propylene (FEP) or perfluoroalkoxy (PFA), all by Nalgene. All the plasticware was subjected to a thorough cleaning procedure.

Three major steps were used in the cleaning process: pre-cleaning (weak detergent), reagent grade acid cleaning and trace metal grade acid cleaning. For the final rinse, ASTM Type I water (labelled here as MQ water, 18.2 M Ω , Millipore, USA) was used.

After the preliminary pre-cleaning with a weak detergent (only new bottles), plastics (bottles, syringes, sampler, DGT holders) were first cleaned with 10% HNO₃ (analytical reagent grade), rinsed several times with MQ water, then cleaned with a mixture of MQ water and 1-2% trace metal grade HNO₃, rinsed with MQ water and finally filled with MQ water until use. Before the final filling, bottles were rinsed with the sample. Filter membranes were rinsed by passing through ~250 mL of MQ water. Glass tubes used for DOC analysis were cleaned with 10% HNO₃ (analytical reagent grade), rinsed with MQ-water, and calcinated for 4 hours at 450°C. Before use, the horizontal water sampler and DGT holders were conditioned in the ambient water (brackish or seawater) for at least 24 hours.

Sample handling and preparation of standard solutions were performed using polyethylene gloves within a laminar cabinet (HEPA 13) when appropriate in order to avoid contamination of solutions and samples.

3.5. Sampling protocols

Four field campaigns, covering different parts/transects within the estuary (aiming to investigate trace metal distribution and behaviour) were conducted: the first and second along the whole estuary transect, involving two contrasting periods of the year (July 19th 2011 and February 28th 2012), covering 15 sites (KE-1 to KE-15); the third, “high-resolution” mapping, within the Šibenik Bay (July 20th, 2012) covering 40 sites (SB1 to SB 40); the fourth, a “cross-section” sampling (transversal transect, direction: left to right estuary bank, 0.6 km in distance) in Šibenik Bay (August 30th 2013). Sampling locations are presented in Fig. 3.1, while details about sampling locations are given in Tables 3.1, 3.2 and 3.3).

Additionally, the site in front of the marine station Martinska and the site within nautical marina Mandalina were selected for trace metal speciation studies.

3.5.1. Sampling along the estuary transect

During the estuary transect campaigns (July 19th 2011 and February 28th 2012), three samples were collected along the vertical profile at each station. An additional freshwater sample was collected from the Krka River during the first campaign, which, together with surface samples at the first sampling site (KE-1/1) was considered to be a freshwater end-member. The seawater sample at the last site (KE-15/1) was considered to be a seawater end-member.

Table 3.1. Sampling locations along the Krka River estuary transect

Site ID	Distance from waterfalls (km)	Latitude	Longitude
KE-1	0.1	43.80771	15.96324
KE-2	3.0	43.82039	15.93794
KE-3	4.6	43.81401	15.92104
KE-4	6.9	43.80796	15.89567
KE-5	9.3	43.80024	15.87167
KE-6	10.6	43.79008	15.86339
KE-7	11.4	43.79096	15.85244
KE-8	13.8	43.77546	15.84437
KE-9	15.2	43.76353	15.84907
KE-10	19.1	43.73690	15.87998
KE-11	20.1	43.72885	15.88138
KE-12	21.5	43.72557	15.86525
KE-13	22.7	43.72103	15.85275
KE-14	24.9	43.70953	15.83010
KE-15	27.7	43.68997	15.82335

Vertical profiles of the main physico-chemical parameters (salinity, temperature, pH, and dissolved oxygen) were measured in-situ, at each site by multiprobes (OTT Minisonde 4a or DS5 and Hach Lange HQ40D), calibrated before each campaign (Fig 3.3).

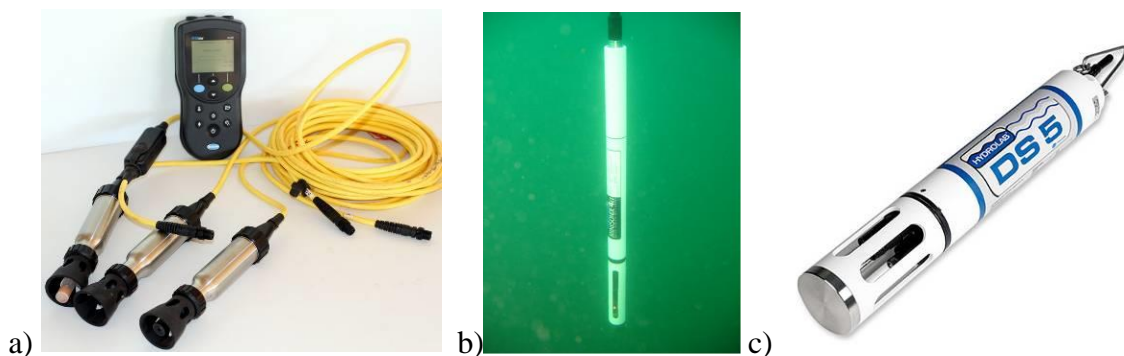

Figure 3.3. Multiprobes for measurement of physico-chemical parameters (a) Hach Lange HQ40D, (b) OTT Minisonde 4a and (c) OTT multiprobe DS5

At the 15 sites of the estuary transect campaigns, samples were collected using a van Dorn type 2.2 L horizontal water sampler (Wildco) at three depths (Fig. 3.4), covering three different vertical salinity sections: a brackish, a FSI and a seawater layer.



Figure 3.4. Horizontal water sampler, and the filling of a FEP bottle with a sample taken with the horizontal sampler

The brackish layer was sampled at a depth of 0.5 m, while the sampling depths at the halocline (FSI) and in the seawater layer were selected according to measured vertical salinity profiles and the total water column depth, respectively. Due to the relatively thin layer of the FSI layer (e.g. ~30 cm) in the upper estuary, sampling was repeated until a representative sample, with the salinity within ± 5 range compared to the mean value between brackish and seawater layer, was taken. On station KE-1, six samples were taken due to anoxic conditions observed in the bottom seawater layer.

The pre-cleaned FEP bottles were used for sample storage. The FEP bottle was firstly thoroughly rinsed with the sample and 1 L of the sample was then taken and stored in a portable refrigerator. Sample treatment (filtering and acidification) was performed immediately upon arrival at the laboratory.

3.5.2. “Cross-section” (transversal) transect sampling

A grab sampling technique was used for surface sampling at 10 sites across the transversal transect of the estuary: a clean 1 L FEP bottle was mounted at the end of a ~3 m aluminium telescopic pole and after rinsing three times with the ambient water, the sample was taken

from the boat at a depth of about 0.5 m (Fig 3.5.). Salinity was measured using a refractometer once samples were delivered to the laboratory.

Table 3.2. Sampling locations of “cross-section” surface mapping within the Šibenik Bay

Site ID	Latitude	Longitude
S1	43.738170	15.876634
S2	43.738546	15.877596
S3	43.738786	15.878850
S4	43.739011	15.879680
S5	43.739347	15.880553
S6	43.739565	15.881069
S7	43.739780	15.881642
S8	43.739973	15.882066
S9	43.740184	15.882586
S10	43.740477	15.883197



Figure 3.5. Grab sampling of the surface layer during “cross-section” and „high-resolution“ sampling.

3.5.3. Sampling in the Šibenik Bay

The same grab sampling technique described previously, was used for “high-resolution” surface sampling at 40 sites in the Šibenik Bay. When the wind was causing slight boat movement, samples were taken from the “front” side in regards of the direction of the boat movement.

Physico-chemical parameters were recorded for all stations with multiprobes.

Table 3.3. Sampling locations of “high-resolution” surface mapping within the Šibenik Bay

Site ID	Latitude	Longitude
SB 1	43.71387	15.84044
SB 2	43.72070	15.85055
SB 3	43.72426	15.85688
SB 4	43.72711	15.86796
SB 5	43.72859	15.88008
SB 6	43.73002	15.88397
SB 7	43.72618	15.88825
SB 8	43.72274	15.89129
SB 9	43.71890	15.89210
SB 10	43.71970	15.89545
SB 11	43.71630	15.89770
SB 12	43.71770	15.90040
SB 13	43.71610	15.90410
SB 14	43.71870	15.89900
SB 15	43.72437	15.89366
SB 16	43.72198	15.90112
SB 17	43.71991	15.90562
SB 18	43.72630	15.89676
SB 19	43.72810	15.89857
SB 20	43.72944	15.89360
SB 21	43.72744	15.89053
SB 22	43.73340	15.88957
SB 23	43.73153	15.88656
SB 24	43.73310	15.88097
SB 25	43.73456	15.88348
SB 26	43.73657	15.88643
SB 27	43.73881	15.88713
SB 28	43.74080	15.88580
SB 29	43.73953	15.88344
SB 30	43.73765	15.88040
SB 31	43.73615	15.87791
SB 32	43.74131	15.87674
SB 33	43.74380	15.88050
SB 34	43.74434	15.87372
SB 35	43.74727	15.87079
SB 36	43.75054	15.86636
SB 37	43.75347	15.86156
SB 38	43.75610	15.85778
SB 39	43.75881	15.85333
SB 40	43.76270	15.84931

3.5.4. Sampling and DGT deployment at Martinska (“clean”) and nautical marina (“polluted”) sites

After a general examination of the status of trace metal distribution in the estuary, according to measured concentrations of trace metals, two sites were selected to represent “clean” and “polluted” estuary regions (Fig. 3.6). Experiments on those sites were conducted three times in summer (July 8th to 13th, 2009; July 19th to 24th, 2010; July 13th to 18th, 2011) and two times in winter (January 30th to February 4th, 2010 and March 1st to 6th, 2012), over the course of four years.



Figure 3.6. „Clean” (Martinska station) and “polluted” site (nautical marina Mandalina)

At these sites, over the course of a few days, vertical profiles of physico-chemical parameters were measured every two to three hours from early morning to late in the evening. Figure 3.7 shows a typical set of temperatures, salinity and dissolved oxygen measurements collected during “deployment” days. The selection of depths for DGT deployment was based on measured physico-chemical parameters (Table 3.4).

Table 3.4. Sampling and DGT deployment depths for different campaigns (BW – brackish water, FSI – freshwater-seawater interface and SW – seawater)

Layer	2009 07	2010 02	2010 07	2011 07	2012 03
BW	0.50	0.50	0.50	0.50	0.50
BW	1.20	1.20	1.30	1.30	1.30
FSI	2.00	2.00	1.90	1.90	2.10
FSI	2.50	2.50	2.60	2.50	2.60
SW	3.50	3.50	3.50	3.50	3.90
SW	8.00	8.00	8.00	8.00	7.30

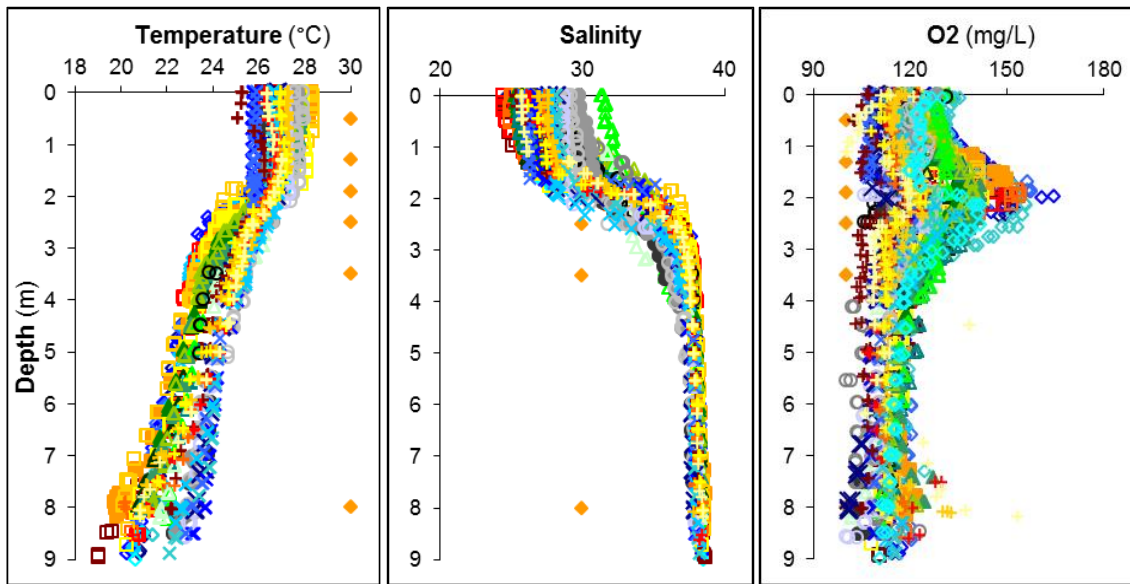

Figure 3.7. Vertical profiles of physico-chemical parameters at the “clean” Martinska site.

Before the experiment, DGT holders were conditioned in the ambient water (brackish or seawater) for at least 24 hours. Before deployment, DGT holders were attached to the rope at defined distances from the buoy and sequentially filled with DGT probes (from the bottom to the surface) so that holders with DGT-probes were immediately placed back in the water (Fig 3.8).



Figure 3.8. Setup of DGT holder positions (depth) and procedure of DGT deployment.

In order to maintain DGT devices at defined depth (salinity range), due to the influence of the tide (~50 cm in the Krka River estuary), wind and waves, a “counter-weight” mechanism is employed. The rope keeping DGT devices at pre-defined distances from the buoy (Fig. 3.9a) was over the pulley on the bottom connected to the air-filled bottle (5 L) which served as counter-weight (Fig 3.9.b).

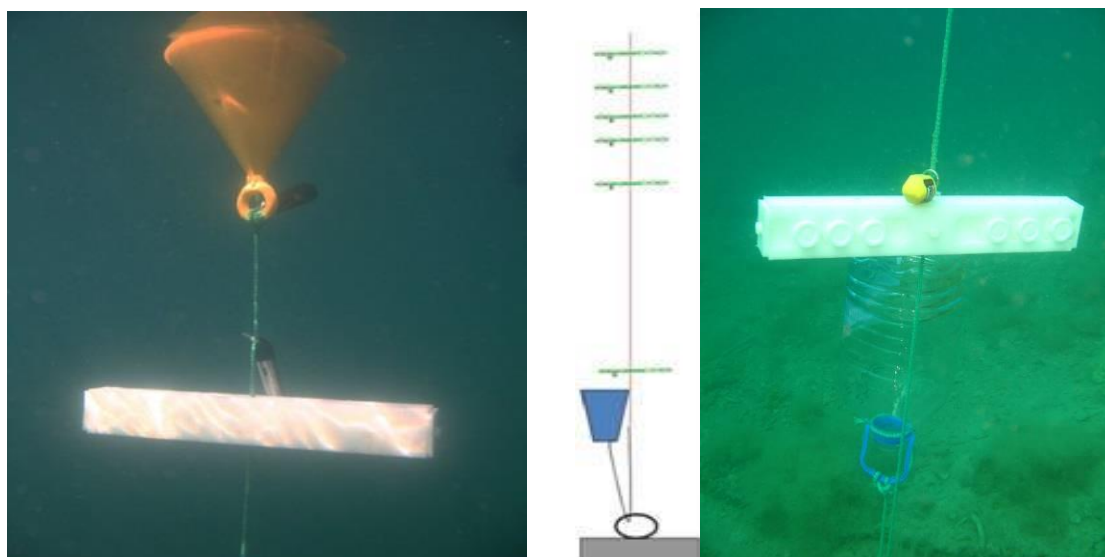

Figure 3.9. Buoy at the surface to which the rope was attached (left) and schematic representation and actual photo of the counter-weight (right) with holder filled with 3-replicates of OP-DGT and RP-DGT (at 8 m)

Two types of DGT device were used: open pore (OP) and restricted pore (RP). Each time DGT devices were deployed in triplicate at each depth (Fig. 3.9). A temperature/depth sensor was attached to each DGT holder in order to monitor temperature and to control the deployment depth (Fig. 3.9B, yellow object).

DGT samplers were deployed in water for defined period of time (Table 3.5). During the deployment period DGT-probes were constantly moving in the holder due to the influence of waves and wind. After the defined period of deployment DGT samplers were taken from the water column, washed with MQ water, put away in pre-prepared bags and marked.

Table 3.5. DGT deployment times

Campaign	Hours of deployment
2009 07	127
2010 02	118
2010 07	120
2011 07	123
2012 03	119

During the deployment time, ~5 days, discrete samples were taken by a scuba diver at each DGT depth (see sketch on the right) in 1 L FEP bottles, twice per day in summer, and once in winter, while physico-chemical parameters in water columns were measured six to eight times per day. Samples taken by the scuba diver were delivered to the laboratory immediately after sampling, filtering and storage

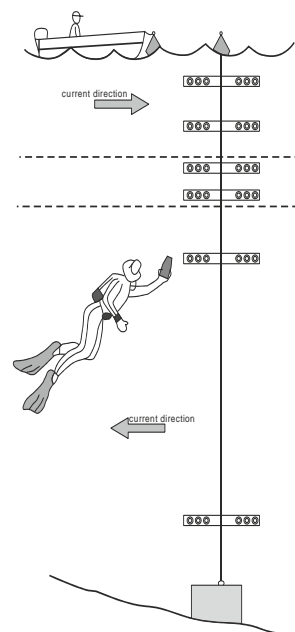

3.6. Sample preparation

3.6.1. Unfiltered samples

A subsample of an unfiltered sample was transferred from a 1 L FEP bottle (from estuary transect sampling and “two sites”) into a 250 ml FEP/PFA bottle. Composite unfiltered samples (collected during the 5 days of DGT deployment) for each DGT-depth were prepared by collecting 40 g of sample after the scuba-diver sampling (once in winter and twice in summer). Concentrations in unfiltered samples in this study represent acid-leachable (quasi-total) metal concentrations, but within the text are referred to as total metal concentrations.

3.6.2. Filtration under nitrogen pressure

Samples were filtered under the nitrogen pressure (~1 bar) through 0.45 μm (47 mm in diameter) cellulose-nitrate membrane filters (Sartorius) using Sartorius polycarbonate filter holder (model 16511) (Fig. 3.10a). Before filtration of each sample, filter unit and filter were firstly rinsed with ~250 mL MQ water, and then with ~250 mL sample, which was partly used for rinsing of bottles. After this two-step rinsing, ~250 mL of sample was filtered directly into FEP/PFA bottles. Composite samples were prepared in the same way as previously described for un-filtered samples.

Once collected, filtered and unfiltered samples for trace metal analysis were acidified ($\text{pH} < 2$) by addition of HNO_3 (*suprapur*). Samples for Cu speciation measurements (composite, filtered) were left at their natural pH and were preserved with 20 μL of 1 M NaN_3 and refrigerated at 4°C until analyses started.

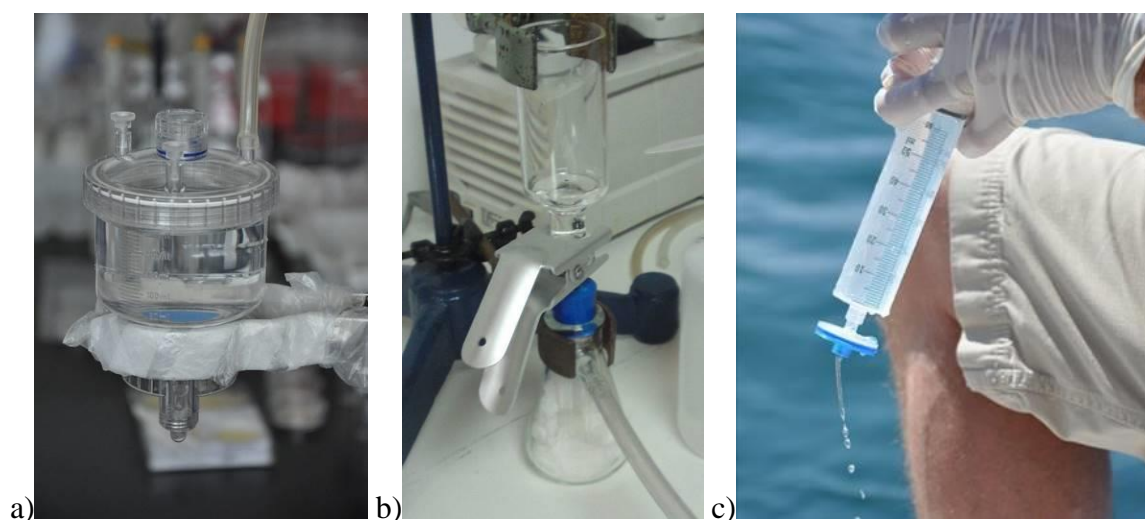

Figure 3.10. (a) Polycarbonate system for filtration under nitrogen pressure, (b) glass system for filtration under vacuum and (c) “on-board” filtering

3.6.3. Filtration under vacuum

All tubes, glass filters and glass filtration systems used for dissolved organic/inorganic carbon (DOC/DIC) and particulate organic carbon (POC) analyses were previously cleaned with 10% HCl (pro analysis, Fisher Scientific) and rinsed with MQ water, then calcinated for 4 h at 450°C.

Around 300 mL was filtered under vacuum using a glass filtration system (Wheaton) with glass filters (Whatman GFF, 25 mm, 0.7 μm) (Oursel et al., 2013), while for high-resolution surface sampling, an aliquot of an on-board filtered sample was used (Fig 3.10b).

The bottle containing ~ 300 mL of sample was weighed before filtering, and when the sample’s drop rate became very low, the rest of the sample in the bottle was weighed again. The difference in mass is the amount of sample which passed through the filter membrane. Samples for dissolved organic carbon (DOC) were prepared in this way, and the filter was used for POC determination. GF/F filters were saved for POC measurement. Filtered samples were stored in 24 mL glass tubes (Wheaton, equipped with Teflon/silicone septa) and preserved with 25 μl of 1 M NaN_3 .

Suspended particulate matter (SPM) was quantified by calculating the difference between the mass of the glass filter before and after filtration. Drying to constant mass was performed at 40°C.

3.6.4. On-board filtration

During “high-resolution” surface sampling in Šibenik Bay, around 250 mL of sample was immediately filtered on-board using 0.2 μm cellulose-nitrate, syringe-mounted, capsule filters (Minisart, Sartorius) that were previously cleaned in the laboratory (Fig 3.10c). Both filtered and un-filtered samples were collected in 250 mL FEP/PFA bottles and stored in a portable refrigerator.

3.6.5. Sample preparation for electrochemical measurement

All samples for trace metal analyses (filtered and unfiltered) were acidified with ultrapure concentrated HNO_3 (*suprapur* Merck or *TraceSelect* Fluka) to a pH of < 2 (500 μl of acid in 250 mL of sample) and irradiated directly in the FEP/PFA bottles with UV light (150 W mercury lamp, Hanau, Germany) for at least 24 h in order to decompose natural organic matter (Omanović et al., 2006). Composite samples for Cu speciation measurements were preserved with NaN_3 and stored in a refrigerator.

3.6.6. DGT resin gel retrieval

Retrieval of DGT resin gel was performed immediately after collection of DGT devices from the water. No biofouling on DGT devices was observed upon retrieval from the water after ~5 days of deployment (Fig 3.11). DGT-devices removed from the holder were first rinsed with MQ water and then stored in properly marked plastic zip bags after removing excess MQ water.

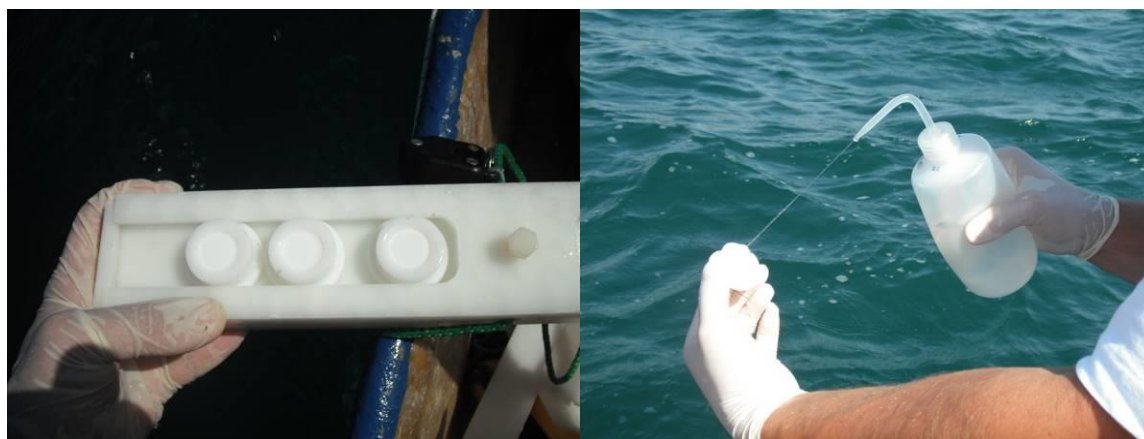

Figure 3.11. Retrieval and pre-treatment of DGT-devices.

3. Experimental part and methodology

A plastic-covered screwdriver was used to twist the covering cap. Acid/MQ-cleaned plastic forceps were used to remove the membrane filter paper cover and diffusive gel, and to transfer resin gel into the pre-cleaned plastic tube (2 mL, Eppendorf) as shown in Fig. 3.12. Finally, 1.5 mL of 1 M HNO₃ (*suprapur*) was added to the tube in order to extract metals from the resin. The resin gel was taken out of the tube after ~48 h. DGT extracts (eluates) were analyzed for metal content within 1-2 months.

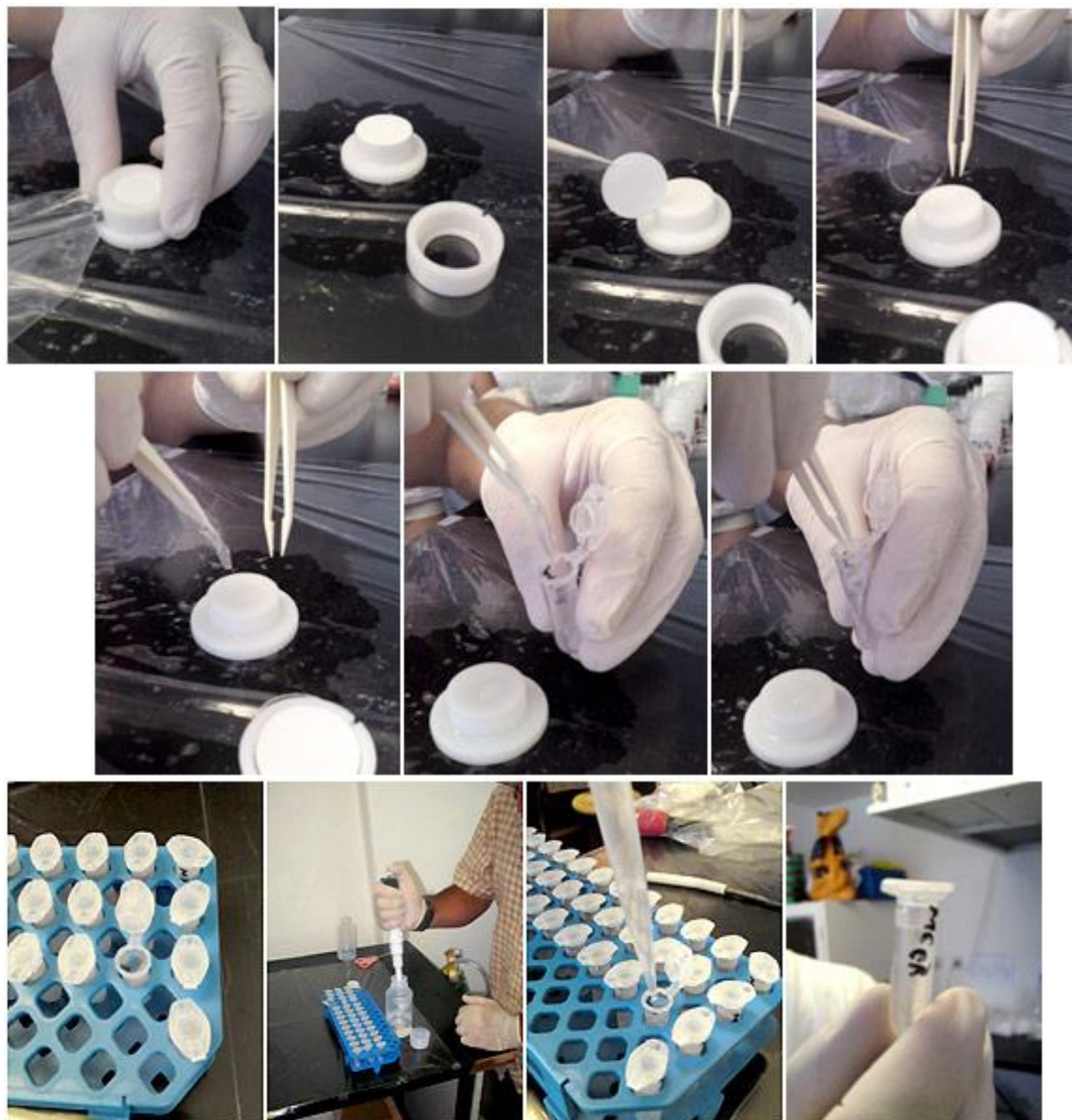

Figure 3.12. Retrieval and pre-treatment of DGT resin gel.

3.7. Analytical measurement

3.7.1. Multi-elemental analysis by ICP-MS

A multi-elemental analysis of DGT-extracts was performed by HR ICP-MS (Element 2, Thermo) at the Ruđer Bošković Institute (RBI) at $3\times$ dilution. From a total of a 1.5 mL aliquot of the sample, 0.7 mL were used in preparation for measuring the sample. Samples were diluted by 2% HNO_3 (*suprapur*). Indium (In) was used as an internal standard (IS). The quantification of metal concentrations was performed using external calibrations.

3.7.2. Voltammetric analysis of trace metals

Trace metal concentrations were determined using differential pulse stripping voltammetry: anodic (DPASV) for Zn, Cd, Pb, and Cu, and adsorptive cathodic (DPAdCSV) for Ni and Co (10^{-5} M Nioxime was used as a complexing ligand) in the water samples with the parameters given in Table 3.6. The parameters used for measurements are adopted from Omanović (Omanović et al., 2006) for DPASV, and from Vega and van den Berg (Vega and Van den Berg, 1997) for DPAdCSV. Concentrations of metals were determined using the standard addition method.

Table 3.6. Parameters for anodic and adsorptive cathodic differential pulse stripping voltammetry

Parameters	DPASV		DPAdCSV
	Cd, Pb, Cu	Zn	Ni, Co
Deposition potential (V)	-0.8	-1.2	-0.7
Duration (s)	600	60-120	60-120
Desorption potential (V)	-1.4	0	0
Duration (s)	2	0	0
Equilibration time (s)	10	10	10
Modulation time (s)	0.05	0.05	0.05
Interval time (s)	0.1	0.1	0.1
Initial potential (V)	-0.75	-1.15	-0.7
End potential (V)	0.02-0.1	-0.75	-1.2
Step potential (V)	0.00195	0.00195	0.00195
Modulation amplitude (V)	0.04005	0.04005	0.04005

Measurements were carried out at room temperature ($\sim 25^{\circ}\text{C}$) on Autolab potentiostat/galvanostats ($\mu\text{Autolab3}$ or PGSTAT128N) controlled by GPES (General Purpose Electrochemical System) 4.9 software in a three-electrode cell (663 VA Stand, Metrohm) (Fig. 3.13). A glass or Teflon electroanalytical cell with a working volume of from 10 to 100 mL was used for measurements. A three electrode system, consisting of:

1. a platinum wire, serving as the counter electrode
2. an $\text{Ag}|\text{AgCl}|\text{sat. NaCl}$ electrode, serving as the reference electrode
3. a hanging mercury drop (HMDE) (0.25 mm^2), serving as the working electrode.

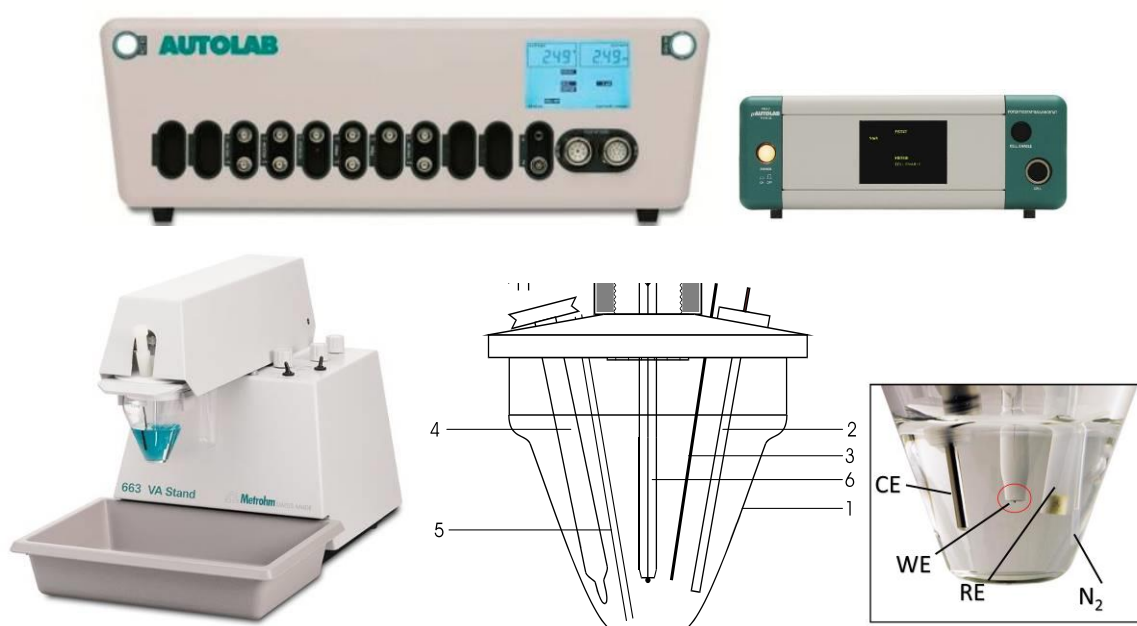

Figure 3.13. Top row: PGSTAT 128N and $\mu\text{Autolab3}$ instruments. Bottom row: Metrohm VA 663 electrode system and 3-electrode cell compartment: 1 – electroanalytical cell, 2 – reference electrode (RE), 3 – counter electrode (CE), 4 – Teflon rotating stirrer, 5 – Nitrogen tube (N_2), 6 – Working electrode (WE).

The electrode system is computer controlled by instruments, while all other operations (sample addition, standard additions, drop formation, stirring, etc.) are automatically controlled by a computer or external home-made programs.

In order to remove dissolved oxygen (interference in voltammetric measurements), the sample was initially purged with nitrogen for at least 5 minutes prior to measuring. Between separate measurements in the same sample, the purging time was 15-30 s. A nitrogen blanket was maintained over the sample during measurements. The speed of stirring was 3000 rpm.

Automated analysis. Trace metal analyses were performed using a fully automated system assembled in our laboratory consisting of: an instrument, a home-made sample changer, and Cavo syringe pumps (Fig 3.14). Samples were added to the electrochemical cell by the automated auto-sampler developed in our laboratory, whereas the addition of standards in the electrochemical cell was conducted by an automated dosing system (Cavo XE 1000 and XL 3000 syringe pumps, Tecan, Swiss).



Figure 3.14. Automated voltammetric system for trace metals analysis

Concentrations of trace metals were determined by means of the standard addition method. A certified “Seawater Reference Material for Trace Metals” – NASS-5 (NRC CNRC) was used to validate the analysis. All determined metal concentrations were within the certified limits.

The ESCDSOFT (ElectroChemical Data SOFTware) program developed in our laboratory (Omanović and Branica, 1998) was used for the treatment of voltammograms. When the automated analyses of trace metal concentrations were performed, a purpose-developed software (VoltAA) was used for data handling.

3.7.3. Voltammetric determination of Cu complexing capacity (CuCC)

For the determination of CuCC, the DPASV method was used. The experiments were performed using the same electrochemical system as described in the previous section (without using the sample changer). In order to diminish the adsorption of Cu into the walls of cell compartments, a Teflon cell was used. Before measuring, the pH of the samples was adjusted to a pH of 8.2 ± 0.1 , by adding a borate buffer (0.01 M), and checked, at the end of the experiment. The largest difference recorded was 0.1 units. Three automatic burette systems were used to automate Cu titration (Cavro XE 1000 or XL 3000 syringe pumps, Tecan, Swiss). The conditions used for the DPASV measurements of electro-labile Cu are presented in Table 3.7.

Table 3.7. Parameters for anodic stripping voltammetry used for CuCC measurement.

Parameters	DPASV
Deposition potential (V)	-0.45 or -0.50
Duration (s)	297
Desorption potential (V)	-1.4
Duration (s)	3
Equilibration time (s)	10
Modulation time (s)	0.05
Interval time (s)	0.1
Initial potential (V)	-0.5
End potential (V)	0.05
Step potential (V)	0.00195
Modulation amplitude (V)	0.040

20 ml of each sample was titrated with Cu, ranging from 300 to 500 nM of total Cu concentration ($[Cu]_T$) with 15 additions equally distributed in logarithmic scale, i.e. similar increments in $\log[Cu]_T$ (Garnier et al., 2004a; Louis et al., 2008). After each Cu addition, DPASV measurements were repeated each ~6 min (corresponding to the minimal time needed to perform an analysis) using the above-described procedure for 1.5 to 2 h. In that way ~15 voltammograms per addition were obtained; the last 2 were used for the construction of a complexometric titration curve.

Due to methodological/procedural specifications related to the CuCC measurement, a more detailed explanation about the applied procedure and data treatment are provided in the Results section.

3.7.4. Carbon analysis

A TOC-VCSH analyser (Shimadzu) was used to determine DOC and DIC concentrations. Calibration was done with hydrogenophthalate (Shimadzu) and $\text{NaHCO}_3/\text{Na}_2\text{CO}_3$ standard solutions, respectively, with an accuracy of 0.02 mgC L^{-1} (Louis et al., 2009; Oursel et al., 2013). A satisfactory accuracy of analyses was validated using certified reference material MISSIPPI-03 (Environment Canada).

The TOC-VCSH analyser coupled with an SSM-5000A module was used to determine POC on GFF filters. The filters were dried to a constant weight at 60°C , and exposed to HCl fumes for 4 h in order to remove all of the inorganic carbon (Lorrain et al., 2003). POC content was determined by the high-temperature (900°C) catalytic oxidation method with CO_2 IR detection, calibrated with glucose (Analytical reagent grade, Fisher Scientific), with an accuracy of 0.1 mgC .

3.7.5. Determination of effective diffusion coefficients for OP and RP DGT gels

The DGT diffusion coefficients needed to calculate DGT-labile metal concentrations, were supplied by the DGT device manufacturer (DGT Research), and experimentally obtained in 0.01 M NaNO_3 . This ionic strength is not representative of brackish/seawater (Garmo et al., 2003; Scally et al., 2006). Although the DGT-labile concentration is within “operational” value, due to the problems associated with the use of diffusion coefficients in solutions of different ionic strength (Scally et al., 2006), we decided to estimate an effective diffusion coefficient of trace metals using the “direct uptake” method (deployment of DGT devices in controlled conditions).

For this experiment, three 7 L bottles (the nominal volume of the PET drinking water bottle) were used. End members (10 L of freshwater and 10 L of seawater) were used to prepare working samples at three salinities. Water was first filtered under nitrogen pressure as was previously described and then exposed to UV light in order to decompose organic matter. Bottles were cut on the bottom and put upside down on a magnetic stirrer with a magnet in the cap of the bottle (Fig 3.15). In each bottle, 5 L of sample were added in the following way:

- 1) $S = 0$: 5 L of freshwater
- 2) $S = 19$: 2.5 L of freshwater and 2.5 L of seawater
- 3) $S = 38$: 5 L of seawater



Figure 3.15. Preparation of sample for DGT diffusive coefficient determination

The concentrations for each metal used in the study are listed in Table 3.8. Each concentration is selected to be at least 100× higher than ambient metal concentration. pH of samples was adjusted to be between 7.8 and 8.2 by addition of borate buffer. Under these conditions, model calculations using Visual MINTEQ 3.0 showed that precipitation of any metal is not likely to occur. Prepared samples were left overnight to stabilize under stirred conditions. Temperature of samples during the experiment was kept stable at 26 °C.

Table 3.8. Concentrations of metals (in nM) used for the determination of DGT diffusion coefficients

Metal	Final conc. (nM)
Cd	100
Pb	100
Cu	500
Zn	1000
Ni	500
Co	100

Five DGT samplers with open pores (OP), and five with restrictive pores (RP) were mounted on (previously cleaned) prepared plastic holders, and deployed in each of the stirred solutions for six hours. Before deployment, DGTs were rinsed by immersing the DGTs, mounted on holders, for a few seconds, in the corresponding washing solution (unspiked

with metals) with the same salinity as the working sample. Fig 3.16 presents the setup of DGT probes in holders and in measuring containers. Five mL of sample was taken from each of these bottles at the beginning, after fifteen minutes, after one hour, after two hours, after four hours, and after six hours. These samples were used to check the concentration of the added metals during the experiment. The temperature was controlled during sub-sample retrieval. After six hours, the DGTs were taken out, rinsed with MQ water, and the resin gels were retrieved as previously described.



Figure 3.16. Set up for DGT “diffusion coefficient” experiment

4. Results

CHAPTER I

“Evidencing the natural and anthropogenic processes controlling trace metals dynamic in the Krka River estuary”

4.1. Hydrological conditions of the Krka River

The Krka River flow (measured at the Skradinski Buk) for the period of January 2008 to December 2013 is presented in Fig. 4.1a. In addition, Fig. 4.1b shows the extracted flow for the period of our three sampling campaigns. Discharge of the Krka River is generally characterized by high variability, mainly related to weather conditions, i.e. rain periods/events. The calculated average flow for the 13-year period (2001-2013; data collected up to the time of writing) is $48.9 \text{ m}^3 \text{ s}^{-1}$, with a maximum of $327 \text{ m}^3 \text{ s}^{-1}$ and a minimum of $7.1 \text{ m}^3 \text{ s}^{-1}$. The inset graph representing the monthly average flows during this period, shows that the highest average flow was during winter ($80\text{-}90 \text{ m}^3 \text{ s}^{-1}$), whereas in summer, the average flow dropped to $<10 \text{ m}^3 \text{ s}^{-1}$. If compared to other years, a relatively low flow (never surpassing $100 \text{ m}^3 \text{ s}^{-1}$) was concluded to be a general characteristic of our sampling period (July 2011-July 2012; see red arrows in Fig. 4.1a). Thus, there is a possibility that some particular trace metal behaviours common for high discharges are omitted from our work.

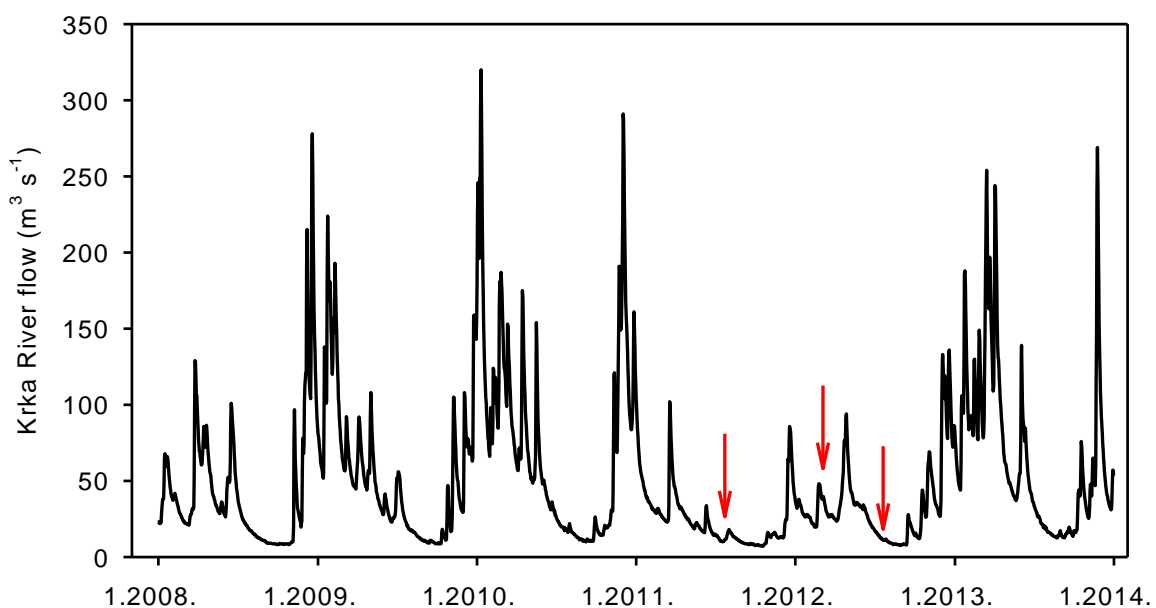

Figure 4.1a. Krka River flow from 2008 to 2013.

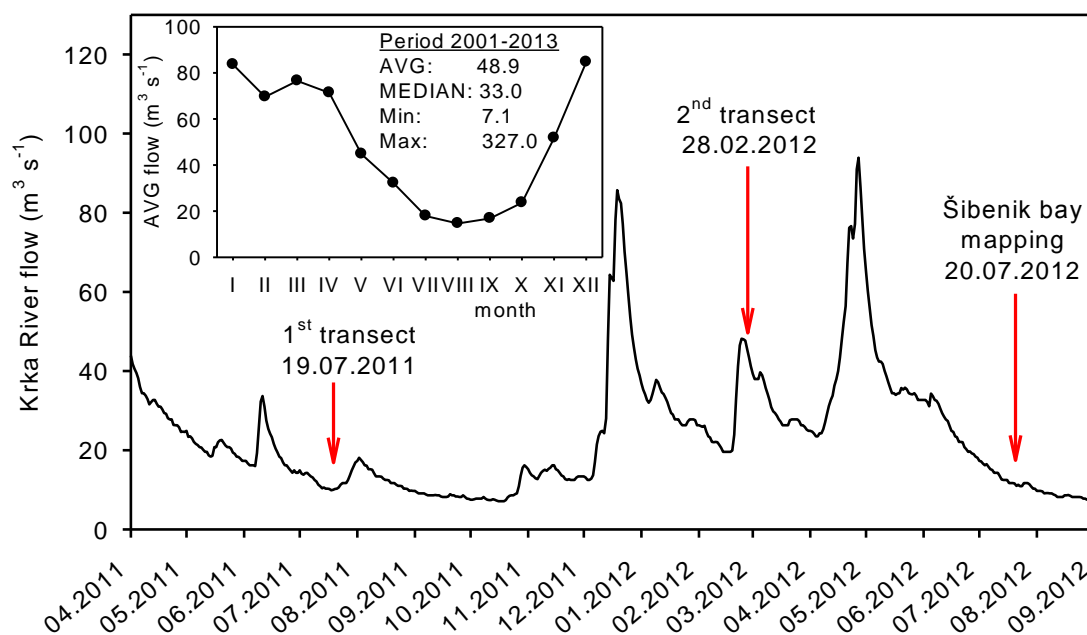

Figure 4.1b. Krka River flow covering the period of our sampling campaigns, with dates indicated by red arrows. Inset: average monthly flow of the Krka River for the period of 13 years (2001-2013).

4.2. Estuarine major physico-chemical parameters

4.2.1 Suspended particulate matter (SPM)

Fig. 4.2 (upper row) shows the distribution of SPM in relation to salinity and distance (from the head of the estuary) for the winter period. Although the level of SPM in the estuary is extremely low and consequently its measurement is susceptible to a relatively high level of uncertainty, well-separated trends for all three layers are evident. While the SPM in the surface layer is increasing seaward from $\sim 0.4 \text{ mgL}^{-1}$ to $\sim 3 \text{ mgL}^{-1}$, the level of SPM in the seawater is further increasing, but in the opposite, landward, direction (from $\sim 3 \text{ mgL}^{-1}$, up to $\sim 6 \text{ mgL}^{-1}$), as a consequence of the progressive enrichment in seawater because of its longer residence time (100 to 250 days, depending on the season (Legović, 1991c)). In the halocline, the SPM lies between these two trends, showing that the upward transport from the seawater layer is regulating the vertical profile of the SPM along the estuary, as projected by the above described transport model.

The flow of the Krka River during the winter campaign ($44 \text{ m}^3 \text{ s}^{-1}$) was below its average value for this period ($70 \text{ m}^3 \text{ s}^{-1}$) (Fig. 4.1b). Weak erosion of the karstic area, associated with the SPM removal at the waterfalls (Cukrov et al., 2008), caused an extremely low input of SPM by the river, providing proof of the peculiar biogeochemical processes affecting TM,

4. Results

organic carbon behaviour and fate, not overrode by the large SPM load usually encountered in classical estuaries. The less-defined relationships of SPM with salinity were obtained for the summer campaign (Fig. 4.2, lower row) probably due to the non-negligible contribution of biogenic particles to the overall SPM concentration. In relation to distance, two separate decreasing sections, split at the 15th km, could be perceived for each layer. Intensive mussel farming in this region, associated with the increased phytoplankton productivity (high O₂ saturation was observed in this region, see Fig. 3C) may serve as a possible source of SPM.

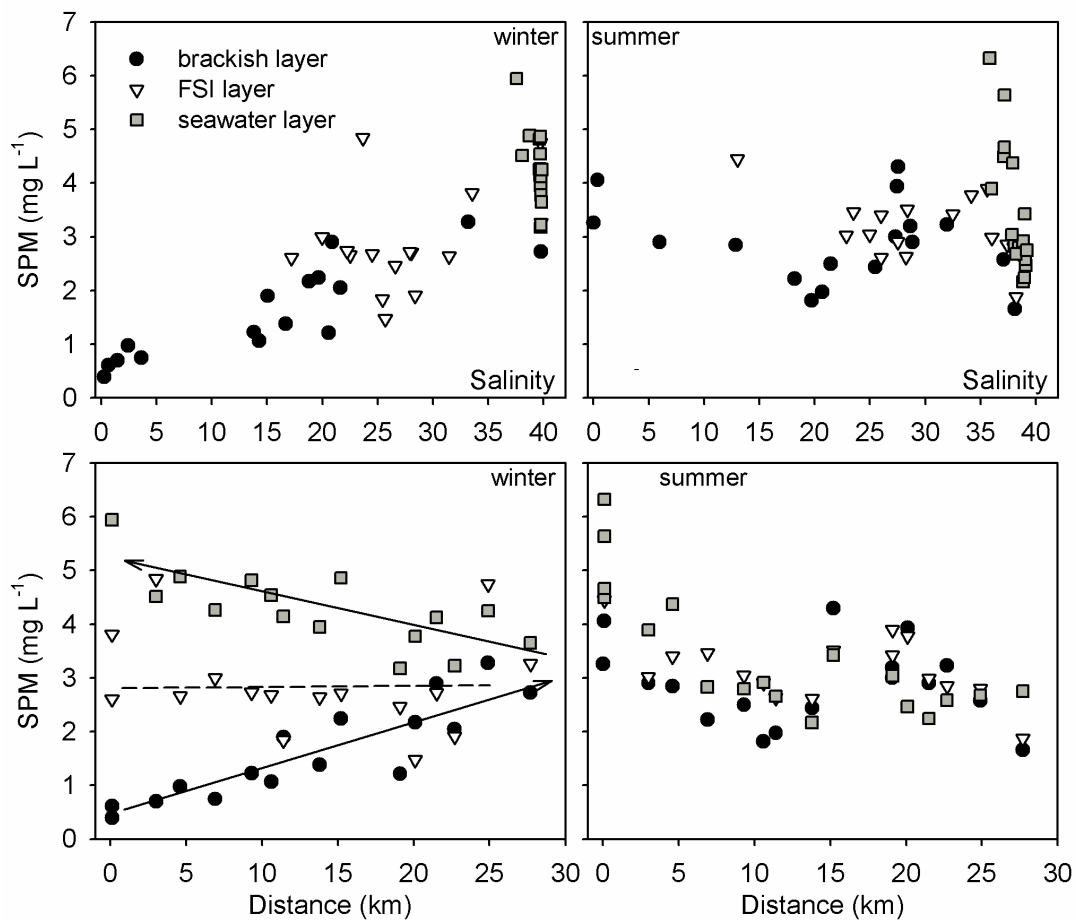

Figure 4.2. Distribution of SPM in relation to salinity and distance (from the head of the estuary) for the three layers, in winter and in summer. Arrows indicate the direction of water mass flow for the brackish and seawater layers.

4.2.2. Salinity, temperature and dissolved oxygen

Figs. 4.3A-C shows contour plot profiles of temperature, salinity and dissolved oxygen along the estuarine transect at fifteen sites recorded in the winter of 2012 and in the summer of 2011. As expected, in winter 2012, generally low temperatures and salinities were observed in the upper brackish layer due to the low atmospheric temperature. While the surface layer temperature was maintained between 5 and 7.5 °C along the 23 kilometer-long transect, an increase in salinity (up to twenty) was recorded for the same horizontal profile as a consequence of progressive freshwater and seawater mixing. The surface layer temperature and salinity reached sea-values only at the last sampling site (in the “open” sea), having a quasi-constant depth profile for both parameters. At all other sites, depth profiles showed well-defined salinity stratification of the water column. A clear segmentation of the three separate layers with a sharp halocline (FSI layer) encompassed the first half of the estuary. Maintained at a depth of between two and three meters, the thickness of the halocline (spanning an increasingly small salinity range) increased seaward and progressively (from ~0.4 to ~2 m).

In the summer 2011 campaign, although the temperature of Krka River was high (26°C), a slight increase in temperature at the surface layer (up to 28 °C) was observed for the approximately the first 10 kilometres due to solar irradiation, while more intensive mixing with colder seawater at more downstream sites led to a decrease in surface temperature (linear relationship with the salinity).

Depth profiles showed the occurrence of the temperature maxima in the FSI layer (halocline) in the upper estuary region and in the downstream estuary segment (the Šibenik bay) during the mapping campaign (July, 2012; data not shown). The occurrence and the intensity of the temperature maxima is regulated by a combination of atmospheric temperature (solar irradiation) and entrainment of seawater (mixing), and is periodic behaviour over the course of several days (Legović et al., 1991b) and also within one day (unpublished results).

Due to the low Krka River flow ($\sim 10 \text{ m}^3 \text{ s}^{-1}$, Fig. 4.1b) in the summer of 2011, a clear separation of the three layers with a strong salinity gradient in the halocline was maintained only for the first five kilometres. However, regardless of the period, it is clear that vertical salinity stratification is pronounced along the whole estuary transect, even if the depth of the halocline and its thickness varied. Our fifteen site profiles of salinity and temperature

4. Results

generally correspond with the results and predictions of previous studies performed at a few selected locations in the Krka River estuary (Legović, 1991; Legović et al., 1991b).

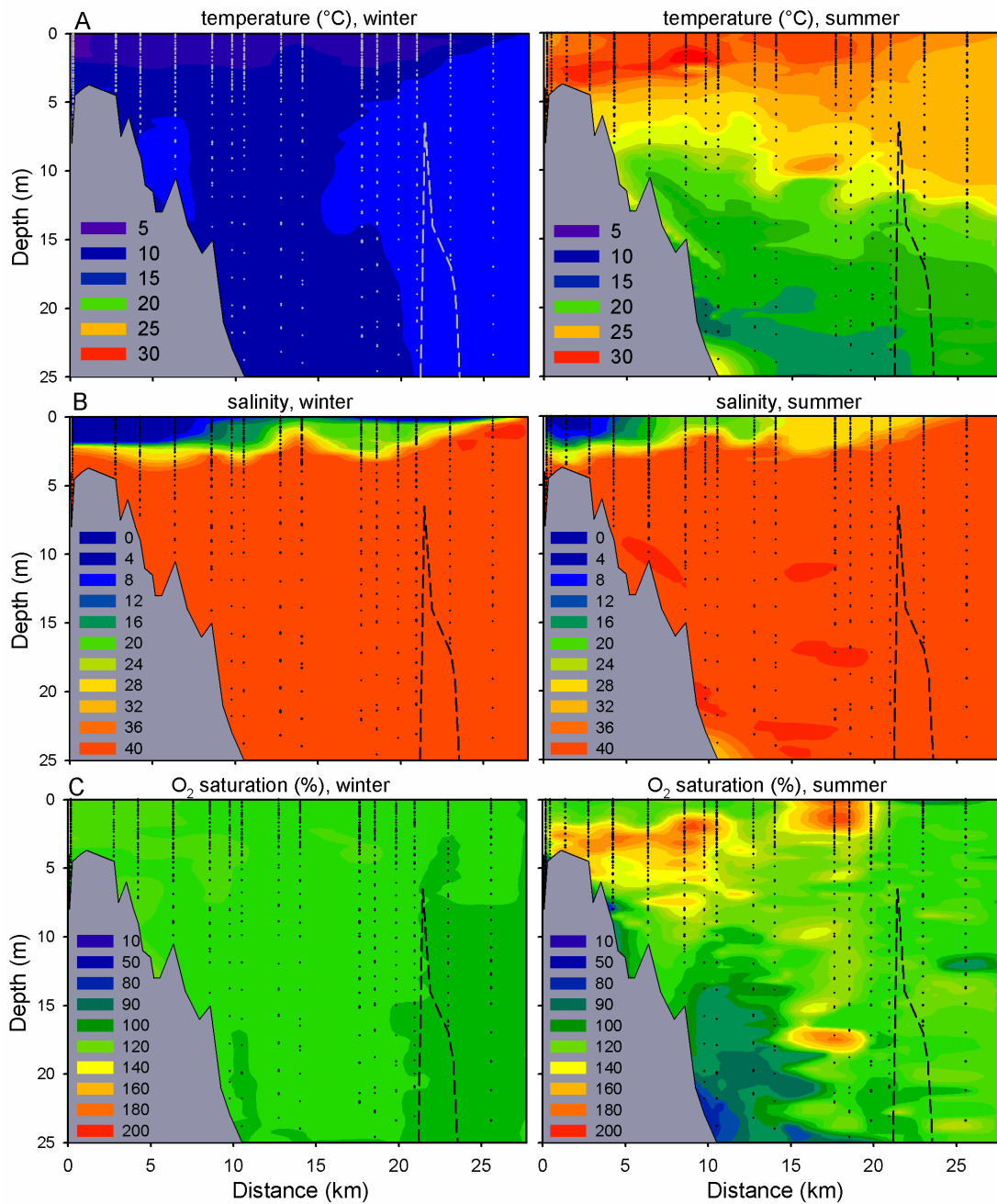

Figure 4.3. Two-dimensional distributions of temperature (A), salinity (B) and dissolved oxygen (C) in the Krka River estuary in winter 2012 and in summer 2011.

Relatively homogenous depth profiles of dissolved oxygen corresponding to 100-110% saturation were observed along the estuary in the winter period. However, oversaturation by oxygen (140-180%) at a depth just below the FSI (Fig. 4.3C) was registered in summer campaigns for the most upstream estuary segment and for the Šibenik bay as a result of the

high biological activities (Cetinić et al., 2006; Legović et al., 1991d; Legović et al., 1994). Namely, freshwater phytoplankton produced in the Visovac Lake (the Krka River) sinks and decomposes at a higher salinity, producing nutrients which favour blooms of marine phytoplankton at the lower edge of the halocline (Legović et al., 1991d). The observed temperature maxima additionally contributed to the high bloom development.

As a consequence of bloom decomposition, hypoxia in autumn in the Prokljan Lake was observed in previous studies (Legović et al., 1991c). Although in our case such hypoxia was not observed (as the campaign was conducted in summer), a clear decrease in oxygen saturation, down to 90% in the bottom seawater layer, was measured, which signifies a decreasing trend, potentially leading to hypoxia in autumn. However, as an isolated case, localized hypoxic conditions (<2% O₂ saturation) were found in summer in the bottom seawater layer at the uppermost site (KE-1). This site is characterized by a specific cuvette (bottom depth ~7.5 m, Fig. 4.3, right and 3C), in which the seawater residence time is longer compared to the adjacent seawater, enhancing the effect of bacterial mineralization of settled (and accumulated) biogenic material (e.g. lysed freshwater phytoplankton), which causes a decrease in oxygen. The effect of low oxygen at this location was found to influence the vertical distribution of trace metal concentrations, which is discussed later in the text.

4.2.3. Dissolved inorganic carbon (DIC) and pH

DIC. In karstic rivers, DIC is mainly derived from carbonate dissolution, which controls the water pH. The well-defined relationships between DIC and salinity (plotted with all three layers) for both the summer and winter period are presented in Fig. 4.4. If the relationship is examined, including freshwater and seawater end-members, the conservative behaviour is not apparent, even if a clear decreasing linear trend is obvious for salinities higher than ~5. An increase in the DIC value in the surface layer for both periods in the first few kilometres is likely due to the reestablishment of the carbonate equilibria, i.e. uptake of CO₂, which was previously degassed at the waterfalls. It is higher in winter than in summer due to the better solubility of CO₂ in colder water. The range of DIC values along the estuary/salinity gradient agrees well with the previous study (Cauwet, 1991), with the difference that in the previous study a linear relationship of DIC versus salinity was estimated, but no separation of DIC by season was examined.

4. Results

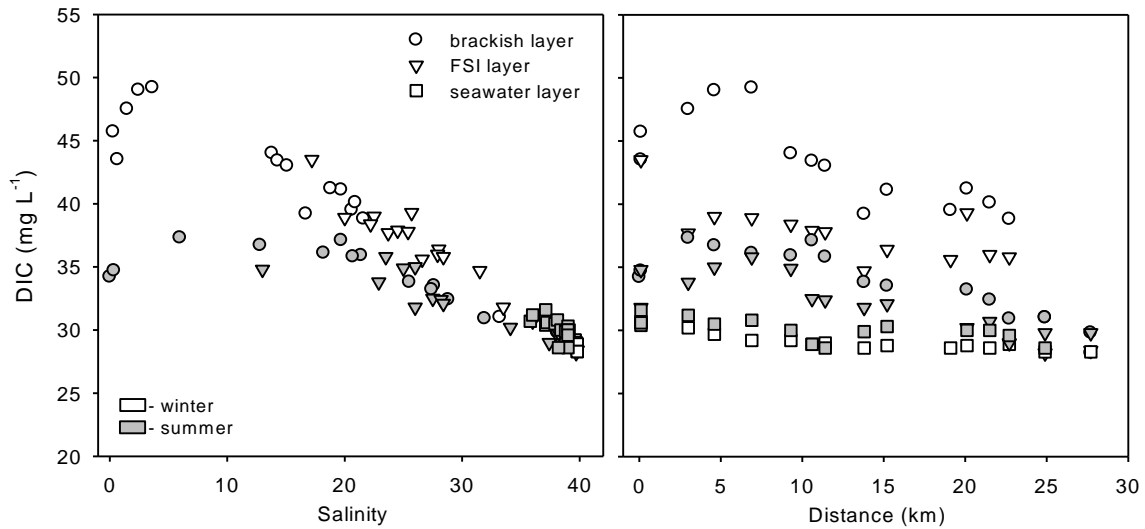

Figure 4.4. Distribution of dissolved inorganic carbon (DIC) in relation to salinity and distance for the three layers, in winter (white symbols) and summer period (grey symbols).

The pH measured in the estuary transect in both seasons ranged between 8.7 in the surface layer at the head of the estuary and 8.1 at the seawater end member (Fig. 4.5). Relatively high pH values (up to 8.5) were already recorded along the Krka River at locations after the waterfalls (Cukrov et al., 2008) as a consequence of the CO₂ removal (degassing) from the water (Vukosav et al., 2014). This is also the reason of the high pH value at the first site (KE-1) in the estuary, since its position is ~500 m downstream from the last and largest waterfall of the Krka River. As no clear relationship between pH and salinity was perceived, pH was plotted in relation to distance, where a few trends for each layer are distinguishable (Fig. 4.5).

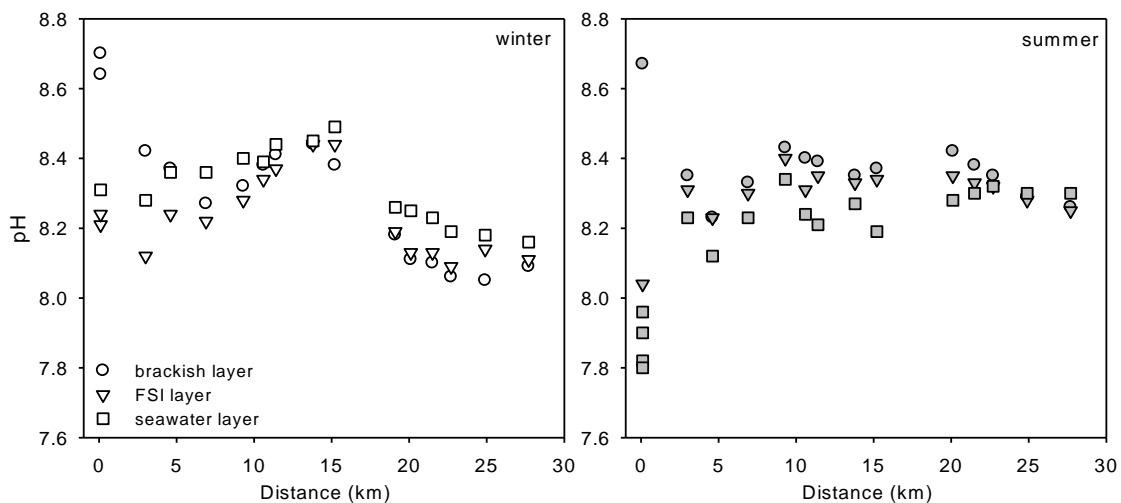

Figure 4.5. Spatial distribution of pH for the three layers in winter and summer period.

In winter, the decrease of pH in the surface layer at the beginning of the estuary (first ~6 km) is consistent with the DIC increase (Fig. 4.3), and could be a consequence of the partial acidification by the CO₂ uptake, as the buffering capacity of freshwater is not high. For the strong decrease in all three layers observed after the fifteenth kilometre, we do not currently have an explanation, i.e. it could not be unambiguously explained by the variation in any of the other measured parameters. Comparing the two periods, the winter period pH values in the surface layer were higher than in bottom seawater layer (with a few exceptions), while in the summer period, an opposite relation was observed. Aside from the above mentioned strong oxygen depletion in the cuvette, the mineralization of organic matter also led to evident drop of pH to 7.8. Longitudinal distribution of pH within the halocline lies generally between those of brackish and seawater layer, except in winter for the upper region (up to 15th km), where the lowest pH values were measured.

4.2.4. Dissolved and particulate organic carbon (DOC/POC)

DOC. Although previous studies reported that DOC concentration in the Krka River is relatively constant throughout the year (mean value of 1.18 mgC L⁻¹, (Cauwet, 1991), our measurements performed at contrasting periods clearly evidence a difference in DOC between winter (0.42 mgC L⁻¹) and summer (1.35 mgC L⁻¹). Compared to European rivers like the Rhine (~ 2.9 mgC L⁻¹), Loire (~3.9 mgC L⁻¹), Elbe (~ 4.6 mgC L⁻¹), Thames (~ 5.8 mgC L⁻¹) (Abril et al., 2002) or Gironde (~ 3.1 mgC L⁻¹) (Veyssy et al., 1998) concentrations of DOC measured in the Krka River are extremely low. Comparing the two end-members for the winter and summer period, lower DOC was measured in freshwater in winter (0.4 mgC L⁻¹ vs. 0.72 mgC L⁻¹) and higher in summer period (1.35 mgC L⁻¹ vs. 1.0 mgC L⁻¹). Higher DOC during summer period in freshwater part is the consequence of the enhanced biological activity in the Visovac Lake (freshwater part) (Petricioli et al., 1996; Svensen et al., 2007). Fig. 4.6 presents the distribution of DOC in a function of salinity for all three layers.

Although it is obvious that the linear relationship was not established for none of the sampling period, the non-conservative behaviour is more pronounced in the summer campaign. The range of DOC values and its distribution along the estuary is in agreement with studies performed more than 20 years earlier (Cauwet, 1991; Sempere and Cauwet, 1995), showing a persistency of the pristine/oligotrophic nature of the Krka River and its estuary. Contrary to our records, a conservative behaviour was found in various

4. Results

freshwater/seawater mixing zones such as the Huveaune and the Jarret Rivers plume (Oursel et al., 2013), the Rhône Estuary (Dai et al., 1995), the Mississippi River plume (Guo et al., 2009), the bay of Saint Louis (Cai et al., 2012), or the Humber Estuary (Alvarez-Salgado and Miller, 1998). However, due to the difference in nature (e.g. water residence time, estuary morphology, freshwater DOC concentration discharge), a direct comparison between these aquatic systems is not straightforward. More insight into the DOC distribution and behaviour in the estuary could be extracted if values for each layer would be plotted separately in relation to distance (Fig. 4.6).

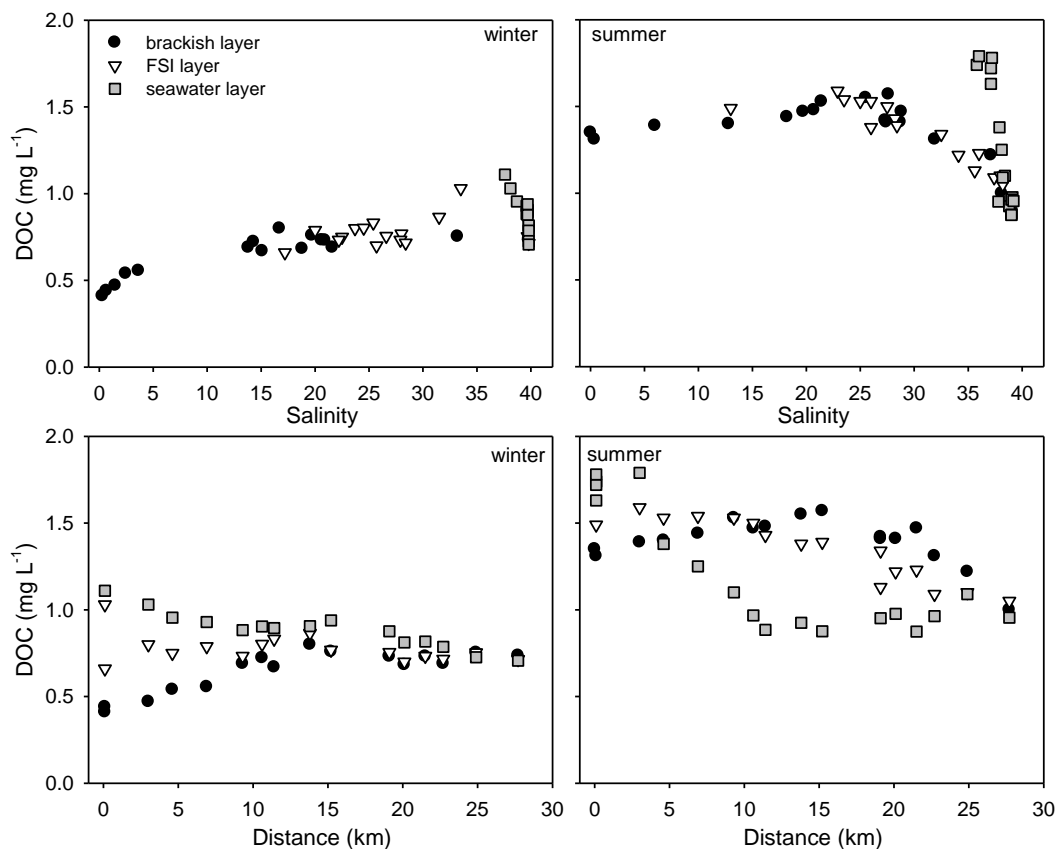

Figure 4.6. Distribution of dissolved organic carbon (DOC) in relation to salinity and distance for the three layers, during the winter and summer period.

For both seasons there is a linear increase (of about 0.35 mgC L^{-1}) of DOC in the surface layer up to about the 15th km. The increase could not be assigned to the external anthropogenic sources of Skradin town and its nautical marina (located at the 4th km, between sites KE-2 and KE-3), as the increase of DOC is not elevated after that region, and as the total increase is the same during the summer and the winter period, despite much higher nautical/touristic activity during the summer period. Mussel farming which is intensive in the estuary is also discarded as a possible source, since the majority (>90%) of

farms are located downstream of the 13th km (Fig. 3.1), and as it was found that mussel farming does not increase DOC (La Rosa et al., 2002). Detailed surface mapping of the Šibenik bay (Fig. 4.7) showed a slight change of DOC within the bay (Min/Max = 1.47/1.64 mgC L⁻¹, N = 36) suggesting no evidence of urban input from the town or harbour/nautical marina. Thus, biological processes (e.g. lysis of freshwater phytoplankton cells in seawater (Morris et al., 1978)) could be identified as the main sources of DOC within the first 15 km, while, although of small total amount, a partial desorption of organic carbon from the suspended particulate matter (SPM) could contribute.

At more downstream sites (>15 km), DOC maintained a quasi-constant level for all three layers in the winter period, whereas a linear (conservative) decrease was observed for the surface and the FSI layer in the summer period, as an result of dilution with seawater containing a lower DOC concentration. A landward increase of DOC in seawater (with a much more pronounced increase in summer compared to winter) is a clear consequence of the sinking of organic detritus decomposition from the surface layers, combined with the slow entrainment of seawater (residence time of seawater increases in the upstream direction). In the FSI layer (halocline), DOC exhibited variable trends for the summer and winter period, but generally spanned the range of values between the surface and the seawater layers.

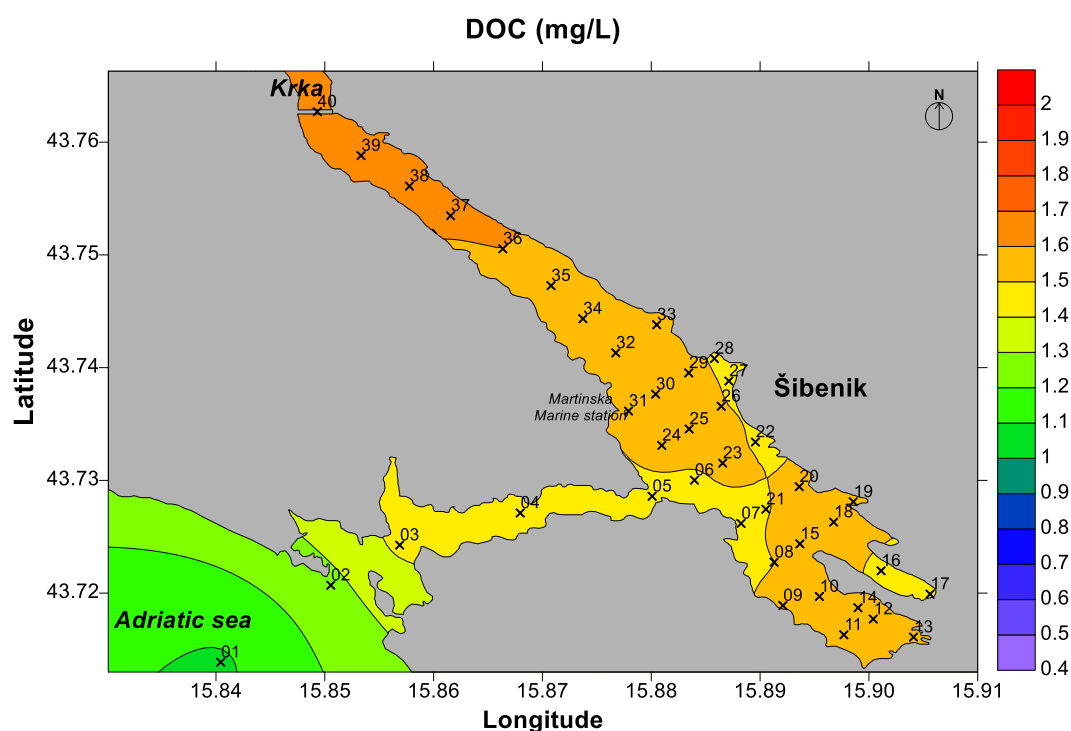

Figure 4.7. Distribution of dissolved organic carbon (DOC) in the surface layer of the Šibenik bay. Survey conducted in July, 2012.

4. Results

POC. By examining all samples along the estuary transect, a higher average POC value was obtained in the summer compared to the winter period (0.33 mg L^{-1} and 0.13 mg L^{-1} , respectively; Fig. 4.8). These values are extremely low if compared to other estuaries: the Scheldt estuary ($\sim 18.3 \text{ mgC L}^{-1}$), the Loire estuary ($\sim 6.3 \text{ mgC L}^{-1}$), the Gironde estuary ($\sim 2.6 \text{ mgC L}^{-1}$) or the Elbe estuary ($\sim 1.6 \text{ mgC L}^{-1}$) (all values from (Abril et al., 2002)). A general decreasing trend of POC with increasing distance were obtained for the winter and summer campaigns in all three layers (Fig. 4.8). However, while for the winter campaign a lower average value and a better expressed decreasing trend of POC in the surface layer was depicted, a higher average POC with more scattered values was observed in summer.

The increase of POC in winter halocline samples (compared to the other two layers) observed in the upper estuary segment could be explained by the accumulation of dead freshwater phytoplankton and possible flocculation of terrestrial particulate organic matter.

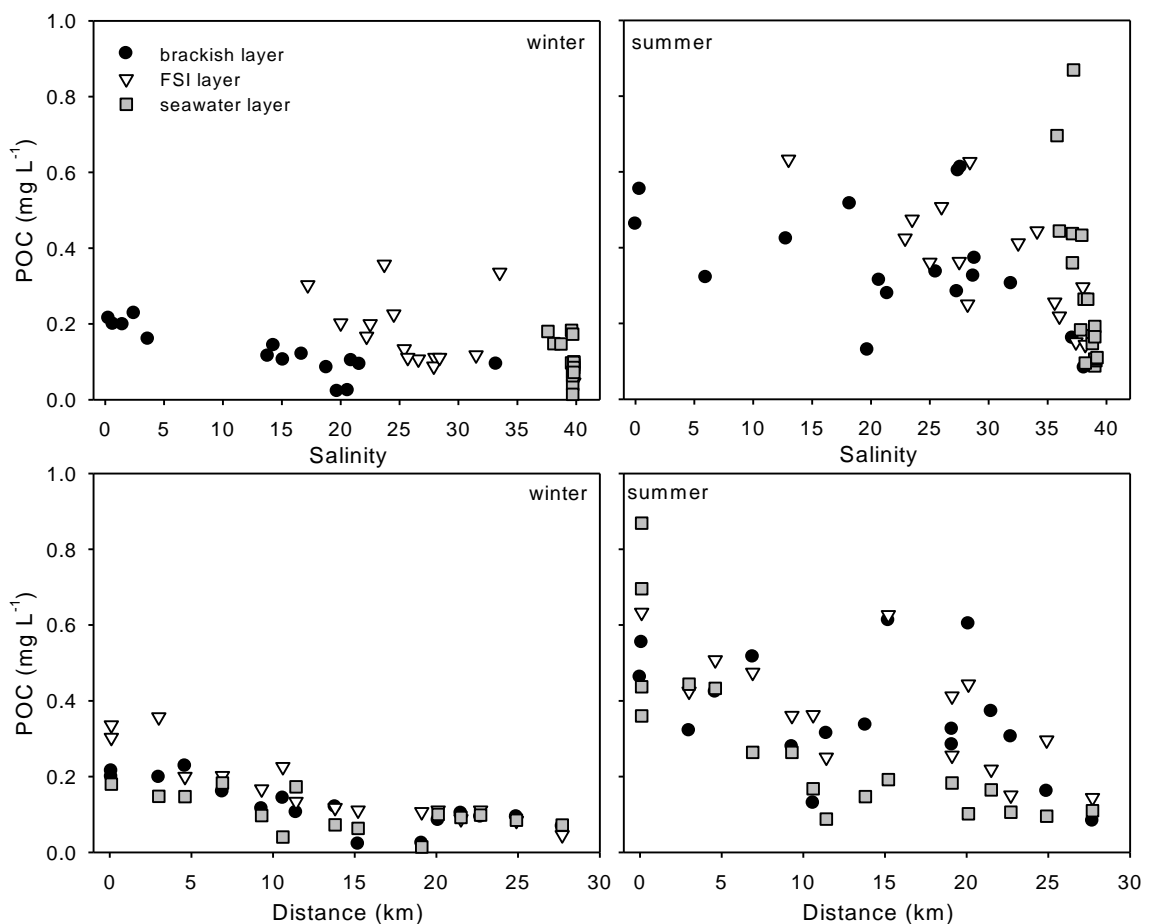

Figure 4.8. Distribution of particulate organic carbon (POC) concentration in relation to salinity and distance for the three layers, in winter and summer period.

When normalized on SPM, a well-defined decreasing trend of POC content, with separated segments for each layer in the winter period in relation to salinity, was obtained (Fig. 4.9). The content of the POC fraction decreased considerably in the surface layer at salinities up to ~15, following the conservative line. Contrarily, points at salinities higher than ~15 are below this line. The release of organic matter (OM) associated with SPM due to the competitive effect at increased salinities (considering the prevailing terrigenous, inorganic nature of SPM supplied by the Krka River) and/or the prevailing biogenic material in freshwater, could explain the observed POC content trend. In either case, the release of OM could not be reflected on the DOC concentration in the surface layer due to the relatively small total quantity of organic matter bound to SPM (surface layer). A slightly higher POC content in the FSI layer, than was predicted by the conservative line, could be explained by the accumulation of biogenic material (Cauwet, 1991; Sempere and Cauwet, 1995; Žutić and Legović, 1987). Almost no change was obtained for the seawater layer.

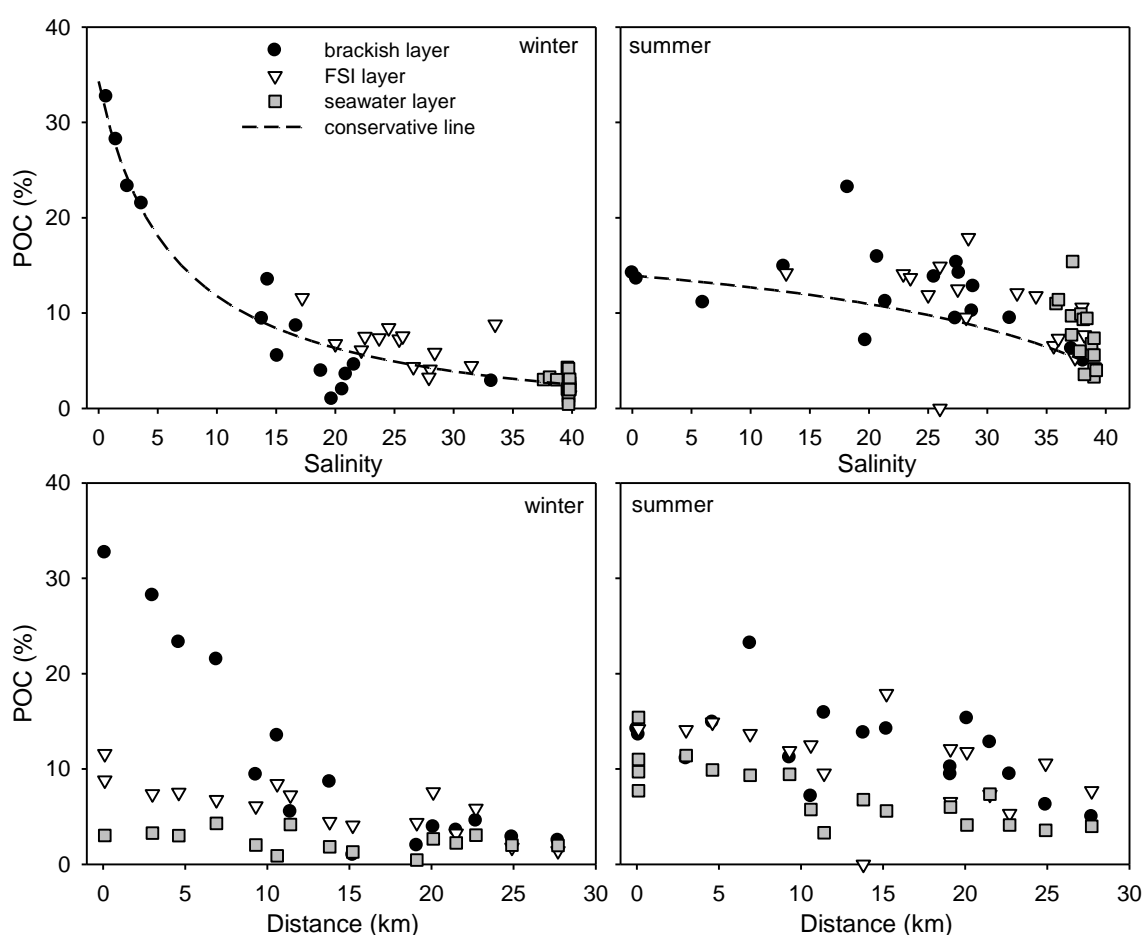

Figure 4.9. Distribution of particulate organic carbon (POC) content in relation to salinity and distance for the three layers, in the winter and summer periods.

In the summer period, higher POC concentrations were found in all layers as a result of the increased phytoplankton productivity. For all three layers, POC content is above the theoretical conservative line, which denotes a higher biogenic production of SPM. Although phytoplankton productivity in summer did not cause a strong increase of the average SPM, the organic fraction in particles from the FSI and the seawater layer was increased (compared to winter). A similar increase of the POC content as well as the concentration at the lower edge of the halocline, compared to the overlying and underlying water, was already registered in previous studies in the Krka River (Cauwet, 1991; Sempere and Cauwet, 1995).

4.3. Distribution of trace metals

4.3.1. End-members

There are only two publications up to now that report concentrations of trace metals in the freshwater end-member, the Krka River (Table 4.2). Our results confirm persistency of the Krka River's pristine nature over the period of more than 20 years, which is quite atypical. For our campaign, a surface sample at the first estuary point (KE-1/1, $S < 0.5$) showed systematically lower concentrations for all studied metals compared to sites upstream of waterfalls, and thus, this site was considered the end-member. The decrease in concentrations of trace metals is probably caused by their removal along the waterfalls preceding the estuary (46 m of total height) with 17 tufa barriers serving as traps (Cukrov et al., 2008a). In addition, the removal of metals is enhanced by the formed surface-active foam rich in organic matter and particles (Schilling and Zessner, 2011). Namely, due to higher biological activity in the upstream Visovac Lake during the summer season, water enriched with the surface active compounds favours the foam formation that accumulates metals (Schilling and Zessner, 2011; Zhang et al., 2009), similarly to that described for the sea-surface microlayer (Hunter, 1997; Truesdale et al., 2012). Compared to other Mediterranean rivers (Table 4.2), concentrations of trace metals in the Krka River are much lower (Dorten et al., 1991; Ollivier et al., 2011; Oursel et al., 2013).

For the seawater end-member (KE-15), there is no difference between winter and summer concentrations for Zn, Cd, Pb and Cu, while for Ni and Co, slightly higher values were measured in summer than in winter. Although this site is located within the coastal region, measured concentrations are very similar to those measured in the open parts of the Adriatic or the Mediterranean (Annibaldi et al., 2011; Tankere and Statham, 1996). This suggests that

the general contribution of metal inputs from the land to the sea is insufficient to cause a permanent increase of trace metal concentrations.

Table 4.1. Concentrations of trace metals in the Krka River (freshwater end-member), selected Mediterranean rivers, and the open Mediterranean Sea, as well as ranges (all depths) across the estuary transect sites for the winter and summer periods and in the Šibenik bay (high resolution mapping; summer), obtained in this study.

	Dissolved (total) metal concentrations (in nM)					
	Zn	Cd	Pb	Cu	Ni	Co
Elbaz-Poulichet et al. (1991) – Krka	-	0.044	0.08	1.78	2.47	-
Cukrov et al. (2006) – Krka	4.51 (4.63)	0.018 (0.025)	0.037 (0.166)	1.47 (2.52)	-	-
Krka – this study	3.25 (8.06)	0.015 (0.020)	0.03 (0.14)	4.44 (6.51)	2.09 (2.96)	0.31 (0.6)
KE1-1 (S<0.5)	2.03 (2.78)	0.008 (0.10)	0.02 (0.09)	2.45 (3.23)	1.86 (2.85)	0.24 (0.36)
KE-15 (S=38)	4.5 (5.2)	0.067 (0.069)	0.070 (0.101)	3.2 (3.6)	7.0 (7.45)	0.36 (0.36)
Range winter	2.0-14.9	0.02-0.16	0.01-0.22	1.76-7.29	1.76-7.29	0.20-0.66
Range summer	2.0-15.3	0.01-0.10	0.02-0.29	2.45-20.2	1.86-10.3	0.24-1.22
Šibenik bay	7.1-101.0	0.05-0.21	0.04-1.11	6.42-68.7	5.11-10.70	0.26-0.51
River						
Rhone ¹	41.3		0.33	32.7	16.7	
Huveaunne ²	52.0	0.07	0.64	27.0	43.0	6.9
Jarret ²	73.0	0.07	0.37	28.0	29.0	4.1
Po ³	57.7	0.58	0.72	25.7	-	-
Ebro ³	42	1.07	0.75	15.3	-	-
Arno ³	30.6	0.89	1.01	27.5	-	-
World average river ²	9.2	0.71	0.38	23	14	2.5
South. Adriatic ⁴	2.71	0.076	-	2.95	5.27	-
Central Adriatic ⁵	-	0.12	0.19	6.3	-	-
Mediterranean ⁴	2.7	0.062	-	1.7	2.4	-

¹(Ollivier et al., 2011), ²(Oursel et al., 2013), ³(Dorten et al., 1991), ⁴(Tankere and Statham, 1996), ⁵(Annibaldi et al., 2011)

4.3.2. Distribution of trace metals within the Šibenik bay

Among the potential point-source contamination locations, which could affect the distribution of trace metal concentrations in both a horizontal and vertical direction, the area of the Šibenik town (the Šibenik bay) was identified as the most critical. While previously the primary source of contaminants was waste water (WW) discharged within the bay, after the WW output was displaced (in 2007), activities in the harbour, nautical marina and mussel

4. Results

farming remained as the main threats. Thus, a detailed mapping of the Šibenik bay (40 sites, Fig. 3.1) was performed in order to identify locations and quantify contamination sources. Distributions of dissolved (filtered) and total (unfiltered) Zn, Cd, Pb, Cu, Ni and Co in surface layer are presented as contour plots in Figs. 4.10a and 4.10b.

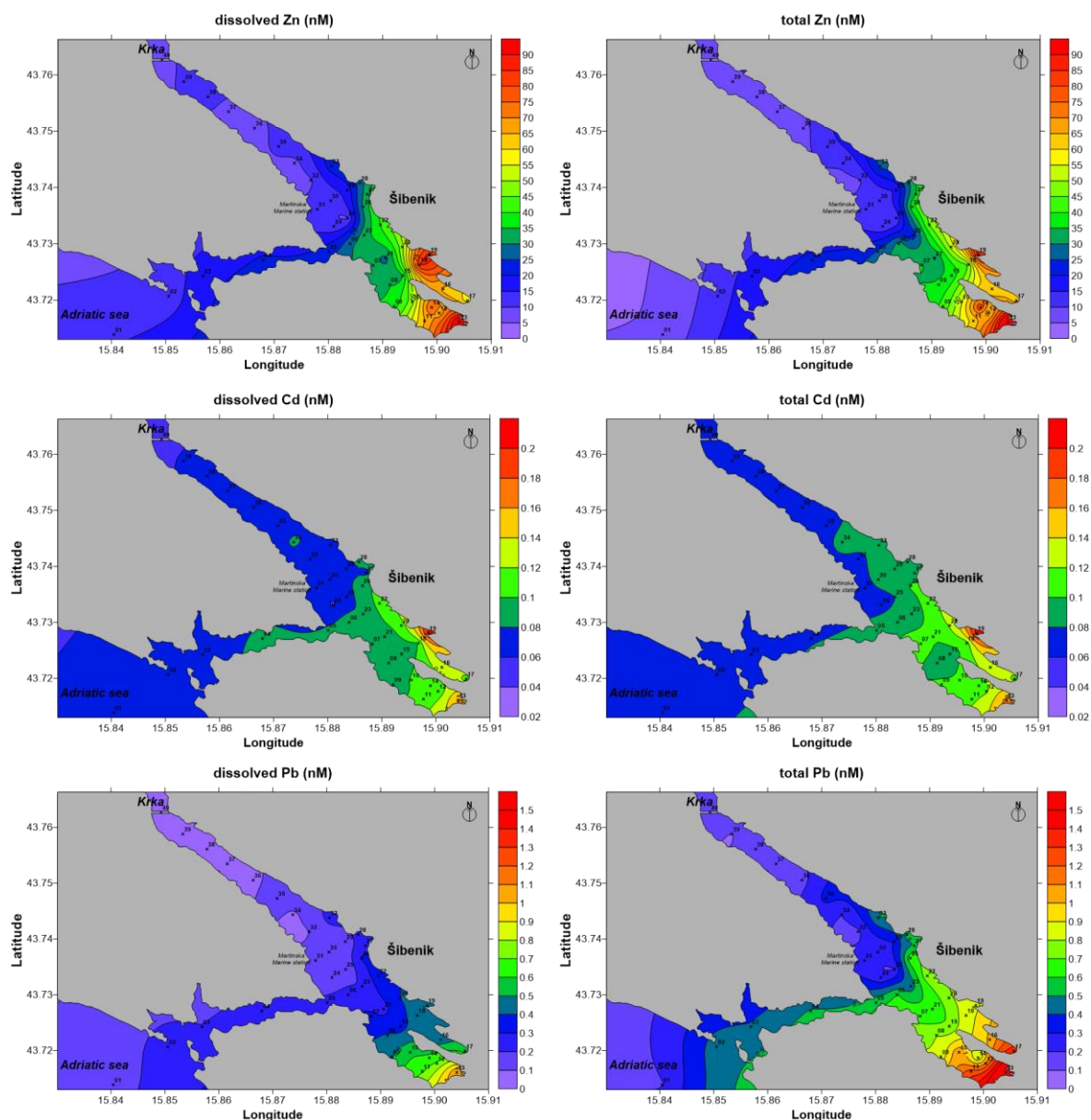

Figure 4.10a. Distribution of dissolved (left) and total (right) concentrations of Zn, Cd and Pb in the surface layer of the Šibenik bay. Mapping conducted in July 2012.

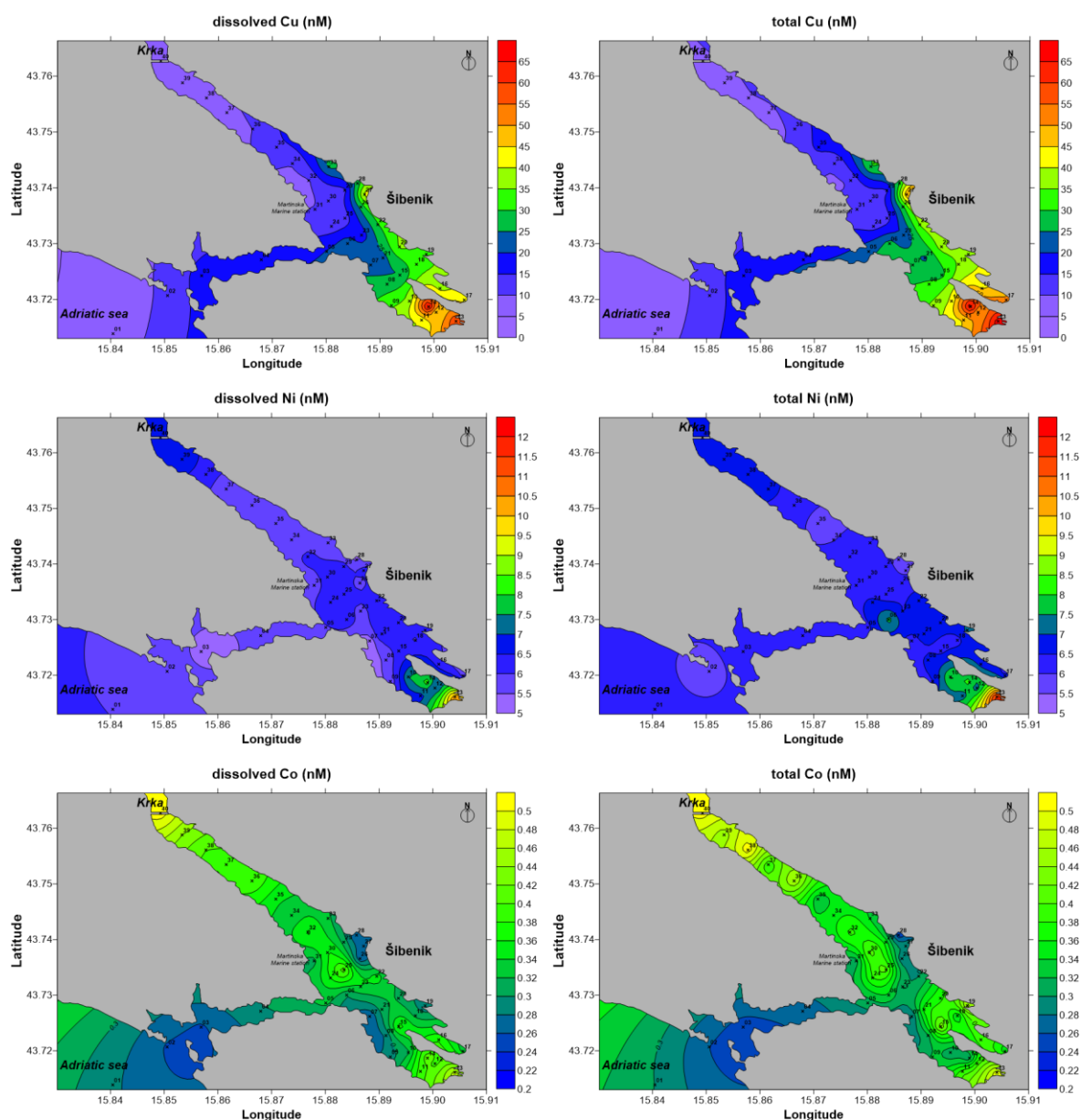

Figure 4.10b. Distribution of dissolved (left) and total (right) concentrations of Cu, Ni and Co in the surface layer of the Šibenik bay. Mapping conducted in July 2012.

As expected, the harbour and the nautical marina exhibited the highest concentrations for most of the metals. Compared to the low levels found within the bay (which are already high compared to the end-members) an increase of all metals occurred at particular locations. While increased Zn ($\sim 10\times$ compared to low levels within the bay; see Table 4.1: Šibenik bay) was found mainly in the nautical marina and harbour (with sharp concentration decline away from the source), an increase in Cu (up to $\sim 4\times$) concentrations were registered additionally along the Šibenik coastal line due to the numerous small boats. The location at the phosphate ore transshipment (unloading) showed the highest concentrations of Cd (up to

4. Results

~3×), while the location near the ship overhaul (in the marina area) was enriched with Pb (up to ~5×). Ni was found increased only at one isolated site (up to ~2×). No clear distribution/enhancement was observed for Co concentrations.

Despite “micro”-locations responsible for the highest observed concentrations separately for each metal, correlation coefficients higher than 0.8 obtained for Zn, Cd, Pb and Cu (Table 4.2), point to the same/similar sources considering the whole bay.

Table 4.2. Pearson’s correlation coefficients (level of significance 95%) between dissolved trace metal concentrations within the Šibenik bay (sites SB1-SB4 excluded from analysis as they are out of the Šibenik Bay)

Element	Zn	Cd	Pb	Cu	Ni	Co
Zn	1					
Cd	0.876	1				
Pb	0.928	0.895	1			
Cu	0.902	0.814	0.901	1		
Ni	0.577	0.536	0.647	0.568	1	
Co	0.059	-0.048	0.079	-0.022	0.569	1

A small but steady upstream increase of DOC ($\Delta = 0.15 \text{ mg L}^{-1}$) towards mussels farming locations was registered (Fig. 4.7). However, the increase should not be connected to the farming activity, as it was found that DOC is not increased in such areas (La Rosa et al., 2002). Overall, with the exception of Ni and Co, the detailed mapping revealed that the harbour and nautical marina could be considered the main sources of trace metals within the estuary. If compared to seawater/freshwater end-members, the following “enrichment” factors were obtained: 22/50 for Zn, 3/20 for Cd, 16/55 for Pb, 22/27 for Cu, 1.5/6 for Ni and 1.4/2 for Co. It is likely that the levels of contamination fluctuate depending on the activities within the harbour and the nautical marina, and thus, the measured values could be used only as merits of contamination sources and general levels when considering the distribution of metals for the overall estuary transect performed at different periods. One of the main questions is the space and time domain in which increased concentrations influence the trace metal distribution along the horizontal and vertical profile within the “whole” estuary. In this study, we focused only on the space domain.

The dynamic nature of the estuary, especially within the Šibenik bay, was additionally examined by measuring trace metals in the surface layer across the transversal transect

(direction: left>right of the estuary bank, 0.6 km distance). Fig. 4.11 shows the obtained results for the dissolved and total metal concentrations, as well as a corresponding profile of salinity. Much higher concentrations at the left (north) side of the estuary (closer to the Šibenik town) were measured, showing a non-homogenous structure of the surface layer.

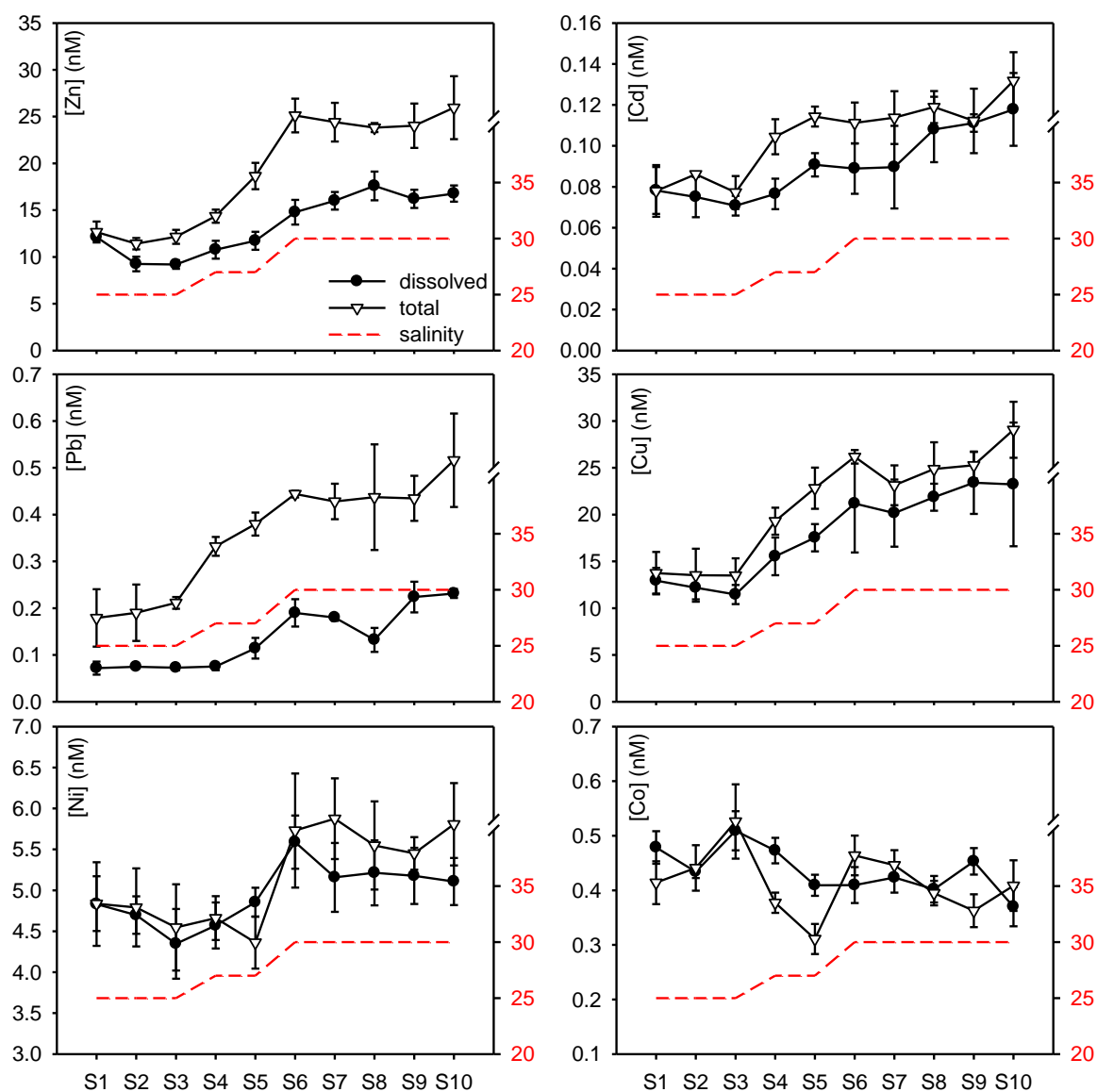

Figure 4.11. Distribution of dissolved and total trace metals in the surface layer along the transversal transect (left-right bank) of the estuary within the Šibenik Bay.

The observed distribution is mainly related to the hydrodynamics (movements of surface water masses) and the dilution effect. Knowing that point-sources of trace metals are located mainly on the side of Šibenik town, this distribution is not unexpected. The cleaner brackish water flowing more on the right side of the estuary, and the “polluted” water from the other

side, are, in a way, separated, which is clearly visible in the salinity profile. However, such a large difference in trace metal concentrations between two sides were not observed during high-resolution mapping (only 4 points), probably due to different hydrodynamic conditions at the time of sampling. This profile clearly demonstrates a scenario of highly variable conditions that occur within the estuary even at a very short distance (0.6 km). Thus, any interpretation of the variability of trace metals distribution within the estuary should take into account possible non-homogeneous distributions.

4.3.3. Distribution of trace metals along the salinity gradient

Fig. 4.12 summarises the distributions of dissolved concentrations of Zn, Cd, Pb, Cu, Ni and Co along the 15 measured sites in the Krka River estuary within three, vertically separated layers. A general observation for all metals is that the concentrations increase downstream in the surface brackish layer (Fig. 4.12, black circles), but also upstream-landward in the seawater layer (Fig. 4.12, grey squares). In most cases, the concentrations in the FSI layer for all metals were between those measured in the two adjacent layers (Fig. 4.12, triangles). Overall, the average trace metal concentrations in all three layers were higher in summer samples than in winter. This is particularly evident for Cu, for which $\sim 3\times$ higher average concentrations were found in the surface layer in summer, indicating additional input, primarily as a consequence of increased nautical activities (Omanović et al., 2006). Considering the vertical profile distributions, the average concentration of trace metals increases with depth, with the exception of Cu in summer. The highest difference along the vertical profile was observed for Pb, pointing to sediments as a potential source of Pb, along with its accumulation in the seawater layer.

A more detailed description and elaboration of the longitudinal and vertical profiles, as well as the behaviour/fate of trace metals is provided in the Discussion section.

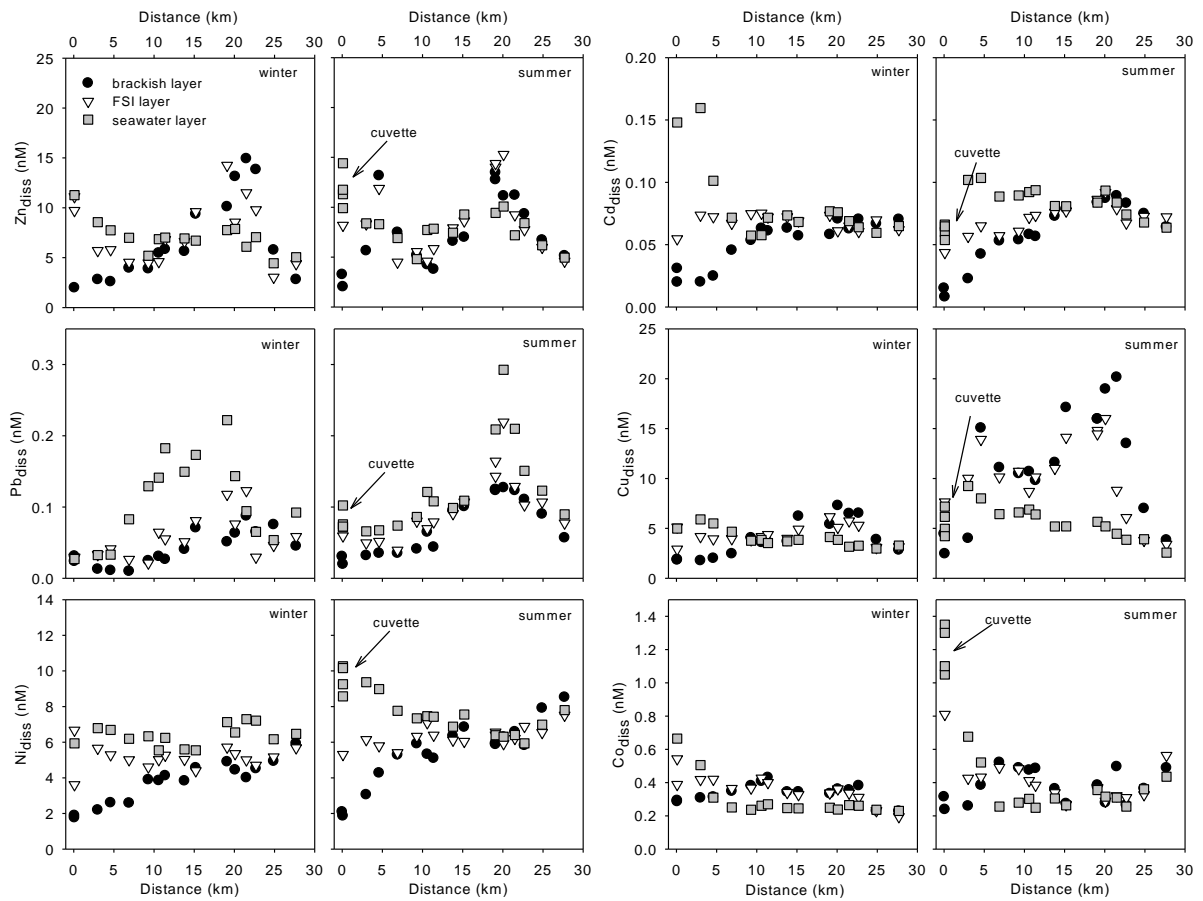

Figure 4.12. Distribution of dissolved trace metals in the brackish, FSI and seawater layers along the estuary transect in the winter and summer period.

CHAPTER II

“*In-situ* speciation of trace metals in a vertical salinity gradient of the Krka River estuary using Diffusive Gradient in Thin Films (DGT) technique”

In order to evaluate the Diffusive Gradients in Thin Films (DGT) technique for (operational) speciation of trace metals across the salinity gradient and additionally to assess its use as a potential methodology in estimating trace metal bioavailability/toxicity for regulatory monitoring purposes (as suggested by the Water Framework Directive, WFD, 2013), a site in front of the marine station Martinska was selected as a site representative of the whole estuary, exemplifying a relatively “clean” sub-region. The close vicinity of the site was beneficial to this study because it allowed a numerous (7-10 times/day), “high-frequency” measurements of physico-chemical parameters at the positions of DGT device deployments during the deployment period of ca. 5 days. A 5-day period was found as an optimal period, balancing in between a preferred longer deployment due to the low TM concentrations and capability of everyday discrete sampling by a diver, because in addition to DGT deployment, two (summer) or one (winter) discrete samples were collected by a diver at each DGT depth each day in order to prepare a composite sample (composed of 6 or 12 sub-samples). It was assumed that composite sample, in which the dissolved/total metal concentrations of trace metals and dissolved organic carbon (DOC) were measured, is representative for the deployment period.

An additional comparative site with increased concentrations of trace metals (representing the “polluted” site) was located within the nautical marina “Mandalina”.

4.4. Hydrographic conditions

An overview of the hydrographic conditions of the Krka River for the period of the DGT-deployment campaigns is presented in Fig. 4.13. A previous detailed study performed by Legović (1991) revealed that the salinity of the surface layer and the depth of the halocline along the estuary is greatly influenced by the Krka River flow. However, strong weather conditions (wind/rain) could have a large influence on both the surface salinity and the short-term change of the halocline depth. Our measurements confirm previous observations (inset

in Fig. 4.13). Among 5 separate DGT-campaigns, only one was conducted in the period of relatively high Krka River flow (winter, 2010).

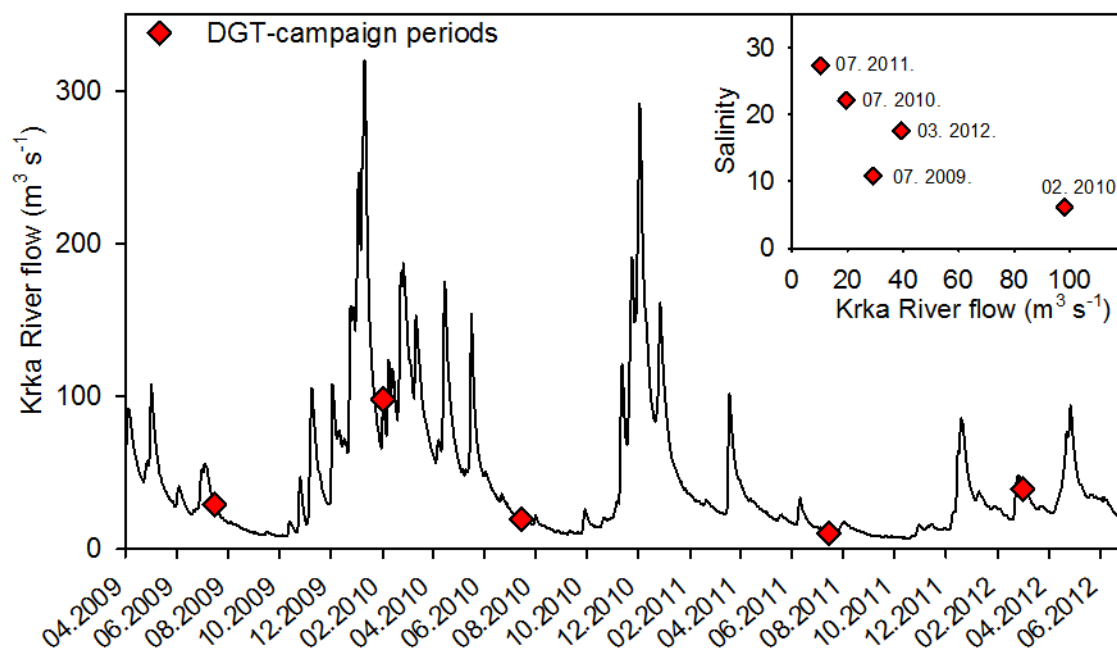

Figure 4.13. Krka River flow covering the period of our DGT-campaigns, with red diamonds indicating the dates of each separate campaign. Inset: dependence of the surface salinity on Krka River flow at the position of DGT-deployment (Martinska).

4.5. Major physico-chemical parameters during the deployment period

4.5.1. Salinity

As previously shown, the vertical profile of the water column along the Krka River estuary is characterised by pronounced salinity stratification with the halocline positioned at a depth of 2-3 m (Martinska site), which is dependent on the Krka River flow, and weather conditions (mainly wind). In Fig. 4.14, vertical profiles of average salinity (for each DGT-depth) at the DGT-deployment site (Martinska) for all five sampling events were plotted. For each campaign, a well-developed halocline at a depth of between 1.5 and 3 m was formed for all but the winter 2010 campaign, for which halocline was 1 meter deeper. Positions and thicknesses of the haloclines were in accordance with the Krka River flow before and at the time of the DGT-campaign. While the salinity was relatively stable in the surface and seawater layer during the deployment periods, the same could not be said for other depths. Fig. 4.15 clearly illustrates the two contrasting cases: while in the summer of 2009 the

4. Results

halocline was stable over the deployment time, a quite variable depth of halocline was registered in the winter of 2010. For that campaign, depths for the three deepest DGT positions were changed (moved up) in order to maintain the DGT-probes within the adequate range of salinity.

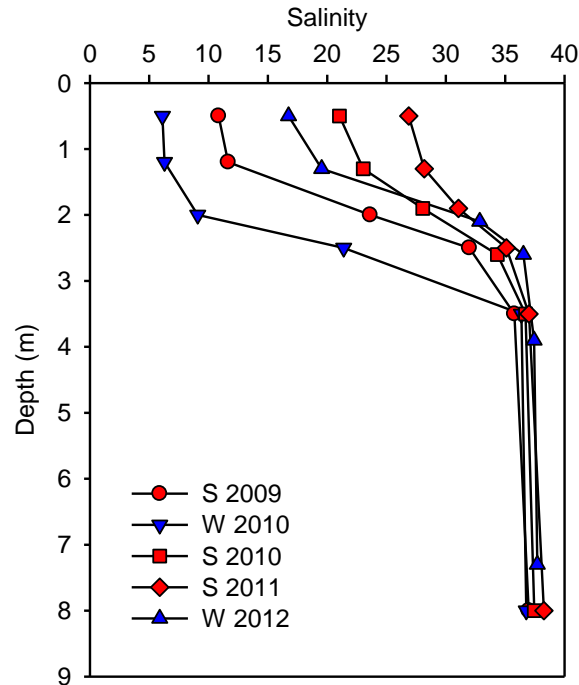

Figure 4.14. Vertical profiles of salinity at the positions of DGT-deployment depths (Martinska) for five DGT-campaigns. **Red** symbols correspond to the summer (S) and **blue** to the winter (W) period.

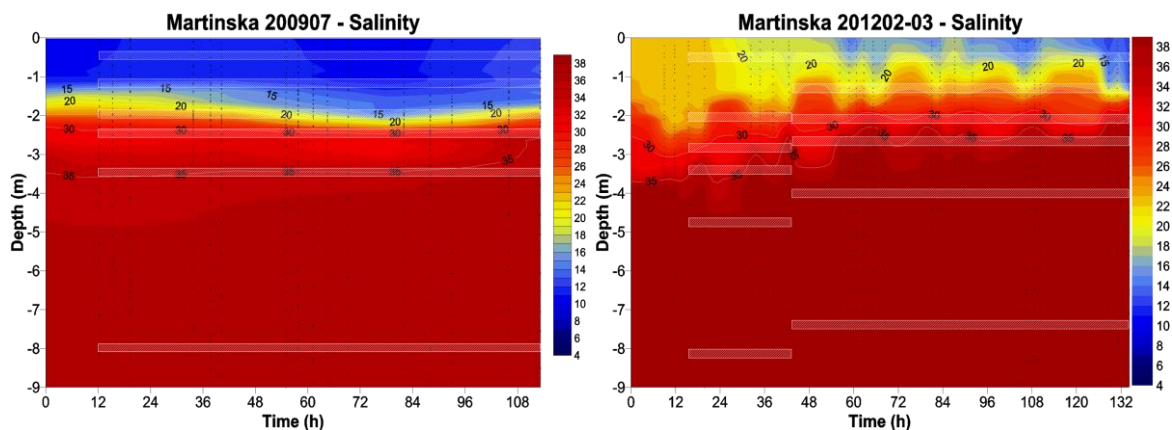

Figure 4.15. Examples of salinity variation during two DGT-campaigns: summer 2009 and winter 2012. The shaded areas represent DGT-deployment depths.

Salinities measured in the surface layer during the period of DGT-deployments (Fig.4.14) do not show a “typical” summer/winter pattern and exemplify contrasting conditions which

occur in the estuary. While salinity in the summer of 2009 was low, a relatively high salinity was measured in the winter of 2012.

In nautical marina “Mandalina” (Šibenik harbour, “polluted” site), the general trend of salinity changing with depth was in agreement with the one observed in front of marine station Martinska (the “clean” site). However, a much higher variability was observed on a day-to-day basis in the halocline region.

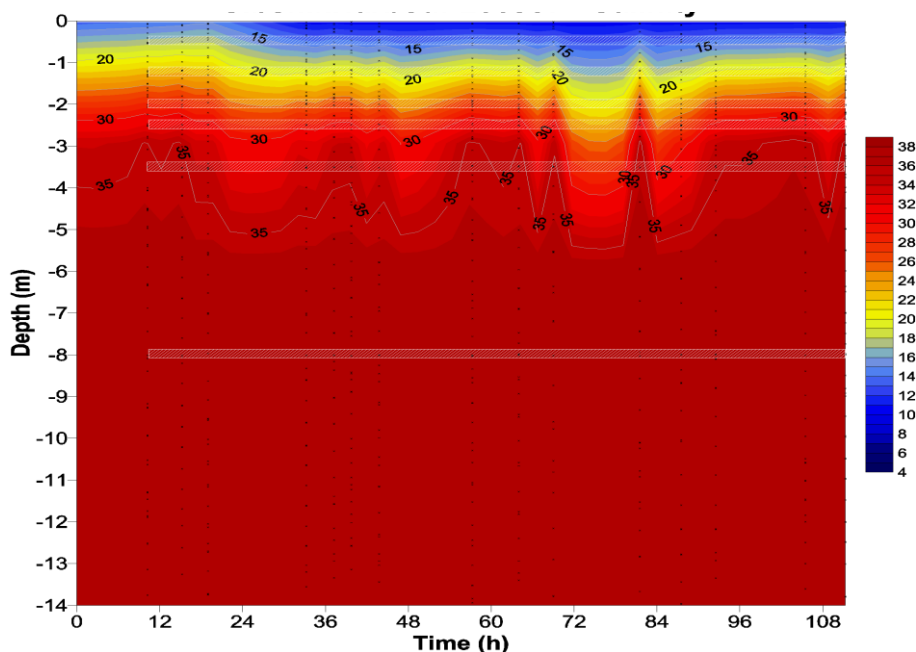

Figure 4.16. Salinity depth-time variation during the DGT-campaign in summer 2009 at the location of nautical marina “Mandalina”. The shaded areas represent DGT-deployment depths.

4.5.2. Temperature

One of the most important parameters for the DGT-technique is temperature. Indeed, the diffusion coefficient of trace metal species used in the calculations of DGT-labile concentrations is highly dependent on temperature. Fig. 4.17 shows vertical profiles of the average temperature at the Martinska site. As expected, a clear seasonal pattern of the temperature distribution within the vertical profile was recorded: a higher surface temperature in summer with thermocline, which agrees well with the depth of the halocline, and a temperature inversion in winter. Vertical profiles of the average temperature at the position of the “polluted” site in the nautical marina “Mandalina” agree well with those recorded at the “clean” site (Martinska). In addition, Fig. 4.18 shows two examples of

4. Results

temperature variations during the DGT-deployment period. While in the summer of 2011, the temperature was stable during the time of deployment, in the winter of 2012 a high variability (as was observed of salinity) was recorded.

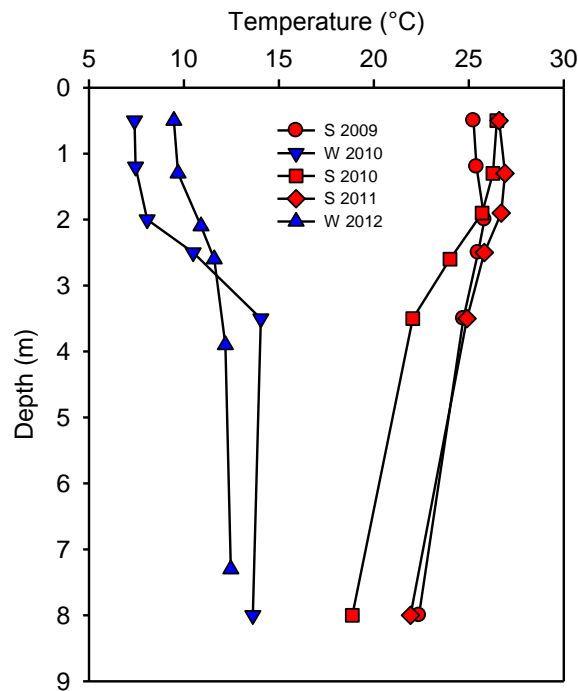

Figure 4.17. Vertical profiles of the average temperature at the position of the DGT-deployment site (Martinska) for five DGT-campaigns. **Red** symbols correspond to the summer (S) and **blue** to the winter (W) period.

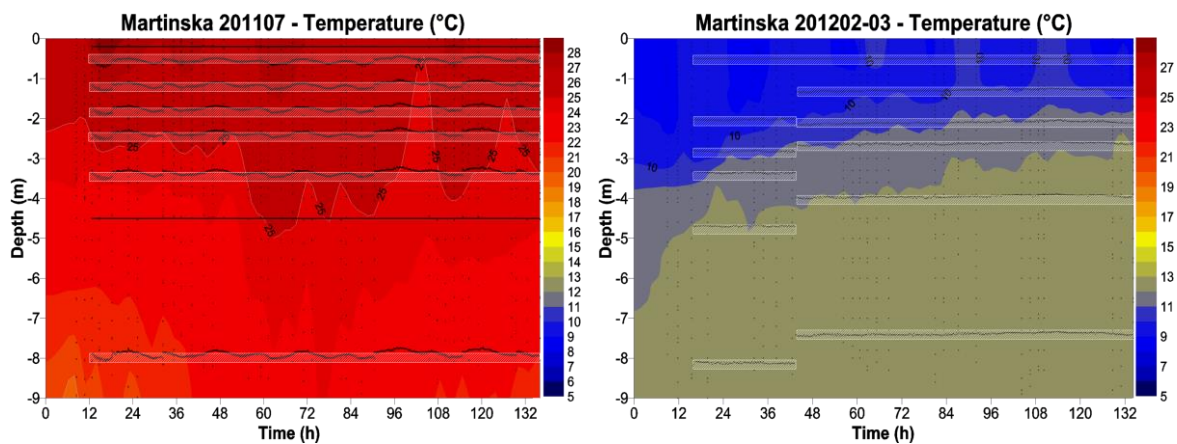

Figure 4.18. Examples of temperature variation during two DGT-campaigns: summer 2011 and winter 2012. The shaded areas represent the range of DGT-deployment depths, and the lines on the left plot represent the actual variations of the DGT-deployment depths.

However, as *in-situ* temperature/depth loggers were used to continuously monitoring temperature (every 15 min), it was assumed that the average diffusion coefficients (based on

the average temperature) were sufficient enough to “balance” the variation in actual diffusion coefficients of trace metals.

In addition to temperature, the left plot in Fig. 4.18 shows the variation of each DGT-depth during deployment time. Thanks to the “counter-weight” mechanism (described in the Experimental section), the absolute variation in depth was within 20 cm (the temperature/depth data loggers were installed at each DGT-depth). In that way, DGT probes were maintained at a quasi-constant depth (especially in the FSI layer, i.e. halocline) regardless of the tide, waves or wind influence.

4.5.3. Dissolved oxygen

Although dissolved oxygen by itself is not an important parameter for the calculation of DGT-labile metal concentrations, it provides a good overview of overall conditions (chemical and biological) within the water column, which could be of benefit while interpreting the observed DGT profiles. Generally, in the winter period, oxygen saturation was around 100-110%, while in the summer period, oversaturation (130-140%) was measured at the surface and FSI layer, indicating increased biological activities (Cetinić et al., 2006; Legović et al., 1994).

4.5.4 Dissolved organic carbon (DOC)

The DOC concentration in front of the Martinska station confirms the results of DOC measured along the Krka River estuary (Cindrić et al., 2015). This concentration is lower in winter (0.5-0.8 mgC L⁻¹) and higher in summer (1.0-1.4 mgC L⁻¹) in the upper layer (Fig. 4.19). The summer of 2009 showed behaviour similar to that in winter, due to the larger influence of freshwater. Higher summer concentrations of DOC at the interface layer are connected with enhanced biological activity.

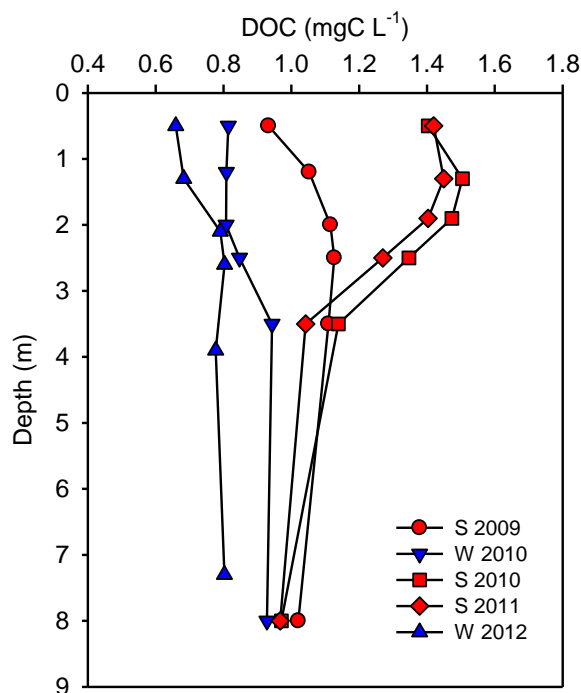

Figure 4.19. Vertical profiles of dissolved organic carbon (DOC) at the positions of DGT-deployment depths (Martinska) for five DGT-campaigns.

4.6. Determination of diffusion coefficients of metals

As it was previously mentioned, the DGT-technique provides an operationally defined measure of the DGT-labile (bioavailable) fraction so interferences can be made with respect to metal toxicity. It was assumed that DGT-labile concentrations represent the sum of the mainly inorganic fraction and the weak and kinetically-labile organic complexes of trace metals. Diffusion coefficients of metals, which are supplied by the DGT-Research company, are determined in a 0.1 M NaNO₃ solution at a pH of ~ 5 using diffusive cell methodology. Under these conditions, metals are present primarily as free aqua ions and inorganic species (mainly hydroxides and carbonates). Generally it was assumed that diffusion coefficients of different inorganic complexes are the same, however some metal-organic complexes have diffusion coefficients much lower than inorganic species (Zhang and Davison, 2001). Consequently, DGT-labile concentrations of trace metals measured in real experiments correspond to the **equivalents** of inorganic species, and thus are considered operational values, meaning “technique/condition-dependent”.

The two types of diffusion gels (open and restricted pore) used in our work differ in pore size. According to theory and expectations, these two types “see” different fractions of metal species. Concentrations of DGT-labile metals determined by restricted pore DGT should be

lower than those determined by open pore DGT probes. This is due to the fact that larger molecules (e.g. organic complexes) could/should not pass through the small pores (~1-2 nm). According to DGT-Research, diffusion coefficients determined for open pore DGT-probes should be multiplied by a unified factor of 0.7 if restricted pore DGT is used. In practice, several problems related to the use of the diffusion coefficient were identified while using the DGT technique (see Literature overview section). Accomplishing our first field DGT-study, we faced the problem that, for some cases (metals/depths), concentrations of DGT-labile metals determined by open pore DGT were almost the same or smaller than the corresponding ones determined by restricted pore DGT. Different “explanations” could be “developed” for such observations, however, before developing any “theories” as to the unusual behaviour, we wanted to re-measure the diffusion coefficients for both open and restricted pore DGT in real samples. In this way, the determined diffusion coefficients are called “effective diffusion coefficients” (D_{eff}). Any additional influence of the sample composition (e.g. ionic strength, inorganic speciation change) or even mechanical/structural imperfections on the production of DGT-devices are therefore “expressed” via D_{eff} .

For each metal of interest, effective diffusion coefficients were experimentally determined (the detailed protocol is described in the Experimental section) for all three water layers: brackish ($S < 2$), FSI layer ($S = 19$) and seawater ($S = 38$). Experimentally estimated D_{eff} values for Zn, Cd, Pb, Cu, Ni, Co, Mn and U are presented in Table 4.3. A slightly lower pH of working samples (UV digested, buffered and spiked with all metals at high concentration) adjusted to 7.9 ± 0.15 was not expected to change inorganic speciation of metals to the extent of influencing the diffusion coefficients estimates. All samples were kept at a temperature of 25.5 ± 0.3 °C. Small variations during the 6h experiment were assumed to have only a small influence on the final result.

Based on the “official” diffusion coefficients, during the 6h deployment period, the calculated decrease in metal concentrations (due to the continuous uptake by DGT devices; 10 pcs in total in each bottle) was expected to be below 5%. Seven separate samples from each bottle were taken at defined periods of time in order to monitor possible decreases in metal concentrations due to the continuous uptake. The concentrations of metals in these samples analysed by HR-ICPMS were within 5% of the expected concentrations (recovery was $100 \pm 5\%$), i.e. on the level of prepared/spiked (see Table 3.8). No obvious decreasing trend for any studied metal with the deployment time was observed. Thus, prepared/spiked concentrations were used to calculate the diffusion coefficients.

4. Results

One of the important parameters in DGT technique calculations is the “diffusive boundary layer” (DBL). This corresponds to the diffusion layer positioned on the side of the solution (outside of the probe) that is dependent on hydrodynamic conditions, i.e. on the strength of the stirring/mixing. In calm waters, such as lakes or seawater, DBL could significantly influence the calculated concentrations. Although our measurements were performed in seawater, due to the wind and waves, the DGT-holders were constantly moving left to right, eliminating in this way stationary conditions not appropriate for DGT (formation of a “large” DBL). As described in the Experimental section, five (5) DGT devices were positioned in two columns (3+2) facing each other (both for OP and RP). Mixing of the solution was controlled by a magnetic Teflon bar stirrer at the bottom of the bottle (see Fig. 3.15 in the Experimental section). In this way, a slightly different mixing strength was established along the vertical profile within the bottle, which allowed us to check whether the influence of a different DBL was possible to determine in real conditions. Based on 30 separate results (15 OP and 15 RP), no clear difference was found between DGT devices positioned at the surface and those positioned deeper in the bottle. Thus, it was concluded that under experimental conditions, the stirring strength did not have a noticeable influence on the DBL. Based on this artificial experiment, it was decided that DBL will not be considered as a factor (zero value assigned) in calculations of DGT-labile metal concentrations in real experiments. In addition, although DBL exists in all DGT-experiments, in our calculations it is “included” via effective diffusion coefficients (D_{eff}).

The experimentally determined average of D_{eff} (five replicates) for open pore and restricted pore DGT, is presented in Fig. 4.20. In addition, Table 4.3 lists some values of characteristic parameters and extracted results compared with published values. Average values for D_{eff} for examined trace metals (with the exception of Cu) and for both diffusive gel types, do not show any systematic trends (increasing or decreasing) in regards to the chemical composition of water (SW, MIX and FW). Thus, it is assumed that under the given conditions of the solution compositions, the change in inorganic speciation of trace metals does not have a measurable influence on the diffusion coefficients. The only systematic decrease obtained was for Cu. As this trend was not expected, and as currently there is no reasonable explanation, we decided to avoid the use of D_{eff} for Cu in our calculations, and instead, we used the value provided by DGT-research with the 0.7 R -factor applied for RP. An additional reason to not use the experimentally derived value for Cu is that the conversion factor between OP and RP diffusion coefficients for Cu was 0.5, which is rather too low.

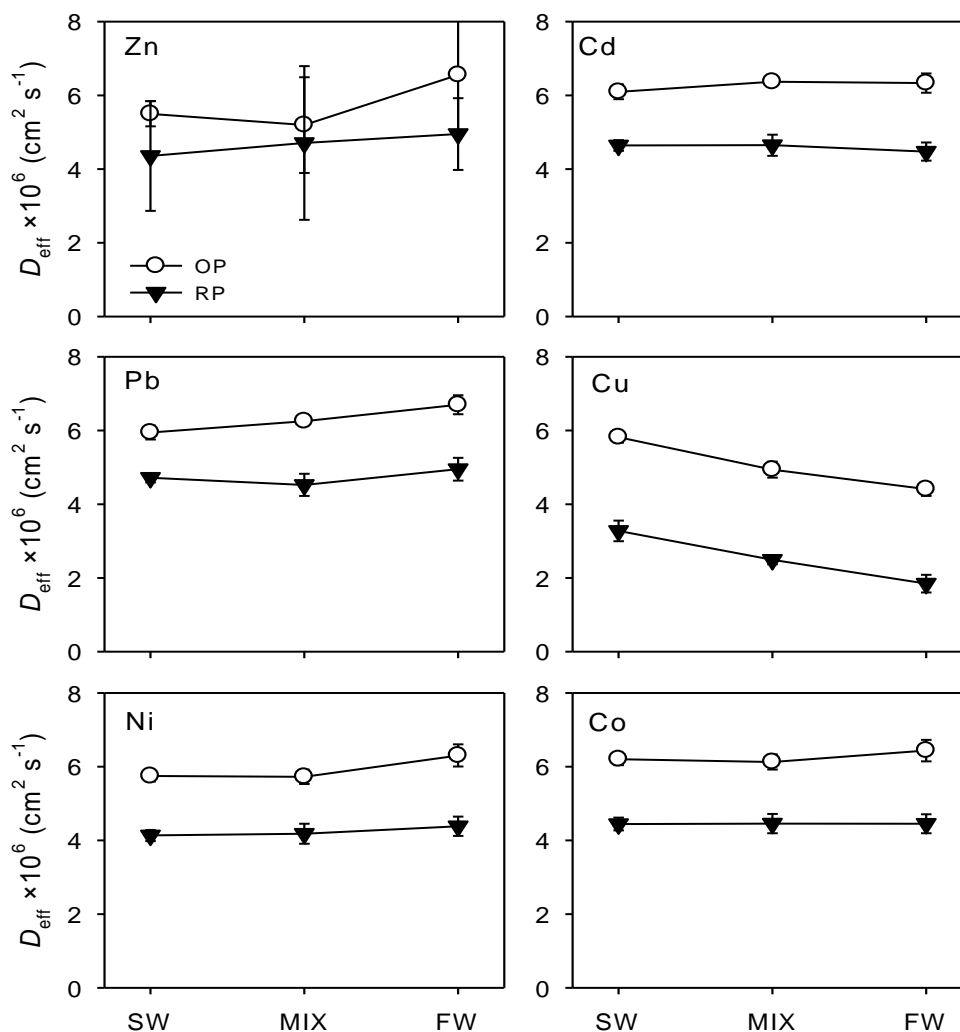

Figure 4.20. Effective diffusion coefficients for trace metals for open pore (OP) and restricted pore (RP) diffusive gels and as determined in samples of different composition of major ions: seawater (SW), mixed seawater-freshwater (MIX) and freshwater (FW) at an average temperature of 25.5 ± 0.3 °C under stirred conditions

Table 4.3. Concentrations of metals used in experiment, average percentage of DGT-blank (non-exposed probes), determined effective diffusion coefficients ($D_{\text{eff}} / \text{cm}^2 \text{ s}^{-1}$), “official” diffusion coefficient recommended by DGT-Research Company ($D_{\text{DGT-Research}}$), difference between the two values and average factor of the diffusion coefficient conversion for restricted pore gels (*R*-factor).

	Cd	Pb	Cu	Zn	Ni	Co
conc. (nM)	100	100	500	1000	500	100
% blank	0.1	0.3	2.2	34	0.1	0.4
$^a D_{\text{eff}} \times 10^6$	6.18	6.22	5.77	5.68	5.84	6.17
$^a D_{\text{DGT-Res}} \times 10^6$	6.09	8.03	6.23	6.08	5.77	5.94
% difference	1.4	-23	-7.4	-6.5	1.1	3.8
AVG <i>R</i> -factor	0.73 ± 0.04	0.75 ± 0.05	0.5 ± 0.05	0.82 ± 0.32	0.71 ± 0.05	0.71 ± 0.04

^a – diffusion coefficients @ T = 25 °C

Results obtained for Zn showed a strong influence of high DGT-blank concentrations (non-exposed DGT). Although a fairly high concentration of Zn (1 μM) was used in the experiment, the average DGT-blank concentration was higher than 30% (blank was 26% for OP, and 42% for RP). Consequently, high standard deviations were obtained, leading to uncertain values of D_{eff} for Zn. Although the difference between our D_{eff} and the “official” value is not large (-6 %), due to the high and uncertain value of the R -factor (0.82 ± 0.32) we decided to use the “official” diffusion coefficient in calculations (as in the case of Cu).

Generally a very good agreement between the effective diffusion coefficients and the published (official) data was obtained for most metals. The “exception” was Pb for which D_{eff} was 22% underestimated. Contrarily, Garmo et al. (2003) obtained around 20% higher values in their experiment. The difference between the experimental setup and solution composition (pH 4.7- 6 and 0.01 M NaNO_3 in the case of Garmo et al.) may be one of the reasons for such contrasted values. As different values of diffusion coefficients “operate” in literature, we decided to use the values obtained in our experiment.

Taking into account uncertainty, estimated R -factors (correction of diffusion coefficients for RP DGT) for all metals (with the exception of Cu) agreed with the recommended value of 0.7 provided by the DGT-Research Company. No systematic trend in the R -factor was observed in relation to the three types of samples, and thus, average values were calculated and assigned as “true” ones for further calculations.

4.7. Vertical distributions of dissolved and DGT-labile concentrations of trace metals at Martinska (“clean”) site

As explained in the Experimental section, during the DGT deployment time (ca. 5 days) discrete samples were taken each day (once in winter and twice in summer – morning/afternoon) in order to build a composite sample representative of the time of DGT exposure. These samples were used to determine the dissolved and total metal concentrations (UV digested and acidified) as well as for the Cu speciation analysis using the electrochemical method - determination of Cu complexation parameters (described in Chapter III).

4.7.1. Zinc (Zn)

Vertical profiles of dissolved and DGT-labile concentrations of Zn for each sampling campaign are presented in Fig. 4.21. While all vertical profiles of dissolved Zn concentrations showed well-defined trends, only one acceptable profile (having low uncertainty) of DGT-labile Zn concentrations was obtained: in the summer of 2011. Although quite comparable vertical trends of DGT-labile and dissolved concentrations were obtained in the summer of 2009, results for this season are only “conditionally” acceptable because in the surface layer, DGT-labile concentrations of Zn (with a slightly higher uncertainty) exceed those of dissolved Zn. Other seasons showed very scattered vertical distributions (with high uncertainties), without the expected coherent vertical trends of OP and RP profiles. In most of these cases, concentrations of OP and/or RP DGT-labile surpassed those of dissolved Zn. Such results clearly indicate contamination issues (which were already discussed previously) and thus, hinder the appropriate assessment of operational chemical speciation of Zn based on the DGT technique. It should be pointed out that the contamination is related to the production of DGT-probes (gels, probably not sufficiently clean chemicals, or the production process) and not to our DGT handling. This conclusion is supported by the simple fact that Zn concentrations measured in DGT extracts (diluted 3 times) are more than 10 times higher than in discrete samples analysed for dissolved Zn, for which a well-defined trend, with low uncertainty, was obtained for all campaigns. Note that in both cases, the same chemicals (MQ water and acid) and the same “clean” protocol of handling was utilised. In addition, vertical profiles of dissolved and total (not plotted on graphs) Zn concentrations showed the same trends, confirming the absence of contamination issues in applied electrochemical methodology.

With the exception of the winter of 2012 in which higher concentrations were determined in the surface layer, for all other campaigns, the vertical profiles showed generally similar trends: an increase in concentration down to the FSI layer and then a decrease in the seawater layer. The concentration of Zn in the seawater layer was relatively uniform (8.5 ± 1.6 nM), while in the surface layer, almost double this difference was measured between two campaigns (6.3 nM in the winter of 2010 and 13.2 nM in the winter of 2012). Taking into account that both values correspond to the winter period, it could be concluded that the level of Zn is not seasonally dependent. The same conclusion was drawn for this region of estuary which is elaborated upon in more detail in the Discussion section regarding Chapter I. However, a different salinity in the surface layer could explain the observed results: a lower

4. Results

salinity was measured in the winter of 2010 ($S = 10.8$) than in the winter of 2012 ($S = 16.7$). As the concentration of Zn in Krka River is on the level of 2-3 nM (see table 4.1), a higher flow (lower salinity) caused lower Zn concentrations in the winter of 2010. This explanation is also supported by the low Zn concentration in the summer of 2009 (6.9 nM) which is also characterized by low salinity.

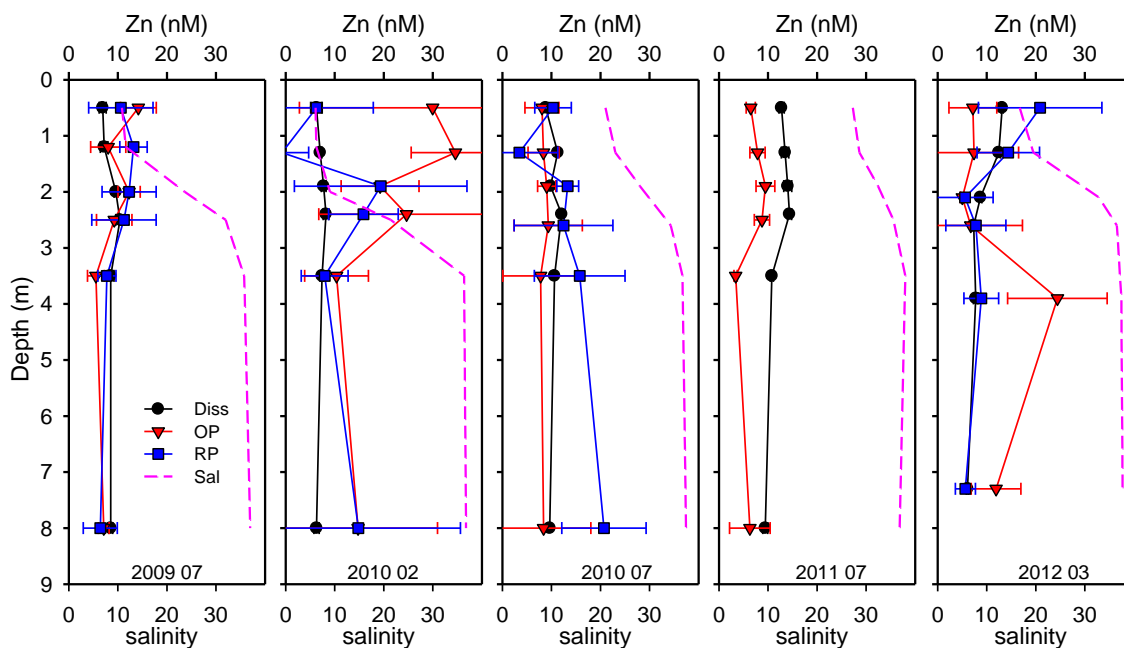

Figure 4.21. Vertical profiles of dissolved (Diss), open pore (OP) and restricted pore (RP) DGT-labile concentrations of Zn for five sampling campaigns at Martinska (“clean”) site.

4.7.2. Cadmium (Cd)

Cadmium is generally considered to be a “problem-free” metal for analysis. Usually, there is no contamination issue, regardless of the applied analysis methodology. Accordingly, very consistent results of vertical profiles of both DGT-labile and dissolved Cd concentrations were obtained, as presented in Fig. 4.22. If examined according to depth, it is clear that for summer 2009 and winter 2010 campaigns, a very good correlation of DGT-labile ($CC = 0.986$) and dissolved ($CC = 0.952$) Cd concentrations with salinity were obtained, suggesting simple mixing of vertically separated water bodies (theoretical “dilution”). Both of these campaigns were characterized by low salinity in the surface water layer, and the two lowest measured Cd concentrations (the same as observed for Zn). Such conservative behaviour of Cd with salinity agrees well with the longitudinal profiles of Cd in the surface layer along the whole estuary transect presented in Fig 4.12, i.e. the concentration of Cd is increasing with salinity (Cd concentration is primarily regulated by the mixing of freshwater and

seawater). The concentration of Cd in the seawater layer (at 3.5 and 8 m depths) was fairly stable (~ 0.080 nM), with variation within only ~ 2 pM. With the exception of the winter of 2010, all vertical profiles of DGT-labile Cd showed a small, but evident increase in concentration within the FSI layer. Such an increase was already evidenced in the Krka estuary and is related to the accumulation of particles, organic matter and trace metals in the FSI layer (Žutić and Legović, 1987).

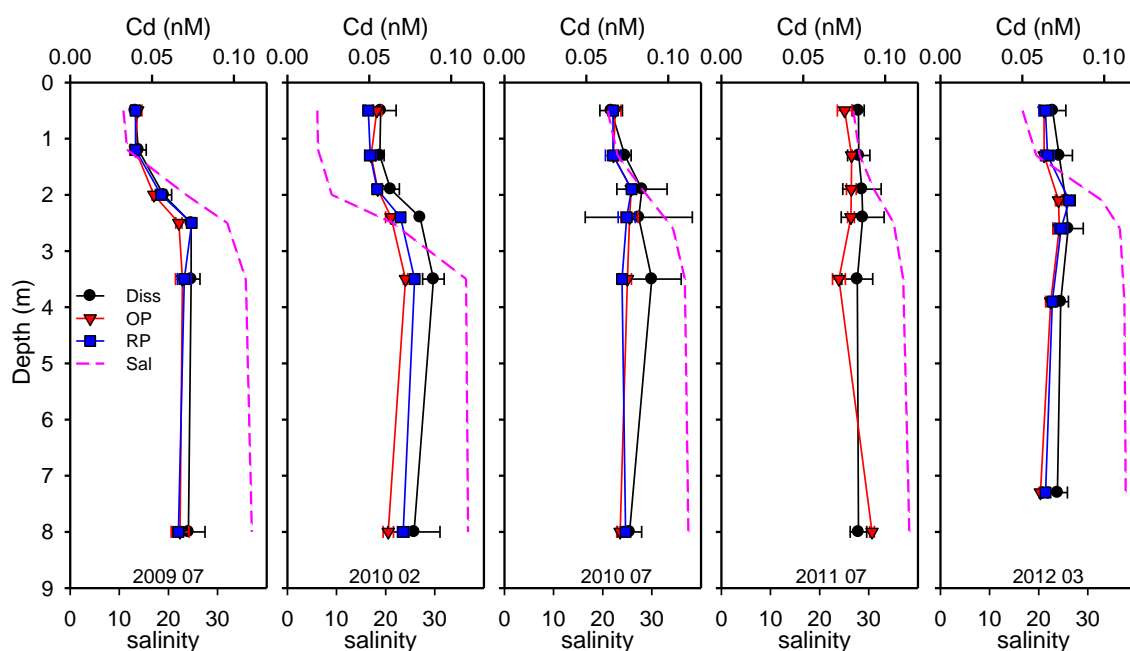

Figure 4.22. Vertical profiles of dissolved (Diss), open pore (OP) and restricted pore (RP) DGT-labile concentrations of Cd for five sampling campaigns at Martinska (“clean”) site.

The range of dissolved Cd concentrations within vertical profiles lower than 0.04 nM, with an average uncertainty of 0.009 nM, demonstrates the importance of obtaining high quality data from analytical measurements, and at the same time, validates our electroanalytical procedure. Thus, a very good correlation of DGT-labile and dissolved Cd concentrations was obtained for all campaigns (see Table 4.4). As expected, in most cases, the dissolved Cd concentration was higher than the DGT-labile concentration. However, no difference was found between open pore (OP) and restricted pore (RP) DGT-labile concentrations.

In addition, a good agreement between dissolved and DGT-labile Cd vertical profiles confirms that a composite sample, compiled from 6 or 12 subsamples, satisfactorily represented the average dissolved Cd concentration during deployment period (ca. 5 days).

4. Results

Table 4.4. Pearson’s Correlation Coefficients (CC; $p = 0.05$) between dissolved Cd, open pore (OP) and restricted pore (RP) DGT-labile Cd concentrations (all samples).

Element	Dissolved	OP	RP
Dissolved	1		
OP	0.886	1	
RP	0.913	0.949	1

4.7.3. Lead (Pb)

Vertical profiles of dissolved and DGT-labile Pb concentrations for all campaigns are presented in Fig. 4.23. The unique characteristic for all profiles is that concentrations of Pb increase with salinity/depth. Such behaviour is in accordance with the vertical profiles of Pb across the estuary (Fig. 4.12).

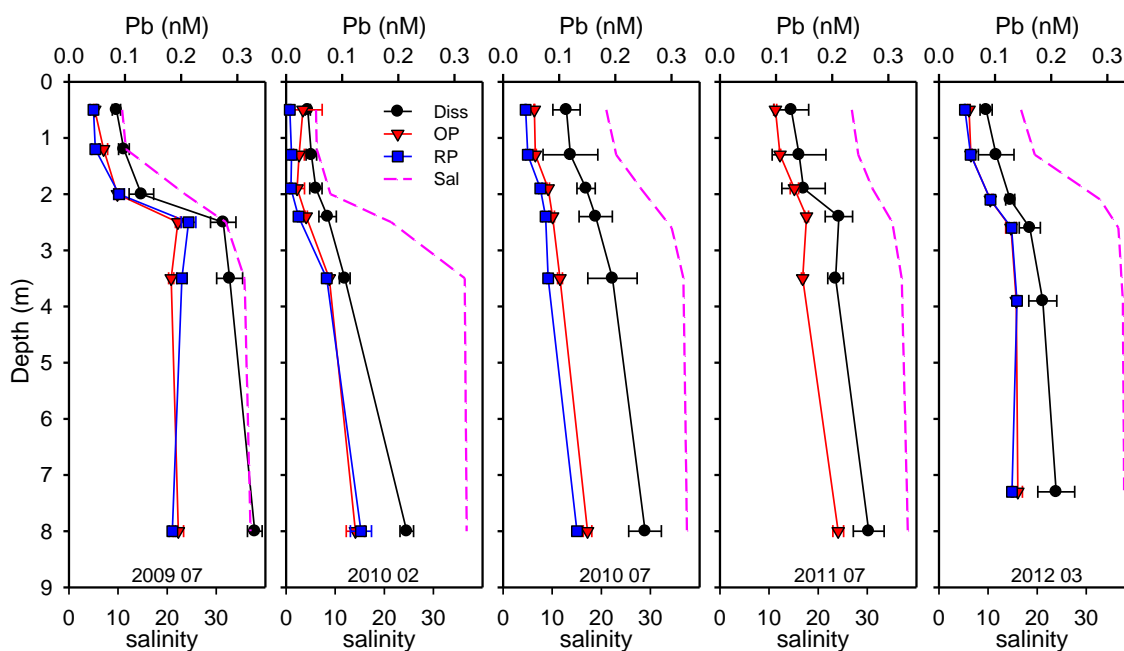

Figure 4.23. Vertical profiles of dissolved (Diss), open pore (OP) and restricted pore (RP) DGT-labile concentrations of Pb for five sampling campaigns at Martinska (“clean”) site.

As noted previously, the Šibenik harbour and the location near the ship overhaul (in the nautical marina area) are identified as the main Pb sources. Spreading of Pb occurs in both horizontal and vertical directions. If concentrations of Pb in the surface layer are examined according to salinity, a clear relationship with a high correlation ($CC = 0.934$) is obtained, suggesting that the level of Pb in the surface layer is regulated mainly by the dilution effect. Compared to “open”-clean seawater ($[Pb] \sim 0.06$ nM), much higher concentrations of Pb (average ~ 0.22 nM) in the seawater layer at the position of the Martinska site were found

(this is not the case for other metals). These elevated concentrations of Pb could be partly explained by the sinking of particles-associated Pb, its release in the dissolved state, and accumulation in seawater due to the competitive effect of major cations. The release of Pb from sediment can be not be excluded; however, a more detailed study would be needed in order to clarify such trends.

High correlation ($CC > 0.95$) between DGT-labile and dissolved Pb concentrations for all campaigns were obtained (see Table 4.5). Dissolved Pb concentrations were always higher than DGT-labile, meaning that only a fraction of total dissolved Pb was captured by the DGT device. A very small or no difference was found between open pore (OP) and restricted pore (RP) DGT-labile Pb concentrations.

Table 4.5. Pearson's Correlation Coefficients (CC ; $p = 0.05$) between dissolved Pb, open pore (OP) and restricted pore (RP) DGT-labile Pb concentrations (all samples).

Element	Dissolved	OP	RP
Dissolved	1		
OP	0.960	1	
RP	0.955	0.987	1

4.7.4. Copper (Cu)

Contrary to other trace metals, in most cases, the vertical profiles of both dissolved and DGT-labile Cu concentrations showed a trend opposite to salinity. Except in the winter of 2010, higher concentrations of Cu were measured in the surface and FSI layers than in the seawater layer. Such a vertically increasing trend was already documented at several estuary sites within Šibenik Bay (see Fig. 4.12). As explained in the previous chapter, higher Cu concentrations in the surface layer measured in the summer are linked to intensive nautical traffic within the bay, and are derived by a Cu release from antifouling paints that are used as a biocide on boats. Due to the high Krka River flow in the winter of 2010 ($>100 \text{ m}^3 \text{ s}^{-1}$, see Fig. 4.13), a low salinity was recorded in the surface layer at the Martinska site, which additionally led to low concentrations of Cu. In a way, this occurrence could be described as a “flushing-dilution” effect. Such conditions did not occur in the winter of 2012 due to the comparatively low Krka River flow ($\sim 40 \text{ m}^3 \text{ s}^{-1}$), producing higher salinity at the study site, and consequently showing a vertical profile similar to the summer campaigns. Whether separately for each season or mutually for both seasons, the concentration of Cu in the surface layer shows a very good correlation with salinity ($CC_{\text{summer}} = 0.99$; $CC_{\text{winter}} = 0.96$,

4. Results

$CC_{\text{both}} = 0.88$), indicating that the level of Cu in the surface layer is regulated by a complex mechanism of Cu input and hydrodynamic/hydrologic conditions with the estuary.

In Chapter I it is shown that the transport of metals from the source occurs in both the horizontal and vertical direction. Depending on the hydrodynamic conditions (e.g. flushing effect), a part of Cu released at the surface is transported downward into deeper layers. However, while 4 times difference was measured in the surface layer between the highest and the lowest Cu concentration, only a small variability (but related to the concentration at surface) was observed in the seawater layer (within ~40%).

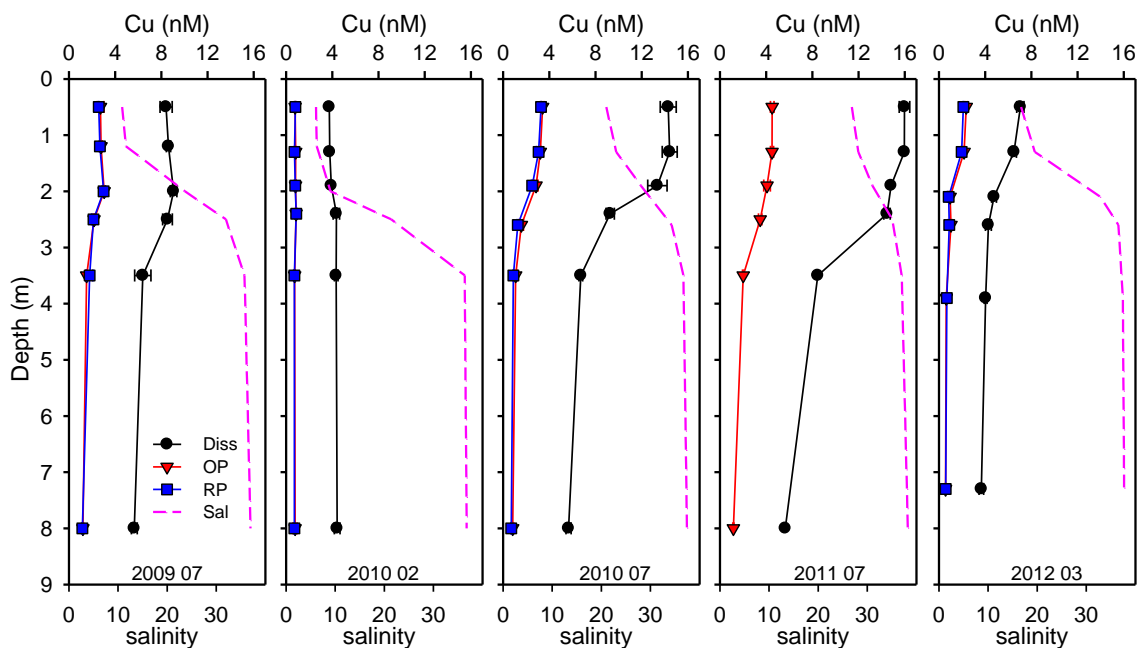

Figure 4.24. Vertical profiles of dissolved (Diss), open pore (OP) and restricted pore (RP) DGT-labile concentrations of Cu for five sampling campaigns at Martinska (“clean”) site.

Table 4.6. Pearson’s Correlation Coefficients (CC; $p = 0.05$) between dissolved Cu, open pore (OP) and restricted pore (RP) DGT-labile Cu concentrations (all samples).

Element	Dissolved	OP	RP
Dissolved	1		
OP	0.946	1	
RP	0.873	0.992	1

The same trends of vertical profiles of dissolved and DGT-labile Cu concentrations, with correlation coefficients higher than 0.87, were obtained for all campaigns, (see Table 4.6). Although it was expected for open pore (OP) DGT devices to provide higher concentrations of DGT-labile Cu compared to restricted pore (RP) DGT, the obtained differences were

within the range of measurement uncertainty. As expected, dissolved Cu concentrations were much higher than DGT-labile, pointing to the existence of a large Cu fraction (most probably organic), not accessible by DGT.

4.7.5. Nickel (Ni)

Well-defined vertical profiles of dissolved and DGT-labile Ni were obtained for all seasons (Fig. 4.25). Concentrations of Ni increase with salinity/depth (correlation coefficient: 0.963; all samples) indicating conservative mixing (Fig. 4.26). If examined according to the conservative line of freshwater/seawater end-members (dashed line in Fig. 4.26), concentrations of Ni at the Martinska site are slightly increased (~ 1 nM in surface layer) pointing to an additional supply of Ni within the bay. As shown previously on contour plots of Šibenik bay (Fig. 4.10b), although Ni concentrations are quite uniform within the majority of the bay, slightly increased concentrations are registered within the nautical marina area and harbour, which caused the mentioned deviation from the ideal conservative line.

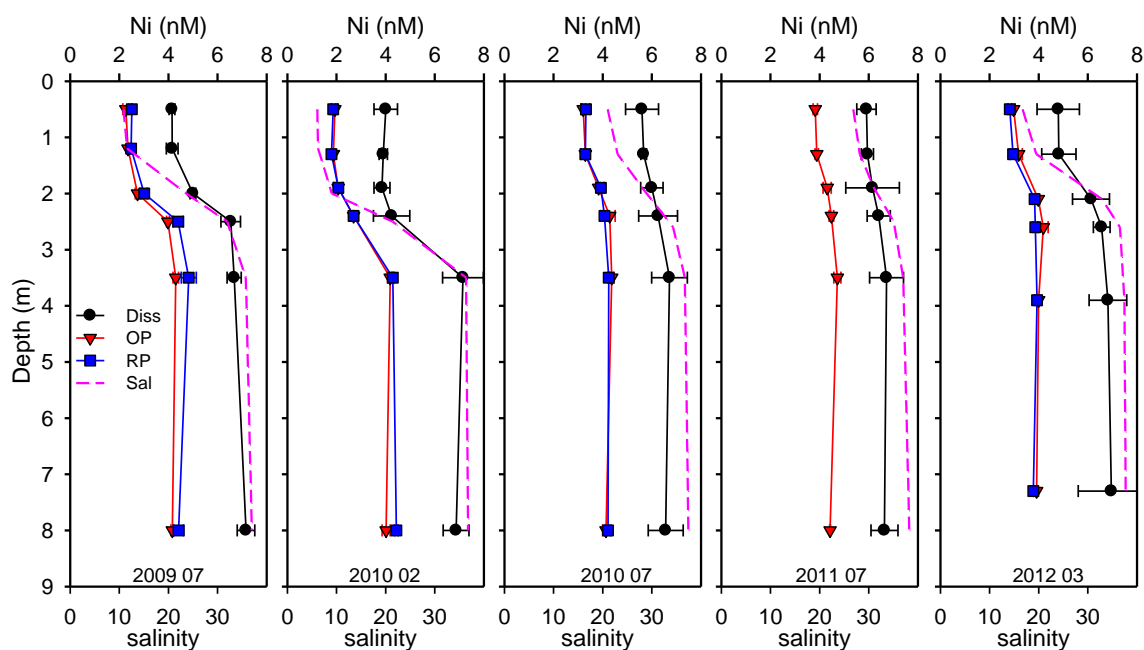

Figure 4.25. Vertical profiles of dissolved (Diss), open pore (OP) and restricted pore (RP) DGT-labile concentrations of Ni for five sampling campaigns at Martinska (“clean”) site.

A very high correlation coefficient between Ni concentrations and salinity in the surface layer ($CC = 0.967$) points to the stable supply of Ni over time. Due to weak supply of Ni, the downward transport of Ni is negligible (differences are within experimental error). Thus, concentrations of Ni in the seawater layer (average \pm SD for all campaigns: 6.8 ± 0.2 , see top-

right corner in Fig. 4.26) are the same as those measured in the seawater end-member, i.e. in the “open” part of the Adriatic Sea (7.0 nM, see Table 4.1, KE-15).

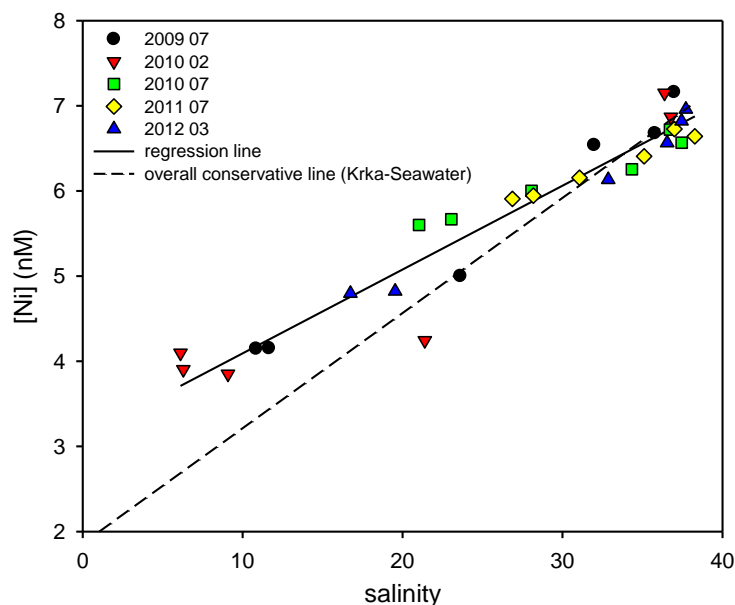

Figure 4.26. Dependence of dissolved Ni concentration on salinity at “clean”, Martinska site (data of all vertical profiles).

For all campaigns, dissolved Ni concentrations were higher than DGT-labile, indicating that not all Ni chemical species are accessible by DGT. The same trends of vertical profiles of dissolved and DGT-labile Ni concentrations, with correlation coefficients higher than 0.94, were obtained for all campaigns (see Table 4.7). As for other metals, there is no regular difference in DGT-labile concentrations measured by open pore (OP) and restricted pore (RP) DGT probes.

Table 4.7. Pearson’s Correlation Coefficients (CC; $p = 0.05$) between dissolved Ni, open pore (OP) and restricted pore (RP) DGT-labile Ni concentrations (all samples).

Element	Dissolved	OP	RP
Dissolved	1		
OP	0.941	1	
RP	0.950	0.968	1

4.7.6. Cobalt (Co)

Compared to other metals, vertical profiles of Co showed the highest variability among the campaigns (Fig. 4.27). No consistent common pattern was found among all data for either

dissolved or DGT-labile Co concentrations. However, excluding the summer of 2009, a clear decreasing trend of (only) dissolved Co concentrations with salinity was registered ($CC = -0.819$). Higher concentrations of Co in the surface layer observed for these campaigns are generally in agreement with the vertical profiles observed during the winter and summer “transect” campaigns (See Fig. 4.12) for this region. Comparing the horizontal profiles of Co along the estuary transect, no consistent behaviour between summer and winter was found. All these data show very high dynamics of Co concentrations within the estuary. Excluding again the summer of 2009, although a relatively uniform vertical profile was obtained for DGT-labile Co concentrations, no correlation with salinity was found. In addition, with the exception of the summer of 2009, no similarity between vertical profiles of dissolved and DGT-labile Co concentrations was obtained (Table 4.8).

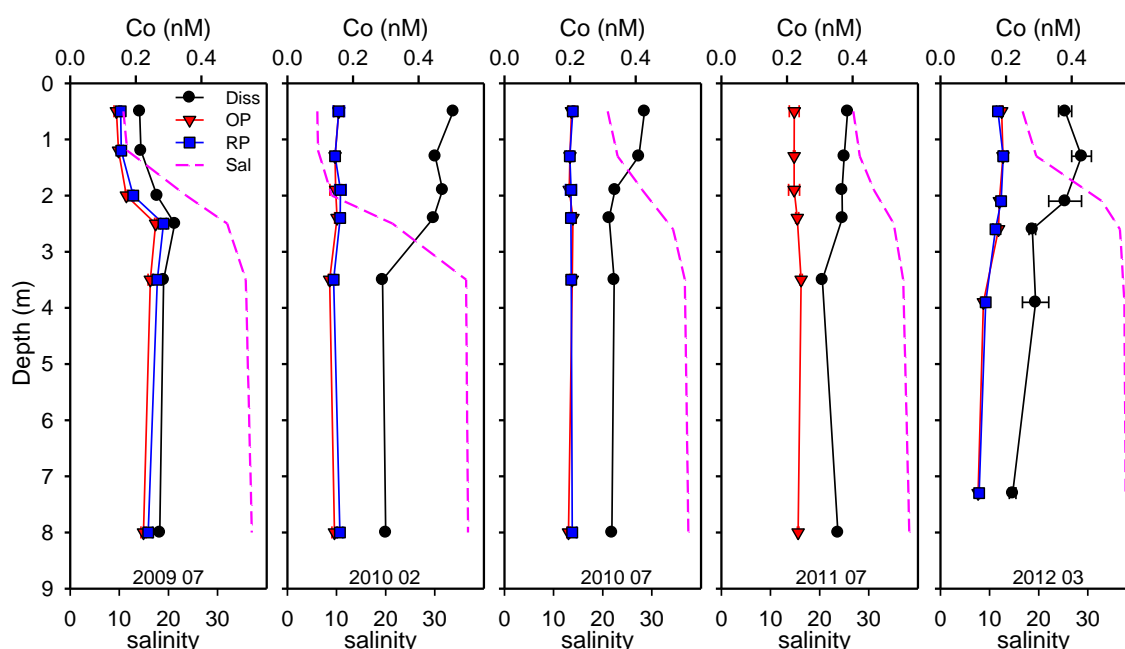

Figure 4.27. Vertical profiles of dissolved (Diss), open pore (OP) and restricted pore (RP) DGT-labile concentrations of Co for five sampling campaigns at Martinska (“clean”) site.

Table 4.8. Pearson’s Correlation Coefficients (CC ; $p = 0.05$) between dissolved Co, open pore (OP) and restricted pore (RP) DGT-labile Ni concentrations without summer 2009 data. In parentheses are provided CC only for summer 2009 data.

Element	Dissolved	OP	RP
Dissolved	1		
OP	0.120 (0.943)	1	
RP	0.066 (0.960)	0.939 (0.997)	1

4.8. Vertical distributions of dissolved and DGT-labile concentrations of trace metals at nautical marina (“polluted”) site

A comparative study between “clean” and “polluted” sites was performed only in the summer of 2009. The nautical marina “Mandalina” was selected as a site characterized by high concentrations of some metals in the water column, but with other parameters similar to the “clean” Martinska site. Very comparable vertical profiles of salinity, temperature and dissolved organic carbon (DOC) for these two sites were obtained (Fig. 4.28). Even though the “polluted” site is not on the main brackish water “stream” flowing out of the Šibenik bay (slightly isolated zone), according to the salinity and temperature profiles, the dynamics of water exchange are sufficiently “fast” enough to maintain conditions similar to the Martinska site (which is located within the brackish water “stream”).

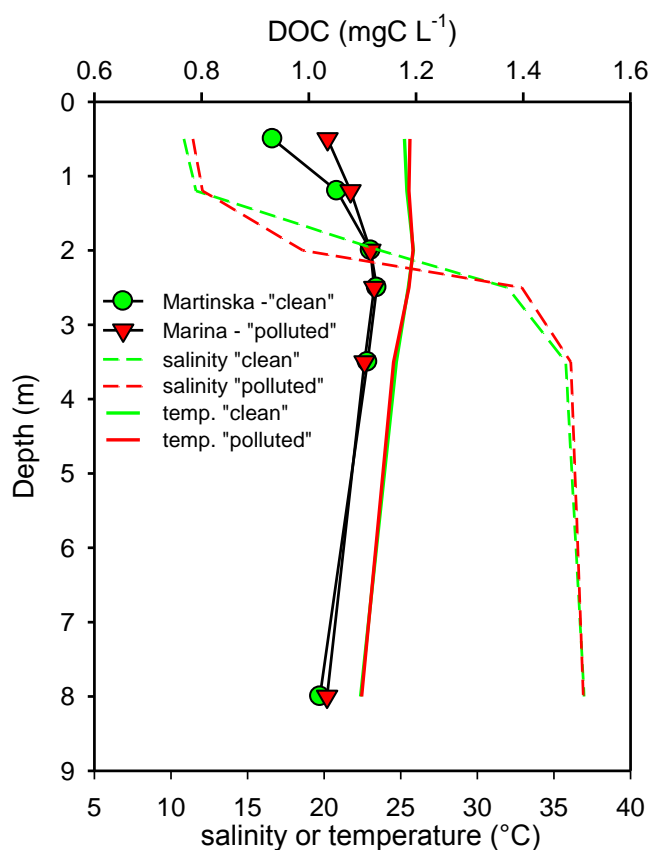

Figure 4.28. Vertical profiles of dissolved organic carbon (DOC) and salinity for the summer 2009 campaigns at the “polluted” (red) and “clean” (green) sites.

Although located in an area with a large number of boats and other marina/harbour activities close to the sampling site, low concentrations of DOC were rather unexpected. However, that was not the case for some trace metals.

Comparative vertical profiles of dissolved and DGT-labile concentrations at the nautical marina and Martinska sites were presented in Fig. 4.29. Except Ni, concentrations of all trace metals measured in the marina were higher in comparison with the concentrations measured at the Martinska site. On average, Zn concentrations increased 4 times, with a higher increase in the surface than in the seawater layer. Although statistically not significant, a similar trend of dissolved Zn concentrations, characterized by the increased concentrations in the FSI layer, were obtained at each site. Due to the relatively high concentrations of Zn at the nautical marina site, it would be expected that contamination issues related to DGT measurements (observed for the Martinska site) would be greatly eliminated; however, unfortunately, that was not the case. Even more so, different concentration profiles of OP and RP DGTs were also obtained. Again, this makes Zn DGT results not very useful for speciation study. Longer deployment times would be of benefit in diminishing the “blank” contamination, but a biofouling of DGT devices is another problem in areas of higher productivity or high particle (inorganic/organic) content.

Around 50% higher concentrations of Cd were obtained in the marina site compared to Martinska. Although with different absolute values, a relative increase is in agreement with the difference obtained during the mapping campaign (surface layer; July, 2012) within Šibenik bay (~7 nM at Martinska and ~12 nM in marina). As for the Martinska site, vertical profiles of both dissolved and DGT-labile Cd concentrations followed the salinity profile. No significant difference was found between dissolved and DGT-labile concentrations.

Similar vertical profiles, with increasing concentrations of Pb with depth were obtained at both sites. At the “polluted” site, Pb concentrations increased from 0.165 nM at surface, to 1.03 nM at a depth of 8 m. In comparison with the “clean” site, except for the deepest position (8 m) for which Pb concentrations increased 3×, at other depths a double increase was recorded. While at the “clean” site, the same vertical profiles of dissolved and DGT-labile Pb concentrations were measured, a deviation for the two points in the seawater layer (3.5 and 8 m) at the “polluted” site was found.

4. Results

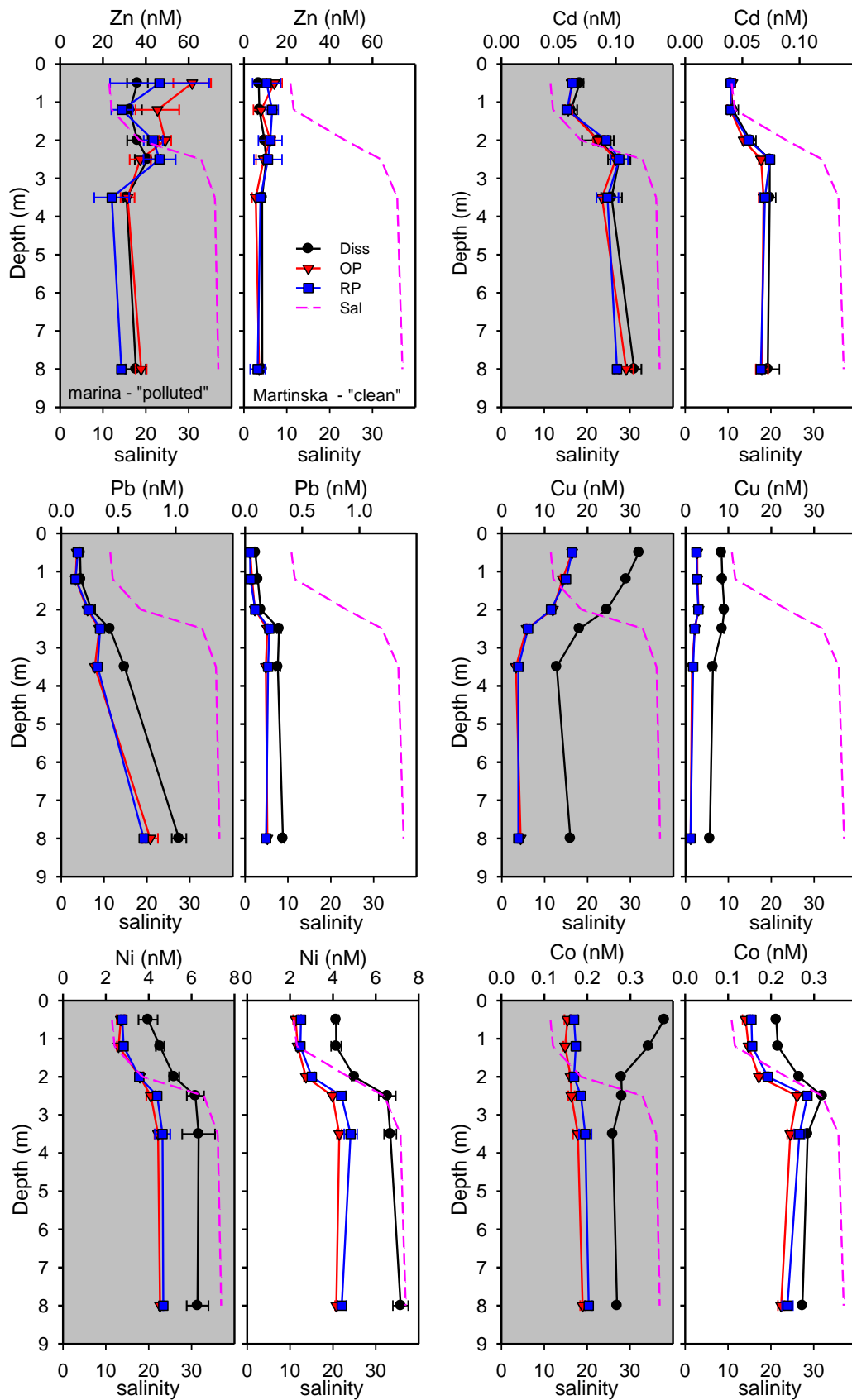

Figure 4.29. Vertical profiles of dissolved (Diss), open pore (OP) and restricted pore (RP) DGT-labile concentrations for summer 2009 campaigns at nautical marina -“polluted” (grey) and Martinska-“clean” (white) sites.

The highest increase in concentration at the “polluted” marina site compared to the “clean” Martinska site was observed for Cu. The extent of increase diminished with depth and was higher for DGT-labile concentrations than for dissolved Cu concentrations ($\sim 6\times$ vs $4\times$ at surface). Relatively high concentrations of Cu at the surface (32 nM of Cu_{diss}), and low at the seawater layer (16 nM of Cu_{diss}) were expected because the site is located in the marina area. As discussed previously, increased concentrations of Cu are the consequence of Cu leaching from the antifouling paints. Comparable vertical profiles of dissolved and DGT-labile Cu concentrations were obtained.

The only metal which retained the same concentrations and same vertical profiles at both sites was Ni. Such behaviour is not unexpected taking into account that during the high-resolution mapping survey in Šibenik bay (summer 2012), Ni showed almost a uniform distribution across the bay (Fig. 4.10b). Although a small increase of Ni was observed at a location near the ship overhaul close to the sampling site, according to the results, the input of Ni was minor during sampling in the summer of 2009.

The highest difference in vertical distributions between “clean” and “polluted” sites was obtained for Co. Contrary to the “clean” site, where concentrations of dissolved Co increased with depth (with a pronounced concentration peak at the FSI layer), at the “polluted” site, the concentration of dissolved Co decreased from 0.38 nM at the surface to 0.27 nM at a depth of 8 m. Vertical profiles of DGT-labile Co concentrations also differ between the two sites. A relatively high variability of Co distribution was also observed during the high-resolution mapping campaign in Šibenik bay (summer 2012; Fig. 4.10b), and thus, the “inconsistent” behaviour of the Co vertical profiles is not very surprising.

CHAPTER III

“Assessing Cu speciation in the Krka River estuary under different environmental and anthropogenic conditions – an electrochemical complexometric titration study”

In order to assess the speciation of Cu within the Krka River estuary under various environmental and anthropogenic conditions in relation to its bioavailability/toxicity, a complementary technique known as the determination of Cu complexing capacity (CuCC), based on a complexometric titration experiment using the electrochemical measurement technique, was employed. Measurements were performed on composite samples (filtered, natural pH) collected during DGT studies. Thus, all major physico-chemical conditions described in the DGT study (Chapter II) are also valid for the CuCC study and will not be repeated in this section. Altogether, 36 experiments leading to CuCC determinations, were performed afterwards. As the determination of CuCC is generally a “tricky” methodology, before presenting the final results, the most significant steps of our methodology are first elaborated and discussed.

4.9. Setup of critical experimental parameters and data treatment methodology for determination CuCC

4.9.1. Selection of accumulation (deposition) potential

Anodic stripping voltammetry (ASV) is applied for the speciation of Cu, i.e. for the determination of complexation parameters (ligand concentrations, L and conditional stability constants, K') in our study. During the accumulation step in ASV, only a fraction of Cu, corresponding primarily to inorganic and weak organic complexes, is reduced at the working electrode (Hg drop). The reduction of other strong and inert complexes is supposed to be excluded by the proper selection of accumulation (deposition) potential. It was demonstrated that pseudopolarographic (PP) measurements could provide useful information on the metal speciation, i.e. existence of particularly labile and inert metal complexes (Croot et al., 1999; Gibbon-Walsh et al., 2012; Louis et al., 2009a; Omanović and Branica, 2003, 2004; Omanović et al., 1996). In our study, we used PP occasionally as a fingerprint method in order to get the dependency of the Cu signal over the wide range of accumulation potential and to find the optimal potential for the complexometric titration experiment. Fig. 4.30

shows a set of pseudopolarograms obtained in the surface sample (summer 2011 campaign) at different concentrations of dissolved Cu in the sample (unspiked and spiked). With the addition of Cu, a clear evolution of the wave at -0.25 V, corresponding to the labile, mostly inorganic Cu fraction is registered. A plateau between -0.5 V and -1.2 V signifies that there are no other complexes which are reducible at that range. At potentials more negative than -1.2 V a second wave was developed, which represents the reduction of strong (inert) Cu complexes, or it could be an experimental/methodological issue related to the desorption of surface active substances (SAS) from the Hg drop, consequently providing higher sensitivity at that very negative range of potential.

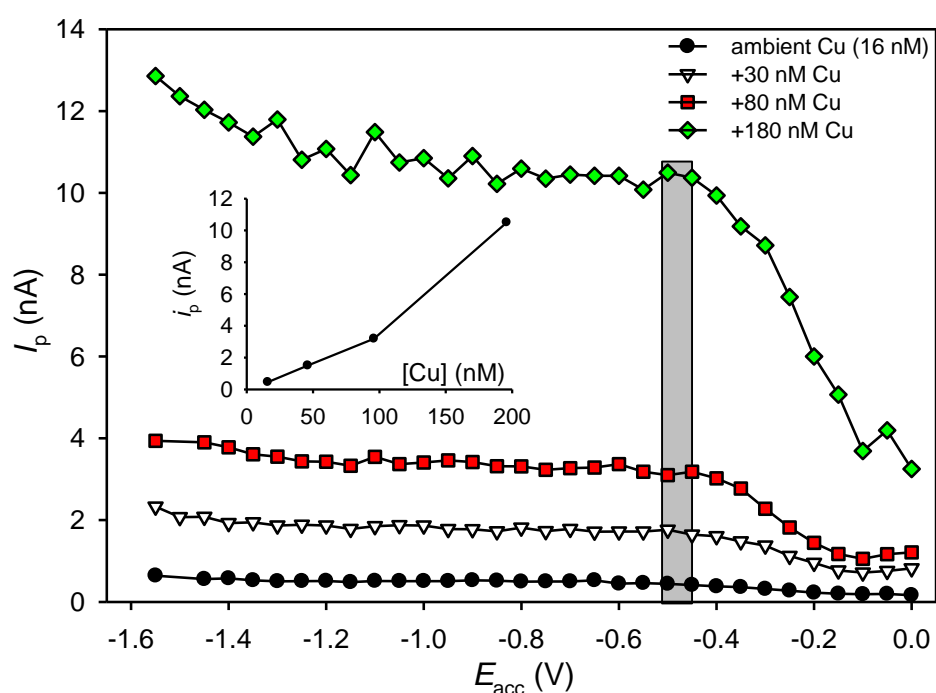

Figure 4.30. Pseudopolarograms of Cu at different added concentrations (0, 30, 80 and 180 nM) recorded in the surface sample (summer 2011 campaign) ($t_{acc} = 180$ s). The vertical grey bar represents the potential of accumulation applied in our complexometric titrations. Inset: dependence of peak current on the concentration of Cu in the sample.

Adsorption of SAS is a known problem in voltammetric measurements, and in our study it is to a large extent eliminated by applying the “desorption” step as described by Louis et al. (2009). Namely, if the accumulation potential is switched to very negative potentials (e.g. -1.4 V) for a short time (e.g. 3 s), at the end of the main accumulation period (e.g. 300 s), an artefact caused by SAS adsorption is greatly eliminated. In our work, we applied this modified methodology, for which it was found to provide more reliable results of

determination of metal complexation (including pseudopolarography and determination of metal complexing capacity).

The marked area in Fig. 4.30 denotes the accumulation potentials (-0.45 V or -0.50 V) used for complexometric titration experiments. As noted previously, the reduction of Cu complexes other than labile ones should be avoided. Thus, the selected accumulation potentials were located only slightly more negative than the position where the maximum intensity of labile Cu complexes reduction was obtained (beginning of plateau).

4.9.2. Equilibration time and titration type

One of the prerequisites for the proper determination of complexation parameters when using complexometric titration data is that the signal intensity is obtained after equilibrium of the added metal (Cu in this case) is reached. The complexation of added metals with natural organic ligands is not instantaneous, and some time is needed for signal stability. The time needed depends on the metal, but also on the sample composition, i.e. other major, minor and trace elements. There are two basic approaches in performing the titration experiment. The first utilizes separate samples, which are pre-equilibrated “overnight” with the spiked metal, while the other approach is based on the sequentially increasing metal concentration in the same sample (electrochemical cell). For our study, we applied the latter approach as it also allows the possibility of determining the complexation parameters by using the kinetic approach (Louis et al., 2009). The equilibration of a sample after the addition of Cu was checked by repetitive measurements of the peak current. An example of such an equilibration curve is presented in Fig. 4.30. Usually, the last two points, registered after 1.5 to 2 hours, were taken into account for obtaining the final titration curve (marked with big circles in Fig. 4.31).

One complexometric titration experiment is composed of 15 Cu additions (+ the measurement of the initial Cu concentration), which is in total, more than 23 hours of automated experiment. In order to avoid evaporation of the sample over a prolonged time, before entering the cell (the nitrogen blanket needs to be kept over the sample solution in order to avoid oxygen dissolution), nitrogen gas was passed through MQ water in order to be saturated with water vapour. In order to keep the pH of the sample stable over the time (pH = 8.2±0.1), a borate buffer (0.01 M) was added.

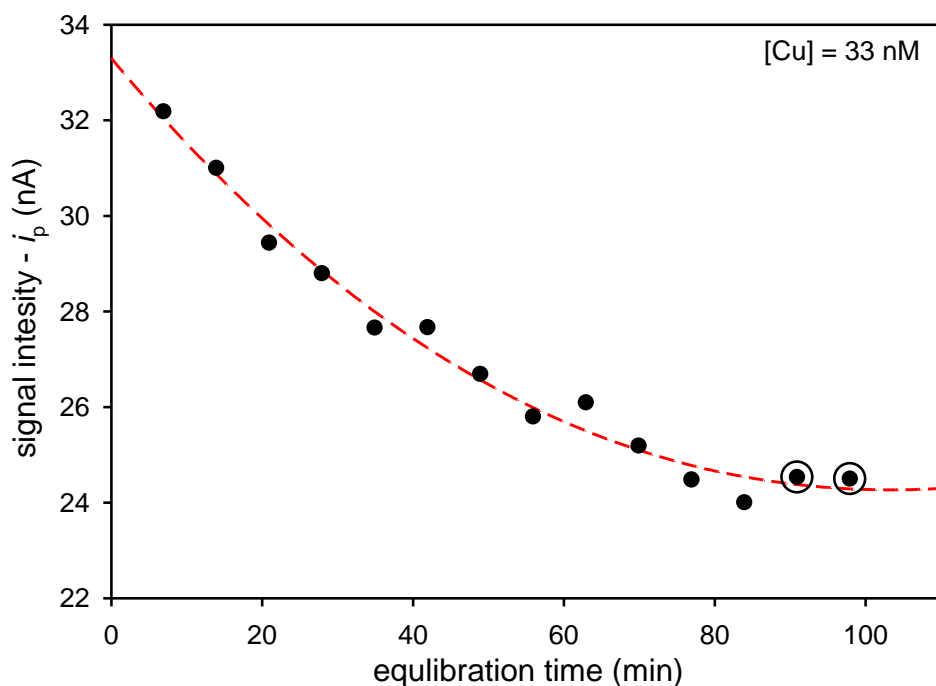

Figure 4.31. Dependence of peak current (i_p) on time after the addition of Cu to the sample (surface sample, summer 2011). The red dotted line is the regression line of 3rd order.

Table 4.9. Methodology of preparing additions for logarithmic type complexometric titration.

	STD (M)	Add (μ L)	Conc (nM)	LgConc	V_tot (mL)	Conc_add (nM)
Initial	-	-	16.00	-7.80	20.00	-
Add_01	1.0E-06	70	19.50	-7.71	20.07	3.49
Add_02	1.0E-06	80	23.50	-7.63	20.15	7.46
Add_03	1.0E-06	110	28.90	-7.54	20.26	12.90
Add_04	1.0E-05	10	33.80	-7.47	20.27	17.80
Add_05	1.0E-05	20	43.70	-7.36	20.29	27.70
Add_06	1.0E-05	20	53.50	-7.27	20.31	37.50
Add_07	1.0E-05	20	63.40	-7.20	20.33	47.40
Add_08	1.0E-05	30	78.10	-7.11	20.36	62.10
Add_09	1.0E-05	30	92.80	-7.03	20.39	76.80
Add_10	1.0E-05	40	112.00	-6.95	20.43	96.40
Add_11	1.0E-05	50	137.00	-6.86	20.48	121.00
Add_12	1.0E-05	60	166.00	-6.78	20.54	150.00
Add_13	1.0E-05	80	205.00	-6.69	20.62	189.00
Add_14	1.0E-05	80	243.00	-6.61	20.70	227.00
Add_15	1.0E-04	10	292.00	-6.53	20.71	276.00

STD – concentration of metal in stock solution; Add – volume of stock solution to be added (in μ L); Conc – total concentration of metal in solution (titration point); LgConc – logarithm of total concentration of metal in solution; V_tot – total volume of sample (including additions); Conc_add – added metal concentrations

4. Results

The interaction of metals with active sites of natural organic matter is usually described by two types of ligands denoted as L_1 and L_2 . Complexes formed with L_1 are usually stronger, and concentration of these ligands is lower than that of L_2 . Thus in order to have a sufficient number of titration points in the range of dominance of both ligands, a logarithmic type of addition was applied (Garnier et al., 2004). For easy handling, a simple program (Calc_Log_Conc) was developed and is used to simplify the preparation of the automated sequence of Cu additions. As a starting point, the user should define the starting volume of the sample, the initial concentration of Cu in the sample, the number of additions, the concentration of the highest titration point, and the concentrations of stock solution which will be used for additions. The program will then automatically redistribute the additions in logarithmic scale and prepare the file which is needed for automation of the titration (Table 4.9).

Once the titration is performed, a corresponding set of voltammograms (at least 32), as presented in Fig. 4.32 (only one voltammogram per addition is plotted), is obtained. Depending on the initial concentration of Cu in the sample, a more or less defined peak is obtained (first black line). A 297-second period of accumulation, followed by a 3-second “desorption step”, was sufficient to get a measurable peak in all un-spiked samples.

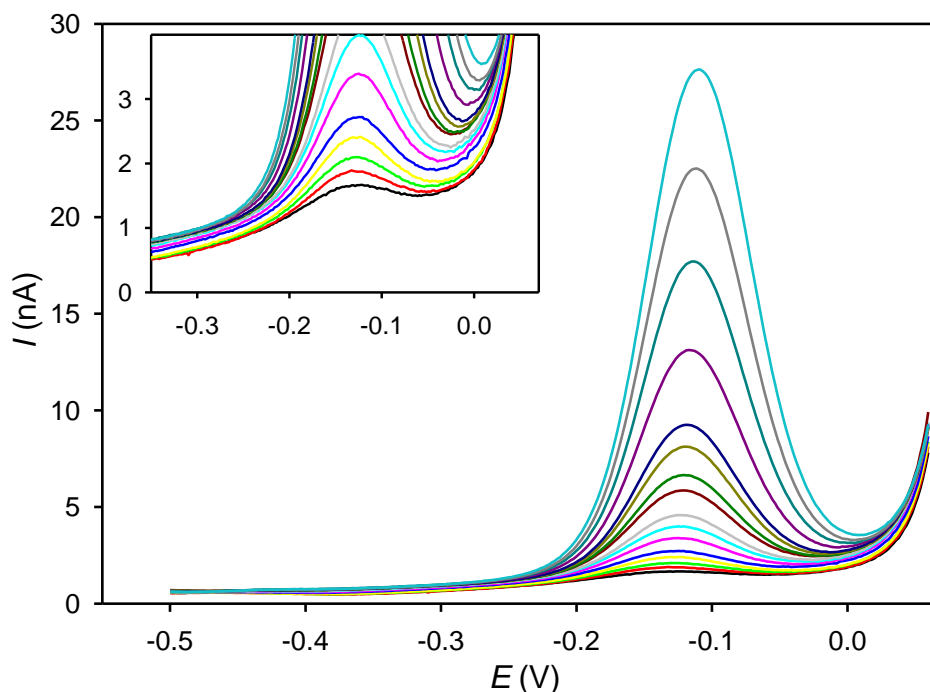

Figure 4.32. An example of 16 voltammograms obtained at increasing Cu concentrations during a complexometric titration experiment of a surface sample, summer 2011 (only one curve per addition was plotted). Inset: selected set of voltammograms showing an increase in the Cu oxidation peak at low additions.

4.9.3. Treatment of voltammograms - signal intensity feature determination

Once the voltammograms are acquired, the next step is to “extract” useful information about the signal (peak) intensity, needed to construct the complexometric titration curve from which complexation parameters (ligand concentrations and conditional stability constants) could be estimated (calculated). Different “measures” could be used to characterize the signal. The most utilized is the peak height based on the “tangent fit” method, which approximates the baseline using the straight line (green dotted line in Fig. 4.33A). However, this method underestimates the peak height (ca. 20% in the presented example), which could produce an artefact as an additional non-existing ligand in the analysed sample (Omanović et al., 2010). To avoid this problem, a curvature baseline should be drawn and subtracted from each voltammogram (see Fig. 4.33A).

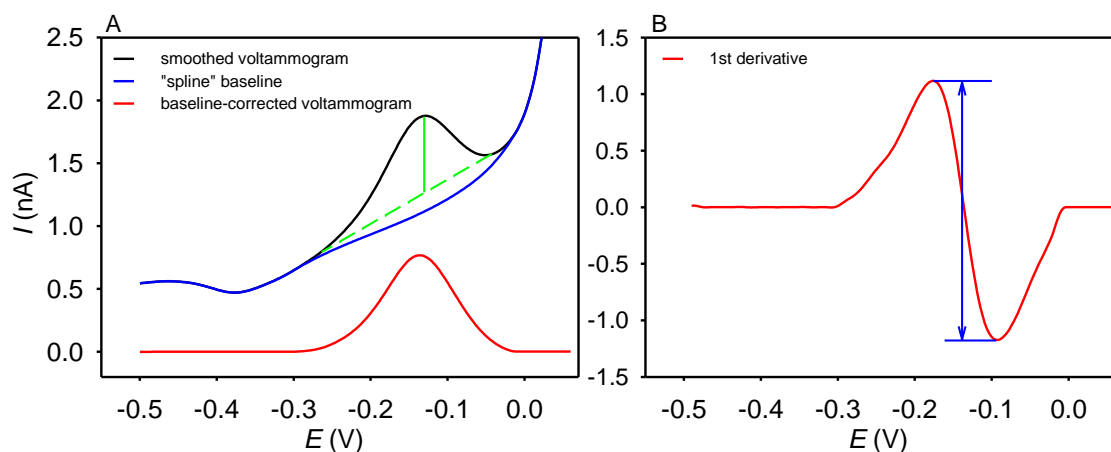

Figure 4.33. (A) An example of the baseline approximation methods (green dashed line – “tangent fit”; blue line – curvature spline baseline) and (B) baseline-corrected voltammogram (red curve in A plot) transformed by 1st Derivative showing the method of extraction of signal feature.

However, manual adjustment on a very large number of voltammograms is not practical, and thus, a “compromise” solution was employed: a unique curvature baseline (blue curve in Fig. 4.32) was constructed and was subtracted from each voltammogram. As the baseline of each separate voltammogram was not always at the same absolute value (see voltammograms in Fig. 4.32) the peak height was discarded as a signal measure. Thus, in order to “account” for the change in the baseline, the transformation of voltammograms by 1st Derivative was applied as is presented in Fig. 4.33B. Finally, a difference between the maximum and minimum of the 1st Derivatives was used as a signal intensity feature (blue arrow in Fig. 4.33B) to construct the complexometric titration curve. All of these treatments, including the

4. Results

smoothing of the voltammograms were automatically performed using the ECDOSFT program, developed in our laboratory (D. Omanović) specifically for the treatment of voltammetric curves.

4.9.4. Treatment of complexometric titration curves – fitting to a model

As mentioned above, complexometric titration curves are interpreted assuming a discrete model which presumes the existence of one, two or more ligand classes (L_1, L_2, \dots, L_n) with sufficiently different binding properties. The most common methods for data treatment i.e. determination of complexation parameters (ligand concentrations and conditional stability constants) are known as linearizing Ružić-van den Berg (Ružić, 1982; van den Berg, 1982), Scatchard (1949) and transforming Langmuir/Gerringa (Gerringa et al., 1995) methods. All these methods are incorporated within the ProMCC software which is used as data treatment tool (Omanović et al., 2015). Fig. 4.34 shows a snapshot of the graphical user interface of the program, with an example of experimental data fitting.

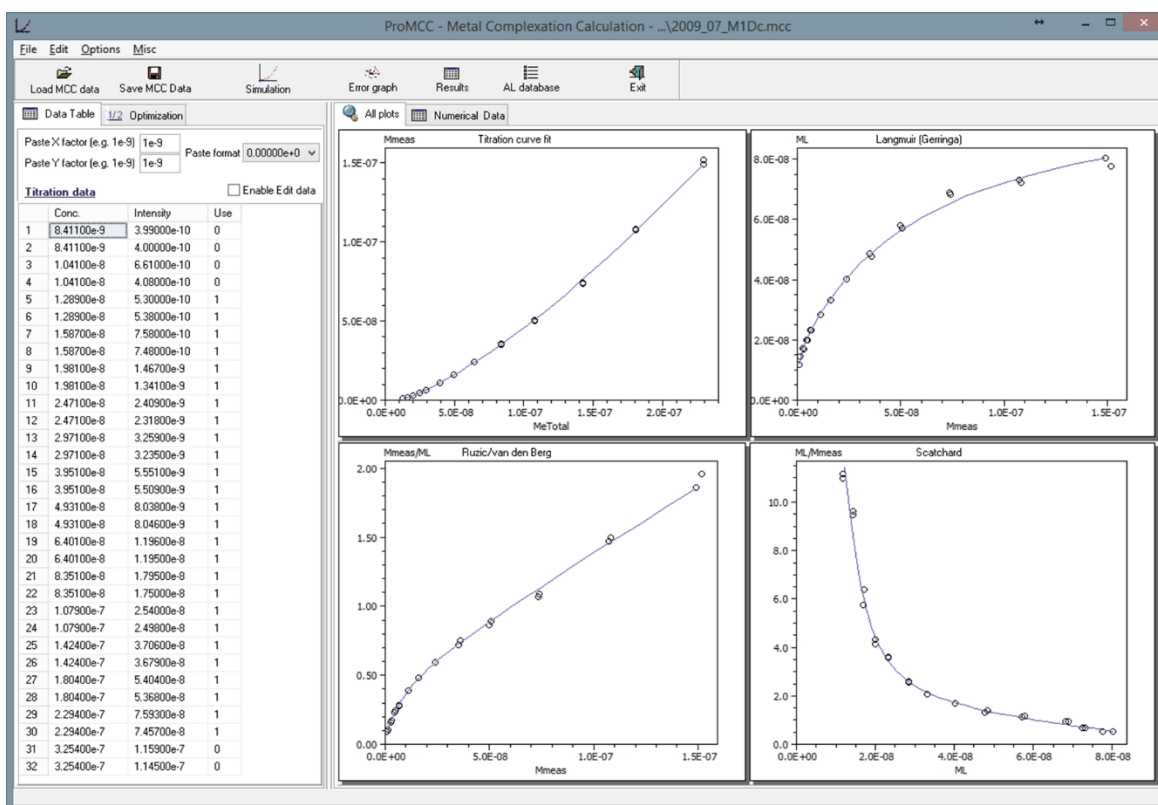

Figure 4.34. Snapshot of the ProMCC program showing an example of fitting experimental data (surface sample, summer 2009, “clean” site). Points are experimental data, and blue line is fitted curve.

On the upper left plot, the signal intensity feature was converted to concentration using the estimated sensitivity, and plotted against the total metal concentration. Data were visualized in Ružić/van den Berg, Scatchard and Langmuir/Gerringa transformations (lower left, lower right, and upper right, respectively). The blue line is obtained from results of fitting to a model of two ligands.

The two major starting steps in preparing data for the fitting are the estimation of the sensitivity (needed to convert the signal feature to concentration), and the selection of the correct model (number of ligand classes). These two steps are interconnected, i.e. by changing the sensitivity in case of the existence of only one ligand class, one can virtually obtain two ligand classes if the sensitivity is overestimated. Fig. 4.35 shows a Scatchard plot of a simulated (noised) titration curve for a one-ligand model. In case of a one-ligand model and the correct adjustment of sensitivity, the Scatchard plot should be linear (left plot in Fig. 4.35). For a two-ligand model, a curvature shape is expected (see Fig. 4.34); however, a similar curvature could be obtained in the case of a one-ligand model if the sensitivity is overestimated (in the presented example by only 10%, right plot in Fig. 4.35). Thus, the setup of the correct sensitivity is a very important step in obtaining reliable complexation parameters.

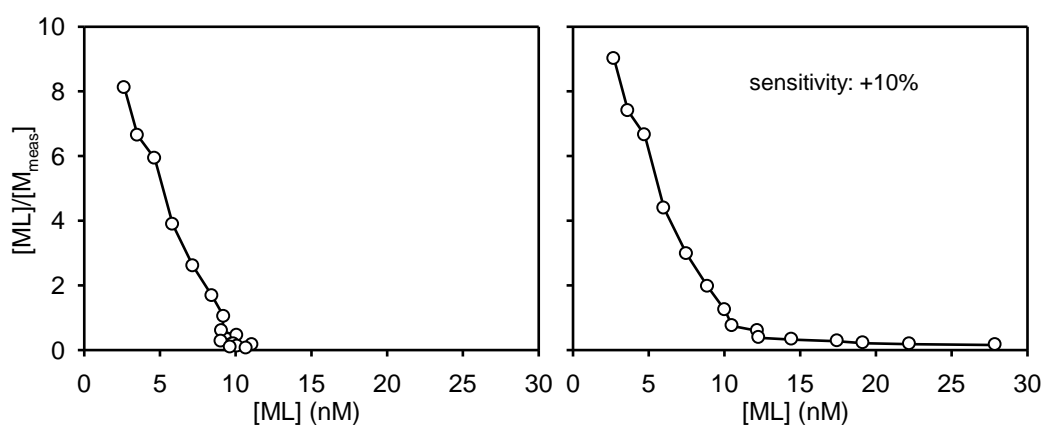

Figure 4.35. Simulated one-ligand model being shown as a Scatchard plot with the correct sensitivity (left plot) and 10% of overestimated sensitivity (right plot).

Recursive and direct fitting methods of automatic adjustment of sensitivity are available within ProMCC (see Omanović et al., 2015. for details). While both methods work almost perfectly on simulated noised data, real experimental data are much more complex, so applying the automated sensitivity adjustment could, in some cases, lead to highly over- and under-estimated values. Although both of these methods are utilized in this work as an

optional control method, the final decision of the “true” sensitivity was based on the visual inspection of all linearized graphs and on the user experience.

4.9.5. Complexometric titration curves

Fig. 4.36 shows obtained complexometric titration curves for all analysed samples in linear (A1) and logarithmic (B1) scale. As it is obvious, different signal intensities were obtained for the same total Cu concentration. In part, this is due to the different amount of complexed Cu, but mostly it is because of a different measurement setup, i.e. size of the drop, stirring conditions, etc., which do not have an influence on the determination of complexation parameters or the influence is negligible (stirring intensity).

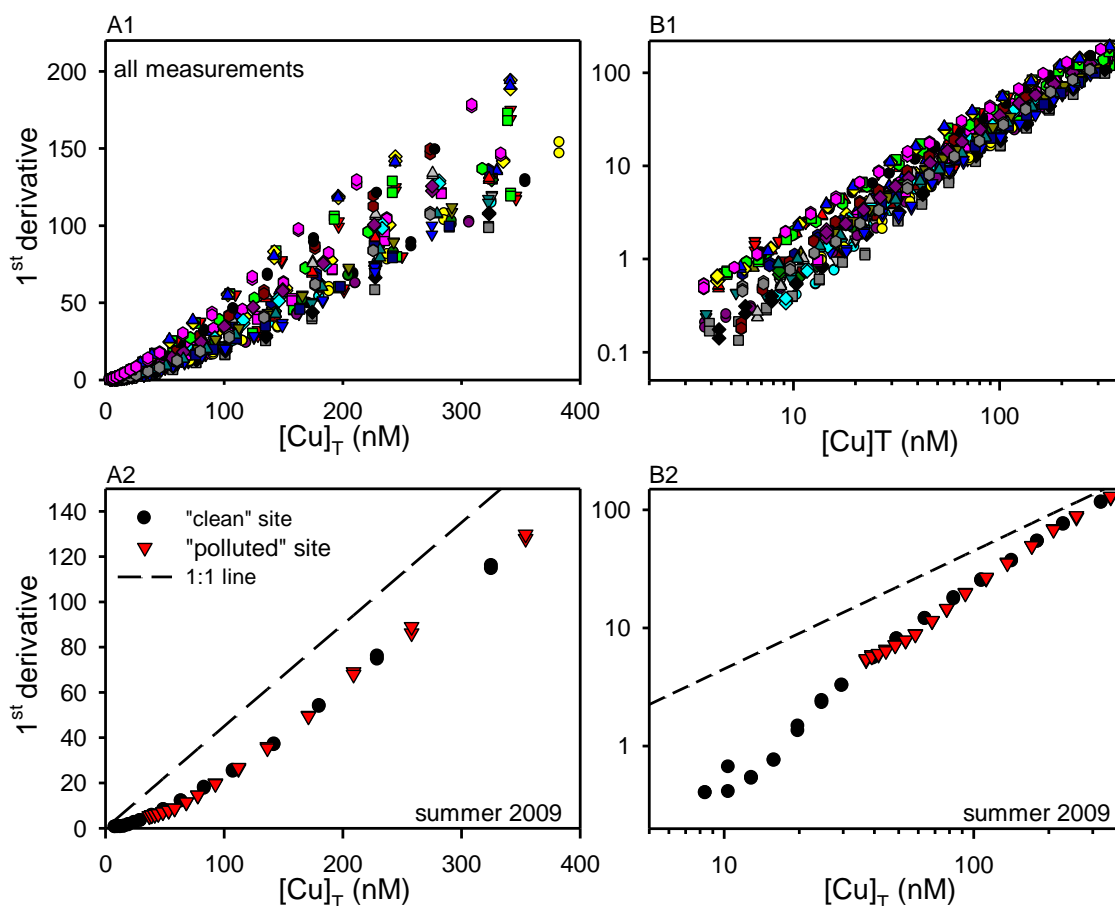

Figure 4.36. All complexometric titration data (36 sets) presented in linear (A1) and logarithmic scales (B1). Complexometric titrations corresponding to surface samples of “clean” and “polluted” sites (A2, B2) (summer 2009 campaign).

The two bottom plots in Fig. 4.36 show examples of titration curves obtained for the same season (summer 2009) but for two different sites (samples): “clean” and “polluted”. As the same electrode setup was used for both titrations, the same sensitivity was obtained. Log-log plot (B2) clearly demonstrates the differences between these two samples in terms of distribution of titration points, which have an influence on the determination of complexation parameters for these two samples (this will be discussed later on in the text).

Most of the 36 complexometric titration data sets were fitted into a two-ligand model, applying the Langmuir/Gerringa fitting routine in Log-Log mode (Omanović et al., 2015). Only four data sets, which correspond to the water samples in the upper layer of the “polluted” site (nautical marina), matched the one-ligand model. Free ($[\text{Cu}^{2+}]$) and inorganic Cu ($[\text{Cu}_{\text{inor}}]$) at its ambient total dissolved concentration ($[\text{Cu}]_{\text{T}}$) were calculated (parameters related to bioavailability/toxicity of Cu) from the accepted parameters obtained by fitting. In order to calculate free Cu concentration, an inorganic side reaction coefficient ($\alpha_{\text{Cu}'}$) needs to be calculated.

As the composition of the samples is different depending on the depth/season, this should be done for each sample separately. The concentration of major ions (Cl^- , SO_4^{2-} , HCO_3^- , Br^- , F^- , Na^{2+} , Mg^{2+} , Ca^{2+} , K^+ , Sr^{2+}) is calculated based on the Dittmar law, which assumes the same proportions between concentrations of major ions in relation to salinity. Only the concentration of carbonate (HCO_3^-) was calculated separately based on the dependence of dissolved inorganic carbon (DIC) on salinity measured during the “transect” campaign in winter and summer (see Fig. 4.4). Once the concentrations were calculated (in Excel), a table with input parameters was loaded into the Visual MINTEQ v3.0 program, which was used to finally calculate the free Cu concentration at a fixed $\text{pH} = 8.2$. The obtained $\alpha_{\text{Cu}'}$, graphically presented in Fig. 4.37, clearly shows the difference between summer and winter, primarily because of the difference in concentration of carbonates, which is the major inorganic ligand for Cu.

All the obtained results are tabulated in Table 4.10 and will be interpreted and discussed together with other parameters of the same samples (season, depth, salinity, content of DOC,...) in the Discussion section.

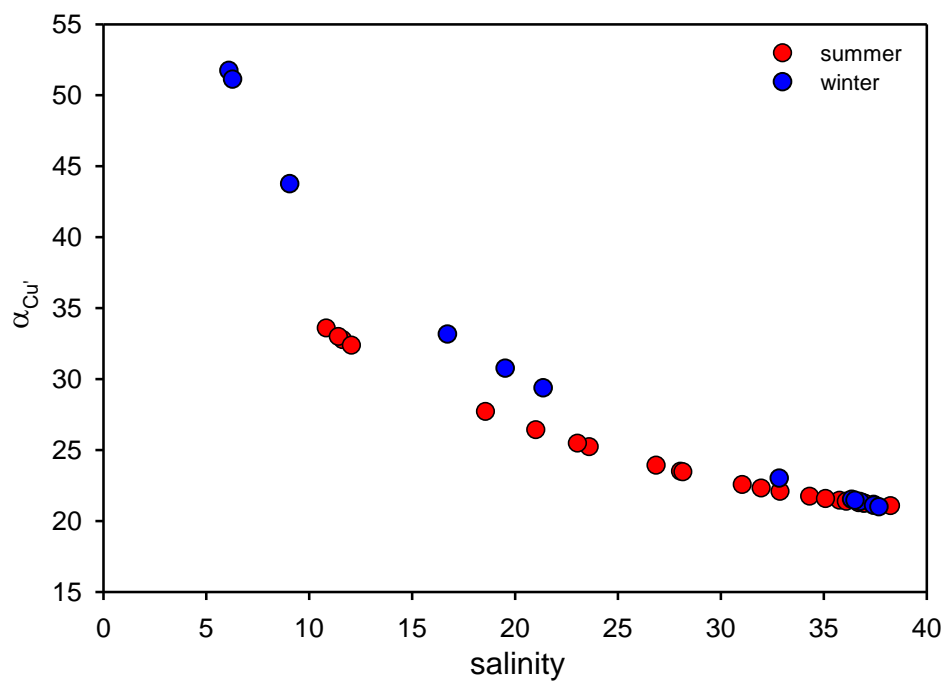

Figure 4.37. Dependence of the inorganic side reaction coefficients of Cu ($\alpha_{Cu'}$) on salinity calculated for summer (red) and winter (blue) samples.

Table 4.10. Compilation of all relevant data and results related to determination of CuCC in collected composite samples.

Campaign	Site	Season	Layer	Salinity	DOC	Depth	Sensit.	$\alpha(\text{Cu}_{\text{Dp}})$	Cu(amb)	Cu(in)	Cu(free)	L1	L2	logK1	logK2	\pm				
2009_07	Martinska	S	FW1	10.85	0.933	0.5	0.50	33.56	8.41	0.433	0.223	0.007	15.19	1.67	10.86	0.17	92.73	6.34	8.73	0.080
2009_07	Martinska	S	FW2	11.65	1.053	1.2	0.51	32.75	8.62	0.706	0.359	0.011	16.51	2.60	10.52	0.16	73.68	4.09	8.80	0.094
2009_07	Martinska	S	FSII	23.62	1.115	2.0	0.56	25.19	9.06	0.693	0.440	0.028	12.52	2.04	10.67	0.25	87.17	3.51	8.75	0.065
2009_07	Martinska	S	FSI2	31.98	1.127	2.5	0.52	22.27	8.54	0.771	0.288	0.013	13.04	1.32	10.51	0.12	71.72	3.82	8.55	0.069
2009_07	Martinska	S	SW1	35.78	1.110	3.5	0.51	21.42	6.39	1.211	1.164	0.057	21.26	10.63	9.66	0.23	38.42	6.74	8.59	0.338
2009_07	Martinska	S	SW2	36.98	1.021	8.0	0.50	21.21	5.66	1.074	0.879	0.051	13.99	5.18	9.89	0.27	44.55	4.44	8.47	0.214
2009_07	Marina	S	FW1	11.44	1.035	0.5	0.45	32.95	37.03	10.753	0.996	0.326	0.030	0.00	0.00	0.00	69.14	2.45	10.79	0.042
2009_07	Marina	S	FW2	12.07	1.078	1.2	0.45	32.35	28.99	8.251	0.779	0.255	0.024	0.00	0.00	0.00	83.21	3.56	10.62	0.038
2009_07	Marina	S	FSII	18.59	1.115	2.0	0.45	27.68	24.48	7.581	0.665	0.274	0.024	0.00	0.00	0.00	77.24	3.34	10.45	0.036
2009_07	Marina	S	FSI2	32.9	1.122	2.5	0.50	22.04	18.13	5.182	0.365	0.235	0.017	0.00	0.00	0.00	38.58	1.01	10.68	0.032
2009_07	Marina	S	SW1	36.12	1.104	3.5	0.52	21.35	12.82	2.852	1.801	0.134	14.88	3.86	11.34	0.235	30.94	2.69	9.88	0.218
2009_07	Marina	S	SW2	36.93	1.034	8.0	0.53	21.22	16.02	3.722	1.744	0.175	22.00	4.30	11.11	0.131	13.85	2.78	9.93	0.345
2010_02	Martinska	W	FW1	6.12	0.815	0.5	0.47	51.71	3.75	0.351	0.318	0.007	13.11	5.45	10.57	0.23	86.66	9.20	9.12	0.169
2010_02	Martinska	W	FW2	6.30	0.809	1.2	0.50	51.09	3.78	0.369	0.209	0.007	13.54	3.44	10.55	0.16	91.82	7.24	9.00	0.113
2010_02	Martinska	W	FSII	9.08	0.808	2.0	0.45	43.72	3.92	0.305	0.179	0.007	26.28	6.94	10.29	0.13	102.90	12.40	8.83	0.182
2010_02	Martinska	W	FSI2	21.39	0.847	2.5	0.47	29.34	4.36	0.380	0.173	0.013	15.83	3.40	10.29	0.12	97.93	6.74	8.78	0.101
2010_02	Martinska	W	SW1	36.38	0.943	3.5	0.46	21.48	4.34	1.125	0.381	0.052	5.38	0.93	10.27	0.13	19.91	1.08	8.75	0.105
2010_02	Martinska	W	SW2	36.78	0.928	8.0	0.48	21.32	4.42	1.348	0.887	0.063	13.24	2.25	9.67	0.09	11.73	81.29	7.76	3.990
2010_07	Martinska	S	FW1	21.03	1.404	0.5	0.59	26.38	13.76	1.576	1.978	0.075	20.26	12.97	10.08	0.39	111.40	10.10	8.76	0.187
2010_07	Martinska	S	FW2	23.05	1.505	1.3	0.59	25.44	15.11	1.621	2.752	0.108	19.69	12.18	10.23	0.57	130.70	20.50	8.61	0.246
2010_07	Martinska	S	FSII	28.06	1.474	1.9	0.60	23.47	13.13	1.631	2.906	0.124	8.58	3.61	12.08	14.203	89.52	7.92	8.70	0.135
2010_07	Martinska	S	FSI2	34.34	1.347	2.6	0.60	21.70	9.19	0.581	0.799	0.027	7.94	1.14	11.81	1.27	71.00	3.58	8.77	0.066
2010_07	Martinska	S	SW1	36.72	1.139	3.5	0.60	21.25	6.69	0.411	0.270	0.013	6.93	0.83	11.30	0.28	49.27	1.84	8.91	0.056
2010_07	Martinska	S	SW2	37.45	0.971	8.0	0.70	21.14	5.59	0.442	0.263	0.021	8.21	1.28	10.76	0.21	63.47	3.08	8.70	0.071
2011_07	Martinska	S	FW1	26.87	1.420	0.5	0.43	23.89	15.97	3.542	1.756	0.148	12.13	2.17	10.48	0.35	51.81	2.49	8.54	0.095
2011_07	Martinska	S	FW2	28.18	1.450	1.3	0.49	23.42	15.96	3.878	1.586	0.166	16.66	3.45	9.89	0.17	66.72	3.65	8.41	0.110
2011_07	Martinska	S	FSII	31.06	1.403	1.9	0.48	22.53	14.81	3.577	3.243	0.159	8.73	7.97	10.08	0.982	92.13	5.33	8.60	0.128
2011_07	Martinska	S	FSI2	35.10	1.270	2.5	0.56	21.55	14.46	2.988	2.490	0.139	9.98	4.45	10.36	0.63	45.46	3.28	8.83	0.116
2011_07	Martinska	S	SW1	37.00	1.042	3.5	0.54	21.21	8.47	1.426	0.583	0.067	27.96	6.34	9.59	0.10	76.21	5.20	8.40	0.151
2011_07	Martinska	S	SW2	38.27	0.967	8.0	0.52	21.03	5.66	0.787	0.512	0.037	16.51	5.77	9.90	0.17	60.26	4.34	8.68	0.147
2012_03	Martinska	W	FW1	16.74	0.659	0.5	0.61	33.13	7.05	1.892	0.785	0.057	2.66	0.29	11.86	10.60	42.45	2.33	9.05	0.015
2012_03	Martinska	W	FW2	19.54	0.683	1.3	0.62	30.72	6.50	1.630	2.355	0.053	5.60	5.28	10.52	1.03	20.50	3.85	9.11	0.288
2012_03	Martinska	W	FSII	32.86	0.791	2.1	0.66	22.97	4.77	0.826	0.529	0.036	7.32	1.75	10.39	0.22	18.77	1.39	8.88	0.166
2012_03	Martinska	W	FSI2	36.54	0.804	2.6	0.69	21.42	4.28	0.666	0.742	0.031	4.70	1.97	10.70	0.55	21.63	1.56	9.06	0.138
2012_03	Martinska	W	SW1	37.44	0.777	3.9	0.68	21.07	4.05	0.743	0.790	0.035	8.75	3.67	10.17	0.31	18.56	3.74	8.64	0.411
2012_03	Martinska	W	SW2	37.71	0.803	7.3	0.70	20.96	3.67	0.685	0.495	0.033	4.96	1.64	10.44	0.25	35.12	4.40	8.75	0.162

5. Discussion

CHAPTER I

“Evidencing the natural and anthropogenic processes controlling trace metals dynamic in the Krka River estuary”

5.1. Conceptual hydrodynamic model of element transport

Principally, in the absence of additional sources within the two end-members, the distribution of suspended material and elements within the salinity gradient is regulated by the physico-chemical processes (mainly adsorption/desorption), leading (usually, but not necessarily) to a positive or negative deviation from the theoretical dilution line (conservative behaviour). For estuaries with a relatively homogenous vertical salinity and strong currents, the transport of elements is basically considered to be a one-dimensional process. However, a characteristic of the salt-wedge estuaries is its strong salinity stratification in the surface fresh/brackish and underlying seawater layers flowing in opposite directions (see Scheme 1). Between the two layers, a velocity shear is formed, which induces a progressive increase in salinity (and transport of elements) of the overlying brackish layer, and the movement of the upper edge of seawater toward the sea (Legović, 1991). As the energy of water in stratified estuaries is not high, the diffusional and convective upward and/or downward vertical transport of elements takes place. This hydrodynamic transport model was principally considered in explaining the distributions of measured parameters along the vertical and horizontal estuarine transect in the following sections.

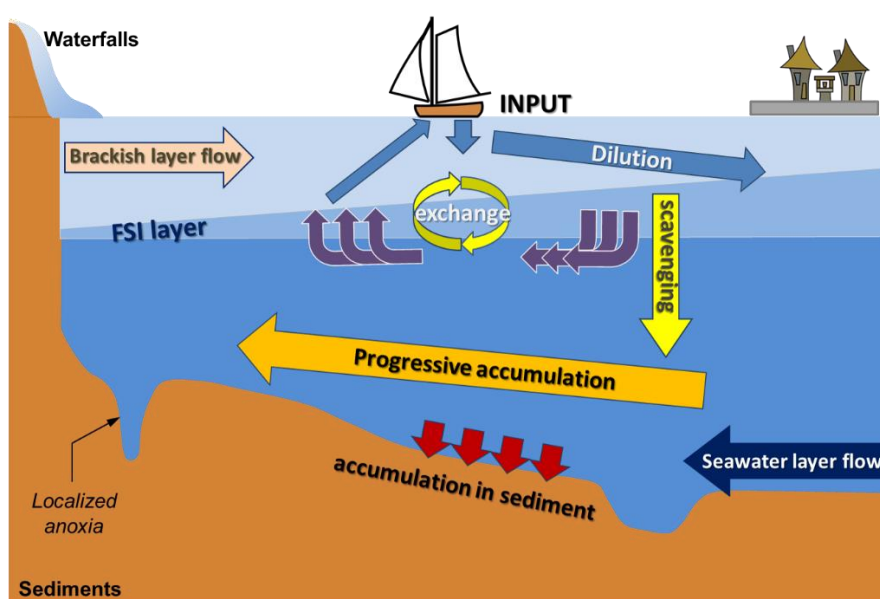

Scheme 1. Principal hydrodynamic and transport model of the Krka River estuary.

5.2. Behaviour of trace metals along the salinity gradient

The main characteristic for all measured metals is that the concentrations in the freshwater end-member are lower than in seawater (Table 5.1), both dissolved and total. This is the opposite of what is true in many other estuaries that are characterized by a high input of metals in the sea by the river (Cobelo-Garcia et al., 2004; Elbaz-Poulichet et al., 1984; Hatje et al., 2003a; Kraepiel et al., 1997; Oursel et al., 2013; Turner and Millward, 2002; Waeles et al., 2007; Waeles et al., 2008a). Due to the low SPM input, the impact of removal processes within estuarine mixing zone is diminished, making the identification of these processes (by comparison of the theoretical dilution curve and the actual concentrations) much more complicated (Dortch et al., 1991; Elbaz-Poulichet et al., 1991; Fu et al., 2013). In line with this, as the particulate fraction is low, the contribution of potentially released metals to the dissolved pool is also probably minor. The subsurface maximum within the FSI layer previously reported to occur for organic matter and trace metals (Bilinski et al., 2000; Kniewald et al., 1987; Louis et al., 2009; Žutić and Legović, 1987) was not registered in our study mainly due to an insufficient number of points in the vertical profile (only three points, from which only one is in the FSI layer).

Table 5.1. Average dissolved metal concentrations (in nM) in each layer for the winter/summer period and the average dissolved fraction (DF) (all samples).

Layer	Zn	Cd	Pb	Cu	Ni	Co
Brackish	6.7/7.7	0.052/0.060	0.042/0.074	3.9/11.3	3.7/5.5	0.33/0.38
FSI	7.5/8.5	0.076/0.071	0.055/0.098	4.4/10.2	5.1/6.3	0.36/0.41
Seawater	7.0/8.6	0.081/0.080	0.108/0.118	4.0/5.7	6.4/7.8	0.30/0.51
DF (%)	87/68	93/91	52/36	90/84	92/91	92/83

Shortly, with the exception of Pb, a general characteristic of all other metals is a very high average degree of dissolved fraction (DF; see Table 5.1). The average dissolved fraction was slightly smaller in summer than in winter, which is probably more a consequence of the different type of SPM (more of biogenic origin), than its concentration.

5.2.1 Zinc (Zn)

Distributions of dissolved Zn in relation to salinity and distance along the estuary transect for the winter and the summer period and for each layer are presented in Fig. 5.1. In the surface brackish layer, Zn exhibited a highly positive deviation from the theoretical dilution

line for both periods, indicating an additional supply of Zn. As expected, for both sampling periods the highest concentrations were measured in samples collected in the Šibenik bay. However, observing the same level of Zn in the winter as for the summer period (~ 15 nM) was unexpected, despite the fact that there are decreased activities (touristic) in the winter period. This implies that there is a “continuous” supply of Zn in the surface layer. Except nautical marina located within the Šibenik bay, “diffusive” inputs of communal waters from the town probably take place (despite the fact that the majority of waste water is channelized to a new collector). While for the winter campaign (Fig. 6, left plots), Zn concentration increased progressively from ~ 2 nM at the freshwater end-member up to 15 nM at the Šibenik bay, and then decreased seaward, reaching ~ 3 nM at the seawater end-member, in the summer period (Fig. 5.1, right plots), an additional increase of Zn was observed at the 5th km. This increase is attributed to the intensive touristic activities in summer, especially related to a large number of boats anchored in front of the Skradin town and entrance to the National park.

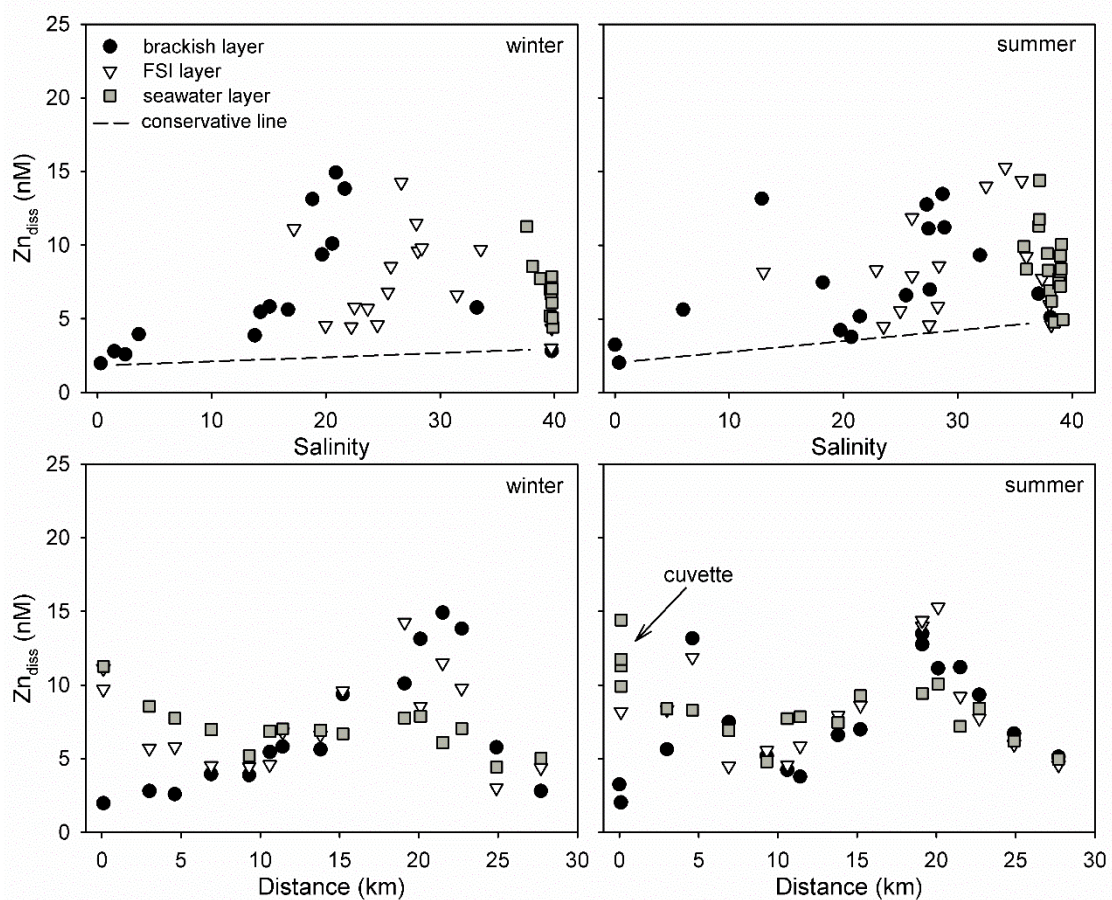

Figure 5.1. Distribution of dissolved Zn concentrations in relation to salinity and distance for the three layers, in the winter and summer period. The dashed line represents the theoretical dilution line.

5. Discussion

Considering the magnitude of the estuary spatial scale, the mentioned Zn supply in the surface layer could be considered point-source inputs. A point source contamination input in rivers is normally distributed only in the downstream direction. However, although the surface layer in the Krka River estuary is flowing downstream, the observed “pyramidal” distribution of Zn in the surface layer could only be justified if a two-directional transport model (described in section 5.1.) is respected. Thus, considering the point-source supply in the Šibenik Bay, Zn is transported in a downward (vertical) and seaward (horizontal) direction. In the seaward direction, a near-linear decay with the salinity could be drawn (Fig. 5.1), indicating quasi-conservative behaviour (considering the seawater end-member). The progressive decrease of Zn concentrations was also observed in the upstream direction. However, the concentration is decreasing more rapidly as salinity declines, pointing to a non-conservative behaviour (regarding the freshwater end-member). The described hydrodynamic transport model assumes that the seawater layer is progressively enriched by Zn (with a decreasing vertical gradient). An enrichment of the seawater layer is mainly the consequence of a vertical transport (i.e. settling) of Zn from the contaminated zone and its progressive accumulation, amplified by the longer residence time of the seawater flowing upstream. By an upstream seawater flow, a mixing of the two layers leads to an increase in Zn in the surface layer, while the concentration in the halocline is generally between these two boundaries, i.e. the same behaviour as observed as for SPM. The same trends were also obtained for the Zn “concentration peak” observed in the summer at the 5th km. In both cases, a sharper decrease of Zn concentration in the upstream direction compared to the downstream direction is logical and is a consequence of the partial Zn removal, as well as the dilution within the seawater layer. The vertical transport of Zn supplied in the surface layer was reflected along the vertical column, yielding a “concentration peak” in the other two layers at the source site (KE-10, KE-11).

For both campaigns, an upstream increase of Zn was observed in the seawater layer (Fig. 5.1, grey squares). The intensity and the shape of these spatial distributions are a “net” result of several physico-chemical parameters and processes. The residence time of the seawater layer increases in the upstream direction, which in combination with a continuous supply and a low removal from the water column (low Zn particulate fraction), produces a progressive accumulation and an upstream increase of Zn concentration, leading to ~5× higher concentration of Zn in the seawater layer than in the freshwater layer at the first

sampling point (KE-1). Compared to the seawater end-member, the concentration in the seawater layer increased about 3 times for both the winter and the summer period.

5.2.2 Cadmium (Cd)

Dissolved Cd concentration in the surface brackish layer showed an increasing trend with increasing salinity for both periods: from ~0.010 nM in the freshwater, to ~0.070 nM in the seawater end-member, respectively (Fig. 5.2). Along the salinity gradient, most of the values are above the theoretical dilution line, indicating a non-conservative behaviour. Commonly, this behaviour is ascribed to the competitive effect of the chloride ions, i.e. release of dissolved Cd from the SPM into solution as a result of the formation of stable chloro-complexes (Elbaz-Poulichet et al., 1996; Elbaz-Poulichet et al., 1991; Kraepiel et al., 1997; Oursel et al., 2013; Waeles et al., 2005). Although such behaviour is consistent with other studies, in most of these studies that reported non-conservative Cd behaviour in estuarine mixing, the concentration of SPM was much higher than in our case, and the distribution is characterised by the “concentration peak” appearing mainly at salinities between 10 and 20 (Dabrin et al., 2013; Elbaz-Poulichet et al., 1996; Elbaz-Poulichet et al., 1987; Fu et al., 2013; Hatje et al., 2003a; Kraepiel et al., 1997; Oursel et al., 2013; Oursel et al., 2014; Paucot and Wollast, 1997; Waeles et al., 2005; Waeles et al., 2004). As the particulate concentration of Cd measured in the freshwater end-member is very low (<10%), the release of Cd from SPM is excluded as a main contributor to the observed trends in the Krka River estuary (although it can contribute partly to the overall increase). For both the winter and the summer period, the highest concentrations of Cd were measured in the Šibenik bay (~20th km), which is consistent with the results of high-resolution mapping within the bay (section 4.3.2). Thus, the observed non-conservative behaviour of Cd is primarily ascribed to the point-source input, and could be explained by the seaward/landward redistribution by the transport mechanism previously described for Zn. The similar trend of Cd with salinity obtained in previous study with smaller number of sites was defined as “near-conservative” (Elbaz-Poulichet et al., 1991).

Compared to Zn, a lower anthropogenic “concentration peak” within the Šibenik bay was obtained due to the much lower relative Cd contribution to the system. No significant difference between winter and summer Cd spatial distributions in the surface brackish layer was found for most of the estuarine transects. This is consistent to the fact that probably most of the Cd pollution is related to phosphate ore "production" which is not as seasonal as

5. Discussion

nautical activities. Slightly higher (~30%) Cd concentrations measured in summer in the Šibenik bay are probably a consequence of more intensive activities within the harbour, which was identified as the main source. However, this increase is too small to be “measurably” reflected at more downstream/upstream locations.

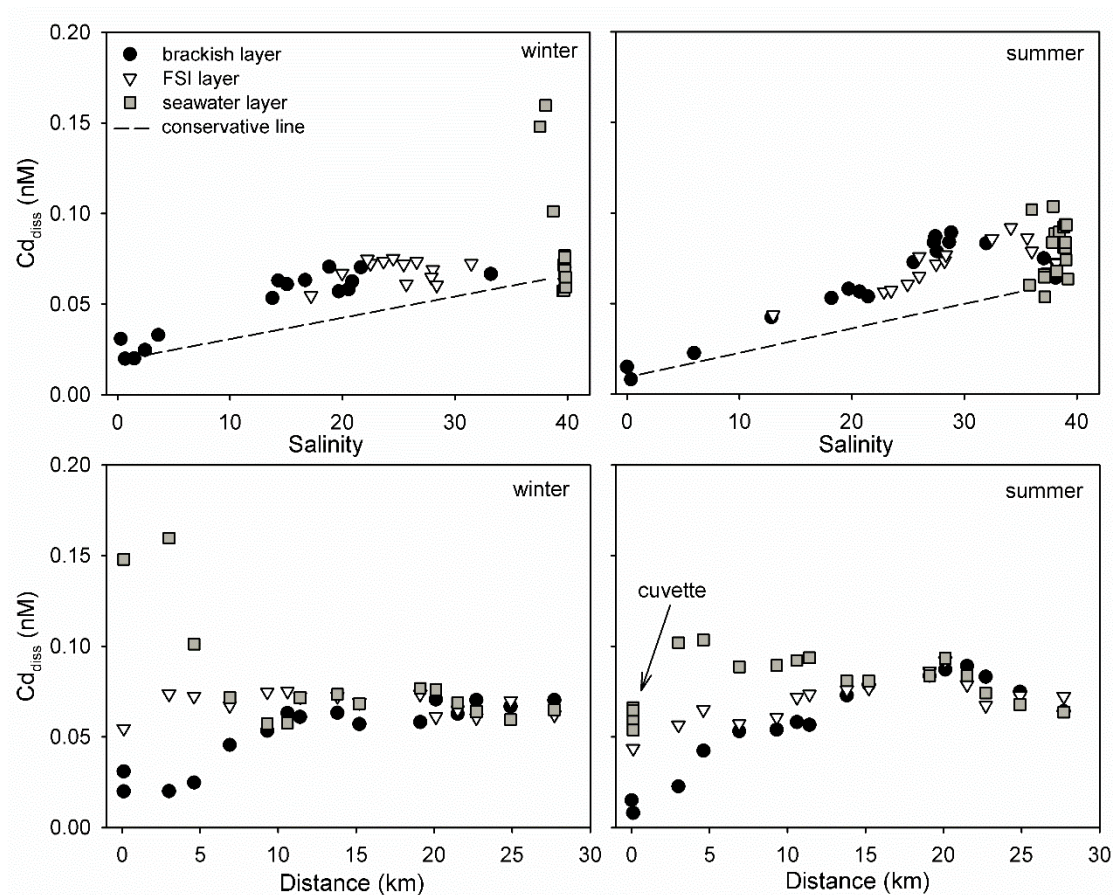

Figure 5.2. Distribution of dissolved Cd concentrations in relation to salinity and distance for the three layers, in the winter and summer period. The dashed line represents the theoretical dilution line.

As for Zn, an upstream increase of Cd concentration in the seawater layer was registered. The shape of the concentration increase follows that of Zn for the majority of transect, despite a relatively smaller contribution of anthropogenic Cd from the upper layers. For the winter period, a very strong upstream increase ($\sim 3\times$) of Cd, starting upstream of the $\sim 10^{\text{th}}$ km (site KE-4) was measured. The same relative increase was found also for Co. Currently, we do not have a reasonable physico-chemical explanation/scenario which would lead to such a strong increase in concentration of these two metals, other than that the increase is a consequence of the progressive accumulation accompanied with the absence of removal processes which do not occur in “old” seawater (as is the case for Pb). This scenario might

be partly supported by the observed trend in particulate fractions of metals, which is the lowest for Cd and Co. A more detailed study would be needed in order to fully explain this observation.

Contrary to the winter period which is characterised by a strong increase, a drop of Cd in the seawater layer in the summer period was recorded at the first sampling site (KE-1). This site is characterised by the cuvette, where anoxic conditions occurred. Anoxic conditions favour the reduction of sulphate to sulphide (Rigaud et al., 2013), leading to the formation of strong metal-sulfide complexes. The same concentration drop is also observed for Cu, while other metals showed either an increase (Zn, Co) or no significant (Pb, Ni) change in concentration. The formation of CdS precipitates was recently found to control the vertical distribution of dissolved Cd in oceans at depths characterized by the oxygen-deficient zones (ODZ) (Janssen et al., 2014). In our case, both dissolved and particulate fractions of Cd and Cu dropped at this location. As the depth range of the seawater layer at this location is relatively thin (~3 m), a potentially formed sulphide precipitate was already removed from the water column at the time of sampling, and thus the drop of both concentrations occurred. Another possibility which should not be excluded as a possible explanation of the observed concentration drop is related to the analytical procedure of metal determination. Namely, the determination of dissolved/total metals include acidification to a pH of < 2 and UV-light digestion of samples in order to destroy residual organic matter which could interfere with the measurement. There is a possibility that the formed CdS and CuS complexes, if not dissociated by the acidification, were not transformed to the measurable species by the applied electrochemical method and remained “invisible”. Among the measured metals, the highest sulphide stability constants in seawater were found for Cd and Cu (Al-Farawati and van den Berg, 1999), which could partly justify the second scenario (Jiann et al., 2005). A more detailed study is needed in order to explain this observation.

5.2.3 Lead (Pb)

The same trends of dissolved Pb in the surface brackish layer in relation to salinity and distance were observed for the winter and summer period (Fig. 5.3). As for all other metals, the concentration of dissolved Pb increased in the seaward direction from ~0.020 to ~0.050 nM, but showed in general a strong positive deviation from the theoretical dilution line. However, if examined by separate segments, almost conservative behaviour for Pb was maintained up to the ~15th km for the summer period, whereas a negative decline from the

5. Discussion

dilution line is obvious for the first ~10 km in the winter period. Although of a very small absolute intensity, this decline could be attributed to the removal of Pb, often explained by rapid sorption of dissolved Pb onto re-suspended particles and/or co-precipitation with iron and manganese oxides (Elbaz-Poulichet et al., 1984; Fu et al., 2013; Ouseph, 1992; Waeles et al., 2007; Waeles et al., 2008b). In the summer period this decline was not observed probably due to the different average nature of SPM and/or steady state equilibrium between the Pb input and removal from the layer. The positive deviation from the dilution line at more downstream sites for both periods is primarily caused by the additional anthropogenic input of Pb within the Šibenik bay. Similar trends of Pb distribution in the surface layer were noticed in the previous study (Elbaz-Poulichet et al., 1991). The shape of the pyramidal Pb concentration peak could be generally explained as was for Zn and Cd, and will be not repeated here.

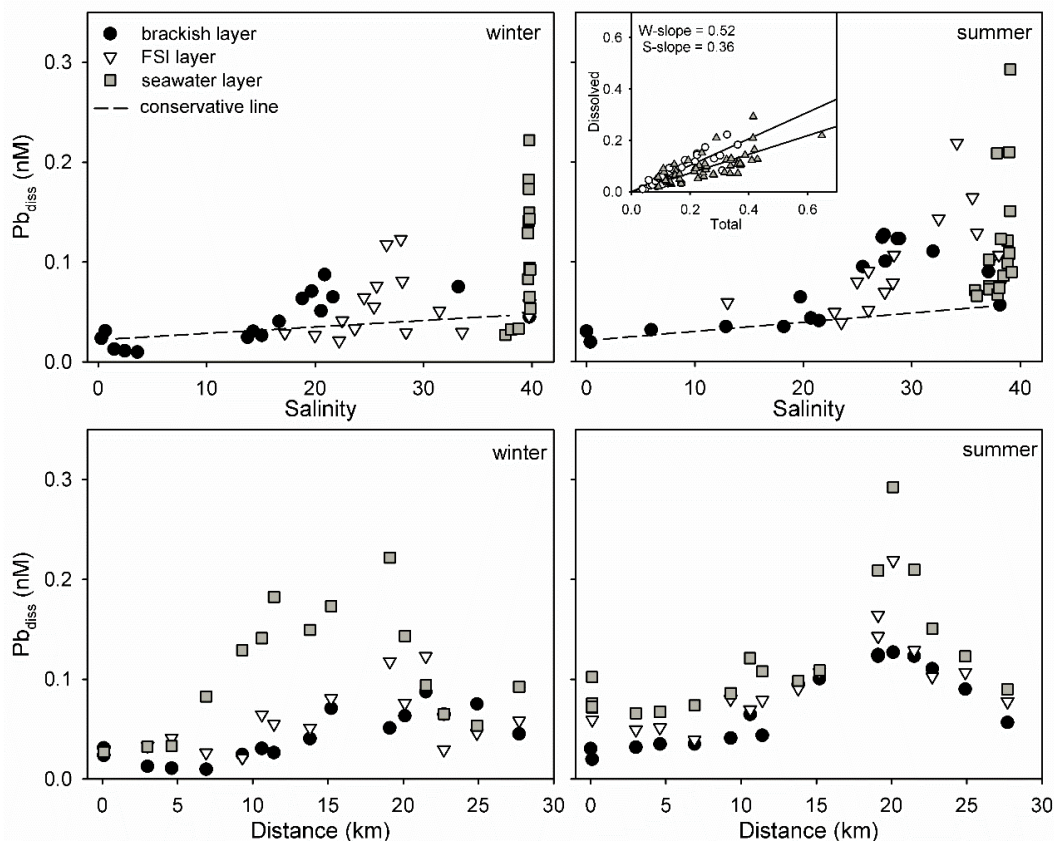

Figure 5.3. Distribution of dissolved Pb concentrations in relation to salinity and distance for the three layers, in the winter and summer period. The dashed line represents the theoretical dilution line. Inset: Relationship of dissolved vs. total Pb for the winter (W, empty circles) and summer (S, grey triangles) period.

One of the particularities which characterise Pb distribution is a systematically high concentration increase with depth at almost all sites (much more expressed in the winter than

in the summer), and an absence of continuous upstream concentration increase in the seawater layer, the behaviour observed for all other metals. Compared to other metals, Pb is known as the particle-reactive metal. While the dissolved fractions for most of the metals were quasi-constant along the estuary in all three layers (>80%), the dissolved fraction of Pb varied from ~20% at the most upstream site, to ~80% at the seawater end-member (Fig. 5.4) for all three layers. The observed trends could not be ascribed exclusively to the change in SPM concentration, but also to the type of SPM (and potentially to the Pb:SPM ratio). This could be clearly demonstrated using values obtained at the most upstream sites in winter: while similar dissolved fractions in brackish and seawater layers (~30-40%) were found, a tenfold difference in SPM concentrations was measured.

In the study performed by Elbaz-Poulichet et al., the concentration of Pb in the seawater layer “continuously” increased in a landward direction (based on 4 locations), reaching the highest value at the most upstream site (KE-3 in our case, 5th km). Profiles obtained in our study showed completely different behaviour: while an increase of Pb was recorded starting from the seawater end-member with the maximum within the Šibenik bay, a decrease in Pb concentration was registered thereafter in the landward direction, reaching a Pb concentration at the most upstream sites, smaller than those found in the seawater end-member. This clearly indicates that the removal processes control the content and distribution of Pb in more upstream parts, commonly explained by Pb scavenging by Mn and Fe oxyhydroxide (Elbaz-Poulichet et al., 1984; Turner and Millward, 2002; Waeles et al., 2008b), a process usually observed in open ocean waters. As Mn and Fe concentrations were not measured in this study, we cannot confirm that this removal process is dominating. However, taking into account that a very high correlation factor (CF = 0.941, n = 13, p = 95%) between Pb and Mn was found across the estuary transect (Cukrov et al., 2008b) and that high concentrations of Mn and Mn-particles were measured in the estuary zone in the vicinity of the former ferro-manganese factory (Bilinski et al., 1996; Omanović et al., 2006), this assumption seems reasonable in our case as well. The increased Pb concentration in the seawater layer is more pronounced and also extended in the winter (up to the 5th km) than in the summer period (up to the 10th/15th km), despite the average level of Pb being higher in summer. This could be explained by the faster settling rate in summer linked to a different nature of suspended particles, which is also supported by the higher particulate fraction in summer (see inset in Fig. 5.3), as well as the “energy” of water related to a longer residence time (Legović, 1991). An increase in dissolved (and total) Pb with depth is a consequence

5. Discussion

of the accumulation of Pb that has sunk from the surface layer, while its spatial distribution within the seawater layer is a net result of the above mentioned processes affecting distribution between the particulate and dissolved phase. However, the sediment should not be discarded as a possible additional source of Pb due to numerous biogeochemical processes within the sediments and at the sediment/water interface (SWI) (Cobelo-Garcia and Prego, 2004; Dang et al., 2014; Lourino-Cabana et al., 2011; Martino et al., 2002; Rigaud et al., 2013). The most recent information from the media (July 2014) is that there is an army shipwreck at the entrance of the Šibenik bay (site KE-11), which sank at the end of the 2nd world war. As in that time Pb was used as an antifouling paint and as such torpedo-boats were equipped with Pb-batteries, there is a possibility that some portion of increased Pb in the seawater layer originates from that source. Moreover, an open question remains about the contribution of Pb released from the lost Pb fishing-weights deposited at the sediment, which was documented by the diver to be heavily spread at the “fishing” locations within the bay.

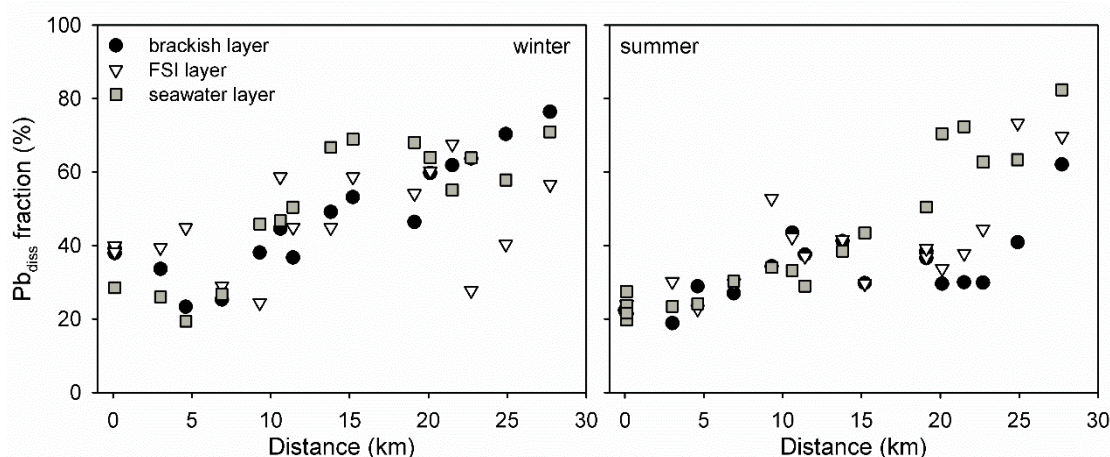

Figure 5.4. Distribution of dissolved Pb fraction in relation to distance for the three layers, in the winter and summer period.

5.2.4. Copper (Cu)

Among the measured metals, the most variable spatio-temporal distributions along the estuary transect were found for both dissolved and total Cu concentrations (Fig. 5.5). Considering the concentrations of end-members, only slightly higher concentrations (in absolute values) were measured in seawater samples (~2.2 nM vs. ~3.3 nM), similar to as was previously measured by Louis et al. (2.7 nM vs. 4.0 nM) (Louis et al., 2009a) and Elbaz-Poulichet et al. (1.8 nM vs. 4.4 nM) (Elbaz-Poulichet et al., 1991). In addition, the difference between winter and summer end-member samples was also minor. In contrast to these

similarities, the dissolved concentrations exhibited quite different inter-estuarine distributions for the winter and summer campaigns, especially pronounced for the surface and the FSI layers. With increasing salinity a positive deviation from the conservative line was a general characteristic for both periods. The maximal level (~7 nM), and a common trend in the winter period, agree with those measured by Elbaz-Poulichet in May of 1988 (Elbaz-Poulichet et al., 1991). In both studies, the highest concentrations, ascribed to “regular” anthropogenic input, were measured in the Šibenik bay. However, while in the 1988 study the main source of Cu was likely the contaminated untreated waste water discharged within the bay, in our study, the increased Cu originates primarily from the antifouling paints of the boats, located in the nautical marina, harbour and along the costal line of the Šibenik town. About a three-fold increase in the Cu concentration, compared to the end-members, was registered (winter period). A direct comparison with other estuaries is not as straightforward as both the conservative (Abe et al., 2003; Elbaz-Poulichet et al., 1996; Fu et al., 2013; Koshikawa et al., 2007; Waeles et al., 2009) and the non-conservative (Hatje et al., 2003a; Waeles et al., 2008b) dissolved Cu distributions observed. A non-conservative behaviour observed in our, but also in many other estuaries, is attributed to additional, usually point-source, anthropogenic inputs. As presented for other metals, a vertical and horizontal redistribution of supplied Cu takes place in both the seaward and landward directions, producing a characteristic “concentration peak” in the brackish and the FSI layer (Fig. 5.5).

A strong increase of dissolved Cu within the inter-estuarine transect was observed in summer (Fig. 5.5), as was similarly shown previously for dissolved Zn. The two “hot-spots”, located at the 5th km (Skradin village) and the 20th km (Šibenik bay) can be easily distinguished. Compared to the winter period, dissolved Cu increased threefold (up to ~20 nM) in the Šibenik bay, whereas at a more upstream site (south entrance to the National park) a sevenfold (~15 nM) increase occurred. Increased Cu concentrations in the summer period are primarily the result of intensive touristic activities, i.e. nautical traffic of pleasure/recreational boats. The exact intensity of nautical traffic (number of passing boats) is unknown for the period of sampling, however our recent video monitoring survey conducted in 2014 (data not shown) showed an exponential increase of boats in the period from January to August (approximately a tenfold increase). At the summer season peak (July/August), between 500 and 1500 boats (depending on weather conditions) pass across the estuary every day. As the majority of boats is protected by antifouling paints containing

5. Discussion

Cu as an active biocide component, it is not surprising that such a high increase of its concentration occurred in surface layer. Due to the unknown number of boats, their average size/area and the duration of their stay within the estuary, it is not possible to calculate the total amount of Cu released this way.

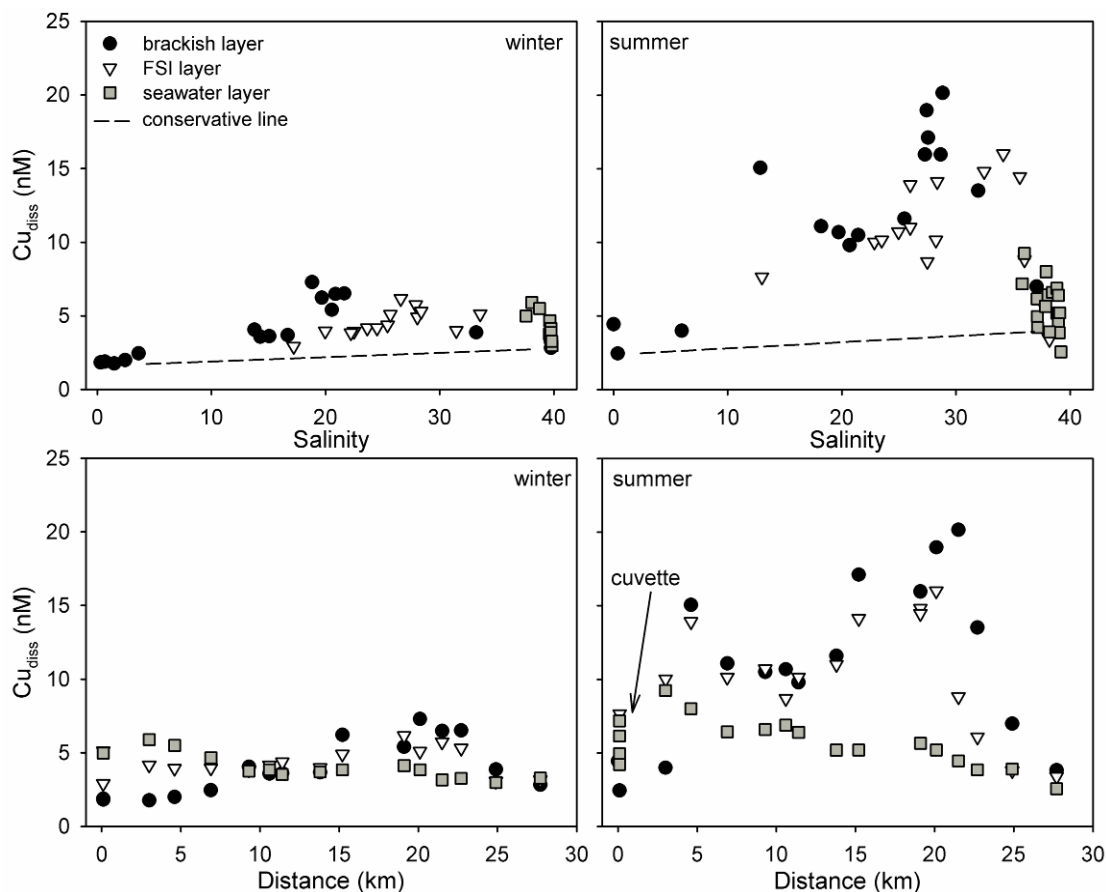

Figure 5.5. Distribution of dissolved Cu concentrations in relation to salinity and distance for the three layers, in winter and summer period. Dashed line represents theoretical dilution line.

Although Cu is highlighted as the main biocide component ($\sim 300 \text{ mg g}^{-1}$ of Cu), antifouling paints also contain high concentrations of Zn ($\sim 100 \text{ mg g}^{-1}$ of Zn) (Singh and Turner, 2009b). While both Cu and Zn showed two “concentration” peaks in the summer period (at the 5th and 20th km), an interesting question is the question of persistency of high Zn concentrations in the Šibenik bay. This occurrence could also be expressed as the absence of the additional Zn increase in summer at that position. As previously mentioned, the persistency of a high Zn concentration could be explained by the high continuous input of Zn throughout the whole year, outstripping the input by the boats, while the other hypothesis (expressed as the

absence of a Zn increase in summer) could be linked to the chemistry of Zn release in relation to salinity. Namely, Sing and Turner (2009a) showed that the release of Cu increases with salinity, whereas the dissolution of Zn strongly decreases (Singh and Turner, 2009a). Although the observed concentration maximum in our study appeared at much higher salinities (20-30) compared to the range of the highest Zn dissolution decrease (0-10), in combination with the temperature and concentration of organic matter (Neira et al., 2009; Singh and Turner, 2009a), these hypotheses are worth the consideration in potential further studies.

As observed for some other metals, dissolved Cu concentrations in the seawater layer increased continuously in the upstream (landward) direction as a result of the progressive accumulation of Cu. The higher increase observed in summer (~threefold increase compared to the seawater end-member) compared to in winter (twofold) was expected due to the higher contribution of Cu from the surface layer by downward vertical transport. A decrease of Cu in the cuvette (Fig. 5.5) at the first site (KE-1) in summer, already discussed along with Cd behaviour, could be related to the occurrence of anoxic conditions and the likely formation of sulphide precipitates.

5.2.5. Nickel (Ni)

Among the examined metals, only dissolved Ni concentrations followed nearly-conservative behaviour with the salinity (Fig. 5.6). Starting with ~2 nM at the freshwater end-member, dissolved Ni increased up to ~6 nM in winter, and ~8 nM in summer, at the seawater end-member. This concentration range fully agrees with that measured by Elbaz-Poulichet in May, 1988 (Elbaz-Poulichet et al., 1991). A good agreement with the theoretical dilution line is consistent with the observed stable distribution of Ni concentrations within the Šibenik bay, i.e. absence of anthropogenic input. Both conservative (Elbaz-Poulichet et al., 1996; Elbaz-Poulichet et al., 1991; Fu et al., 2013; Hatje et al., 2003a; Paucot and Wollast, 1997) and non-conservative behaviour of Ni in the salinity gradient was reported in the literature (Koshikawa et al., 2007; Oursel et al., 2013). Vertical concentration profiles of Ni follow the horizontal one, i.e. the concentration increases with the depth (salinity). The typical upstream increase of metal concentrations in the seawater layer was also observed for Ni.

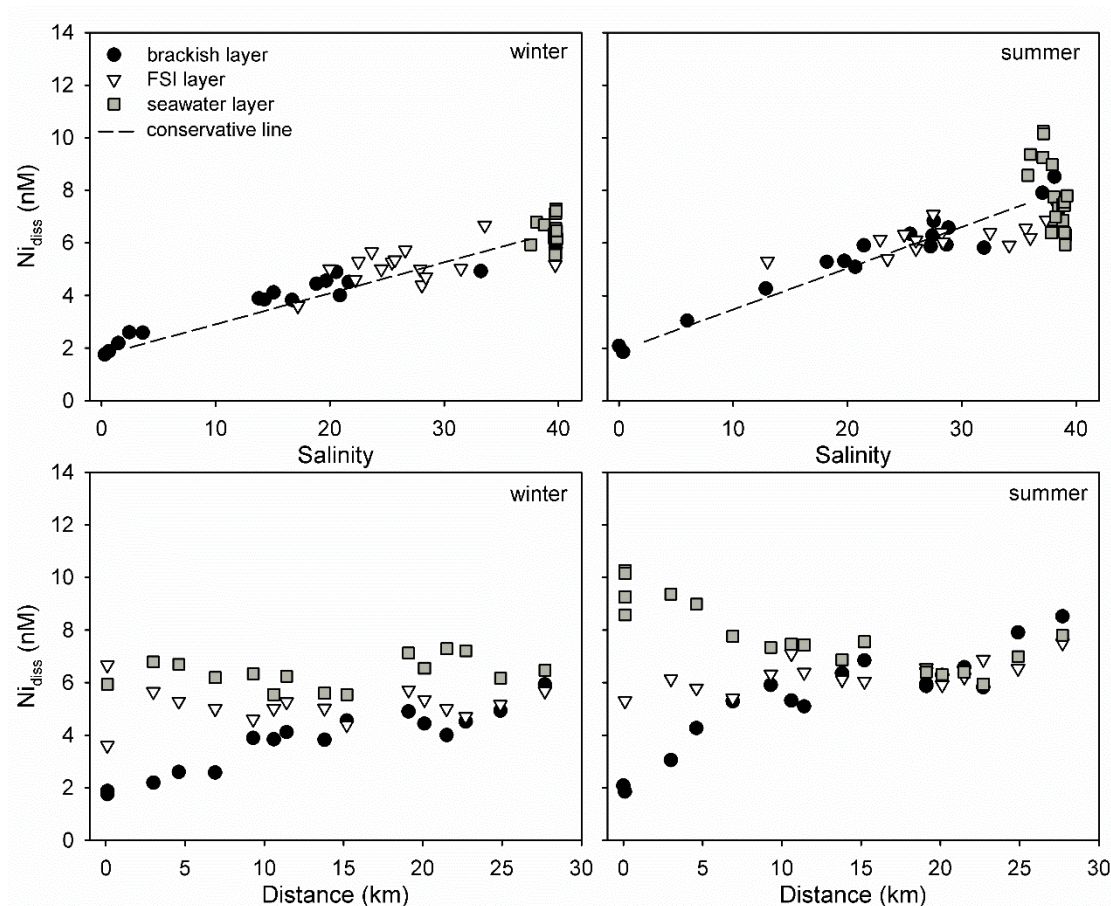

Figure 5.6. Distribution of dissolved Ni concentrations in relation to salinity and distance for the three layers, in the winter and summer period. The dashed line represents theoretical dilution.

5.2.6. Cobalt (Co)

Horizontal profiles of dissolved Co showed less defined profiles compared to the other metals (Fig. 5.7). While in winter, the concentration in the freshwater end-member (~ 0.3 nM) was higher than in the seawater end-member (~ 0.2 nM), a higher level of dissolved Co (~ 0.4 nM) was measured in summer in the seawater end-member. A positive deviation from the theoretical dilution line was observed in winter. Release of dissolved Co was also observed in mixing zones in studies of other authors (Oursel et al., 2013; Takata et al., 2010). However, a positive deviation up to a salinity of 25 in summer was followed by a negative one (Fu et al., 2013), showing the complex behaviour of Co. As for Ni, there is no additional anthropogenic input of Co in the Šibenik bay.

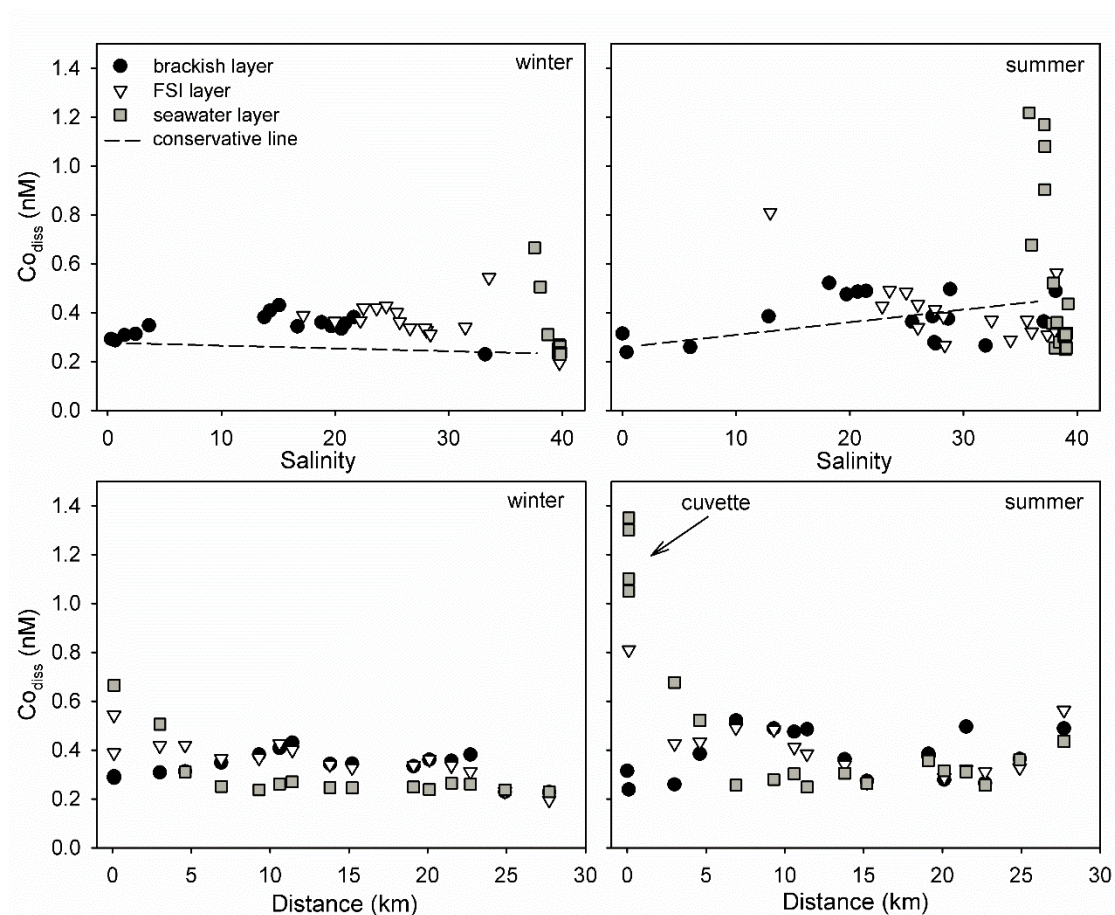

Figure 5.7. Distribution of dissolved Co concentrations in relation to salinity and distance for the three layers, in the winter and summer period. The dashed line represents theoretical dilution line.

Both the winter and the summer horizontal profiles of dissolved Co in the seawater layer are characterized by a strong upstream increase. This increase is most probably associated with the combined effect of the release of dissolved Co from the settled particulate matter and upstream progressive accumulation in the seawater layer, having a longer residence time (longer in summer than in winter). Contrary to Cd and Cu for which a decrease of concentration with depth in the “cuvette” at the first site (KE-1) was observed, dissolved Co greatly increased. The increase of Co concentration in the “cuvette” is coupled with an increase of its dissolved Co fraction (88% average in cuvette vs. 77% average for stations 2 to 5). Such behaviour could be related to the link between Co and Mn cycles, i.e. remobilisation of Co due to the reduction of settled MnO_2 -containing particles as previously reported in hypoxic-anoxic waters (Canavan et al., 2007; Rigaud et al., 2013). Additional studies will be required to validate this observation.

5.3. Partitioning of trace metals

With the exception of Pb which was described earlier in the text, concentrations of trace metals in particulate fraction are below 20% in most of the samples (Fig. 5.8). Slightly higher average particulate fractions obtained in summer samples are mainly the consequence of the differences in SPM nature (more biogenic). Due to the relatively low total quantity, any release of metals from particles to the dissolved phase in the salinity gradient would hardly be noticeable if sample treatment as well as the accuracy and precision of the analytical technique were not “ideal”.

The particle-water distribution coefficients (K_D) is an empirical term commonly used to describe solid-solution interactions, i.e. in combination with SPM, it explains the role of particles in trace element behaviour in the solution:

$$K_D = \frac{c_{part}}{SPM \times c_{diss}} (L kg^{-1}),$$

where c_{part} and c_{diss} are metal concentrations in particulate and dissolved form, respectively, while SPM is concentration of suspended material.

As it depends on many factors (e.g. solution and particle composition, speciation, DOC and SPM concentration, pH, temperature, salinity), a large variation could be expected in systems that undergo different physico-chemical changes, implying that the justification of K_D variation should be taken with caution (Bourg, 1987; Cobelo-Garcia et al., 2004; Comans and Vandijk, 1988; Elbaz-Poulichet et al., 1996; Fu et al., 2013; Hatje et al., 2003b; Turner, 1996). The direct comparison of results within different studies is thus not always straightforward. In addition, differences in K_D could also be derived by the applied analytical/procedural methodologies (total digestion vs. acid leaching). An acid leachable methodology which was applied in the present case was found to better suit the overall behaviour of elements in the salinity gradient, because this fraction of metals could be considered potentially exchangeable (Elbaz-Poulichet et al., 1996), contrary to the total digestion method which extracts metals from the particle lattice.

At the level of metals measured in the estuary, the uncertainty of applied analytical techniques is usually up to 10%. Thus it is reasonable to expect relatively high uncertainties in parameters related to particulate fraction, such as the distribution coefficient K_D . As was already mentioned above, K_D depends on various parameters. Consequently, taking into account that our data covers two contrasting periods of the year, a large salinity range and

different physico-chemical characteristics of each separate layer, the wide range of $\log K_D$ values obtained in our work was in a way expected.

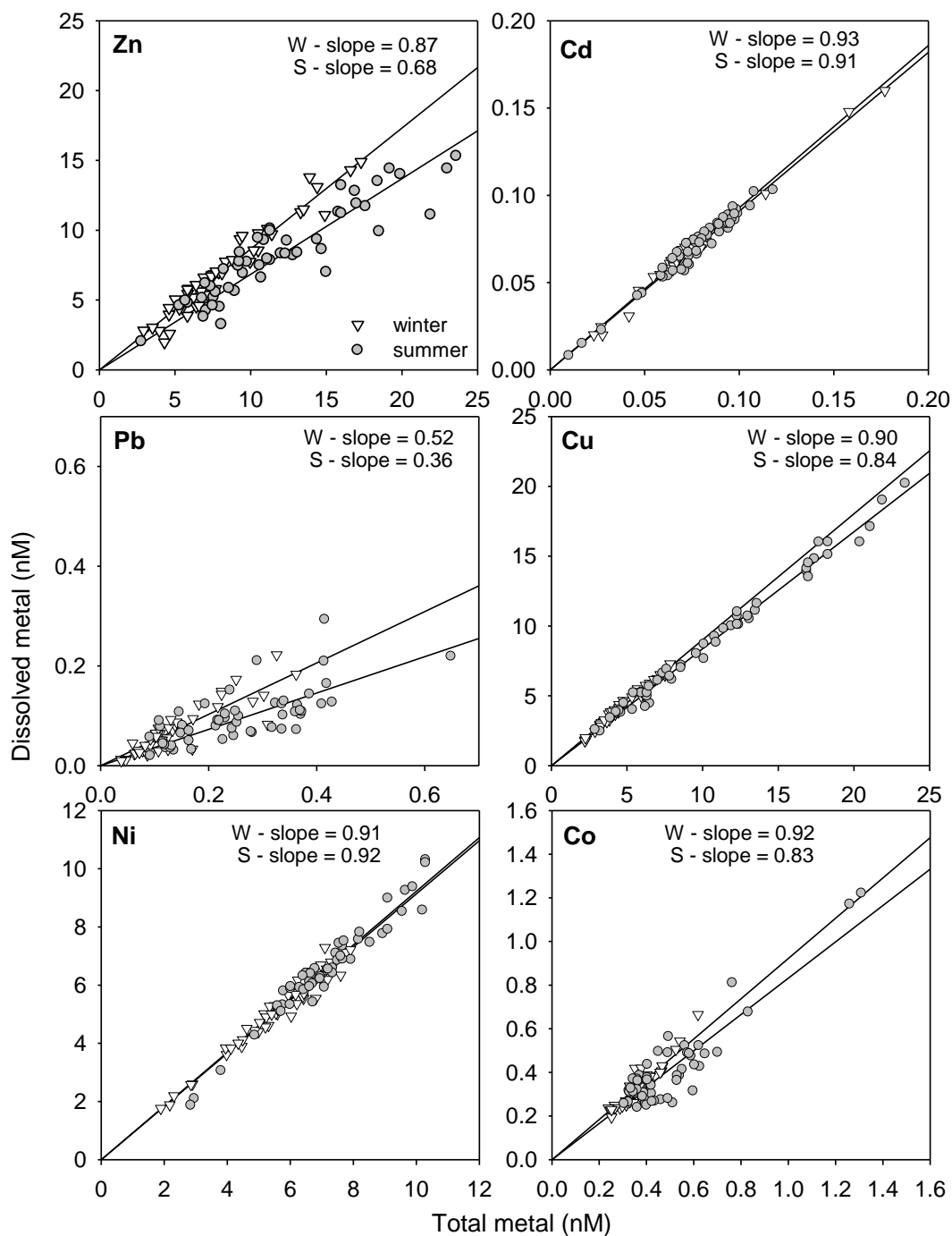

Figure 5.8. Relationships of dissolved vs. total metal concentrations for winter (W) and summer (S) period (all three depths).

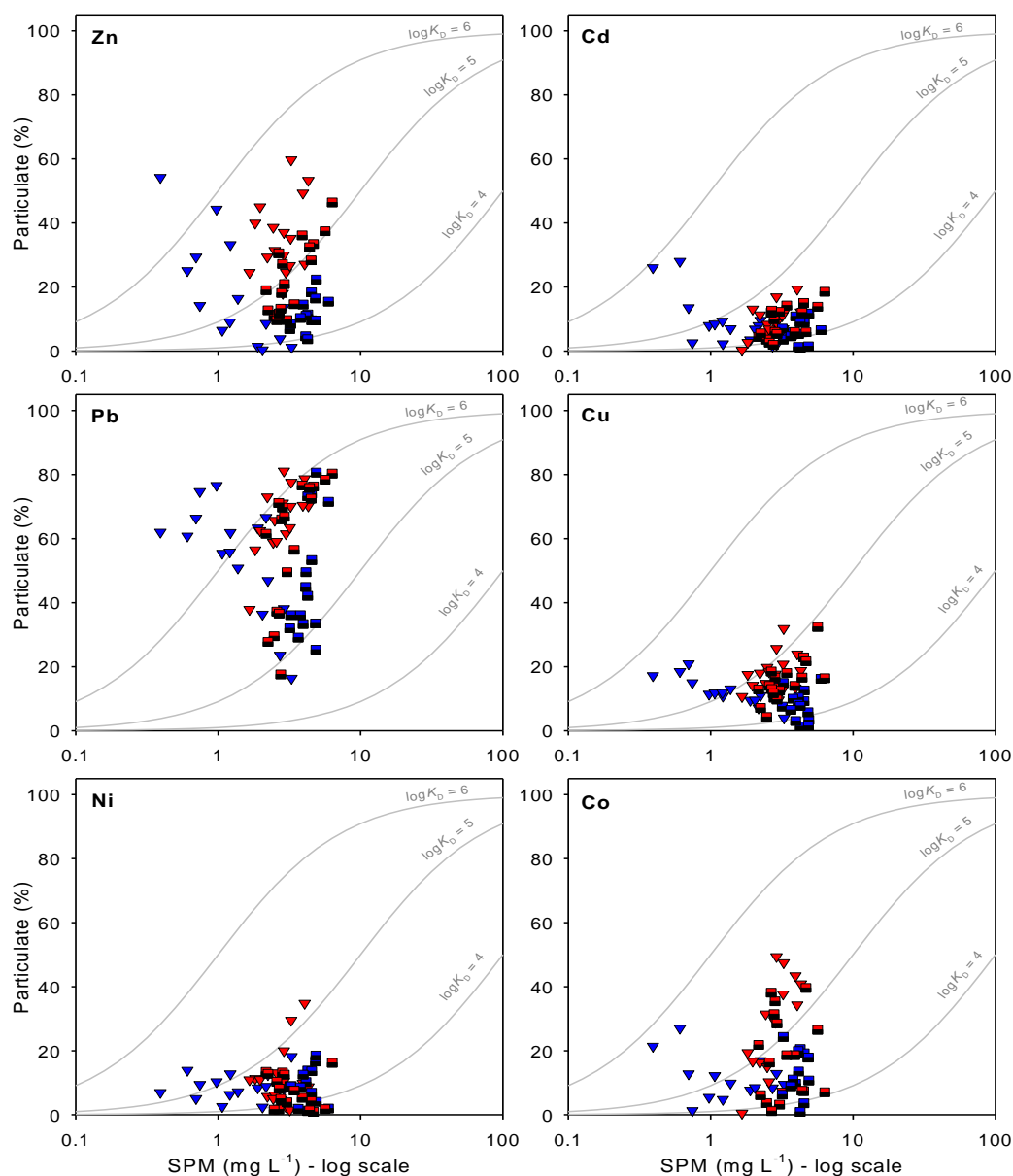

Figure 5.9. Percentage of particulate metal fraction (in total) in brackish (triangles) and seawater (squares) layer in relation to suspended particulate matter (SPM, log scale) concentrations for winter (blue) and summer (red) periods. Grey lines represent theoretical values calculated for defined $\log K_D$, as indicated on plots.

These differences could be reliably explained if the dominant source/composition of SPM is known (Deycard et al., 2014; Oursel et al., 2014b). The variability of elements partitioning related to the fluctuating K_D could be perceived by plotting the relationship of particulate metal fraction (in %) on SPM concentration along the lines representing theoretically-expected values for a defined $\log K_D$ (Deycard et al., 2014; Oursel et al., 2014b). Fig. 5.9 provides such plots for the brackish and seawater layers for the winter and summer periods.

A relatively high dispersion of values shows complexity, but also “sensitivity” of the studied estuary, in which even a small change in absolute SPM concentration can be strongly reflected in the K_D value. It should be noted, that the dispersion of data is partly caused by the propagated uncertainty in the parameter estimates due to the very low concentrations of metals and SPM.

If averaged for all samples, the order of $\log K_D$ values (Pb>Zn>Co~Cu>Ni~Cd) generally agrees with those of other authors (Chiffoleau et al., 1994; Fu et al., 2013; Hatje et al., 2003a; Munksgaard and Parry, 2001). Compared to results obtained by Fu et al. (2013) for the East Hainan estuary having similar levels of metal concentrations and SPM (Table 5.2), our values are slightly lower, indicating on average a different composition of SPM. However, rather than averaging data, it is more interesting to examine data for possible existing trends in relation to other changing parameters (e.g. SPM, salinity). Among the six possible “independent” variations of $\log K_D$ for each metal in relation to various parameters (salinity, distance, SPM), only data for the winter campaign and the brackish layer showed a well-defined tendency for all metals: a decrease of $\log K_D$ with distance, i.e. with salinity and/or an SPM increase (see below).

Table 5.2. Average values of distribution coefficient of metals ($\log K_D$).

Metal	$\log K_D$ (StdDev)			(Fu et al., 2013)
	all samples (N=98)	Winter (N=47)	Summer (N=50)	
Pb	5.69 (0.35)	5.59 (0.47)	5.73 (0.25)	5.7
Zn	4.93 (0.48)	4.74 (0.56)	5.09 (0.25)	-
Co	4.74 (0.48)	4.61 (0.44)	4.84 (0.49)	5.3
Cu	4.69 (0.36)	4.57 (0.46)	4.78 (0.16)	4.8
Ni	4.44 (0.43)	4.50 (0.41)	4.38 (0.43)	5.1
Cd	4.42 (0.42)	4.34 (0.51)	4.46 (0.30)	4.8

5.3.1. Distribution of K_D in the surface (brackish) layer

In studies by Turner and Millward (2002) (Turner and Millward, 2002) and Benoit et al. (1994) (Benoit et al., 1994), the authors provided empirical equations to describe the dependence of K_D on salinity ($K_D = K_D^\circ (S+1)^{-b}$) (where K_D° applies for the freshwater end-member) or on SPM ($\log K_D = b + m \times \log SPM$) in which data could be fitted in order to extract

5. Discussion

optimized parameters. The decline in K_D with an SPM increase observed primarily in systems with high SPM is known as the particle concentration effect (PCE) (Benoit et al., 1994), (Benoit et al., 1994; Jiann et al., 2005; Robert et al., 2004). It is not worthwhile to expect that only one parameter controls the observed behaviour, but rather a combination of different parameters (for each metal). The fact that salinity and SPM concentrations usually covariate makes the individual interpretation of the influence of each variable on the K_D distribution complicated (Hatje et al., 2003a). Thus, rather than to separately fit data in the above two equations, we calculated a theoretical relationship of $\log K_D$ vs. SPM for each metal, presuming a conservative mixing within the salinity gradient, based on the following equation:

$$K_{D,i} = \left(SPM_F \cdot \frac{S_{SW} - S_i}{S_{SW}} \cdot K_{D,F} + SPM_{SW} \cdot \frac{S_i}{S_{SW}} \cdot K_{D,SW} \right) / \left(SPM_F + S_i \cdot \frac{SPM_{SW} - SPM_F}{S_{SW}} \right),$$

where S is salinity, while subscripts “F” and “SW” denote freshwater and seawater end-members, respectively.

Positive or negative deviation from the expected theoretical curve will allow identification of additional factors controlling the partitioning of TM within the salinity gradient, i.e. between the two end-members. Fig. 5.10 shows obtained values of $\log K_D$ in relation to SPM (symbols) and calculated theoretical curves (full line). A good agreement between experimental and expected $\log K_D$ values for Pb, Cu and Ni was obtained (Fig. 5.10), indicating that the decrease of the $\log K_D$ with the SPM (e.g. salinity) is a simple result of the conservative mixing of the SPM from the two end-members, characterised by different properties towards these metals (i.e. different K_D) due to their contrast in origin/nature. Consequently, even if Cu and Pb are submitted to significant anthropogenic inputs in the Krka estuary, their dissolved/particulate partitioning is mainly controlled by the proportion and affinity of riverine vs. marine particles and less by the salinity changes. However, for Cd, Co and Zn, the majority of experimental points lie below the expected theoretical curve, pointing to additional physico-chemical processes influencing the redistribution of metals between the dissolved and particulate phase.

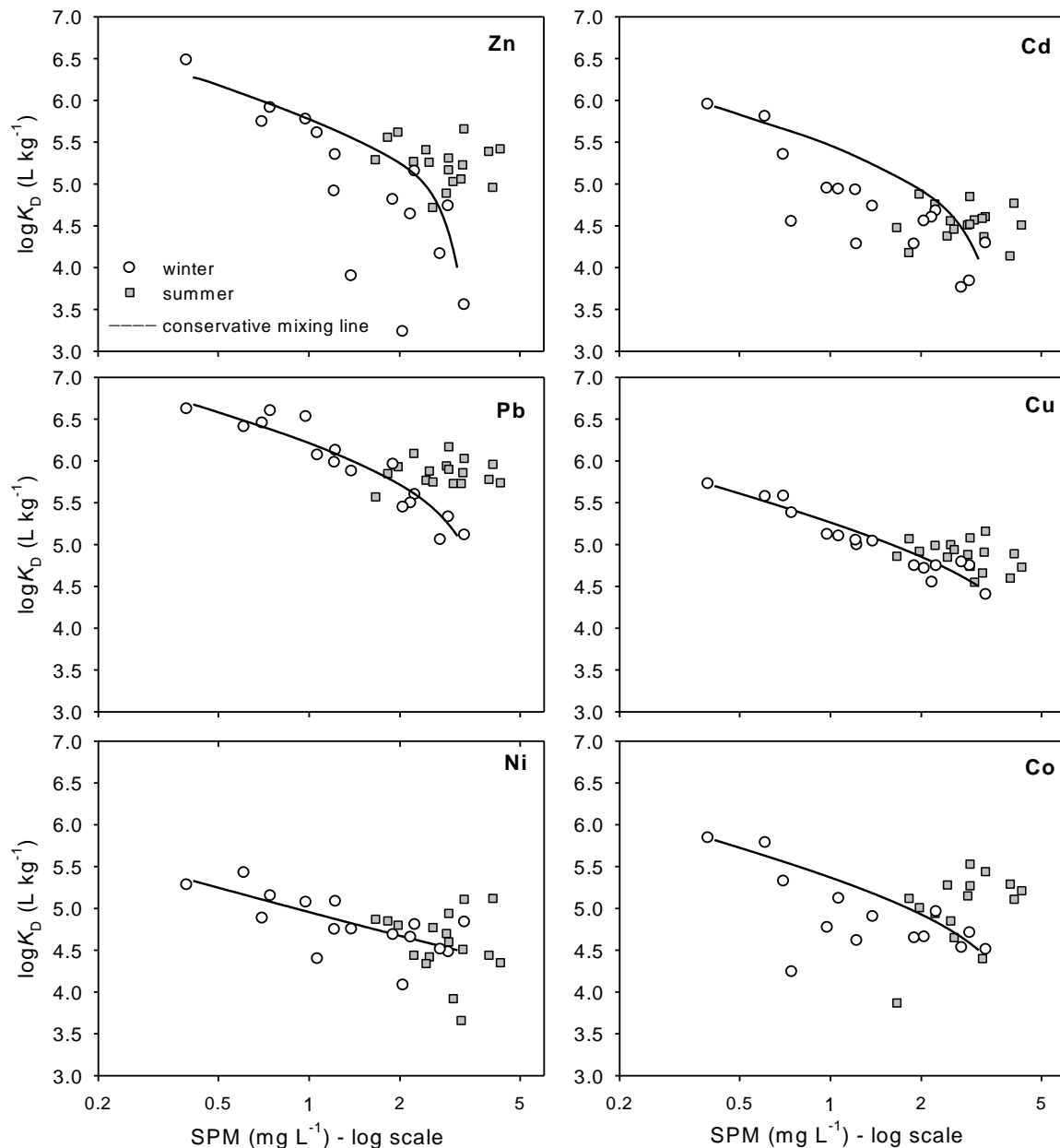

Figure 5.10. Distribution of the partition coefficient ($\log K_D$) in the brackish layer for winter (circles) and summer (squares) periods in relation to SPM. Full lines represent the theoretically-expected relationship based on the conservative mixing (see text for details).

While for Cd and for Zn such deviation could be explained by the formation of chloro-complexes (salinity and SPM positively correlate) (Hatje et al., 2003a; Waeles et al., 2005) (Dabrin et al., 2009; Deycard et al., 2014; Elbaz-Poulichet et al., 1996; Fu et al., 2013), for Co, this is less expected considering its inorganic speciation. On the contrary, no evident trends for other metals, or even an increasing trend with salinity (Fe and Pb) were found (Fu et al., 2013). Organic complexation ascribed to the decrease of $\log K_D$ of Cu (Paulson et al.,

1994) is not assumed to play a significant role in our case due to the low absolute change of DOC in the salinity gradient.

A clear distinction between freshwater- and seawater-derived SPM properties noticed in winter (independent of salinity effects) was not observed in the summer samples, which are characterized by a scattered distribution of $\log K_D$. A slightly higher average $\log K_D$ within the observed range of SPM (Fig. 5.10, squares), implies that a larger biogenic component of SPM in summer (due to the higher phytoplankton productivity, as evidenced by POC content, Fig. 4.9) increases affinity towards metals. However, a common influence of other factors/processes (e.g. analytical performance, biological uptake of metals, temperature, etc.) most probably contributed to the observed variability.

5.3.2. Distribution of K_D in the bottom (seawater) layer

Besides the previously mentioned winter trends in the brackish layer, if examined in a view of PCE, a completely opposite trend in the seawater layer in both seasons was observed for Zn and Pb (an increase of K_D with an SPM increase; data not shown). If examined according to distance, particles in the upper estuary region (longer residence time) are characterized by stronger affinities toward metals, which is clearly reflected in the partitioning of Pb and Zn. Benoit et al. (1994) related the PCE effect to the presence of Fe and Al colloids, which also caused the presence of Pb and Zn, largely in a colloidal fraction. A strong positive correlation of the particulate Pb and Zn fractions with the Fe colloids were found (Benoit et al., 1994; Dassenakis et al., 1997; Fu et al., 2013), while in addition, a positive correlation was found between particulate Pb and Mn (Admiraal et al., 1995; Dassenakis et al., 1995). Fe and Mn were not measured in our study, but as high concentrations of Mn and Fe were found in the estuary sediments (Bilinski et al., 1996; Cukrov et al., 2008b), the formation of colloidal Fe and Mn is likely to occur. Progressive accumulation of particles of biogenic origin having a larger specific surface could also explain the observed upstream increase of the K_D of Zn and Pb.

Speciation of trace metals in the Krka River estuary

CHAPTERS II and III

“*In-situ* speciation of trace metals in a vertical salinity gradient of the Krka River estuary using Diffusive Gradient in Thin Films (DGT) technique”

“Assessing Cu speciation in the Krka River estuary under different environmental and anthropogenic conditions – an electrochemical complexometric titration study”

5.4. Data quality in analytical/speciation measurements - a critical overview

The majority of studies intended to explain certain processes, behaviours, fate etc. in any of the environmental compartments (water, soils, sediments, air) rely primarily on experimental results gathered by different analytical techniques. The importance of the quality of “raw” measurement data is often underrated, leading to interpretations which do not have a solid foundation. It is commonly “accepted” that the uncertainty of analytical results of various techniques is up to 10%. However, in environmental studies, the level of analytes is often close to the limits of detection or quantification (LOD or LOQ) of the applied technique, which consequently increases the uncertainty of an analytical result. An additional aspect which should be considered in environmental studies is the meaning of the “representative sample”. The classical and recommended approach to coping with these two “problems” is to increase the number of repetitive measurements/samplings. However, as analytical measurements at trace levels are often time consuming or expensive, and additionally increase with the number of repetitive samples, the “repetitive approach” is not often applied and thus, the reliability of the collected results rely mostly on the experience and expertise (“EE approach”) of researchers in performing sampling and analyses.

In this work the two approaches were combined. While the “EE approach” was only applied for the previously described “estuary transect/mapping” study, in the speciation study the “repetitive approach” is also respected. Variation in measured parameters along the

5. Discussion

vertical/horizontal profiles was expected to be higher than analytical uncertainties, justified additionally by the applied “EE approach”. The confidence in data quality of “EE approach”, including the representative sample and analytical measurement is “verified” by the obtained trends in trace metal distributions within all three layers, obtained for different measurement parameters, and supported largely by low analytical uncertainty. However, due to a small expected variation in concentration of some trace metals along the vertical profile at sites where “speciation study” was performed, and additionally due to the non-consistent blank levels of DGT devices, an applied “repetitive approach” consisted of collecting composite samples (6-12 subsamples), by deploying triplicate DGT devices at each depth and by repeating analytical measurements. Although some problems regarding blank levels occurred, in this way, an overall higher confidence in the obtained results was obtained.

5.4.1. Taking into consideration the level of a blank

The ultra-clean sampling and post-sampling handling is a known issue in the analysis of metals at trace level. The most common risks are associated with Zn contamination. The operational blank of strictly controlled electroanalytical determination of Zn estimated over the period of study is up to 0.5 nM. Taking into account the concentrations of Zn measured in this study, this accounted for not more than 10% of the measured concentration in sample, which is considered to be insignificant. Blank levels for other measured metals were up to ~5%. As the real blanks were unknown, in this study, concentrations of metals determined by stripping voltammetry (ASV and AdCSV) were not corrected to account for blanks, whereas those determined by DGT were corrected, as the exact blanks were measured.

As already noted in the Results section, the blank levels of Zn in DGT devices (un-deployed) were significant in comparison to concentrations found in deployed DGT. Table 5.3. lists average percentages of relative blanks (compared to accumulated metal) for open pore (OP) and restricted pore (RP) DGT devices for particular campaigns (average for all depths). These results validate previously mentioned Zn contamination problems. For the “clean” Martinska site, the blank level accounted for at least 30% (2009 07). Relatively low Zn blanks (8.3% and 14.3%) were obtained for the “polluted” marina site as a result of a much higher Zn level in the water column. Unfortunately, generally high and variable Zn blanks prevented a reliable assessment of Zn speciation and distribution along the vertical profile by using DGT technique. However, nevertheless, Zn -DGT profiles were plotted on all figures in order to keep the record of obtained Zn distributions.

For other metals, in most cases, the level of relative blanks were below 10%. Higher blanks for Pb were observed for 2010 02 and 2010 07 campaigns, and for Cu for two winter campaigns (2010 02 and 2012 03) while lower metal concentrations were found across the vertical profile. However, these increased levels of Pb and Cu DGT-blanks did not have a visible influence on the vertical distribution of DGT-labile concentrations of these metals, mainly due to the low variation in absolute blank concentrations (3 replicates), meaning that the subtracted blanks represented all other deployed DGT devices quite well. OP blanks were lower than RP blanks, however according to vertical profiles, that difference did not cause any significant deviation between OP and RP vertical profiles.

Table 5.3. Average percentage (%) of relative blank of open pore (OP) and restricted pore (RP) DGT for different campaigns, for “clean”, Martinska site (M) and “polluted” nautical marina site (S).

Campaign	Site	DGT type	average % of relative blank						
			Zn	Cd	Pb	Cu	Ni	Co	Mn
2009 07	M	OP	29.8	3.1	9.8	1.7	2.6	2.7	0.4
2009 07	M	RP	41.5	6.4	13.6	3.2	7.4	2.8	0.4
2009 07	S	OP	8.3	3.8	4.6	0.5	2.3	3.0	1.0
2009 07	S	RP	14.3	4.4	5.5	1.0	6.8	3.2	0.9
2010 02	M	OP	39.9	6.5	30.4	16.7	6.5	6.2	0.8
2010 02	M	RP	73.6	7.9	50.9	22.8	10.4	10.1	1.5
2010 07	M	OP	62.1	4.0	18.9	8.8	7.5	2.0	0.5
2010 07	M	RP	65.0	6.5	33.0	13.8	10.6	3.0	0.6
2011 07	M	OP	49.7	1.9	4.3	5.3	3.0	2.2	2.5
2012 03	M	OP	63.3	5.8	10.4	18.9	1.7	6.3	0.8
2012 03	M	RP	51.6	4.2	11.8	32.7	0.9	11.2	1.3

5.4.2. Signal intensity (feature) determination in complexometric titrations

It was shown that the treatment procedure of voltammetric curves, i.e. extraction of signal intensity (feature), could have a strong influence on the interpretation of the experimental results in voltammetry (Pižeta et al., 1999), as well as on the determination of complexation parameters (CuCC) (Omanović et al. 2010). Thus, several methods were tested in this study in order to decide which, of the most relevant methodology, would be applied for all measurements of CuCC determinations.

A test was provided on composite sample taken at 2 m depth, from summer 2009 campaign. Features used for further calculation of voltammograms registered for complexometric

5. Discussion

titration on samples of that point were peak height, peak area, the 2nd derivative of peak height, the 2nd derivative of peak area, and 1st derivative of peak height after baseline subtraction (Fig.4.32 in Results section). The results of different peak treatments for the whole series are shown in Fig. 5.11, where the Scatchard transformation shows particular differences in the first additions of Cu. The final results of the fitting of those curves, i.e. obtained complexometric parameters L_1 , L_2 , $\log K_1$, $\log K_2$ and pCu with corresponding 95% confidence intervals are depicted in Fig. 5.12. It is evident that the variability in the first data points of the complexometric titration curve is responsible for the high variability of values and confidence intervals of L_1 , the first (stronger) ligand concentration. Variability in determination of L_2 , the second ligand concentration, is considerably smaller. As there are no defined guidelines or measures as to which method is the “best”, respecting previously “EE approach” it was decided upon to adopt 1st Derivative (green squares in Fig. 5.11) as the most suitable signal feature, as a compromise regarding the uncertainties caused by the baseline and/or peak width fluctuation in signal height determination.

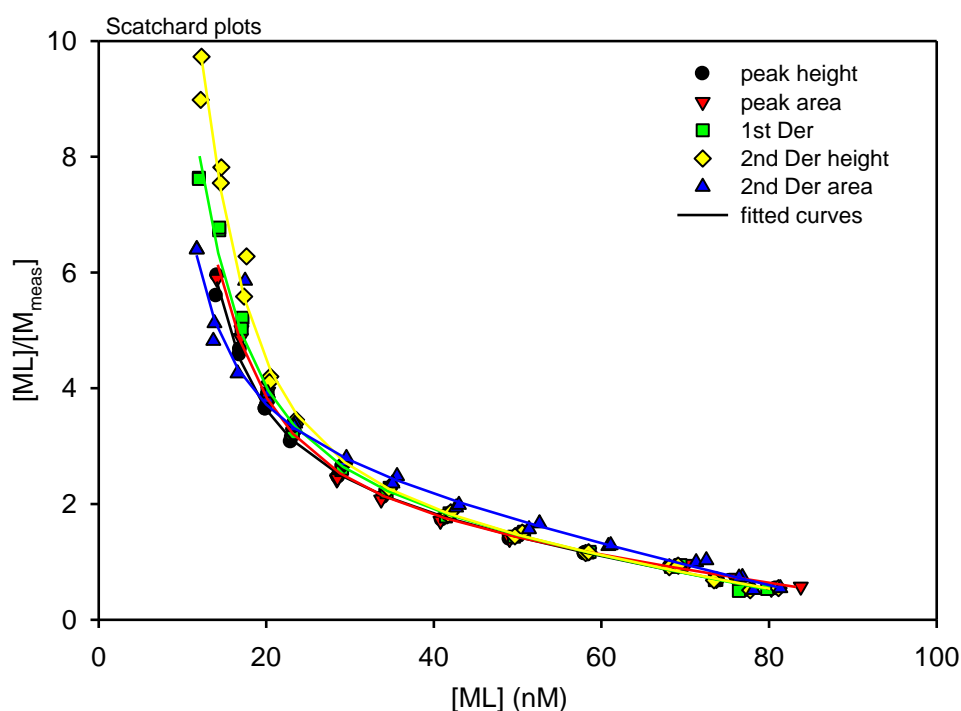

Figure 5.11. Results of different treatments of voltammograms of the series from July of 2009 at the Marine station Martinska, from a depth of 2 m – Scatchard linearization of original data points

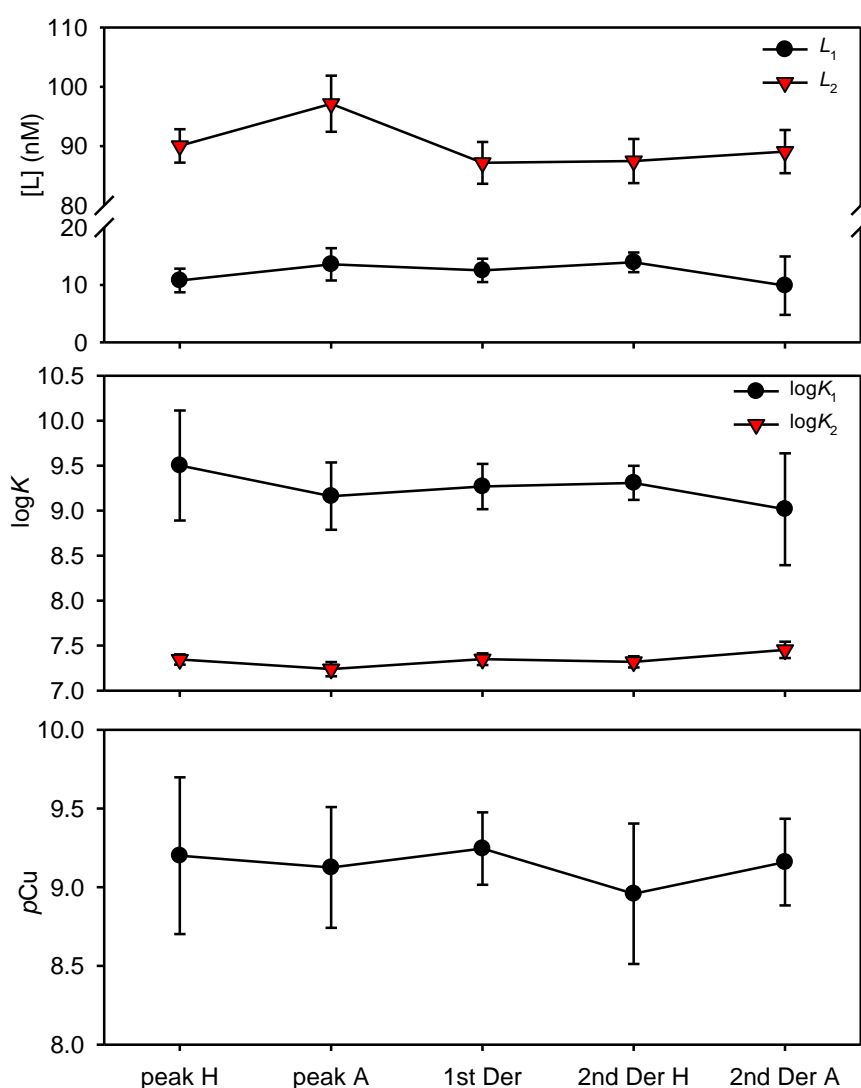

Figure 5.12. Results of fitting of complexometric titration curves derived from a different treatment of primary voltammetric signals.

5.5. Dynamic DGT speciation analysis of trace metals

Knowledge of the distribution of (toxic) trace metals in various physicochemical forms in natural aquatic systems is important for predictions of their bioavailability and environmental impact. The determination of metal speciation in such systems is a very demanding task due to the presence of natural ligands, such as humic substances (HS), with a range of different complexing properties (heterogeneity). Complexation with organic ligands was found to play an important role in “buffering” metal ion concentrations, and thus in regulating their toxicity in coastal environments (Whitby and van den Berg, 2015; Sander

5. Discussion

et al, 2015; Buck et al., 2007). This buffering property is related to their characteristic heterogeneity in chemical functionality, e.g. number and distribution of functional groups.

An additional aspect which should be considered in studies of interactions of trace metals with heterogeneous natural ligands is their kinetic properties (kinetic heterogeneity) (Town et al., 2009). Kinetic heterogeneity is accessible via non-equilibrium techniques applied in this work: anodic stripping voltammetry (ASV) and diffusive gradients in thin film (DGT), each characterised by its own kinetic window (van Leeuwen et al., 2005). Consequently, the fraction of metal complex species that is measurable by a given technique depends on the thermodynamic properties (metal-to-ligand ratio), as well as on the operational timescale of the chosen technique (kinetic properties) (van Leeuwen et al., 2005; Town et al., 2009; Plavšić et al., 1980). Thus the concentration measured by these two techniques is considered purely “operational” and termed as DGT-labile or ASV-labile.

The benefit of applying the DGT technique over ASV is that it provides an *in situ* measure of labile metal species over the period of deployment (time weighted average concentration, TWA), while ASV is restricted to analysing discrete sample, but capable of providing more information on metal-organic ligand interactions.

5.5.1. Distribution of DGT-labile metals

Fig. 5.13 presents the vertical profiles of OP DGT-labile fractions (in percentage) of all measured metals. As previously mentioned, due to the problem with high Zn blanks, inconsistent vertical profiles, and very often exceeding 100% DGT-labile fractions, were obtained. No such difficulties were found for other metals. Overall, it is obvious that the fraction of DGT-labile metals is metal-dependent and that it slightly varies depending on the salinity/depth (depending on the campaign). The DGT-labile fraction is expected to be inversely correlated with the portion of metal bound to stronger organic ligands, i.e. a lower percentage of DGT-labile is expected for metals existing in water more as stronger complexes. Based on this “principle”, the following order of binding strength/capacity, as illustrated in Fig. 3.14, was extracted: Cu>Co>Ni>Pb>Cd. This order is fully “operational” and reflects the overall chemical speciation and behaviour of these trace metals in the analysed water environments during the deployment period, and does not necessary correspond to other aquatic environments, i.e. it is considered to be “site specific”. A low Cu and high Cd average percentage of Cu labile were expected due to their known

complexation characteristics: the strong complexation of Cu with organic ligands, and the predominance of inorganic Cd to complex with chloride.

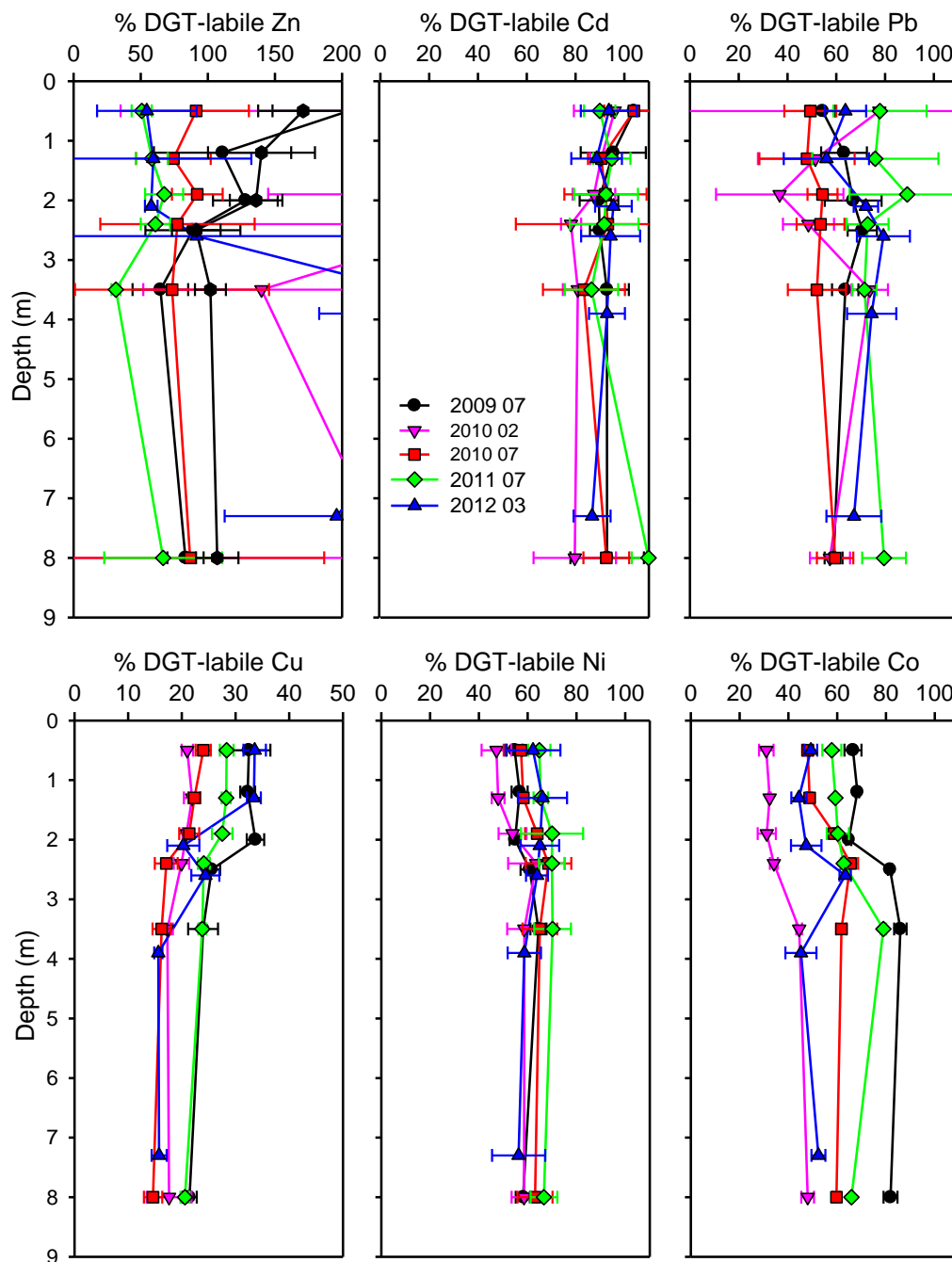

Figure 5.13. Vertical profiles of DGT-labile metal fractions (in percentage) for all campaigns. Note the different x-scale ranges.

No consistent trends in the percentage of DGT-labile metals were obtained among the three layers (Fig. 5.14). While Cd and Cu showed higher DGT-labile fractions in the brackish water layer (BW), for other metals this fraction was higher in seawater layer (SW). These

5. Discussion

trends could potentially reflect the difference in metal speciation in relation to complexation with organic ligands. However, if the percentage of DGT-labile metal fractions is plotted in relation to the dissolved metal (Fig. 5.15), it is obvious that the percentage of DGT-labile metals is dependent on the dissolved metal concentration.

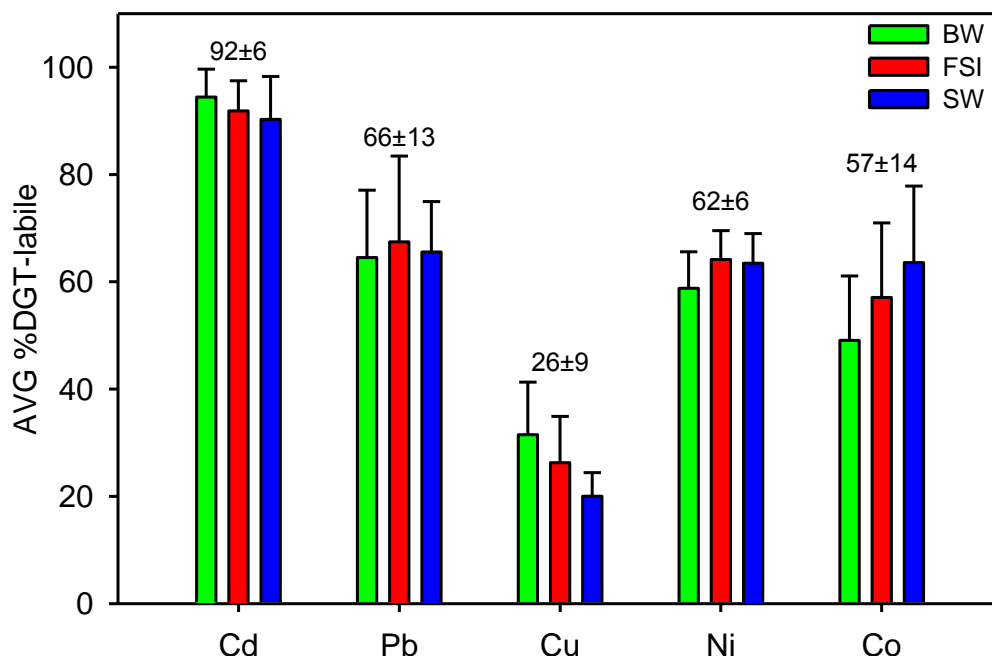

Figure 5.14. Average percentage of DGT-labile metals for each separate layer along the salinity gradient (data averaged from all campaigns). Number above bars represents the overall average percentage (all depths). Uncertainty is expressed as a standard deviation.

The DGT-labile fraction of Cd decreases with an increase in dissolved concentration. Taking into account that the dissolved Cd concentration is higher in the seawater layer (SW) than in the brackish (BW) layer, that the DOC level is lower in SW than in BW, and that the complexation of Cd with chloride is favoured in SW, this trend suggests that the complexation of Cd with organic ligands is more pronounced in SW than in BW. Although observed at low absolute difference, the applied DGT technique was able to provide an insight into partial Cd speciation along the vertical salinity gradient in the Krka River estuary.

Contrary to Cd, an increasing trend of DGT-labile Cu fraction with a dissolved concentration was observed. Higher concentrations of Cu and DOC were generally found in BW than in SW. However, the concentration and complexation properties toward Cu of existing natural ligands were not sufficient to “buffer” increased Cu concentration, i.e. to maintain DGT-

labile Cu fraction at the level independent of Cu dissolved concentration. If the winter 2010 campaign, characterised by a higher dissolved Cu concentration in SW than in BW, and by a uniform distribution of DOC along with the salinity gradient, is examined separately (red triangles in Fig. 5.15), the decreasing trend with an increasing concentration was observed as in the case of Cd, also suggesting a stronger complexation of Cu in SW than in BW.

Applying a similar approach, examination data from Fig. 5.14 and Fig. 5.15 suggests that the complexation of Co is stronger in BW than in SW layer, while from the data for Pb and Ni, no clear conclusions could be drawn.

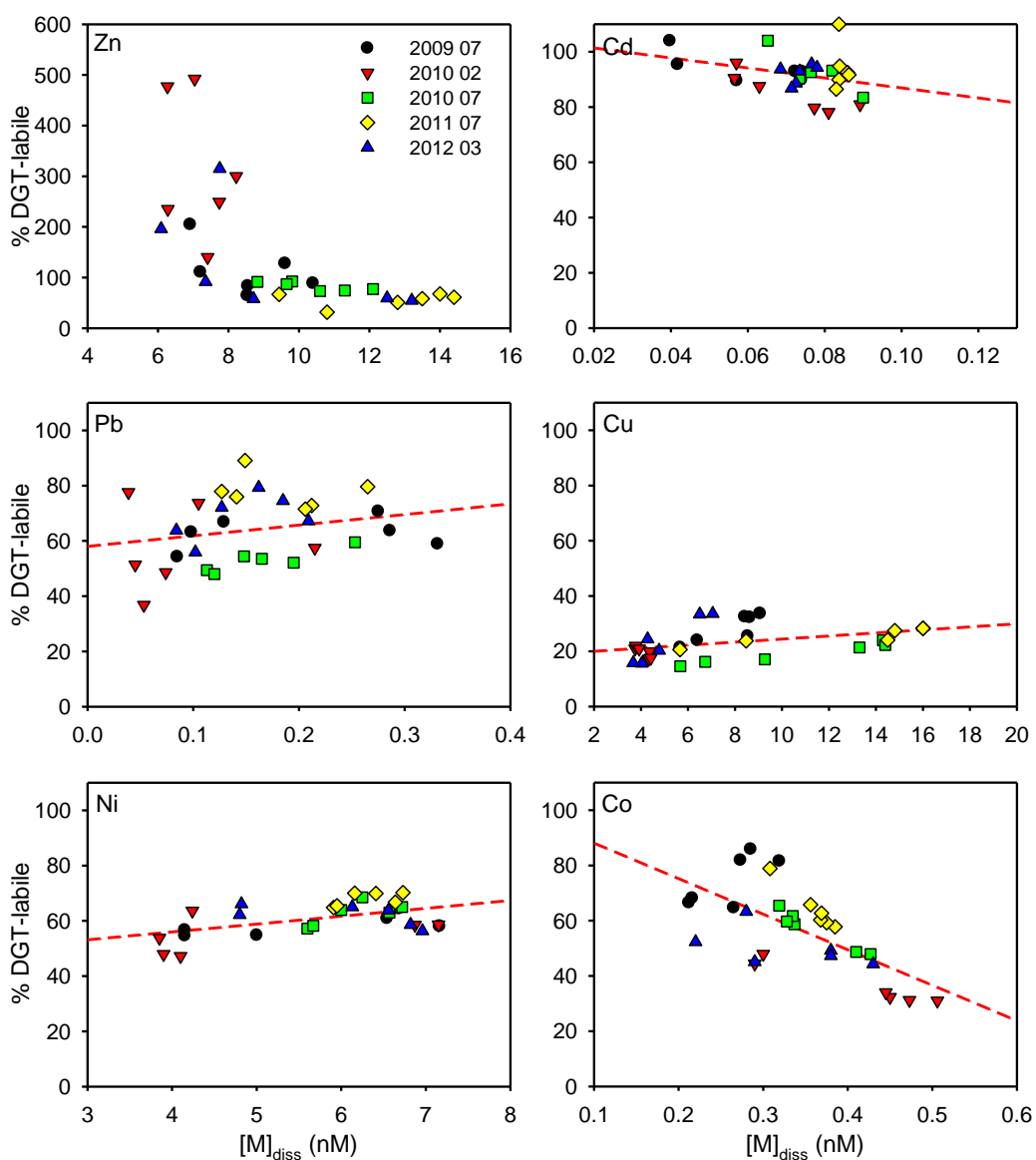

Figure 5.15. Dependence of percentage of open pore (OP) DGT-labile metals on dissolved metal concentrations (“clean” site). Red dotted regression line indicate the observed trend.

Fig. 5.16 presents an overall percentage of open pore (OP) and restricted pore (RP) DGT-labile metals for all depths and all campaigns. As noted previously, the difference between DGT-labile concentrations determined by OP and RP probes is negligible, i.e. within the experimental error. This prevented of getting more insight into the distribution of metal-organic ligand having different complexation properties. In other words, the differences among the heterogeneous metal-organic ligand complexes existing at ambient conditions are indistinguishable by the two different applied DGT types.

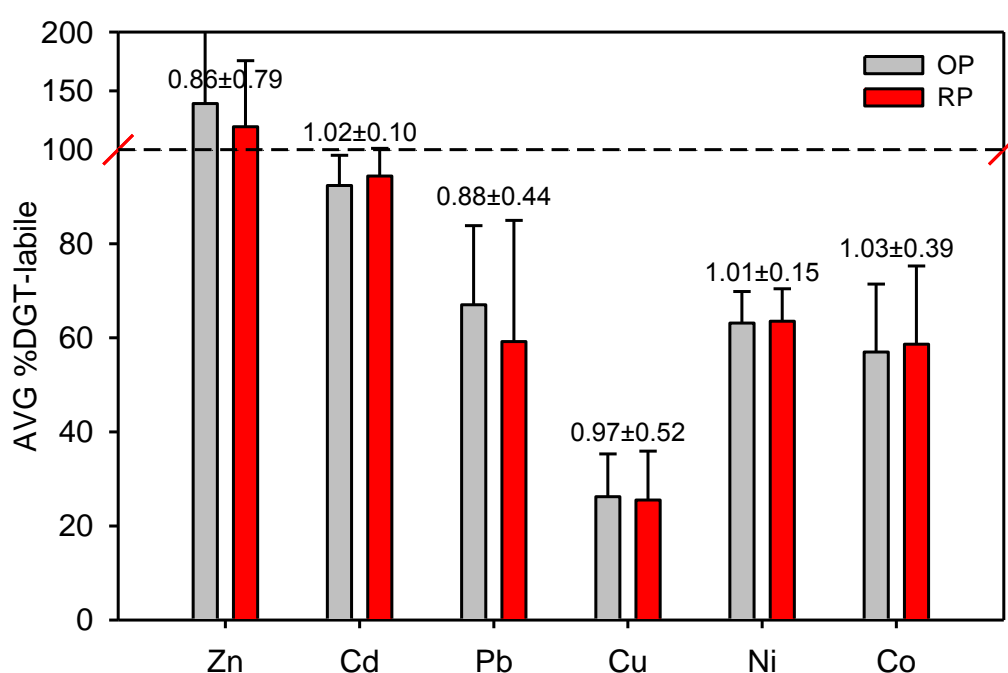

Figure 5.16. An overall average percentage of open pore (OP) and restricted pore (RP) DGT-labile metals (all depths, all campaigns). Numbers above bars indicate ratio between OP and RP DGT-labile concentrations. Uncertainty is expressed as standard deviation.

A characteristic feature of heterogeneous ligands (e.g. humic substances, HS) is that their affinity for metals is a function of the metal-to-ligand ratio (Town et al., 2009). Binding of metals by HS, which is common in estuary and coastal waters (Whitby and van den Berg, 2015; Sander et al., 2015; Buck et al., 2007), could be described by a distribution characterised by the average conditional stability constant (K), as a function of the degree of the binding site occupation. In order to apprehend the variations in binding sites affinities toward metals, a heterogeneity parameter Γ , is introduced. The value of Γ could be obtained

from the slope of a plot of metal binding affinity versus the degree of site occupation, i.e. by plotting DGT-labile concentrations versus dissolved metal concentrations normalized by DOC (Fig. 5.17).

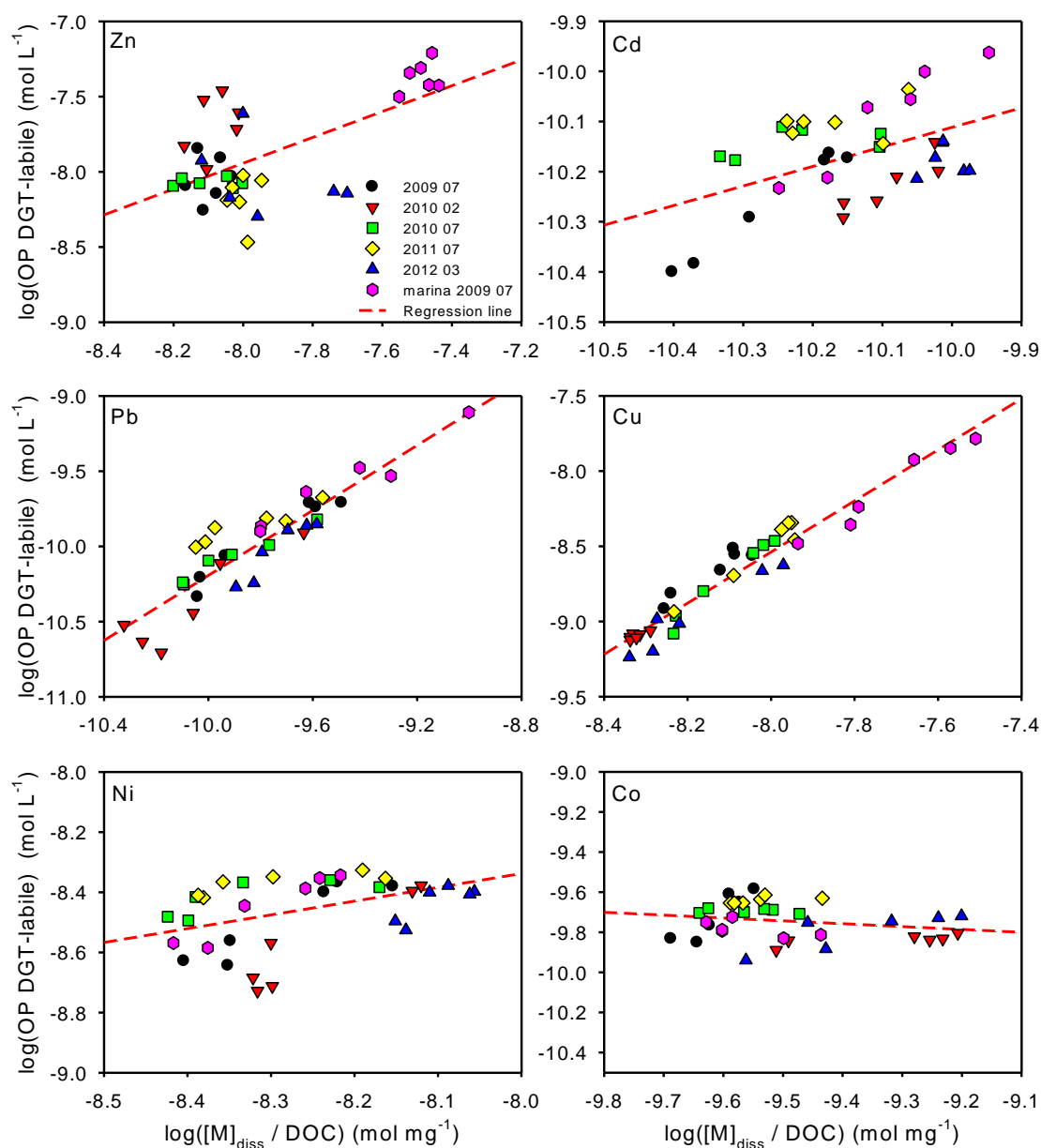

Figure 5.17. DGT-labile Cu concentrations in relation to the dissolved metal concentration normalized by DOC (metal-to-ligand ratio).

The published values of Γ for metal binding by HS are 0.3–0.5 for Cu, 0.6–0.8 for Pb, 0.8–1.0 for Cd, and 0.6 for Ni (Town et al, 2009 and references within the manuscript). Low Γ values represent more heterogeneous sites, while $\Gamma = 1$ assumes a fully homogeneous binding site distribution. Fig. 5.17 presents such a plot from which heterogeneity factors were estimated for Cd (1.0*), Cu (0.59) and Pb (0.92). Due to unreliable results of DGT-

labile Zn, the value was not calculated, while the obtained values for Ni and Co do not make sense due to the too-narrow range of measured concentrations. The same problem of the too-narrow examined range of concentrations was also true for Cd, and the provided value (1.0*) was obtained by excluding two winter campaigns. The calculated heterogeneity factor reflects not only the distribution of stability constants but also the dissociation rate constants of existing metal complexes, which came into significance due to the relatively large diffusion layer thickness and consequently longer characteristic “kinetic timescale window”.

5.5.2. Correlation between DGT-labile and predicted dynamic metal concentrations

Considering the environmental relevance of metals, their spatio-temporal distributions are typically examined in relation to their bioavailability and/or toxicity. According to the most recent EU directive regarding priority substances in the field of water policy (Directive 2013/39/EU, 2013), bioavailability is listed as a water quality issue for metals. According to this directive, when assessing the monitoring results against the relevant environmental quality standards (EQS), the hardness, pH, dissolved organic carbon or other water quality parameters that affect the bioavailability of metals, the bioavailable concentrations being determined using appropriate bioavailability modelling, may be taken into account. Looking from an experimental aspect, the DGT as a dynamic metal speciation technique is widely applied for monitoring purposes, providing (potentially) bioavailable concentrations of metals analogue to those derived by mathematical modelling. DGT-labile concentrations are very often compared to those provided by some of modelling tools (Meylan et al., 2004; Unswort et al., 2006; Warnken et al., 2008; Han et al., 2014, Omanović et al., 2015). While in most of the cases a very good correlation between measured and predicted labile concentrations was found (matching of trends), agreement in absolute values was very variable. In our study, a comparison approach used in work of Han et al. (2014) was respected. For the calculation of dynamical concentration of metals (predicted), which is compared finally to measured DGT-labile concentrations, the following equation was used:

$$C_{pred} = C_{free} + C_{inor} + \frac{C_{FA}D_{FA}}{D_{inor}} + \frac{C_{HA}D_{HA}}{D_{inor}}$$

C_{FA} , C_{HA} and D_{FA} , D_{HA} are concentrations of metal complexes with fulvic (FA) and humic (HA) acids, and corresponding diffusion coefficients, respectively. It should be highlighted that for this purpose diffusion coefficients for metal complexes with FA and HA are assumed to be the same as for FA and HA itself. These diffusion coefficients are taken from the paper

of Zhang (2004). For modelling of chemical speciation, a free program Visual MINTEQ ver. 3.0 was used. The same major anion and cation concentrations as for calculation of Cu inorganic “side reaction coefficient” were used. For each sample, a corresponding DOC concentration and dissolved metal concentrations were used. Modelling of interactions of metals with organic ligands was performed by Stockholm Humic Model (SHM). It was considered that 90% of organic matter is represented by FA, and 10% by HA. No other adaptation of default parameters was undertaken.

Fig. 5.18 presents obtained results for all metals, while in Table 5.4 obtained correlation coefficients and the slopes of the linear regression between measured and predicted DGT-labile concentrations were provided. No consistent performance was obtained among metals. In case of Zn, the disagreement is mainly related to problem of contamination already discussed previously. For Cd quite well relative (correlation) and absolute (slope around 1) agreement between two concentrations was obtained. This agreement is mainly related to relatively weak complexation of Cd with organic matter, i.e. existence of Cd primarily in inorganic complexes with chloride.

Table 5.4. Pearson's Correlation coefficients and the slopes of the linear regression (in parentheses) between measured and predicted DGT-labile concentrations.

	Zn	Cd	Pb	Cu	Ni	Co
all samples	0.76 (0.51)	0.94 (1.03)	0.99 (0.68)	0.95 (0.35)	0.93 (1.19)	0.12 (0.22)
w/o „polluted“	-0.52 (-0.16)	0.90 (1.07)	0.96 (0.55)	0.94 (0.56)	0.94 (1.20)	0.11 (0.21)

While a high correlation factors for Pb and Cu were obtained, the predicted dynamic (labile) concentrations were lower than the DGT-measured (slope $\ll 1$). If only inorganic fraction of Pb and Cu is considered as dynamic one, the results are even worse (crosses in figures; due to the similarities in values, data for “only inorganic M” are not plotted for other metals). Based on such modelling approach, it is unquestionable that the part of organic complexes is accumulated by DGT. However, the major question is about the “source“ of disagreement between DGT-measured and predicted concentrations. As a first, there is no evidence that DOC can be represented only by 90% as FA and 10% as HA, i.e. all other partitioning could also be possible, especially in an estuarine zone, where other types of organic matter issued from estuarine aquatic organisms is present, which most probably differ in complexation characteristics from classical terrestrial humic substances. In our calculations it was assumed that all metal complexes with FA and HA are labile and accessible to DGT. The only

5. Discussion

difference compared to inorganic complexes is the applied diffusion coefficient (in our work values taken from Zhang (2004) are $1.15 \times 10^{-6} \text{ cm}^2 \text{ s}^{-1}$ for FA and $0.6 \times 10^{-6} \text{ cm}^2 \text{ s}^{-1}$ for HA metal complexes). However, recently Balch and Guéguen (2015) showed that diffusion coefficients for “bulk” dissolved organic matter and HS are 2-3 times higher than values we used for calculations. If the operational diffusion coefficients of organic metal complexes are increased by factor of 3, an overestimation of dynamic metal fractions of Cu and Pb occurred.

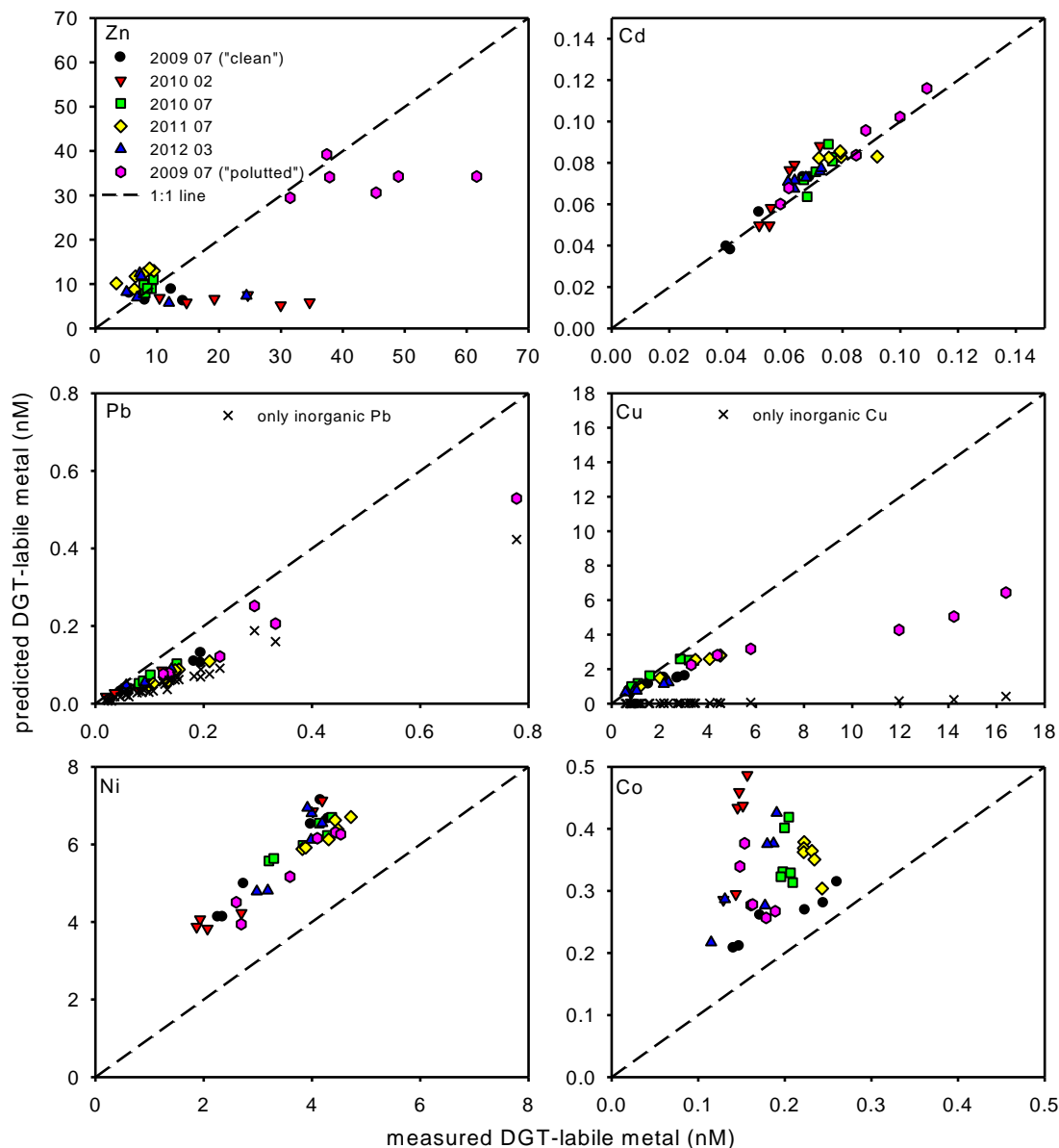

Figure 5.18. Comparison between measured DGT-labile and predicted dynamic metal concentrations.

Technically, operational diffusion coefficients could be obtained by minimizing the absolute difference between predicted and measured concentrations using Solver option in Excel,

however such “adaptive” approach is purely speculative. In addition to decreased diffusion coefficients, there exist strong/inert metal complexes which are not accessible to DGT. Predicted dynamic metal concentrations for Ni and Co are higher than DGT-measured, with the difference that a high correlation was found only for Ni. A better agreements between measured DGT-labile and predicted dynamic metal concentrations were found in studies performed in rivers (Meylan e al., 2004; Unswort et al, 2006; Warnken et al., 2008; Han et al., 2014, Omanović et al., 2015). This is even expected because the modelling of metal-organic ligand interactions incorporated in programs are basically developed on the basis of data collected primarily in studies performed in freshwater environments.

Thus, the prediction of metal speciation in estuarine or seawater system is still a challenging task, demanding the extensive and more focused studies.

5.6. Voltammetric speciation of Cu – determination of CuCC

Copper-binding organic ligands make up a subset of natural dissolved organic matter (DNOM), which tend to dominate the chemical speciation of dissolved Cu in a range of marine environments (Coale and Bruland, 1988; Sedlak et al., 1997; Bruland et al., 2000; Buck and Bruland, 2005). In coastal environments, potential sources of these ligands range from natural humic and fulvic material to urban discharge carrying anthropogenic ligands like EDTA and NTA. In addition, microorganisms sensitive to copper toxicity are known to be able to produce copper-binding ligands in a solution themselves, further lowering the potential toxic conditions of their surrounding environment (Sunda and Huntsman, 1995; Moffett and Brand, 1996; Gordon et al., 2000). Although recent studies have investigated the conditional stability constants and the distribution of copper binding organic ligands (Wiramanaden et al, 2008), information about their chemical structure or important functional groups involved in copper binding is lacking. Instead, these ligands are often described using a discrete model, assuming, in most cases, a redistribution to stronger (L_1) and weaker (L_2) ligand classes, representing the averaged affinities of all individual Cu ligands with similar complexing characteristics. These affinities are expressed in terms of conditional stability constants, K , which describe the distribution of Cu between the CuL complexes and the Cu ions (expressed either via free hydrated ions or the sum of inorganic species).

Metal complexation studies are performed in order to determine metal speciation at the ambient metal concentration, and to determine metal complexation parameters, which could

5. Discussion

be used to predict the metal speciation at any metal concentration. The main purpose of these studies is to estimate the bioavailable metal concentration and to evaluate their toxicity. The described speciation “approach” is respected in our work. Results of ligand concentrations and conditional stability constants presented in Table 4.10 are plotted in Fig. 5.19.

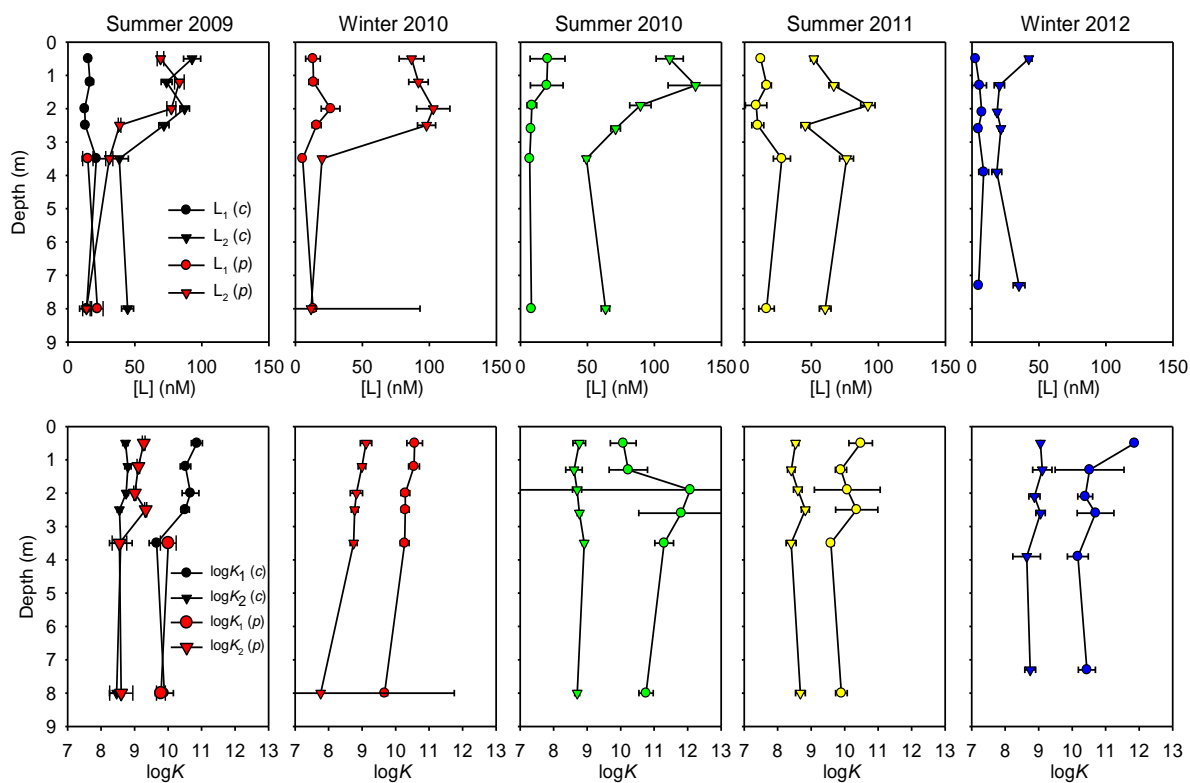

Figure 5.19. Vertical profiles of the concentration and conditional stability constant for stronger ($[L_1]$, $\log K_1$) and weaker ($[L_2]$, $\log K_2$) ligands for all experiments. In the first column, plot “c” and “p” denote the “clean” and “polluted” site. Uncertainty (error bars) is expressed as a 95% confidence interval (CI).

With the exception of the four uppermost points at the “polluted” nautical marine site (2009 07 campaign), for all other samples, two types of ligand classes, stronger L_1 and weaker L_2 , were determined. Concentrations of the stronger L_1 ligand, ranged from 2.7 nM in winter, up to 28 nM in summer, whereas concentrations of the weaker L_2 ligand ranged between 12 and 131 nM (see Table 5.4). These values are within the previously published ranges for various estuary sites (Plavšić et al, 2009), as well as for the location in this study (Louis et al., 2009). The stronger ligand class not determined in the work of Plavšić et al. (2009) could be due to the shorter accumulation time applied (60 s, compared to 300 s in the other two studies), which was found to be insufficient to determine labile Cu at low additions (Omanović et al., 2010).

Overall, higher total ligand concentrations ($L_1 + L_2$) found in the surface layer, compared to in the seawater layer, are also consistent with two previous studies (Table 5.5). However, while results obtained in the study of Louis et al. (2009) indicated an increasing strength (conditional stability constants) with an increase in salinity/depth, our results showed a slight, but opposite trend, which could be perceived visually in Fig. 5.19. Although the averaged values of the conditional stability constants for each layer show similar behaviour (Table 5.6), due to the high variability among the sampling campaigns, expressed as a standard deviation (uncertainties (\pm) in Table 5.6), these averaged values could not be used statistically to confirm the observed trends.

Table 5.5. Comparison of Cu complexation parameters in this and previous studies in the Krka River estuary.

	Cu _T (nM)	L_1 (nM)	L_2 (nM)	log K_1	log K_2
Plavšić et al, 2009.	1.4-29.0	ND	57-179	ND	8.7-9.4
Louis et al, 2009.	4.7-8.9	6.0-7.1	68-139	11.2-13	8.8-10
this study	3.7-16.0	2.7-28	12-131	9.6-11.9	8.4-9.1

Table 5.6. Average complexation parameters for stronger (L_1) and weaker (L_2) ligands for the surface brackish layer (BW), freshwater-seawater interface layer (FSI) and seawater layer (SW).

	BW	FSI	SW
[L_1] (nM)	13.5 \pm 5.6	11.7 \pm 6.0	12.7 \pm 7.5
[L_2] (nM)	76.9 \pm 33.0	69.8 \pm 30.9	41.7 \pm 21.2
log K_1	10.55 \pm 0.53	10.68 \pm 0.60	10.17 \pm 0.55
log K_2	8.81 \pm 0.25	8.77 \pm 0.14	8.56 \pm 0.32

A slightly higher conditional stability constant at a lower salinity could be ascribed to the smaller competition effect of major divalent cations for which the concentration is lower in the brackish layer. Such trends were described in laboratory conditions by Hamilton-Taylor et al. (2002), studying copper speciation in estuarine conditions with humic acid.

Existence of two ligand classes and a relatively large range of obtained conditional stability constants is also in accordance with the heterogeneity of Cu complexes obtained by analysing DGT-labile results. On average, the concentrations of both ligand classes is higher in summer than in winter (Fig. 5.20). Essentially, an increase in ligand concentration is in accordance with the increasing DOC concentration, and could be explained by an increase in primary production during the summer period. Excluding the two uppermost points from

5. Discussion

the L_1 -plot, statistically significant correlation coefficients between ligand and DOC concentrations were obtained. In addition, the range of measured L_1 concentrations increases with DOC, which potentially signifies an increased range of binding sites at a higher DOC concentration. However, a more detailed study should be performed in order to confirm such trends.

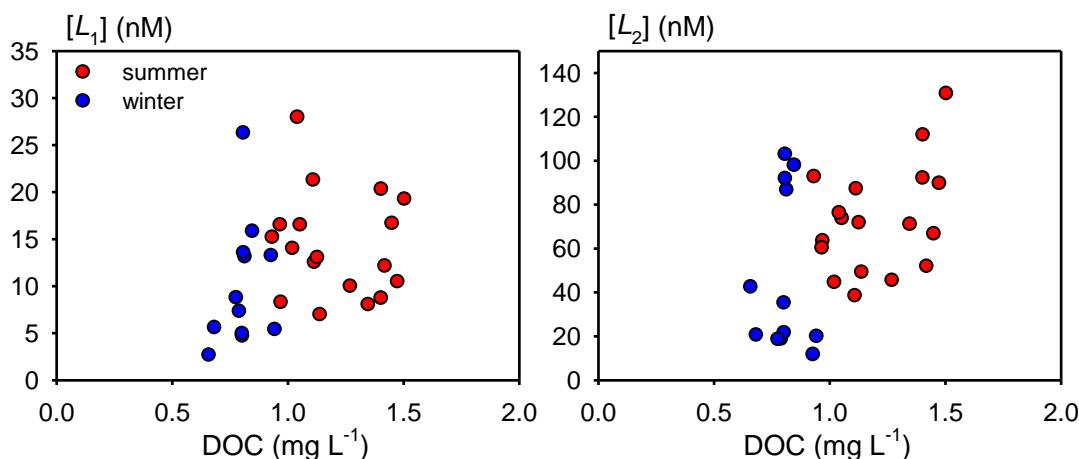

Figure 5.20. Dependence of the concentration of stronger ($[L_1]$) and weaker ($[L_2]$) ligands on the concentration of dissolved organic carbon (DOC).

As mentioned previously, the purpose of complexation studies is to determine the chemical speciation of metals, and to estimate the free metal concentration, the form which is considered to be the most bioavailable, and in the case of Cu, the most toxic. Using estimated complexation parameters for both ligand classes, the concentration of free Cu was calculated and plotted in relation to the depth for each sampling campaign (Fig. 5.21). The dashed vertical line at a concentration of 10 pM corresponds to the toxicity threshold of Cu as estimated for marine phytoplankton by Sunda et al. (1987). Except four points corresponding to the winter 2010 campaign (uppermost depths), the threshold value is surpassed, suggesting that at these ambient conditions, Cu should be considered potentially toxic. There is an accepted opinion that in coastal waters, Cu is bound to strong complexing ligands, diminishing its free concentration to below the toxicity level of 10 pM (Buck et al, 2007). It is reported that more than 99% of dissolved Cu at its ambient concentration exist in these strong complexes. These data are derived primarily through competitive ligand exchange adsorptive cathodic stripping voltammetry (CLE-AdCSV), which is known to provide higher stability constants than the ASV method. In our study, a much higher degree of labile Cu is measured, ranging from 5 to almost 30% (70% to 95% of organically-bound Cu). The difference between the two methodologies is that ASV reduces (accumulate) weak organic

Cu complexes along with the inorganic Cu. However, the conditional stability constant of Cu complexes in the case of ASV is expressed via free Cu ions, which are obtained using the side reaction coefficient calculated by only considering inorganic complexes, and not weak organic complexes which are reduced along with the inorganic Cu species. This means that the conditional stability constants of Cu obtained by ASV are underestimated because they do not account for the side reaction coefficient of weak organic complexes. The exact side reaction coefficient of these complexes is unknown, but if assumed to be just 10 times higher, the free Cu concentration would be estimated to be lower by an order of magnitude, and consequently the organic Cu fraction would increase.

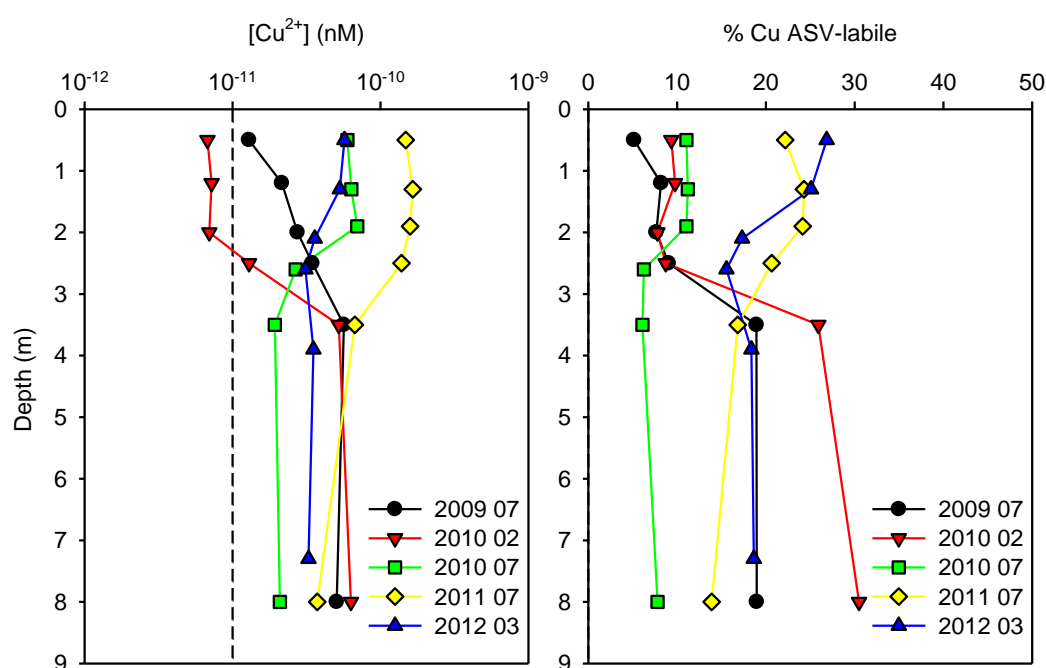

Figure 5.21. Vertical distribution of calculated free Cu concentration ($[Cu^{2+}]$) (left plot) and percentage of ASV-labile copper (right plot) for all sampling campaigns.

However, it seems that free or organically bound Cu is strongly dependent on the applied methodology, whether CLE-ADCSV or CLE-ASV. Namely, by using EDTA as a competitive ligand in ASV mode, in freshwater samples Wang and Chakrabarti (2008) found the presence of a very strong copper-binding ligand with a $\log K \sim 20$, and a corresponding very high concentration (above 100 nM) of the ligand. This is the highest stability constant ever reported for Cu in natural waters. Applying the same method of calculation, the estimated free ligand concentration would be several orders of magnitude lower than the one calculated by CLE-AdCSV. These results put to question the methodology of the calculation

5. Discussion

of organically bound Cu, and the estimation of its free concentration, and should be further checked for consistency and correctness.

It was mentioned previously that DGT-labile metal concentrations are an operational value, dependent on several parameters. The same applies for ASV-labile concentrations, which, at the ambient Cu level correspond to sum of inorganic and weakly bound organic fraction. Both techniques are considered dynamic techniques, which means that the measured concentration depends not only on the thermodynamic properties of existing metal complexes but also on kinetic properties (van Leeuwen et al., 2007). The kinetic properties are viewed in relation to the so-called kinetic timescale of the technique i.e. kinetic windows, i.e. the effective time available for complex species to dissociate within the diffusion layer. Both the DGT and ASV technique accumulate metals in the same manner, which is also assumed to represent a basic model of the uptake of metals across the biological membrane. Thus it is expected that DGT and ASV could provide similar information regarding the distribution of labile metal species in a particular water environment. A comparison between inorganic Cu estimated by ASV and OP DGT-labile Cu is plotted in Fig. 5.22., while separate vertical profiles were presented in Fig. 5.23. A general liner relationship was found between the two operationally labile concentrations with a correlation coefficient of 0.964.

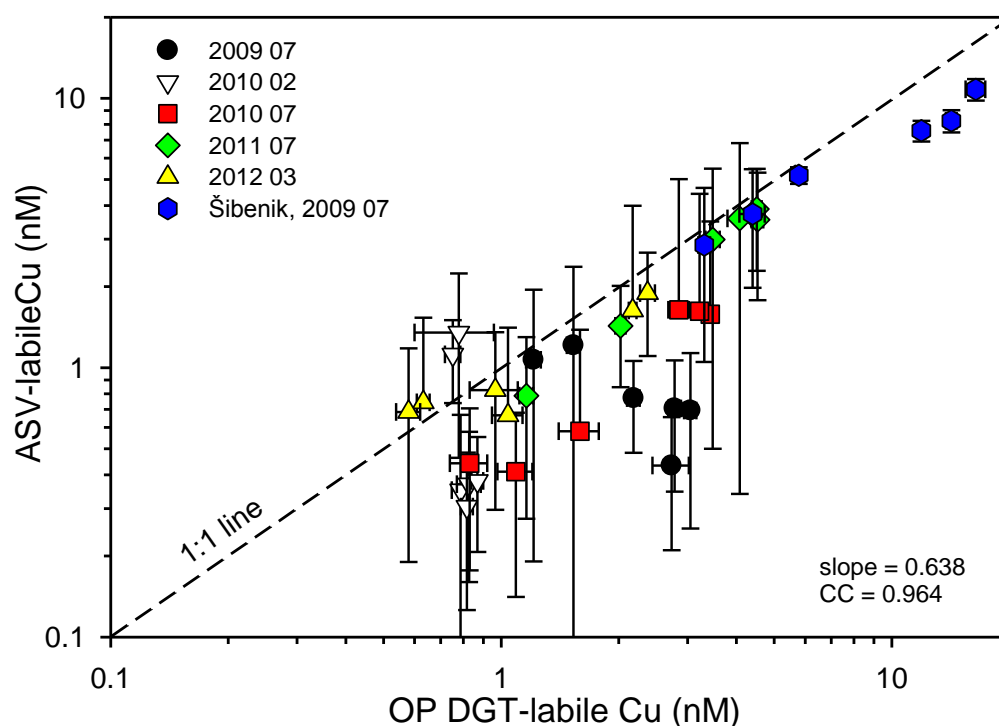

Figure 5.22. Relationship between labile Cu estimated by ASV (assumed to represent inorganic fraction) and OP DGT-labile Cu for all campaigns.

Most of the values are located under the 1:1 line, which means that the determined ASV-labile concentrations were lower compared to those of DGT, and in average they accounted for around 64% of those of DGT-labile. A relatively good agreement between the two profiles is even more evident in Fig. 5.23. Only the profiles for the first campaign and, slightly for the second, showed an opposite trend, which could be ascribed to specific ambient conditions at the site regarding Cu and DOC levels. A much better agreement between vertical profiles for that campaign (2009 07) obtained from the “polluted” nautical marine site presented in Fig. 5.24 is mainly the consequence of higher Cu concentrations.

The smaller labile fraction estimated by ASV was expected because of the shorter kinetic window. The effective time of the measurement for the ASV is 0.1 s, with a diffusion layer thickness of 10 μm , and a diffusion coefficient of $5 \times 10^{-6} \text{ cm}^2 \text{ s}^{-1}$, whereas in the DGT device the diffusion layer thickness is 0.9 mm and the effective measurement time is 13.5 minutes (Zhang and Davison, 2000). The importance of the diffusion layer thickness regarding the operational determination of lability of metal complexes and their kinetic contribution to the ASV signal, is already discussed in many papers (Plavšić et al., 1980; Lovrić et al., 1984; van Leeuwen et al., 2007, Town et al., 2009).

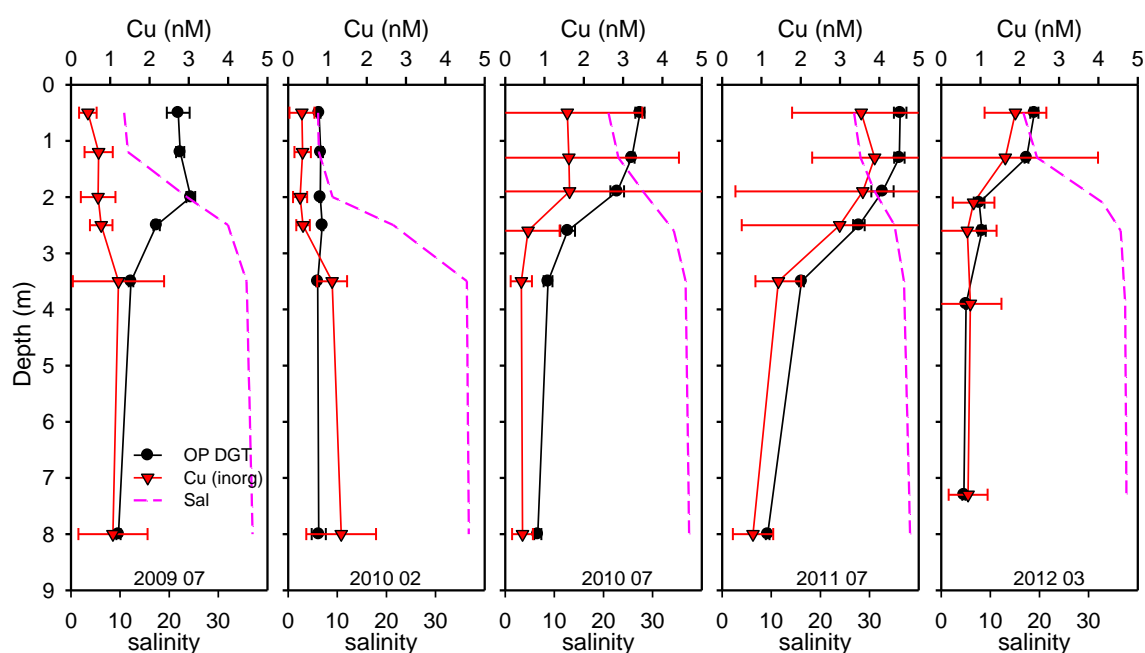

Figure 5.23. Relationship between labile Cu estimated by ASV (assumed to represent the inorganic fraction) and OP DGT-labile Cu for all campaigns.

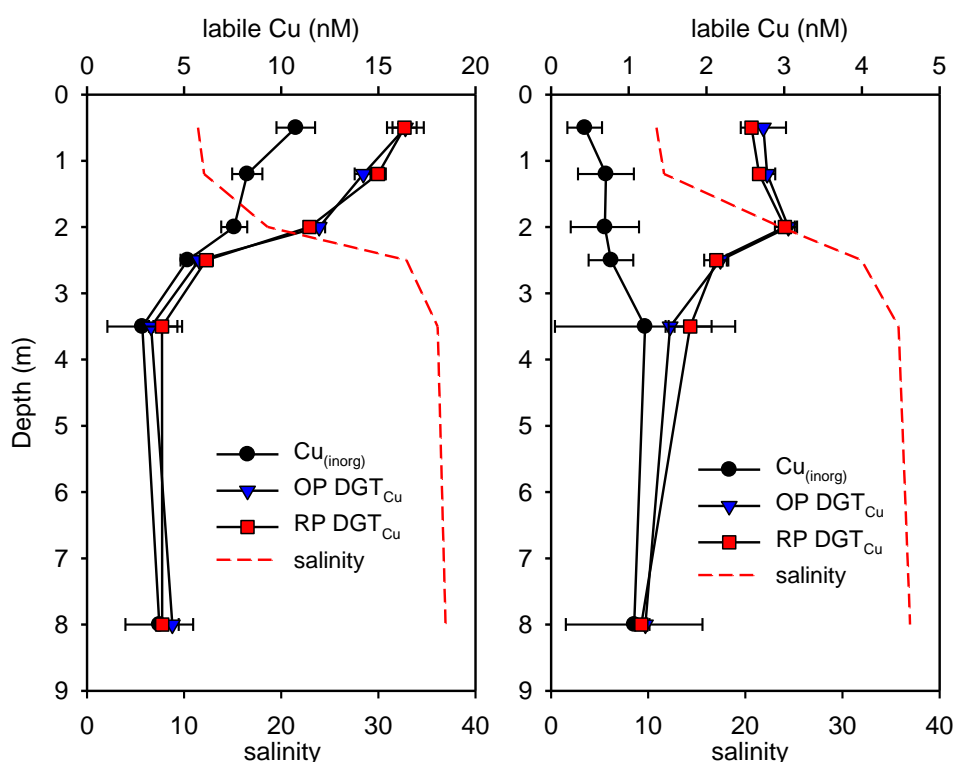

Figure 5.24. Relationship between labile Cu estimated by ASV (assumed to represent the inorganic fraction) and OP and RP DGT-labile Cu “polluted” site (left plot) and “clean” site (right plot).

5.7. Environmental aspects – potential toxicity effects

Due to the known role of Cu in natural waters related to bioavailability/toxicity to aquatic organisms (Fichet et al., 1998; Santore et al., 2001; Ytreberg et al., 2011), monitoring of its dissolved concentration in such highly variable systems is of great importance. However, knowledge of Cu chemical speciation is of much greater benefit, especially because an increase in dissolved Cu, in combination with low levels of DOC in the Krka River estuary, may induce an increased bioavailable (free ion) fraction, surpassing the toxicity level (10 pM) for some marine organisms (Sunda et al., 1987), as shown recently by Louis et al. (2009) (Louis et al., 2009a). Ecotoxicologically-based, marine acute water quality criteria for metals intended for the protection of coastal areas recently proposed by Duran and Beiras (2013) (Duran and Beiras, 2013) quote 22 nM of dissolved Cu as the upper limit. This is equal to the highest concentrations we measured along the estuary transect (excluding highly elevated sites within the Šibenik bay obtained during the mapping survey), warning on caution if the intensity of nautical traffic further increases. However, taking into account that dissolved Cu concentrations within the Šibenik bay increased up to 68 nM and that the DOC concentration

remained at a level of $\sim 1.5 \text{ mg L}^{-1}$, potentially harmful effects are likely to occur for some sensitive plankton species, which are commonly adapted to “pristine” environmental conditions, as shown by Jean et al. (2012), who found that the zooplankton diversity/abundance variation is linked to the pollution gradient.

Buck et al. (2007) found that dissolved copper concentrations throughout the San Francisco Bay also correlate positively with dissolved organic matter, supporting results from speciation studies which indicated that organic ligands with high-affinity for binding Cu dominate the chemical speciation of dissolved Cu. These organic ligands typically bind $>99.9\%$ of the dissolved Cu, effectively buffering the system against small changes in dissolved copper concentrations, and maintaining free Cu^{2+} concentrations well below the toxicity threshold of ambient aquatic microorganisms.

In an inorganic system without organic ligands, $[\text{Cu}^{2+}]$ can be calculated directly from the total dissolved copper concentrations (Cu_T). For instance, at average pH values in seawater (pH 8.1), the inorganic speciation of copper favours CuCO_3 as the dominant species, with 7% of the total dissolved inorganic copper appearing as a free hydrated Cu^{2+} ion. At 30 nM of dissolved Cu, which is the concentration found in Šibenik bay, the concentration of Cu^{2+} in the absence of organic chelation would be approximately between 1 and 2 nM depending on the salinity. At these Cu^{2+} levels the majority of aquatic microorganisms in this environment would likely suffer from the effects of copper toxicity.

The correlation between DOC and dissolved Cu observed in Šibenik bay especially in summer periods, despite a high level of dissolved Cu and the absence of any evidence of Cu toxicity, suggests that organic complexation is lowering Cu^{2+} levels to sub-toxic levels, although ASV measurements projected higher free Cu levels.

6. Conclusions

6. Conclusions

The Krka River estuary is an atypical estuary characterized by a very low input of trace metals (TM), suspended particulate matter (SPM) and organic carbon (OC) by the river. From the other side, the adjacent coastal sea features the environment of an open sea. These particular characteristics, coupled by the three vertically stratified layers, allowed identification of pathways and processes governing horizontal and vertical redistribution of TM across the whole estuary, whether they are added in the system by human activity or by “in-situ” processes (e.g. remobilisation from the sediment). In addition, the “calm” nature and the “sensitivity” of the estuarine system allowed recognition of particular phenomena and events which influence the biogeochemistry of TM within the estuary.

The obtained results could be summarized by a few final remarks:

- the significant anthropogenic inputs of some TM especially observed in summer can be mainly ascribed to nautical activities, as evidenced by the high resolution surface mapping,
- the non-conservative organic carbon behaviour, mostly linked to biogenic production in summer which increase both, DOC concentration and POC concentration/content, significantly affects TM behaviour and fate,
- the dissolved/particulate fractionation of TM appears to be mostly controlled by the variation of SPM nature along the salinity gradient (winter, surface) and the biogenic production of SPM (summer, surface),
- the significant increase of most of the TM in the seawater layer is result of TM scavenging through the FSI coupled with upstream seawater transport and long residence time, leading also in increase of particulate TM fraction (e.g. Pb),
- the specific TM behaviour identified in the cuvette, a consequence of anoxia conditions induced by long water accumulation and settling of organic-rich particles, is a situation not only limited to this restricted area but can occur at a larger scale in the estuary, and more generally, in many environments submitted to both, strong stratification and significant organic carbon load,
- the significant anthropogenic TM inputs (e.g. Cu leaching from antifouling paints) in such a naturally pristine environment may induce harmful effects on sensitive species such as phytoplankton not “adapted” to such conditions,

6. Conclusions

- the studies in such a unique environment allow identification of processes which are generally overrode by a large load of SPM (and associated elements) from the river and homogeneous vertical profiles,
- very good agreement between the vertical profiles of DGT-labile, and dissolved TM concentrations suggests that the DGT technique can be successfully used to determine potentially bioavailable TM concentrations in estuarine conditions,
- the fraction of DGT-labile TM, which reflects their chemical speciation (primarily, their binding to natural organic ligands), ranged from > 90% for Cd, to < 20% for Cu, but also depends on the concentration ratios of metals and organic ligands,
- voltammetric speciation of Cu showed the presence of two types of organic ligands that form strong (L_1 , $9.6 < \log K_1 < 11.9$) and weak (L_2 , $7.8 < \log K_2 < 9.9$) Cu complexes. The concentration of weak organic ligands (L_2) is correlated with the DOC concentration, and is higher in summer, most probably due to the increased biological activity,
- the range of measured total organic ligands concentrations (complexing capacity) is similar as ~30 years ago, confirming the status of the estuary in regards to overall organic matter content and its characteristics,
- the concentration of free Cu ions (the most bioavailable form), at ambient conditions, is regulated primarily by the complexation with strong ligands (L_1),
- for most of the samples, the calculated free Cu slightly exceeds the toxic threshold of 10 pM, which can have adverse effects on certain phytoplankton species, especially at the marina and anchorage sites. However, these values are the result of applied methodology of calculation, and does not necessarily reflect real ambient conditions,
- this study showed also that the observed range of trace metals in the Krka river remained at the same level as 30 years ago, confirming its very pristine status.

A more focused and detailed studies would be needed in order to fully explore and understand each of the observed specific TM behaviours and their effect onto TM chemical speciation and fate. Based on the summarized observations and findings, it could be concluded that the Krka River estuary hosts several particularities which make it a model site for studies on behaviour and fate of TM as well as of their biogeochemical cycle, representative for much larger coastal pristine aquatic systems, but also an open sea.

7. References

7. References

- Abe, K., Ishihi, Y., Watanabe, Y., 2003, Dissolved copper in the yellow sea and the East China Sea – Cu as a tracer of the changjiang discharge. *Deep-Sea Res. Part II*, v. 50, p. 327–337.
- Abril, G., Nogueira, M., Etcheber, H., Cabecadas, G., Lemaire, E., and Brogueira, M. J., 2002, Behaviour of organic carbon in nine contrasting European estuaries: *Estuarine, Coastal and Shelf Science*, v. 54, p. 241-262.
- Admiraal, W., Tubbing, G.M.J., Breebaart, L., 1995, Effects of phytoplankton on metal partitioning in the lower river Rhine, *Water Res.*, v. 29, p. 941–946.
- Al-Farawati, R., van den Berg, C.M.G., 1999, Metal-sulfide complexation in seawater, *Marine Chemistry*, v. 63, p. 331–352.
- Alvarez-Salgado, X.A., Miller, A.E.J., 1998, Dissolved organic carbon in a large macrotidal estuary (the Humber, UK): behaviour during estuarine mixing, *Mar. Pollut. Bull.*, v. 37, p. 216–224.
- Amon, R. M. W., Benner, R., 1996, Bacterial utilization of different size classes of dissolved organic matter: *Limnol. Oceanogr.*, v. 41, p. 41.
- Annibaldi, A., Illuminati, S., Truzzi, C., Scarponi, G., 2011, SWASV speciation of Cd, Pb and Cu for the determination of seawater contamination in the area of the Nicole shipwreck (Ancona coast, Central Adriatic Sea), *Mar. Pollut. Bull.* v. 62, p. 2813–2821.
- Avery Jr., G. B., Willey, J. D., and Kieber, R. J., 2003, Flux and bioavailability of Cape Fear River and rainwater dissolved organic carbon to Long Bay, southeastern United States: *Global Biogeochemical Cycles*, v. 17.
- Balch, J., Gueguen, C., 2015. Effects of molecular weight on the diffusion coefficient of aquatic dissolved organic matter and humic substances. *Chemosphere* 119, 498-503.
- Balistreri, L. S., Seal II, R. R., Piatak, N. M., Paul, B., 2007, Assessing the concentration, speciation, and toxicity of dissolved metals during mixing of acid mine drainage and ambient river water downstream of the Elizabeth Copper Mine, Vermont, USA: *Appl. Geochem.*, v. 22, p. 930-952.
- Benoit, G., Oktaymarshall, S.D., Cantu, A., Hood, E.M., Coleman, C.H., Corapcioglu, M.O., Santschi, P.H., 1994, Partitioning of Cu, Pb, Ag, Zn, Fe, Al, and Mn between filter-retained particles, colloids, and solution in 6 texas estuaries, *Marine Chemistry*, v. 45, p. 307–336.
- Bianchi, T. S., 2007, *Biogeochemistry of estuaries*, Oxford University press, p. 706.
- Biati, A., Karbassi, A. R., 2010, Comparison of controlling mechanisms of flocculation processes in estuaries: *International Journal of Environmental Science & Technology*, v. 7, no. 4, p. 731-736.
- Biati, A., Karbassi, A. R., Hassani, A. H., Monavari, S. M., and Moattar, F., 2010, Role of metal species in flocculation rate during estuarine mixing: *International Journal of Environmental Science & Technology*, v. 7, no. 2, p. 327-336.
- Bilinski, H., Kozar, S., Plavšić, M., Kwokal, Ž., Branica, M., 1991, Trace-Metal Adsorption on Inorganic Solid-Phases under Estuarine Conditions: *Marine Chemistry*, v. 32, p. 225-233.
- Bilinski, H., Kwokal, Z., Branica, M., 1996, Formation of some manganese minerals from ferromanganese factory waste disposed in the Krka River Estuary. *Water Res.*, v. 30, p. 495–500.
- Bilinski, H., Kwokal, Z., Plavšić, M., Wrischer, M., Branica, M., 2000, Mercury distribution in the water column of the stratified Krka river estuary (Croatia): importance of natural organic matter and of strong winds. *Water Res.*, v. 34, p. 2001–2010.

7. References

- Bourg, A.C.M., 1987, Trace-metal adsorption modeling and particle water interactions in estuarine environments, *Cont. Shelf Res.*, v. 7, p. 1319–1332.
- Boyle, E. A., Husted, S. S., Grant, B. C., 1982, The chemical mass balances of the amazon plume II. Copper, nickel and cadmium *Deep Sea Res.*, v. 29, p. 1355-1364.
- Bruland, K. W., 1989, Complexation of zinc by natural organic ligands in the central North Pacific: *Limnol. Oceanogr.*, v. 34, p. 269-285.
- Bruland, K. W., 1992, Complexation of cadmium by natural organic ligands in the central North Pacific: *Limnol. Oceanogr.*, v. 37, p. 1008-1017.
- Bruland, K. W., Rue, E. L., Donat, J. R., Skabal, S., Moffett, J. W., 2000, An intercomparison of voltammetric approaches to determine the chemical speciation of dissolved copper in a coastal seawater sample: *Anal. Chim. Acta*, v. 405, p. 99-113.
- Bruland, K. W., Rue, E. L., and Smith, G. J., 2001, The influence of iron and macronutrients in coastal upwelling regimes off central California: implications for extensive blooms of large diatoms: *Limnol. Oceanogr.*, v. 46, p. 1661-1674.
- Bruland, K. W., Lohan, M. C., 2004, The control of trace metals in seawater. *The Oceans and Marine Geochemistry, Treatise on Geochemistry*. H. Elderfield. Amsterdam, Elsevier. 6: 23-47.
- Bruland, K. W., Lohan, M. C., 2013, Controls of trace metals in seawater, in Holland, H. D., and Turekian, K. K., eds., *Treatise on geochemistry*: New Haven, Ct, USA, Yale University.
- Buck, K.N., Bruland, K.W., 2005, Copper speciation in San Francisco Bay: a novel approach using multiple analytical windows, *Marine Chemistry*, v. 96, p. 185–198.
- Buck, K. N., Ross, J. R. M., Russell Flegal, A., Bruland, K. W., 2007, A review of total dissolved copper and its chemical speciation in San Francisco Bay, California, *Environ. Res.*, v. 105, p.5–19.
- Buck, K.N., Moffett, J., Barbeau, K.A., Bundy, R.M., Kondo, Y., Wu, J. 2012, The organic complexation of iron and copper: an intercomparison of competitive ligand exchange-adsorptive cathodic stripping voltammetry (CLE-ACSV) techniques, *Limnol. Oceanogr. Methods*, vol. 10, p. 496-515
- Buffle, J., 1988, Complexation reactions in aquatic systems: an analytical approach, Chichester, Ellis Harwood, p. 700.
- Buffle, J., Van Leeuwen, H. P., 1992, Environmental particles. Volume 1., *Environmental analytical and physical chemistry series*: London, Lewis Publishers, p. 554.
- Cai, Y.H., Guo, L.D., Wang, X.R., Mojzic, A.K., Redalje, D.G., 2012, The source and distribution of dissolved and particulate organic matter in the Bay of St. Louis, northern Gulf of Mexico, *Estuarine Coastal and Shelf Science*, v. 96, p. 96–104.
- Campbell, P. G. C., 1995, Interactions between trace metals and aquatic organisms: A critique of the free-ion activity model, in Tessier, A., and Turner, D. R., eds., *Trace Metal Speciation and Bioavailability in Aquatic Systems*: Chichester, John Wiley & Sons., p. 45-102.
- Campbell, P. G. C., Errecaide, O., Fortin, C., Hiriart-Baer, V. P., Vigneault, B., 2002, Metal bioavailability to phytoplankton applicability of the biotic ligand model: *Comp. Biochem. Physiol., Part C.*, v. 133, p. 189-206.
- Campos, M.L.A.M., C.M.G. van den Berg, 1994. Determination of copper complexing ligand concentrations using cathodic stripping voltammetry with ligand competition by salicylaldoxime. *Anal. Chim. Acta*, v. 284, p. 481-496.
- Canavan, R.W., Van Cappellen, P., Zwolsman, J.J.G., van den Berg, G.A., Slomp, C.P., 2007, Geochemistry of trace metals in a fresh water sediment: field results and diagenetic modeling, *Sci. Total Environ.*, v. 381, p. 263–279.

- Capodaglio, G., Coale, K. H., Bruland, K. W., 1990, Lead speciation in surface waters of the eastern North Pacific: *Marine Chemistry*, v. 29, p. 221-238.
- Carlson, C. A., 2002, Production and removal processes, in Hansell, D. A., and Carlson, C. A., eds., *Biogeochemistry of Marine Dissolved Organic Matter*: San Diego, Academic Press, p. 91-151.
- Cauwet, G., 1991, Carbon inputs and biogeochemical processes at the halocline in a stratified estuary – Krka River, Yugoslavia, *Marine Chemistry*, v. 32, p. 269–283.
- Cetinić, I., Viličić, D., Burić, Ž., Olujčić, G., 2006, Phytoplankton seasonality in a highly stratified karstic estuary (Krka, Adriatic Sea), *Hydrobiologia*, v. 555, p. 31–40.
- Chang, L. Y., Davison, W., Zhang, H., Kelly, M., 1998, Performance characteristics for the measurement of Cs and Sr by diffusive gradients in thin films (DGT): *Anal Chim Acta*, v. 368, p. 243-253.
- Chiffoleau, J.F., Cossa, D., Auger, D., Truquet, I., 1994, Trace-metal distribution, partition and fluxes in the seine estuary (France) in low discharge regime, *Marine Chemistry*, v. 47, p. 145–158.
- Cindrić, A.-M., Garnier, C., Oursel, B., Pižeta, I., Omanović, D., Evidencing the natural and anthropogenic processes controlling trace metals dynamic in a highly stratified estuary: The Krka River estuary (Adriatic, Croatia), *Mar. Pollut. Bull.*, v. 94, p. 199-216
- Clarisse, O., Hintelmann, H., 2006, Measurements of dissolved methylmercury in natural waters using diffusive gradients in thin film (DGT): *J. Environ. Monit.*, v. 8, p. 1242-1247.
- Coale, K. H., Bruland, K. W., 1988, Copper complexation in the northeast Pacific: *Limnol. Oceanogr.*, v. 33, p. 1084-1101.
- Coale, K. H., Bruland, K. W., 1990, Spatial and temporal variability in copper complexation in the North Pacific: *Deep Sea Research*, v. 37, p. 317-336.
- Cobelo-Garcia, A., Prego, R., 2004, Chemical speciation of dissolved copper, lead and zinc in a ria coastal system: the role of resuspended sediments: *Anal Chim Acta*, v. 524, p. 109-114.
- Cobelo-Garcia, A., Prego, R., Labandeira, A., 2004, Land inputs of trace metals, major elements, particulate organic carbon and suspended solids to an industrial coastal bay of the NE Atlantic, *Water Res.*, v. 38, p. 1753–1764.
- Comans, R.N.J., Vandijk, C.P.J., 1988, Role of complexation processes in cadmium mobilization during estuarine mixing, *Nature*, v. 336, p. 151–154.
- Croot, P.L., Moffett, J.W., Luther, G.W., 1999, Polarographic determination of half-wave potentials for copper-organic complexes in seawater, *Marine chemistry*, v. 67, p. 219–232
- Cukrov, N., Cmuk, P., Mlakar, M., Omanović, D., 2008, Spatial distribution of trace metals in the Krka River, Croatia: an example of the self-purification: *Chemosphere*, v. 72, no. 10, p. 1559-1566.
- Cukrov, N., Frančičković-Bilinski, S., Mikac, N., Roje, V., 2008b, Natural and anthropogenic influences recorded in sediments from the Krka river estuary (Eastern Adriatic coast), evaluated by statistical methods, *Fresenius Environ. Bull.*, v. 17, p. 855–863.
- Dang, D.H., Lenoble, V., Durrieu, G., Omanović, D., Mullot, J.-U., Mounier, S., Garnier, C., 2015, Seasonal variations of coastal sedimentary trace metals cycling: insight on the effect of manganese and iron (oxy)hydroxides, sulphide and organic matter, *Mar. Pollut. Bull.*, v. 92, p. 113-124
- Dabrin, A., Schäfer, J., Blanc, G., Strady, E., Masson, M., Bossy, C., Castelle, S., Girardot, N., Coynel, A., 2009, Improving estuarine net flux estimates for dissolved cadmium export at the annual timescale: Application to the Gironde Estuary: *Estuarine, Coastal and Shelf Science*, v. 84, no. 4, p. 429-439.

7. References

- Dabrin, A., Roulier, J.L., Coquery, M., 2013, Colloidal and truly dissolved metal(oid) fractionation in sediment pore waters using tangential flow filtration, *Appl. Geochem.*, v. 31, p. 25–34.
- Dahlqvist, R., Andersson, K., Ingri, J., Larsson, T., Stolpe, B., Turner, D., 2007, Temporal variations of colloidal carrier phases and associated trace elements in a boreal river: *Geochim. Cosmochim. Acta*, v. 71, p. 5339-5354.
- Dai, M., Yin, Z., Meng, F., Liu, Q., Cai, W. J., 2012, Spatial distribution of riverine DOC inputs to the ocean: an updated global synthesis: *Environmental Sustainability*, v. 4, p. 170-178.
- Dai, M. H., Martin, J. M., 1995, First data on trace metal level and behaviour in two major Arctic river-estuarine systems (Ob and Yenisey) and in the adjacent Kara Sea, Russia: *Earth and Planetary Science Letters*, v. 131, p. 127-141.
- Dai, M. H., Martin, J. M., Cauwet, G., 1995, The significant role of colloids in the transport and transformation of organic carbon and associated trace metals (Cd, Cu and Ni) in the Rhone delta (France): *Marine Chemistry*, v. 51, p. 159-175.
- Dassenakis, M., Degaita, A., Scoullou, M., 1995, Trace-metals in sediments of a mediterranean estuary affected by human activities (Acheloos River Estuary, Greece), *Sci. Total Environ.*, v. 168, p. 19–31.
- Dassenakis, M., Scoullou, M., Gaitis, A., 1997, Trace metals transport and behaviour in the mediterranean estuary of acheloos river, *Mar. Pollut. Bull.*, v. 34, p. 103–111.
- Davison, W., Zhang, H., 1994, In situ speciation measurements of trace components in natural waters using thin film gels: *Nature*, v. 367, p. 546-548.
- Davison, W., Zhang, H., 2012, Progress in understanding the use of diffusive gradients in thin films (DGT)-back to basics: *Environ Chem*, v. 9, p. 1-13.
- Deycard, V.N., Schäfer, J., Blanc, G., Coynel, A., Petit, J.C.J., Lancelot, L., Dutruy, L., Bossy, C., Ventura, A., 2014, Contributions and potential impacts of seven priority substances (As, Cd, Cu, Cr, Ni, Pb, and Zn) to a major European Estuary (Gironde Estuary, France) from urban wastewater, *Marine Chemistry*, v. 167, p. 123–134.
- Di Toro, D. M., Allen, H. B., Meyer, J., Paquin, P., Santore, R., 2001, A Biotic Ligand Model of the Acute Toxicity of Metals: I. Technical Basis: *Environmental Toxicology and Chemistry*, v. 20, p. 2383-2396.
- Diaz-Cruz, J. M., Esteban, M., 1992, Stripping voltammetry of metal complexes: interferences from adsorption onto cell components.: *Anal. Chim. Acta*, v. 64, p. 1769-1776.
- Directive 2013/39/EU. Directive 2013/39/EU of the European Parliament and of the Council of 12 August 2013 amending Directives 2000/60/EC and 2008/105/EC as regards priority substances in the field of water policy. [Official J L 226/ 24/08/2013]; 2013
- Dixon, J. L., Helms, J. R., Kieber, R. J., and Brooks Avery Jr, G., 2014, Biogeochemical alteration of dissolved organic material in the Cape Fear River Estuary as a function of freshwater discharge: *Estuarine, Coastal and Shelf Science*, v. 149, p. 273-282.
- Dočekalová, H., Diviš, P., 2005, Application of diffusive gradient in thin films technique (DGT) to measurement of mercury in aquatic systems: *Talanta*, v. 65, p. 1174-1178.
- Donat, J. R., Van den Berg, C. M. G., 1992, A new cathodic stripping voltammetric method for determining organic complexation of copper in seawater: *Marine Chemistry*, v. 38, p. 69-90.
- Donat, J., Lao, K. A., Brunland, K. W., 1995, Speciation of dissolved Cu and Ni in South San Francisco Bay, a multi method approach: *Anal. Chim. Acta*, v. 284, p. 547-571.
- Dorten, W.S., Elbaz-Poulichet, F., Mart, L., Martin, J.M., 1991, Reassessment of river input of trace metals to the Mediterranean Sea. *Ambio* v. 20, p. 2–6.

- Duran, I., Nieto, O., 2011, Electrochemical speciation of dissolved Cu, Pb and Zn in an estuarine ecosystem (Ria de Vigo, NW Spain): comparison between data treatment methods, *Talanta*, v. 85, p. 1888–1896.
- Duran, I., Beiras, R., 2013, Ecotoxicologically based marine acute Water Quality Criteria for metals intended for protection of coastal areas, *Science of the Total Environment*, 463–464: 446–453.
- Dyer, K. R., 1989, Estuarine flow interaction with topography, lateral and longitudinal effects, in Neilson, B. J., Kuo, A., and Brubaker, J., eds., *Estuarine circulation: New Jersey, USA*, Humana press, p. 39-59.
- Dunn, R.J.K., 2007, Teasdale, P.R.; Warnken, J.; Arthur, J.M. Evaluation of the in situ, time-integrated DGT technique by monitoring changes in heavy metal concentrations in estuarine waters. *Environ Pollut.* 148:213-220;
- Džombak, D. A., Fish, W., Morrel, F. M. M., 1986, Metal Humate Interactions .1. Discrete Ligand and Continuous Distribution Models: *Environmental Science & Technology*, v. 20, no. 7, p. 669-675.
- Eaton, A., 1979, Observations on the geochemistry of soluble copper, iron, nickel and zinc in the San Francisco Bay estuary: *Environmental Science and Technology*, v. 13, p. 425-432.
- Eby, G. N., 2004, *Principles of environmental geochemistry*, USA, Thomas Learning, Inc.
- EcoChemie, 2004, General Purpose Electrochemical System (GPES) for Windows -version 4.9.005: Utrecht, The Netherlands, Eco Chemie.
- Elbaz-Poulichet, F., Holliger, P., Wei, W.H., Martin, J.M., 1984, Lead cycling in estuaries, illustrated by the Gironde estuary, France, *Nature* v. 308, p. 409–414.
- Elbaz-Poulichet, F., Martin, J. M., 1987, Dissolved Cd behaviour in some selected French and Chinese estuary. Consequences on Cd supply to the ocean: *Marine Chemistry*, v. 22, no. 125-136.
- Elbaz-Poulichet, F., Guan, D. M., Martin, J. M., 1991, Trace metal behaviour in highly stratified Mediterranean estuary: the Krka (Yugoslavia): *Marine Chemistry*, v. 32, p. 211-224.
- Elbaz-Poulichet, F., Garnier, J. M., Guan, D. M., Martin, J. M., Thomas, A. J., 1996, The conservative behaviour of trace metals (Cd, Cu, Ni and Pb) and As in the surface plume of stratified estuaries: example of the Rhone river (France): *Estuarine, Coastal and Shelf Science*, v. 42, p. 289-310.
- Elbaz-Poulichet, F., 2005, River Inputs of Metals and Arsenic, in Saliot, A., ed., *The Mediterranean Sea*, Volume 5K, Springer Berlin Heidelberg, p. 211-235.
- Ellwood, M. J., Van den Berg, C. M. G., 2000, Zinc speciation in the Northeastern Atlantic Ocean: *Marine Chemistry*, v. 68, p. 295-306.
- Ellwood, M. J., Van den Berg, C. M. G., 2001, Determination of organic complexation of cobalt in seawater by cathodic stripping voltammetry: *Marine Chemistry*, v. 75, p. 49-68.
- Fichet, D., Radenac, G., Miramand, P., 1998, Experimental studies of impacts of harbor sediments resuspension to marine invertebrates larvae: bioavailability of Cd, Cu, Pb and Zn and toxicity, *Marine Pollution Bulletin*, v. 36, p. 509-518.
- Florence, T. M., 1986, Electrochemical Approaches to trace element speciation in waters. A review: *Analyst*, v. 111, p. 489.
- Forsberg, J., 2006, Dahlqvist, R.; Gelting-Nystrom, J.; Ingri, J. Trace metal speciation in brackish water using diffusive gradients in thin films and ultrafiltration: Comparison of techniques. *Environ Sci Technol.* 40:3901-3905;

7. References

- French, M. A., Zhang, H., Pates, J. M., Bryan, S. E., Wilson, R. C., 2005, Development and performance of the diffusive gradients in thin-films technique for the measurement of technetium-99 in seawater: *Analytical Chemistry*, v. 77, p. 135-139.
- Fresco, J., Weiss, H. V., Phillips, R. B., Askeland, R. A., 1985, Iridium in sea-water: *Talanta*, v. 32, no. 8, Part 2, p. 830-831.
- Fu, J., Tang, X.-L., Zhang, J., Balzer, W., 2013, Estuarine modification of dissolved and particulate trace metals in major rivers of east-hainan, china: *Continental Shelf Res.*, v. 57, p. 59-72.
- Gaillardet, J., Viers, J., Dupre, B., 2013, Trace elements in river waters, in Holland, H. D., and Turekian, K. K., eds., *Treatise on Geochemistry: New Haven, CT, USA, Yale University*.
- Garmo, Ø. A., Røyset, O., Steinnes, E., Flaten, T. P., 2003, Performance Study of Diffusive Gradients in Thin Films for 55 Elements: *Analytical Chemistry*, v. 75, no. 14, p. 3573-3580.
- Garnier, C., Pižeta, I., Mounier, S., Benaïm, J. Y., Branica, M., 2004a, Influence of the type of titration and of data treatment methods on metal complexing parameters determination of single and multi-ligand systems measured by stripping voltammetry: *Anal. Chim. Acta*, v. 505, p. 263-275.
- Garnier, C., Mounier, S., Benaïm, J.Y., 2004b, Metal logarithmic scale titration as a tool for complexing ligand distribution determination: an application by DPASV. *Environ. Technol.*, v. 25, p. 589-599.
- Gerringa, L.J.A., Rijstenbil, J. W., Poortvliet, T. C. W., Vandrie, J., Schot, M. C., 1995. Speciation of copper and responses of the marine diatom *Ditylum brightwellii* upon increasing copper concentrations. *Aquat. Toxicol.*, v. 31, p. 77-90.
- Gerringa, L.J.A., Rijkenberg, M.J.A., Thuroczy, C.E., Maas, L.R.M., 2014, A critical look at the calculation of the binding characteristics and concentration of iron complexing ligands in seawater with suggested improvements, *Environmental Chemistry*, v. 11, p. 114-136.
- Gibbon-Walsh, K., Salaun, P., Van Den Berg, C.M.G., 2012, Pseudopolarography of copper complexes in seawater using a vibrating gold microwire electrode, *J. Phys. Chem. A*, v. 116, p. 6609-6620.
- Gimpel, J., Zhang, H., Hutchinson, W., Davison, W., 2001, Effect of solution composition, flow and deployment time on the measurement of trace metals by the diffusive gradient in thin films technique: *Anal. Chim. Acta*, v. 448, p. 93-103.
- Gordon, A. S., Donat, J. R., Kango, R. A., Dyer, B. J., Stuart, L. M., 2000, Dissolved copper-complexing ligands in cultures of marine bacteria and estuarine water: *Marine Chemistry*, v. 70, p. 149-160.
- Guo, L.D., White, D.M., Xu, C., Santschi, P.H., 2009, Chemical and isotopic composition of high-molecular-weight dissolved organic matter from the Mississippi River plume, *Marine Chemistry*, v. 114, p. 63-71.
- Hamilton-Taylor, J., Postill, A.S., Tipping, E., Harper, M.P., 2002, Laboratory measurements and modeling of metal – humic interactions under estuarine conditions, *Geochim. Cosmochim. Acta*, v.66, p. 403 – 415.
- Han, S.P., Zhang, Y., Masunaga, S., Zhou, S.Y., Naito, W., 2014. Relating metal bioavailability to risk assessment for aquatic species: Daliao River watershed, China. *Environ. Pollut.* 189, 215-222.
- Hartnett, H. E., Devol, A. H., 2003, Role of a strong oxygen-deficient zone in the preservation and degradation of organic matter: a carbon budget for the continental margins of northwest Mexico and Washington State: *Geochim. Cosmochim. Acta*, v. 67, p. 247-264.
- Hatje, V., Brich, G. F., and Hill, D. M., 2001, Spatial and Temporal Variability of Particulate Trace Metals in Port Jackson Estuary, Australia: *Estuarine, Coastal and Shelf Science*, v. 53, p. 63-77.
- Hatje, V., 2003, Particulate trace metal and major element distributions over consecutive tidal cycles in Port Jackson Estuary, Australia: *Environmental Geology*, v. 44, no. 2, p. 231-239.

- Hatje, V., Apte, S.C., Hales, L.T., Birch, G.F., 2003a, Dissolved trace metal distributions in Port Jackson estuary (Sydney Harbour), Australia, *Mar. Pollut. Bull.*, v. 46, p. 719-730.
- Hatje, V., Payne, T.E., Hill, D.M., McOrist, G., Birch, G.F., Szymczak, R., 2003b, Kinetics of trace element uptake and release by particles in estuarine waters: effects of pH, salinity, and particle loading, *Environ. Int.*, v. 29, p. 619–629.
- Hedges, J. I., 1992, Global biogeochemical cycles: progress and problems: *Marine Chemistry*, v. 39, p. 67-93.
- Hedges, J. I., Keil, R. G., 1995, Sedimentary organic matter preservations: an addesddment and speculative synthesis: *Marine Chemistry*, v. 49, p. 81-115.
- Hering, J. G., Morrel, F. M. M., 1990, *Aquatic Chemical Kinetics*, New York, Wiley-Interscience.
- Hirose, K., 1994, Conditional Stability-Constants of Metal-Complexes of Organic-Ligands in Sea-Water - Past and Present, and a Simple Coordination Chemistry Model: *Analytica Chimica Acta*, v. 284, no. 3, p. 621-634.
- Hirose, K., 2006, Chemical Speciation of Trace Metals in Seawater: a Review: *Analytical Science*, v. 22, p. 1055-1063
- Hirose, K., 2007, Metal organic matter interactions: Ecological roles of ligands in oceanic DOM: *Applied Geochemistry*, v. 22, p. 1636-1645.
- Hopkins, C. S., Buffam, I., Hobbies, J., Vallino, J., Perdue, M., Eversmeyer, B., Prahl, F., Covert, J., Hodson, R., Moran, M. A., Smith, E., Baross, J., Crump, B., Findlay, S., Foreman, K., 1997, Terrestrial inputs of organic matter to coastal ecosystems: an intercalibration of chemical characteristics and bioavailability: *Biogeochemistry*, v. 43, p. 211-234.
- Hubner, R., Astin, K., Herbert, R., 2010, ‘Heavy metal’—time to move on from semantics to pragmatics?, *Journal of Environmental Monitoring*, v. 12, p. 1511-1514.
- Hudson, R.J.M., Rue, E.L., Bruland, K.W., 2003, Modeling complexometric titrations of natural water samples, *Environ. Sci. Technol.*, v. 37, p. 1553–1562.
- Hudson, N., Baker, A., Reynolds, D., 2007, Fluorescence analysis of dissolved organic matter in natural, waste and polluted waters-a review: *River research and applications*, v. 23, p. 631-649.
- Hunter, K. A., 1997, Chemistry of the sea-surface microlayer, in: *The sea-surface and global change*, edited by: Liss, P. S. and Duce, R. A., Cambridge University Press, Cambridge, 287–320.
- Huser, B. J., Kohler, S. J., Wilander, A., Johansson, K., Folster, J., 2011, Temporal and spatial trends for trace metals in streams and rivers across Sweden (1996–2009): *Biogeoscience*, v. 8, p. 1813-1823.
- Janssen, D.J., Conway, T.M., John, S.G., Christian, J.R., Kramer, D.I., Pedersen, T.F., Cullen, J. T., 2014, Undocumented water column sink for cadmium in open ocean oxygen-deficient zones, *Proc Natl Acad Sci U S A*, v. 111, p. 6888-6893.
- Jean, N., Dumont, E., Durrieu, G., Balliau, T., Jamet, J.L., Personnic, S., Garnier, C., 2012. Protein expression from zooplankton communities in a metal contaminated NW mediterranean coastal ecosystem. *Mar. Environ. Res.* 80, 12-26.
- Jiann, K.T., Wen, L.S., Santschi, P.H., 2005, Trace metal (Cd, Cu, Ni and Pb) partitioning, affinities and removal in the Danshuei River estuary, a macro-tidal, temporally anoxic estuary in Taiwan, *Marine Chemistry*, v. 96, p. 293–313.
- Khlebovich, V. V., 1990, Some physico-chemical and biological phenomena in the salinity gradient: *Limnologica*, v. 20, p. 5-8.

7. References

- Kniewald, G., Kwokal, Z., Branica, M., 1987. Marine sampling by Scuba Diving. 3. Sampling procedures for measurement of mercury concentrations in estuarine waters and seawater. *Mar. Chem.*, v. 22, p. 343–352.
- Koshikawa, M. K., Takamatsu, T., Takada, J., Zhu, M., Xu, B., Chen, Z., Murakami, S., Xu, K., Watanabe, M., 2007, Distributions of dissolved and particulate elements in the Yangtze estuary in 1997–2002: Background data before the closure of the Three Gorges Dam: *Estuarine, Coastal and Shelf Science*, v. 71, no. 1–2, p. 26–36.
- Kozelka, P. B., Sanudo-Wilhelmy, S., Flegal, A. R., Bruland, K. W., 1997, Characterization of Cu(II)-binding ligands from Chesapeake Bay using high-performance size-exclusion chromatography and mass spectrometry: *Estuarine, Coastal and Shelf Science*, v. 44, p. 649–658.
- Kozelka, P. B., Bruland, K. W., 1998, Chemical speciation of dissolved Cu, Zn, Cd, Pb in Narragansett Bay, Rhode Island: *Marine Chemistry*, v. 60, p. 267–282.
- Kraepiel, A.M.L., Chiffoleau, J.F., Martin, J.M., Morel, F.M.M., 1997, Geochemistry of trace metals in the Gironde estuary. *Geochim. Cosmochim. Acta*, v. 61, p. 1421–1436.
- La Rosa, T., Mirtoa, S., Favaloroa, E., Savonaa, B., Sara, G., Danovarob, R., Mazzolaa, A., 2002, Impact on the water column biogeochemistry of a Mediterranean mussel and fish farm, *Water Research*, v. 36, p. 713–721
- Lead, J. R., Davison, W., Hamilton-Taylor, J., Buffle, J., 1997, Characterizing colloidal material in natural waters: *Aquatic Geochemistry*, v. 3, p. 213–232.
- Legović, T., 1991, Exchange of water in a stratified estuary with an application to Krka (Adriatic Sea), *Marine Chemistry*, v. 32, p. 121–135.
- Legović, T., Gržetić, Z., Žutić, V., 1991b, Subsurface temperature maximum in a stratified estuary. *Mar. Chem.* 32, 163–170.
- Legović, T., Petricioli, D., Žutić, V., 1991c, Hypoxia in a pristine stratified estuary (Krka, Adriatic Sea), *Marine Chemistry*, v. 32, p. 347–359.
- Legović, T., Viličić, D., Petricioli, D., Žutić, V., 1991d, Subsurface gonyaulax-polyedra bloom in a stratified estuary, *Marine Chemistry*, v. 32, p. 361–374.
- Legović, T., Žutić, V., Gržetić, Z., Cauwet, G., Precali, R., Viličić, D., 1994, Eutrophication in the Krka Estuary, *Marine Chemistry*, v. 46, p. 203–215.
- Levy, J. L., Zhang, H., Davison, W., Puy, J., Galceran, J., 2012, Assessment of trace metal binding kinetics in the resin phase of diffusive gradients in thin films: *Anal. Chim. Acta*, v. 717, p. 143–150.
- Li, W., Li, C., Zhao, J., Cornett, R. J., 2007, Diffusive gradients in thin films technique for uranium measurements in river water: *Anal. Chim. Acta*, v. 592, p. 106–113.
- Lohan, M. C., Statham, P. J., Crawford, D. W., 2002, Dissolved zinc in the upper water column of the subarctic North East Pacific.: *Deep Sea Research*, v. 49, p. 5793–5808.
- Lorenzo, J. I., Nieto, O., Beiras, R., 2002, Effect of humic acids on speciation and toxicity of copper to *Paracentrotus lividus* larvae in seawater: *Aquatic Toxicology*, v. 58, no. 1–2, p. 27–41.
- Lorenzo, J.I., Nieto-Cid, M., Alvarez-Salgado, X.A., Perez, P., Beiras, R., 2007, Contrasting complexing capacity of dissolved organic matter produced during the onset, development and decay of a simulated bloom of the marine diatom *Skeletonema costatum*, *Marine Chemistry*, v. 103, p. 61–75.
- Lorrain, A., Savoye, N., Chauvaud, L., Paulet, Y. M., Naulet, N., 2003, Decarbonation and preservation method for the analysis of organic C and N contents and stable isotope ratios of low-carbonated suspended particulate material: *Anal Chem Acta*, v. 491, p. 125–133.

- Louis, Y., Cmok, P., Omanović, D., Garnier, C., Lenoble, V., Mounier, S., Pižeta, I., 2008, Speciation of trace metals in natural waters: The influence of an adsorbed layer of natural organic matter (NOM) on voltammetric behaviour of copper: *Anal. Chim. Acta*, v. 606, no. 1, p. 37-44.
- Louis, Y., Garnier, C., Lenoble, V., Mounier, S., Cukrov, N., Omanović, D., Pižeta, I., 2009, Kinetic and equilibrium studies of copper-dissolved organic matter complexation in water column of the stratified Krka River estuary (Croatia): *Marine Chemistry*, v. 114, p. 110-119.
- Lourino-Cabana, B., Lesven, L., Charriau, A., Billon, G., Ouddane, B., Boughriet, A., 2011, Potential risks of metal toxicity in contaminated sediments of Deule river in Northern France, *J. Hazard. Mater.*, v. 186, p. 2129–2137.
- Lovrić, M., Mađer, T., Branica, M., 1984, Electrochemical kinetic measurements and metal speciation with the vibrating dropping mercury electrode, *Croat. Chem. Acta*, v. 57, p. 153-163.
- Lyvén, B., Hassellöv, M., Turner, D. R., Haraldsson, C., Andersson, K., 2003, Competition between iron- and carbon-based colloidal carriers for trace metals in a freshwater assessed using flow field-flow fractionation coupled to ICPMS.: *Geochim. Cosmochim. Acta*, v. 67, p. 3791-3802.
- MacCarthy, P., Malcolm, R. L., Clapp, C. E., Bloom, P. R., 1990, in MacCarthy, P., Malcolm, R. L., Clapp, C. E., and Bloom, P. R., eds., *Humic substances in soil and crop science: selected readings*: Madison, American Society of Agronomy.
- Mannino, A., Harvey, H. R., 2000, Biochemical composition of particles and dissolved organic matter along an estuarine gradient: Sources and implications for DOM reactivity: *Limnol. Oceanogr.*, v. 54, p. 775.
- Martino, M., Turner, A., Nimmo, A., Millward, G.E., 2002, Resuspension, reactivity and recycling of trace metals in the Mersey Estuary, UK, *Marine Chemistry*, v. 77, p. 171–186.
- McDonald, S., Bishop, A. G., Prenzler, P. D., Robards, K., 2004, Analytical chemistry of freshwater substances: *Anal. Chim. Acta*, v. 527, p. 105-124.
- McLusky, D. S., Elliot, M., 2004, *The estuarine ecosystem: ecology, threats and management*, Oxford, University Press.
- Meylan, S., Odzak, N., Behra, R., Sigg, L., 2004. Speciation of copper and zinc in natural freshwater: comparison of voltammetric measurements, diffusive gradients in thin films (DGT) and chemical equilibrium models. *Anal. Chim. Acta* 510, 91-100.
- Michel, P., Boutier, B., Chiffolleau, J. F., 2000, Net Fluxes of Dissolved Arsenic, Cadmium, Copper, Zinc, Nitrogen and Phosphorus from the Gironde Estuary (France): Seasonal Variations and Trends: *Estuarine, Coastal and Shelf Science*, v. 51, no. 4, p. 451-462.
- Millward, G. E., Turner, A., 1995, Trace metals in estuaries, in Salbu, B., and Steinnes, E., eds., *Trace elements in natural waters*: Boca Raton, FL, CRC Press, p. 223-245.
- Moffett, J. W., Brand, L. E., 1996, Production of strong, extracellular Cu chelators by marine cyanobacteria in response to Cu stress, *Limnol. Oceanogr.*, v. 41, p. 388-395.
- Moffett, J. W., Brand, L. E., Croot, P. L., a Barbeau, K. A., 1997, Cu speciation and cyanobacterial distribution in harbors subject to anthropogenic Cu inputs: *Limnol. Oceanogr.*, v. 42, p. 789-799.
- Moffett, J. W., Brand, L. E., Zika, R. G., 1990, Distribution and potential sources and sinks of copper chelators in the Sargasso Sea: *Deep Sea Research*, v. 37, p. 27-36.
- Monbet, P., 2006, Mass balance of lead through a small macrotidal estuary: the Morlaix River estuary (Brittany, France): *Marine Chemistry*, v. 98, p. 59-80.

7. References

- Monticelli, D., Dossi, C., Castelletti, A., 2010, Assessment of accuracy and precision in speciation analysis by competitive ligand equilibration–cathodic stripping voltammetry (CLE–CSV) and application to Antarctic samples, *Analytica Chimica Acta* v. 675, p. 116-124.
- Moran, M. A., Sheldon, W. M., Sheldon, J. E., 1999, Biodegradation of riverine dissolved organic carbon in five estuaries of the Southeastern United States: *Estuaries*, v. 22, p. 55-64.
- Morrel, F. M. M., Hering, J. G., 1993, Principles and applications of aquatic chemistry, New York, Wiley.
- Morrel, F. M. M., Džombak, D. A., Price, N. M., 1991, Heterogeneous reactions in coastal waters, in Mantoura, R. F. C., Martin, J. M., and Wollast, R., eds., *Ocean Margin Processes in Global Change*: New York, John Wiley, p. 165-180.
- Morris, A.W., Mantoura, R.F.C., Bale, A.J., Howland, R.J.M., 1978, Very low salinity regions of estuaries: important sites for chemical and biological reactions, *Nature*, v. 274, p. 678–680.
- Muller, F. L. L., 1996, Interactions of copper, lead and cadmium with the dissolved, colloidal and particulate components of estuarine and coastal waters: *Marine Chemistry*, v. 52, p. 245-268
- Muller, F. L. L., 1999, Evaluation of the effects of natural dissolved and colloidal organic ligands on the electrochemical lability of Cu, Pb, and Cd in the Arran Deep, Scotland: *Marine Chemistry*, v. 67, p. 43-60.
- Muller, F. L. L., Gulin, S. B., Kalvoy, A., 2001, Chemical speciation of copper and zinc in surface waters of the western Black Sea: *Marine Chemistry*, v. 76, p. 233-251.
- Mungkung, R., Upatham, E. S., Pokethitiyook, P., Kruatrachue, M., Panichajakul, C., 2001, Effect of humic acid and water hardness on acute toxicity and accumulation of Cd in the freshwater fish (*Puntius gonionotus* Bleeker): *Science Asia*, v. 27, p. 157-164.
- Munksgaard, N.C., Parry, D.L., 2001, Trace metals, arsenic and lead isotopes in dissolved and particulate phases of North Australian coastal and estuarine seawater, *Marine Chemistry*, v. 75, p. 165–184.
- Neira, C., Delgadillo-Hinojosa, F., Zirino, A., Mendoza, G., Levin, L.A., Porrachia, M., Deheyn, D.D., 2009, Spatial distribution of copper in relation to recreational boating in a California shallow-water basin, *Chem. Ecol.*, v. 25, p. 417–433
- Nolting, R. F., Helder, W., De Baar, H. J. W., Gerringa, L. J. A., 1999, Contrasting behaviour of trace metals in the Scheldt estuary in 1978 compared to recent years: *Journal of Sea Research*, v. 42, p. 275-290.
- Nordstrom, D. K., 2003, Modeling low-temperature geochemical processes, in Holland, H. D., and Turekian, K. K., eds., *Treatise on Geochemistry*: New Haven, CT, USA, Yale University.
- Nürnberg, H. W., 1977, Potentialities and application of advanced polarographic and voltammetric methods in environmental research and surveillance of toxic metals: *Electrochim. Acta*, v. 22, p. 935.
- Ollivier, P., Radakovitch, O., Hamelin, B., 2011, Major and trace element partition and fluxes in the Rhone River. *Chem. Geol.* v. 285, p. 15–31.
- Omanović, D., Pižeta, I., Peharec, Ž., Branica, M., 1996, Voltammetric determination of the metal complexing capacity in model solutions: *Marine Chemistry*, v. 53, p. 121-129.
- Omanović, D., Branica, M., 1998, Automation of Voltammetric Measurements by Polarographic Analyser PAR 384B: *Croat. Chem. Acta*, v. 71, no. 421-433.
- Omanović, D., Branica, M., 2003, Pseudopolarography of trace metals — part I. The automatic ASV measurements of reversible electrode reactions. *J. Electroanal. Chem.*, v. 543, p. 83–92.

- Omanović, D., Branica, M., 2004, Pseudopolarography of trace metals. Part II. The comparison of the reversible, quasireversible and irreversible electrode reactions. *J. Electroanal. Chem*, v. 565, p. 37–48.
- Omanović, D., Kwokal, Ž., Goodwin, A., Lawrence, A., Banks, C. E., Compton, R. G., Komorsky-Lovrić, Š., 2006, Trace metal detection in Sibenik Bay, Croatia: cadmium, lead and copper with anodic stripping voltammetry and manganese via sonoelectrochemistry. A case study: *J. Iran Chem. Soc.*, v. 3, p. 128-139.
- Omanović, D., Garnier, C., Louis, Y., Lenoble, V., Mounier, S., Pižeta, I., 2010. Significance of data treatment and experimental setup on the determination of copper complexing parameters by anodic stripping voltammetry. *Anal. Chim. Acta.* 664 (2), 136–143.
- Omanović, D., Garnier, C., Pižeta, I., 2015, ProMCC: An all-in-one tool for trace metal complexation studies, *Marine Chemistry*, v. 173, p. 25-39.
- Omanović, D., Pižeta, I., Vukosav, P., Kovacs, E., Frančičković-Bilinski, S., Tamas, J., 2015. Assessing element distribution and speciation in a stream at abandoned Pb-Zn mining site by combining classical, in-situ DGT and modelling approaches. *Sci. Total Environ.* 511, 423-434.
- Osterlund, H., Chlot, S., Faarinen, M., Winderlund, A., Rodushkin, I., Ingri, J., Baxter, D. C., 2010, Simultaneous measurements of As, Mo, Sb, V and W using a ferrihydrite diffusive gradients in thin films (DGT) device: *Anal. Chim. Acta*, v. 682, p. 59-65.
- Oursel, B., Garnier, C., Durrieu, G., Mounier, S., Omanović, D., Lucas, Y., 2013, Dynamics and fates of trace metals chronically. Input in a mediterranean coastal zone impacted by a large urban area: *Marine Pollution Bulletin*, v. 69, p. 137-149.
- Oursel, B., Garnier, C., Zebracki, M., Durrieu, G., Pairaud, I., Omanović, D., Cossa, D., Lucas, Y., 2014, Flood inputs in a mediterranean coastal zone impacted by a large urban area: dynamic and fate of trace metals, *Marine Chemistry*, v. 167, p. 44–56.
- Ouseph, P.P., 1992, Dissolved and particulate trace-metals in the Cochin estuary, *Mar. Pollut. Bull.*, v. 24, p. 186–192.
- Owens, R. E., Balls, P. W., 1997, Dissolved trace metals in the Tay estuary: *Estuarine, Coastal and Shelf Science*, v. 44, p. 421-434.
- Panther, J., Stillwell, K. P., Powell, K. J., Downard, A. J., 2008, Development and application of the diffusive gradients in thin films technique for the measurement of total dissolved inorganic arsenic in waters: *Anal. Chim. Acta*, v. 622, p. 133-142.
- Paucot, H., Wollast, R., 1997, Transport and transformation of trace metals in the Scheldt estuary, *Marine Chemistry*, v. 58, p. 229–244.
- Paulson, A.J., Curl, H.C., Gendron, J.F., 1994, Partitioning of Cu in Estuarine waters. 1. Partitioning in a poisoned system, *Marine Chemistry*, v. 45, p. 67–80.
- Penttinen, S., 2010, Bioavailability and toxicity of chemicals in inland waters: the importance of prevailing water chemistry and implications for risk assessment, *Disertation: University of Helsinki*.
- Perret, D., Gaillard, J. F., Dominik, J., Atteia, O., 2000, The diversity of natural hydrous iron oxides: *Environmental Science and Technology*, v. 34, p. 3540-3546.
- Petricioli, D., BakranPetricioli, T., Viličić, D., Požar Domac, A., 1996, Freshwater phytoplankton bloom in Visovac lake – a possible cause of benthic mortality in Krka estuary (Adriatic sea, Croatia), *PSZNI Mar. Ecol.*, v. 17, p. 373–382.
- Piccolo, A., 2001, The supramolecular structure of humic substances: *Soil Science*, v. 166, p. 810-832.
- Pitchette, C., Zhang, H., Davison, W., Sauvé, S., 2007, Preventing biofilm development on DGT devices using metals and antibiotics: *Talanta*, v. 72, p. 716-722.

7. References

- Pižeta, I., Branica, M., 1997, Simulation and fitting of anodic stripping voltammetry data for determination of the metal complexing capacity: *Anal. Chim. Acta*, v. 351, p. 73-82.
- Pižeta, I., Omanović, D., Branica, M., 1999, The influence of data treatment on the interpretation of experimental results in voltammetry, *Analytica Chimica Acta*, v. 401, p. 163–172.
- Pižeta, I., Sander, S.G., Hudson, R.J.M., Omanović, D., Baars, O., Barbeau, K.A., Buck, K.N., Bundy, R.M., Carrasco G., Croot, P.L., Garnier, C., Gerringa, L.J.A., Gledhill, M., Hirose, K., Kondo, Y., Laglera, L.M., Nuester, J., Rijkenberg, M.J.A., Takeda, S., Twining, B.S., Wells, M., 2015, Interpretation of complexometric titration data: An intercomparison of methods for estimating models of trace metal complexation by natural organic ligands, *Marine Chemistry*, v. 173, p. 3-24.
- Plavšić, M., Krznarić, D., Branica, M., 1982, Determination of the apparent copper complexing capacity of seawater by ASV. *Marine Chemistry*, v. 11, p. 17-31.
- Plavišić, M., Bilinski, H., Branica, M., 1987. Voltammetric Study of Adsorption of Cu(II) Species on Solid Particles Added to Seawater. *Mar. Chem.* 21, 151-160.
- Plavšić, M., Gašparović, B., Strmečki, S., Vojvodić, V., Tepić, N., 2009, Copper complexing ligands and organic matter characterization in the northern Adriatic Sea, *Estuarine, Coastal and Shelf science*, V. 85, p. 299-306
- Powell, R. T., Landing, W. M., and Bauer, J. E., 1996, Colloidal trace metals, organic carbon and nitrogen in southeastern U.S. estuary: *Marine Chemistry*, v. 55, p. 165-176.
- Raymond, P. A., Bauer, J. E., 2000, Bacterial consumption of DOC during transport through a temperate estuary: *Aquatic Microbial Ecology*, v. 22, p. 1-12.
- Rigaud, S., Radakovitch, O., Couture, R.M., Deflandre, B., Cossa, D., Garnier, C., Garnier, J.M., 2013, Mobility and fluxes of trace elements and nutrients at the sediment-water interface of a lagoon under contrasting water column oxygenation conditions, *Appl. Geochem.*, v. 31, p. 35–51.
- Robert, S., Blanc, G., Schafer, J., Lavaux, G., Abril, G.L., 2004, Metal mobilization in the Gironde Estuary (France): the role of the soft mud layer in the maximum turbidity zone, *Marine Chemistry*, v. 87, p. 1–13.
- Ružić, I., 1982, Theoretical aspects of the direct titration of natural waters and its information yield for trace metal speciation.: *Anal. Chim. Acta*, v. 140, p. 99-113.
- Saito, M. A., Moffett, J. W., 2001, Complexation of cobalt by natural organic ligands in the Sargasso Sea as determined by a new high-sensitivity electrochemical cobalt speciation method suitable for open ocean work: *Marine Chemistry*, v. 75, p. 69-88.
- Sander, S.G., Buck, K.N., Wells, M., 2015, The effect of natural organic ligands on trace metal speciation in San Francisco Bay: Implications for water quality criteria, *Marine Chemistry*, V. 173, p. 269-281.
- Sangi, M. R., Halstead, M. J., Hunter, K. A., 2002, Use of the diffusion gradient thin film method to measure trace metals in fresh waters at low ionic strength: *Anal. Chim. Acta*, v. 456, p. 241-251.
- Santore, R.C., Di Toro, D.M., Paquin, P.R., Allen, H.E., Meyer, J.S., 2001, A biotic ligand model of the acute toxicity of metals. II. Application to acute copper toxicity in freshwater fish and daphnia, *Environ. Toxicol. Chem*, v. 20, p. 2397–2402
- Santos-Echeandía, J., Laglera, L., M., Prego, R., Van den Berg, C. M. G., 2008, Dissolved copper speciation behaviour during estuarine mixing in the San Simon Inlet (wet season, Galicia). Influence of particulate matter: *Estuarine, Coastal and Shelf Science*, v. 76, p. 447-453.

- Santschi, P. H., Lenhart, J. J., Honeyman, B. D., 1997, Heterogeneous processes affecting trace contaminant distribution in estuaries: the role of natural organic matter: *Marine Chemistry*, v. 58.
- Scally, S., Davison, W., and Zhang, H., 2003, In situ measurement of dissociation kinetics and labilities of metal complexes in solution using DGT: *Environ. Sci. Technol.*, v. 37, p. 1379-1384.
- Scally, S., Davison, W., Zhang, H., 2006, Diffusion coefficients of metals and metal complexes in hydrogels used in diffusive gradients in thin films: *Anal. Chim. Acta*, v. 558, no. 1–2, p. 222-229.
- Scatchard, G., 1949, The attraction of proteins for small molecules and ions. *Ann. N. Y. Acad. Sci.*, v. 57, p. 660–672
- Schilling, K., Zessner, M., 2011, Foam in the aquatic environment, *Water Research*, v. 45, p. 4355-4366.
- Scribe, P., Filiaux, J., Laureillard, J., Denant, V., Saliot, A., 1991, Fatty acids as biomarkers of planktonic inputs in the stratified estuary of the Krka River, Adriatic Sea: Relationship with pigments: *Marine Chemistry*, v. 32, p. 299-312.
- Sedlak, D. L., Hoigné, J., David, M. M., Colville, R. N., Seyffer, E., Acker, K., Wiepercht, W., Lind, J. A., Fuzzi, S., 1997, The cloudwater chemistry of iron and copper at Great Dun Fell, UK, *Atmos. Environ.*, v. 31, p. 2515–2526
- Sempere, R., Cauwet, G., 1995, Occurrence of organic colloids in the stratified estuary of the Krka River (Croatia), *Estuarine Coastal and Shelf Science*, v. 40, p. 105–114.
- Shafer, M. M., Overdier, J. T., Hurley, J. P., Armstrong, J., and Webb, D., 1997, The influence of dissolved organic carbon, suspended particulates, and hydrology on the concentration, partitioning and variability of trace metals in two contrasting Wisconsin watersheds (USA). *Chem. Geol.*, v. 136, p. 71-97.
- Shank, G. C., Skrabal, S. A., Whitehead, R. F., Kieber, R. J., 2004, Strong copper complexation in an organic-rich estuary: the importance of allochthonous dissolved organic matter: *Marine Chemistry*, v. 88, p. 21-39.
- Shim, M. J., Swarzenski, P. W., and Shiller, A. M., 2012, Dissolved and colloidal trace elements in the Mississippi River delta outflow after Hurricanes Katrina and Rita: *Continental Shelf Res.*, v. 42, p. 1-9.
- Shynu, R., Rao, V. P., Kessarka, P. M., and Rao, T. G., 2012, Temporal and spatial variability of trace metals in suspended matter of the Mandovi estuary, central west coast of India: *Environ. Earth Sci.*, v. 65, p. 725-739.
- Singh, N., Turner, A., 2009a, Leaching of copper and zinc from spent antifouling paint particles, *Environmental Pollution*, v. 157, p. 371–376.
- Singh, N., Turner, A., 2009b., Trace metals in antifouling paint particles and their heterogeneous contamination of coastal sediments, *Marine Pollution Bulletin*, v. 58, p. 559–564.
- Skoog, D. A., West, D. M., Holler, F. J., 1996, *Fundamentals of analytical chemistry*, Fort Worth, Tex., Saunders College Pub.
- Smedley, P. L., Kinniburgh, D. G., 2002, A review of the source, behavior and distribution of arsenic in natural waters: *Appl. Geochem.*, v. 17, p. 517-568.
- Sogn, T. A., Eich-Greatorex, S., Røyset, O., Øgaard, A. F., Almås, Å. R., 2008, Use of diffusive gradients in thin films to predict potentially bioavailability selenium in soil: *Comm. Soil Sci. Plant Anal.*, v. 39, p. 587-602.

7. References

- Stockdale, A., Davison, W., Zhang, H., 2008, High-resolution two-dimensional quantitative analysis of phosphorus, vanadium and arsenic, and qualitative analysis of sulfide, in freshwater sediment: *Environ. Chem*, v. 5, p. 143-149.
- Stockdale, A., Davison, W., Zhang, H., 2010, 2D simultaneous measurements of the oxyanions of P, V, As, Mo, Sb, W and U: *J. Environ. Monit.*, v. 12, p. 981-984.
- Stumm, W., 1993, Aquatic colloids as chemical reactants: surface structure and reactivity: *Coll. Surf.*, v. A73, p. 1-18.
- Stumm, W., Morgan, J. J., 1996, *Aquatic chemistry: Chemical equilibria and rates in natural waters*, New York, Wiley.
- Sunda, W. G., and Guillard, R. R. L., 1976, Relationship between Cupric Ion Activity and Toxicity of Copper to Phytoplankton: *Journal of Marine Research*, v. 34, no. 4, p. 511-529.
- Sunda, W. G., Tester, P. A., Huntsman, S. A., 1987, Effects of cupric and zinc ion activities on the survival and reproduction of marine copepods: *Mar. Biol.*, v. 94, p. 203-210.
- Sunda, W. G., 1994, Trace Metal Phytoplankton interaction in the Sea, in Bidogli, G., and Stumm, W., eds., *Chemistry of Aquatic Systems, local and Global Perspectives*, Kluwer, p. 213-237.
- Sunda, W. G., Huntsman, S. A., 1995, Regulation of Copper Concentration in the Oceanic Nutricline by Phytoplankton Uptake and Regeneration Cycles: *Limnology and Oceanography*, v. 40, no. 1, p. 132-137.
- Svensen, C., Viličić, D., Wassmann, P., Arashkevich, E., Ratkova, T., 2007, Plankton distribution and vertical flux of biogenic matter during high summer stratification in the Krka estuary (Eastern Adriatic). *Estuar. Coast. Shelf Sci.* 71, 381–390.
- Tahir, N. M., Suratman, S., Shazili, N. A. M., Ariffin, M. M., Amin, M. S. M., Ariff, N. F., M.N.I., Sulaiman, W. N. H. W., 2008, Behaviour of water quality parameters during ebb tide in Dungun River estuary, Terengganu: *Journal of Sustainability Science and Management*, v. 3, no. 1, p. 1-10.
- Takata, H., Aono, T., Tagami, K., Uchida, S., 2010, Processes controlling cobalt distribution in two temperate estuaries, Sagami Bay and Wakasa Bay, Japan, *Estuarine Coastal and Shelf Science*, v. 89, p. 294–305.
- Tang, D., Warnken, K. W., Santschi, P. H., 2001, Organic complexation of copper in surface waters of Galveston Bay: *Limnol. Oceanogr.*, v. 46, p. 321-330.
- Tang, D., Warnken, K. W., Santschi, P. H., 2002, Distribution and partitioning of trace metals (Cd, Cu, Ni, Pb, Zn) in Galveston Bay waters: *Marine Chemistry*, v. 78, p. 29-45.
- Tankere, S.P.C., Statham, P.J., 1996, Distribution of dissolved Cd, Cu, Ni and Zn in the Adriatic Sea. *Mar. Pollut. Bull.*, v. 32, p. 623–630.
- Telesh, I. V., Khlebovich, V. V., 2010, Principal processes within the estuarine salinity gradient: a review: *Marine Pollution Bulletin*, v. 61, p. 149-155.
- Templeton, D. M., Ariese, F., Cornelis, R., Danielsson, L. G., Muntau, H., Van Leeuwen, H. P., Lobinski, R., 2000, Guidelines for terms related to chemical speciation and fractionation of elements. Definitions, Structural aspects and methodological approaches (IUPAC Recommendations 2000): *Pure Appl. Chem.*, v. 72, p. 1453-1470.
- Tessier, A.; Turner, D.R. *Metal Speciation and Bioavailability in Aquatic Systems*: John Wiley & Sons, Chichester, UK; 1996
- Town, R.M., Chakraborty, P., van Leeuwen, H.P., 2009, Dynamic DGT speciation analysis and applicability to natural heterogeneous complexes, *Environ. Chem.*, v. 6, p. 170-177

- Truesdale, V.W., Žic, V., Garnier, C., Cukrov, N., 2012. Circumstantial evidence in support of org-I as a component of the marine aerosol arising from a study of marine foams, *Estuarine, Coastal and Shelf Science* v. 115, p. 388-398
- Turekian, K. K., 1977, The fate of metals in the oceans: *Geochim. Cosmochim. Acta*, v. 41, p. 1139-1144.
- Turner, A., 1996, Trace-metal partitioning in estuaries: importance of salinity and particle concentration, *Marine Chemistry*, v. 54, p. 27–39.
- Turner, A., Nimmo, M., Thuresson, K. A., 1998, Speciation and sorptive behaviour of nickel in an organic-rich estuary (Beaulieu, UK): *Marine Chemistry*, v. 63, no. 1–2, p. 105-118.
- Turner, A., Millward, G. E., 2002, Suspended particles: Their role in estuarine biogeochemical cycles: *Estuarine, Coastal and Shelf Science*, v. 55, p. 857-883.
- Turner, A., Millward, G. E., Le Roux, S. M., 2004, Significance of oxides and particulate organic matter in controlling trace metal partitioning in a contaminated estuary: *Marine Chemistry*, v. 88, p. 179-192.
- Tusseau-Vuillemin, M. H., Gilbin, R., Bakkaus, E., Garric, J., 2004, Performance of diffusion gradient in thin films to evaluate the toxic fraction of copper to *Daphnia Magna*: *Environ Toxicol Chem*, v. 23, p. 2154-2161.
- Uher, E., Zhang, H., Santos, S., Tusseau-Vuillemin, M. H., Gourlay-France, C., 2012, Impact of Biofouling on Diffusive Gradient in Thin Film Measurements in Water: *Anal Chem*, v. 84, p. 3111-3118.
- Unsworth, E.R., Warnken, K.W., Zhang, H., Davison, W., Black, F., Buffle, J., Cao, J., Clevin, R., Galceran, J., Gunkel, P., Kalis, E., Kistler, D., Van Leeuwen, H.P., Martin, M., Noel, S., Nur, Y., Odzak, N., Puy, J., Van Riemsdijk, W., Sigg, L., Temminghoff, E., Tercier-Waeber, M.L., Toepferwien, S., Town, R.M., Weng, L.P., Xue, H.B., 2006. Model predictions of metal speciation in freshwaters compared to measurements by in situ techniques. *Environ. Sci. Technol.* 40, 1942-1949.
- Vachet, R. W., Callaway, M. B., 2003, Characterization of Cu(II)-binding ligands from Chesapeake Bay using high-performance size-exclusion chromatography and mass spectrometry: *Marine Chemistry*, v. 82, p. 31-45.
- van den Berg, C. M. G., 1982, Determination of copper complexation with natural organic ligands in seawater by equilibration with MnO₂. I. Theory: *Marine Chemistry*, v. 11, p. 307-322.
- van den Berg, C. M. G., 1985, Determination of the zinc complexing capacity in seawater by cathodic stripping voltammetry of zinc-APDC complex ions: *Marine Chemistry*, v. 15, p. 1-18.
- van den Berg, C. M. G., Merks, A. G., and Duursma, E., 1987, Organic complexation and its control on the dissolved concentrations of copper and zinc in the Sheldt estuary: *Estuarine, Coastal and Shelf Science*, v. 24, p. 785-797.
- van den Berg, C. M. G., 1988, Adsorptive cathodic stripping voltammetry and chronopotentiometry of trace metals in sea water: *Anal. Proc.*, v. 25, p. 265-266.
- van den Berg, C. M. G., 1989, Adsorptive cathodic stripping voltammetry of trace elements in sea water: *Analyst*, v. 114, no. 12, p. 1527-1530.
- van der Veeken, P. L. R., Pinheiro, J. P., Van Leeuwen, H. P., 2008, Metal speciation by DGT/DET in colloidal complex systems: *Environ Sci Technol*, v. 42, p. 8835-8840.
- van Hullebusch, E. D., Zandvoort, M. H., Lens, P. N. L., 2003, Metal immobilisation by biofilms: mechanisms and analytical tools: *Rev Environ Sci Biotechnol*, v. 2, p. 9.

7. References

- van Leeuwen, H.P., Town, R.M., Buffle, J., Cleven, R., Davison, W., Puy, J., Van Riemsdijk, W., Sigg, L., 2005, Dynamic speciation analysis and bioavailability of metals in aquatic systems, *Environ. Sci. Technol.*, v. 39, p. 8545–8556.
- van Leeuwen, H.P., Town, R.M., Buffle, J., 2007, Impact of ligand protonation on Eigen-type metal complexation kinetics in aqueous systems. *J. Phys. Chem.*, v. 111, p. 2115–2121.
- Vasyukova, E., Pokrovsky, O. S., Viers, J., Dupré, B., 2012, New operational method of testing colloid complexation with metals in natural waters: *Applied Geochemistry*, v. 27, no. 6, p. 1226-1237.
- Vega, M., and Van den Berg, C. M. G., 1997, Determination of cobalt in seawater by catalytic adsorptive cathodic stripping voltammetry: *Anal Chem*, v. 69, p. 874-881.
- Veyssy, E., Etcheber, H., Lin, R.G., Buat-Menard, P., Maneux, E., 1998, Seasonal variation and origin of particulate organic carbon in the lower Garonne river at La Reole (southwestern France), *Hydrobiologia*, v. 391, p. 113–126.
- Vlahos, P., Chen, R. F., Repeta, D. J., 2002, Dissolved organic carbon in the Mid-Atlantic Bight: *Deep Sea Research II*, v. 49, p. 4369-4385.
- Voelker, B.M., Kogut, M.B., 2001, Interpretation of metal speciation data in coastal waters: the effects of humic substances on copper binding as a test case, *Marine Chemistry*, v. 74, p. 303–318
- Vukosav, P., Mlakar, M., Cukrov, N., Kwokal, Z., Pižeta, I., Pavlus, N., Špoljarić, I., Vurnek, M., Brozinčević, A., Omanović, D., 2014, Heavy metal contents in water, sediment and fish in a karst aquatic ecosystem of the Plitvice Lakes National Park (Croatia), *Environ. Sci. Pollut. Res.*, v. 21, p. 3826–3839.
- Waeles, M., Riso, R.D., Maguer, J.F., Le Corre, P., 2004, Distribution and chemical speciation of dissolved cadmium and copper in the Loire estuary and North Biscay continental shelf, France, *Estuarine Coastal and Shelf Science*, v. 59, p. 49–57.
- Waeles, M., Riso, R.D., Le Corre, P., 2005, Seasonal variations of cadmium speciation in the Penze estuary, NW France, *Estuarine Coastal and Shelf Science*, v. 65, p. 143–152.
- Waeles, M., Riso, R., Le Corre, P., 2007, Distribution and seasonal changes of lead in an estuarine system affected by agricultural practices: The Penzé estuary, NW France: *Estuarine, Coastal and Shelf Science*, v. 74, p. 570-578
- Waeles, M., Tanguy, V., Lespes, G., Riso, R. D., 2008, Behaviour of colloidal trace metals (Cu, Pb and Cd) in estuarine waters: an approach using frontal ultrafiltration (UF) and stripping chronopotentiometric methods (SCP): *Estuarine, Coastal and Shelf Science*, v. 80, p. 538-544.
- Waeles, M., Riso, R.D., Maguer, J.F., Guillaud, J.F., Le Corre, P., 2008a, On the distribution of dissolved lead in the Loire estuary and the North Biscay continental shelf, France. *J. Mar. Syst.*, v. 72, p. 358–365.
- Waeles, M., Riso, R. D., Cabon, J. Y., Maguer, J. F., L'Helguen, S., 2009, Speciation of dissolved copper and cadmium in the Loire estuary and over the North Biscay continental shelf in spring: *Estuarine, Coastal and Shelf Science*, v. 84, p. 139-146.
- Wagner, K., 2004, The use of diffusive gradients in thin films (DGT) for monitoring U and other trace metals in freshwater creeks potentially impacted by mining activities: Charles Darwin University.
- Wallner-Kersanach, M., de Andrade, C. F. F., Zhang, H., Milani, M. R., Niencheski, L. F. H., 2009, In situ measurement of trace metals in estuarine waters of Patos Lagoon using diffusive gradients in thin films (DGT): *J. Braz. Chem. Soc.*, v. 20.
- Wang, J., 1989, Voltammetry after nonelectrolytic preconcentration, in Bard, A. J., ed., *Electroanalytical chemistry*, Volume 16th: New York, Marcel Dekker.

- Wang, R., Chakrabarti, C.L., 2008, Copper speciation by competing ligand exchange method using differential pulse anodic stripping voltammetry with ethylenediaminetetraacetic acid (EDTA) as competing ligand, *Anal. Chim. Acta*, v. 5, p. 153-160
- Warnken, J., Dunn, R.J.K., Teasdale, P.R., 2004, Investigation of recreational boats as a source of copper at anchorage sites using time-integrated diffusive gradients in thin film and sediment measurements. *Mar Pollut Bull.*, v. 49, p. 833-843.
- Warnken, K. W., Zhang, H., Davison, W., 2005, Trace metal measurements in low ionic strength synthetic solutions by diffusive gradients in thin films: *Anal Chem*, v. 77, p. 5440-5446.
- Warnken, K. W., Zhang, H., Davison, W., 2006, Accuracy of the diffusive gradients in thin-films technique: Diffusive boundary layer and effective sampling area considerations: *Anal Chem*, v. 78, p. 3780-3787.
- Warnken, K.W., Davison, W., Zhang, H., 2008. Interpretation of in situ speciation measurements of inorganic and organically complexed trace metals in freshwater by DGT. *Environ. Sci. Technol.* 42, 6903-6909.
- Webb, A. W., Keough, M. J., 2002, Quantification of copper doses to settlement plates in the field using diffusive gradients in thin films: *Sci Total Environ*, v. 298, p. 207.
- Wells, M., Kozelka, P. B., Bruland, K. W., 1998, The complexation of “dissolved” Cu, Zn, Cd, and Pb by soluble and colloidal organic matter in Narragansett Bay, RI.: *Marine Chemistry*, v. 62, p. 203-217.
- Wells, M. L., 2002, Marine colloids and trace metals, in Hansell, D. A., and Carlson, C. A., eds., *Biogeochemistry of Marine Dissolved Organic Matter*: San Diego, Academic Press.
- Wen, L., Shiller, A., Santschi, P. H., Gill, G., 1999, Trace element behavior in Gulf of Mexico estuaries, in Bianchi, T. S., Pennock, J. R., and Twilley, R. R., eds., *Biogeochemistry of Gulf of Mexico estuaries*: New York, John Wiley, p. 303-346.
- Whitby, H, van den Berg, C.M.G., 2015, Evidence for copper-binding humic substances in seawater, *Marine Chemistry*, v. 173, p. 282-290.
- WHO, 1998, *Environmental Health Criteria*, N°200: Copper, p. 1-360.
- Willard, H. H., Merritt, L. L. J., Dean, J. A., Settle, F. A. J., 1988, *Instrumental methods of analysis*, Belmont, CA, Wadsworth Publishing.
- Winderlund, A., Davison, W., 2007, Size and density distribution of sulphide producing microniches in lake sediments: *Environ Sci Technol*, v. 41, p. 8044-8049.
- Windom, H., Wallace, G., Smith, R., Dudek, N., Maedea, M., Dulmage, R., Storti, F., 1983, Behavior of copper in southeastern United States estuaries.: *Marine Chemistry*, v. 12, p. 183-193.
- Wiramanaden, C.I.E., Cullen, J.T., Ross, A.R.S., Orians, K.J., 2008, Cyanobacterial copper-binding ligands isolated from artificial seawater cultures, *Marine Chemistry*, v. 110, p. 28-41
- Wu, J., Jin, M., 2009, Competitive ligand exchange voltammetric determination of iron organic complexation in seawater in two-ligand case: examination of accuracy using computer simulation and elimination of artifacts using iterative non-linear multiple regression, *Marine Chemistry*, v. 114, p. 1-10.
- Ytreberg E, Karlsson J, Ndungu K, Hassellöv M, Breitbarth E, Eklund B., 2011, Influence of salinity and organic matter on the toxicity of Cu to a brackish water and marine clone of the red macroalga *Ceramium tenuicorne*, *Ecotoxicol. Environ. Saf.*, v. 74, p.636-42.
- Zhang, H., Davison, W., 1995, Performance characteristics of diffusion gradients in thin films for the in situ measurement of trace metals in aqueous solution: *Anal Chem*, v. 67, p. 3391-3400.

7. References

- Zhang, H., Davison, W., Gadi, R., and Kobayashi, T., 1998, In situ measurement of dissolved phosphorus in natural waters using DGT: *Anal. Chim. Acta*, v. 67, p. 29-38.
- Zhang, H., Davison, W., 1999, Diffusional characteristics of hydrogels used in DGT and DET techniques: *Analytica Chimica Acta*, v. 398, no. 2–3, p. 329-340.
- Zhang, H., Davison, W., 2000, Direct in situ measurements of labile inorganic and organically bound metal species in synthetic solutions and natural waters using diffusive gradients in thin films: *Anal Chem*, v. 72, p. 4447-4457.
- Zhang, H., Davison, W., 2001, In situ speciation measurements. Using diffusive gradients in thin films (DGT) to determine inorganically and organically complexed metals, *Pure Appl. Chem*, v. 73, p 9-15.
- Zhang, H., Zhao, F. J., Sun, B., Davison, W., and McGrath, S. P., 2001, A new method to measure effective soil solution concentration predicts copper availability: *Environ Sci Technol*, v. 35, p. 2602-2607.
- Zhang, H., 2004. In-situ speciation of Ni and Zn in freshwaters: Comparison between DGT measurements and speciation models. *Environ. Sci. Technol.* 38, 1421-1427.
- Zwolsman, J. J. G., Van Eck, B. T. M., Van Der Weijden, C. H., 1997, Geochemistry of dissolved trace metals (cadmium, copper, zinc) in the Scheldt estuary, southwestern Netherlands: Impact of seasonal variability: *Geochim. Cosmochim. Acta*, v. 61, p. 1635-1652.
- Žutić, V., Legović, T., 1987, A film of organic-matter at the fresh-water sea-water interface of an estuary, *Nature* v. 328, p. 612–614.

8. Curriculum Vitae and list of publications

8. Curriculum Vitae and list of publications

Personal information: Ana-Marija Cindrić, 1983, Zagreb, Croatia,

e-mail: ana-marija.cindric@irb.hr

MZOS ID number of scientist: 315421

CROSB I Url: <http://bib.irb.hr/lista-radova?autor=315421>

Education

2006 – MSc in Chemical engineering and technology

Work experience

2009 – PhD student, Ruđer Bošković Institute

2007 – 2009 – Research analyst, Pliva Hrvatska d.o.o.

Research interest

Studying the chemical speciation, distribution, dynamic and fate of trace elements in aquatic environments (river, estuary, sea)

Collaborator on research projects

2015 – 2019 “*New methodological approach to biogeochemical studies of trace metal speciation in coastal aquatic ecosystems*”, HRZZ project (PI: Dario Omanović)

2013 – 2015 “*Determination of trace metal speciation in coastal waters: towards developing new criteria for water quality control and risk assessment*”, Bilateral project with College of Chemistry and Chemical Engineering, Ocean University of China, Qingdao (PI: Ivanka Pižeta)

2011 – 2012 “*An impact of antifouling paints as a source of contamination by ecotoxic metals in the coastal marine environment*”, COGITO, FRA-CRO, (PI: C. Garnier and D. Omanović)

2010 – 2012 “*Gold microwire: a new tool for trace metal speciation in natural waters*”, The Royal Society, (PI: P.Salaun and D. Omanović)

2007 – 2014 “*Interactions of trace metal species in an aquatic environment*”, MZOŠ (PI: Ivanka Pižeta)

8. Curriculum Vitae and list of publications

Trainings

- 2014: Scholarship of French embassy and Ruđer Bošković Institute; Laboratory PROTEE, Université de Toulon, La Garde, Francuska (22. September-17. October)
- 2013: Scholarship of French embassy and Ruđer Bošković Institute; Laboratory PROTEE, Université de Toulon, La Garde, Francuska (14. October-21. November)
- 2012: Scholarship of French embassy and Ruđer Bošković Institute; Laboratory PROTEE, Université de Toulon, La Garde, Francuska (09. October-14. November)
- 2011: Scholarship of French embassy and Ruđer Bošković Institute; Laboratory PROTEE, Université de Toulon, La Garde, Francuska (26. September-25. October)
- 2011: Scholarship for Short Term Scientific Mission (STSM): „Colloidal trace metal distribution and speciation in estuary waters“ within Cost Action ES0801 program, Université de Bretagne Occidentale, Institut Universitaire Européen de la Mer, Plozane, Brest, France (7. November - 16. December)
- 2010: Scholarship CEEPUS for international school: “Monitoring, Fate and toxicity of toxic compounds in the terrestrial environment” and EMEC 11 – The 11th European meeting on environmental chemistry, Slovenia (29. November-08. December)
- 2010: Scholarship for Research test cruise (Texel, Netherland – Scrabster, Scotland) Cost Action ES0801 ‘The ocean chemistry of bioactive trace metals and paleoclimate proxies’ within: ‘GEOTRACES, Global Change and Microbial Oceanography in the West Atlantic Ocean’ NIOZ, Texel, The Netherlands (19. April - 28. April)

Peer-review publications

1. **Cindrić, Ana-Marija**; Garnier, Cedric; Oursel, Benjamin; Pižeta, Ivanka; Omanović, Dario *Evidencing the natural and anthropogenic processes controlling trace metals dynamic in a highly stratified estuary: The Krka River estuary (Adriatic, Croatia)*. Marine Pollution Bulletin. 94 (2015) 199-216.
2. Strižak, Željka; Ivanković, Dušica; Pröfrock, Daniel; Helmholz, Heike; **Cindrić, Ana-Marija**; Erk, Marijana; Prange, Andreas. *Characterization of the cytosolic distribution of priority pollutant metals and metalloids in the digestive gland cytosol of marine mussels: seasonal and spatial variability*. Science of the total environment. 470/471 (2014) 159-170.

Conference Activities

Chairman of the section C3, Biogeochemistry, *Estuaries status*, section on CIESM, Marseilles, 2013.

Conference proceedings

Cindrić, A-M.; Garnier, C.; Oursel, B.; Pižeta, I.; Omanović, D.; *Natural and anthropogenic processes controlling trace metals dynamics in a highly stratified estuary: the Krka River estuary (Adriatic, Croatia)* 13th International Estuarine Biogeochemistry Symposium, Bordeaux, France, 2015.

Cindrić, A-M.; Garnier, C.; Oursel, B.; Cukrov, N.; Pižeta, I.; Omanović, D.; *Speciation of trace metals in the Krka River estuary (Croatia) determined by complementary techniques*, ENVI-MED COMECOM, Aix/Toulon, France, 2014.

Cindrić, A-M.; *Elektrokemijsko određivanje metala u tragovima u prirodnim vodama: osjetljivost, preciznost i točnost*, ISE, Zagreb, 2014.

Cindrić, A-M.; Garnier, C.; Oursel, B.; Dang, D. H.; Cukrov, N.; Pižeta, I.; Omanović, D.; *Distribution of trace metals in the stratified Krka River estuary (Croatia)*, Rapp. Comm. int. Mer Médit., 40, Axel Romaña (Biogéochimie marine). Monaco: CIESM, 2013. 286-286.

Omanović, D.; **Cindrić, A-M.**; Garnier, C.; Oursel, B.; Salaün, P.; Cukrov, N.; Pižeta, I.; *Application of DGT technique in speciation of trace metals in a stratified estuary // Rapp. Comm. int. Mer Médit., 40, Axel Romaña (Biogéochimie marine), Monaco: CIESM, 2013. 292-292*

Cindrić, A-M.; Garnier, C.; Oursel, B.; Salaun, P.; Pižeta, I.; Omanović, D.; *Distribution and speciation of trace metals in the Krka River estuary (Croatia) accessed by DGT and voltammetry // Conference on DGT and the Environment : abstracts*, Belzunce, M.J. ; Jolley, D. ; Luo, J. ; McLaughlin, M. ; Zhang, Hao. Lancaster, 2013. 17.

Cindrić, A-M.; *Elektrokemijsko određivanje metala u tragovima u prirodnim vodama: osjetljivost, preciznost i točnost*, Zbornik sažetaka 4. Dana Elektrokemije / Komorsky-Lovrić, Šebojka ; Vukosav, Petra ; Jadreško, Dijana. Zagreb, 2013. 8.

Blatarić, A-M.; *Elektroanalitika tragova metala u prirodnim vodama*, 3. dan Elektrokemije, Sjećanje na Marka Branicu, dr. sc. Šebojka Komorsky Lovrić ; dr. sc. Vlado Cuculić ; dr. sc. Ivana Novak ; Dijana Jadreško, dipl. ing. Zagreb, 2012. 4-5.

Blatarić, A-M., Oursel, B., Garnier, C., Pižeta, I., Omanović, D. *Speciation and distribution of trace metals in Krka river estuary (Croatia)*, COST-GEOTRACES Voltammetry Workshop, Šibenik, 2012.

Garnier, C; Tessier, E; Oursel, B; **Blatarić, A-M**, Dang, D.H. *Transfer and speciation of trace metals in coastal environments: analytical and modeling approaches*, 6^{èmes} Journées franco-italiennes de chimie Marseille, 2012.

Blatarić, A-M; *Vertikalna distribucija metala u tragovima u estuariju rijeke Krke određivana pasivnim uzorkivačima i voltametrijom otapanja*, ISE Satellite Student Regional Symposium on Electrochemistry - Ruđer Bošković Institute, Zagreb 2011.

8. Curriculum Vitae and list of publications

- Blatarić, A-M**; Omanović, D; Garnier, C; Lenoble, V; Cukrov, N; Mounier, S; Gonzalez, J-L; Pižeta, I. *Vertical distribution of trace metals in the Krka river estuary (Croatia) accessed DGT and voltammetry*, Book of abstracts, EMEC 11, 2010, 110.
- Cukrov, N; **Blatarić, A-M**; Cuculić, V; Garnier, C; Jalžić, B; Omanović, D. *A preliminary study of trace metals and physic-chemical parameters in water column of anchialine cave Orljak, Croatia*, Rapp. Comm. int. Mer. Medit, CIESM 2010, 238.
- Garnier, C.; Omanović, D.; **Blatarić, A-M.**; Zhao, H.; Lenoble, V.; Durrieu, G.; Cukrov, N.; Pižeta, I.; Mounier, S.; *Dissolved organic matter influence on copper speciation in the stratified oligotrophic Krka river estuary (Croatia): usefulness of voltammetry and 3-D fluorescence spectroscopy analysis*, 2010.
- Garnier, C; Omanović, D; **Blatarić, A-M**; Zhao, H; Lenoble, V; Cukrov, N; Gonzalez, J-L; Pižeta, I. *Trace metal dynamics in the stratified Krka river estuary (Croatia): An integrated approach by voltammetry, DGT and fluorescence spectroscopy*, Rapp. Comm. int. Mer. Medit, CIESM 2010, 253.
- Blatarić, A-M.**, Garnier, C., Omanović, D., Lenoble, V., Cukrov, N., Mounier, S., Gonzalez, J-L., Pižeta, I. *A preliminary study of a DGT-labile trace metals distribution in the stratified Krka River estuary (Croatia)*, TraceSpec 2009, Book of abstracts, Hoffman, Thorsten (ur.). Mainz: University of Mainz, 2009, 81.
- Garnier, C., Omanović, D., **Blatarić, A-M.**, Lenoble, V., Cukrov, N., Mounier, S., Gonzalez, J-L., Pižeta, I. *Multi-techniques study of the trace metal dynamic in the stratified Krka River estuary (Croatia): combination of DGT and voltammetry*, Book of Abstracts. Limoges, 2009, 15.

Scientometrics (Scopus): No of SCI papers: 2; No of citations: 2; H-index: 1