

# Impact of balanced cantilever construction on cast-in-place posttensioned concrete bridges

---

Jurišić, Marino

Doctoral thesis / Doktorski rad

2024

*Degree Grantor / Ustanova koja je dodijelila akademski / stručni stupanj:*

**University of Split, Faculty of Civil Engineering, Architecture and Geodesy / Sveučilište u Splitu, Fakultet građevinarstva, arhitekture i geodezije**

<https://doi.org/10.31534/DocT.058.JurM>

*Permanent link / Trajna poveznica:* <https://um.nsk.hr/um:nbn:hr:123:265011>

*Rights / Prava:* [In copyright](#)/[Zaštićeno autorskim pravom.](#)

*Download date / Datum preuzimanja:* **2025-03-26**



*Repository / Repozitorij:*

[FCEAG Repository - Repository of the Faculty of Civil Engineering, Architecture and Geodesy, University of Split](#)



UNIVERSITY OF SPLIT

dabar

DIGITALNI AKADEMSKI ARHIVI I REPOZITORIJI



**UNIVERSITY OF SPLIT**

**FACULTY OF CIVIL ENGINEERING,  
ARCHITECTURE AND GEODESY**

**Marino Jurišić, mag.ing.aedif.**

**IMPACT OF BALANCED CANTILEVER  
CONSTRUCTION ON CAST-IN-PLACE POST-  
TENSIONED CONCRETE BRIDGES**

**Doctoral Dissertation**

**Split, 2024.**

Marino Jurišić, mag.ing.aedif.

Number: 058

**This doctoral dissertation has been submitted for evaluation to the University of Split, Faculty of Civil Engineering, Architecture and Geodesy, for the purpose of obtaining the doctoral academic degree in Technical Sciences, field of Civil Engineering**

**Supervisor (mentor):** Alen Harapin, PhD, prof.

**Additional Supervisor (co-mentor):** Dragan Čubela, PhD, assoc. prof.

**Committee for the assessment of doctoral dissertation:**

Nikola Grgić, PhD, assoc. prof.

Mladen Glibić, PhD, prof.

Đani Rahimić, PhD, assoc. prof.

**Committee for the doctoral dissertation defense:**

Nikola Grgić, PhD, assoc. prof. \_\_\_\_\_

Mladen Glibić, PhD, prof. \_\_\_\_\_

Đani Rahimić, PhD, assoc. prof. \_\_\_\_\_

The dissertation has been defended on the 19<sup>th</sup> of July, 2024.

Secretary:

Saša Delić, dipl. iur.

**The dissertation contains:**

77 pages of text

82 figures

3 tables

57 references

**This work would not have been possible without the selfless help of many individuals who directly or indirectly contributed to this dissertation. Although my name appears on the cover, this is truly a collaborative effort, and I am deeply grateful for all the support I have received.**

**I extend my heartfelt thanks to Hering and its entire team—especially Ladislav Bevanda, Mario Jurišić, Mario Bevanda, and Marin Nikolić—for granting me access to construction sites and providing invaluable assistance at every stage, including the preparations for the experiment. Special thanks to Marko Bošnjak and Toni Đotlo for their immense help before and during the experiments on the construction sites.**

**I am also grateful to the Faculty of Civil Engineering, Architecture and Geodesy, University of Split, for lending the instruments used in the experiments. Without these instruments, none of this work would have been possible. Special thanks to Alen Harapin and Nikola Grgić for their prompt and no-questions-asked response to my plea.**

**I am grateful to all my colleagues, especially Mladen Glibić, Željko Mikulić, Mladen Kustura, Dragan Ćubela and Boris Čutura, who supported me with (mostly) good advice, and an abundance of laughter.**

**A special thank you to my mentor, Alen Harapin, for his invaluable advice, patience, positivity, friendship and thorough proofreading. His guidance and support have been instrumental in shaping this dissertation.**

**I thank my parents, Antonija and Mario, and my sister, Mia, for their unwavering support and guidance before, during, and after my studies. Their encouragement has been invaluable.**

**Special thanks to my father, Mario, for instilling in me a love for civil engineering and bridges. He introduced me to construction sites from a young age and has provided immeasurable support throughout my life. His passion for the field made my work enjoyable, and I owe much of my success to him. He is the reason I consider my work fun and love doing what I do. In a way, this dissertation belongs to him as well.**

**Finally, I am deeply grateful to my wife, Matea, and my daughters, Antonija and Valerija. They have selflessly sacrificed their time, allowing me to devote mine to this work. Their unwavering support and understanding never faltered, and I am endlessly grateful to have such an incredible family by my side. All my work is dedicated to them.**

**“Still round the corner there may wait  
A new road or a secret gate,  
And though we pass them by today,  
Tomorrow we may come this way  
And take the hidden paths that run  
Towards the Moon or to the Sun.”**

**— J.R.R. Tolkien**

Marino Jurišić, mag.ing.aedif.

## **Impact of balanced cantilever construction on cast-in-place post-tensioned concrete bridges**

### **Abstract:**

In this dissertation the impact of balanced cantilever bridge construction method on the deformations and stresses of prestressed concrete bridges built on site is investigated. The specific scientific contribution of the dissertation is the preparation and execution of measurements on bridges, carried out on site and on real structures during stage construction, which are rare in the world. The measurements were carried out on the Vranduk 1 and Vranduk 2 bridges, located on the Vc corridor, on the base segments above the piers, and all phases of the balanced cantilever construction were monitored, from the first segment to the final connection of the bridges.

Apart from the execution of measurements on bridges during construction, numerical simulations based on measured results can also be considered as a valuable scientific contribution of this dissertation. In these simulations, the deformations and stresses in different cross section points measured during construction were compared with the results obtained by numerical analysis on a complex spatial model. Very good matching between measured and numerical results, as well as observed deviations which were commented and explained, confirmed the basic assumption that a good material model of the building that includes the so-called long-term effects in concrete and steel, can accurately simulate the real state of the structure.

Long-term effects in concrete and steel, as well as temperature taken during construction stages, are incorporated into the model, and compared to data obtained on completed bridges, provide a better match with real behaviour, which can also be considered a valuable scientific contribution. Also, the results of experimental and numerical research presented in this doctoral thesis provide valuable data, which can be used in the creation of new numerical models and the refinement of existing ones.



Finally, the presented results and conclusions offer practical guidelines for designers, contractors and project managers involved in balanced cantilever bridge construction, as well as valuable knowledge for optimizing construction methods and increasing the safety and efficiency of bridge projects.

**Keywords:** balanced cantilever method, prestressed concrete, concrete bridges, strain, stress, monitoring, numerical model, creep, shrinkage

Marino Jurišić, mag.ing.aedif.

## **Utjecaj slobodnog konzolnog načina gradnje betonskih grednih mostova na njihovo ponašanje i sigurnost**

### **Sažetak:**

U ovoj disertaciji istražuje se utjecaj slobodno konzolne izgradnje na deformacije i naprezanja u prednapregnutim betonskim mostovima građenim na licu mjesta. Specifični znanstveni doprinos disertacije je priprema i provođenje mjerenja na mostovima, izvedenih na licu mjesta i na stvarnim konstrukcijama tijekom fazne izgradnje, što je rijetkost u svijetu. Mjerenja su provedena na mostovima Vranduk 1 i Vranduk 2, smještenim na koridoru Vc, na baznim segmentima iznad stupova, te su praćene sve faze konzolne izgradnje, od prvog segmenta do konačnog spajanja mostova.

Osim izvođenja mjerenja na mostovima tijekom izgradnje, numeričke simulacije temeljene na izmjerenim rezultatima također se mogu smatrati vrijednim znanstvenim doprinosom ove disertacije. U tim simulacijama, deformacije i naprezanja u različitim točkama poprečnog presjeka izmjerene tijekom izgradnje uspoređeni su s rezultatima numeričke analize na složenom prostornom modelu. Vrlo dobro poklapanje između izmjerenih i numeričkih rezultata, kao i uočena odstupanja koja su komentirana i objašnjena, potvrdili su osnovnu pretpostavku da dobar model materijala građevine koji uključuje takozvane dugoročne efekte u betonu i čeliku, može točno simulirati stvarno stanje konstrukcije.

Dugoročni efekti u betonu i čeliku, kao i temperatura mjerena tijekom faza izgradnje, ugrađeni su u model i u usporedbi sa rezultatima na dovršenim mostovima pružaju bolje podudaranje sa stvarnim ponašanjem, što se također može smatrati vrijednim znanstvenim doprinosom. Također, rezultati eksperimentalnih i numeričkih istraživanja predstavljeni u ovoj doktorskoj disertaciji pružaju vrijedne podatke, koji se mogu koristiti pri stvaranju novih numeričkih modela i dorađivanju postojećih.

Na kraju, predstavljeni rezultati i zaključci nude praktične smjernice za projektante, izvođače i voditelje projekata uključene u izgradnju mostova slobodno konzolnom gradnjom, kao i vrijedno znanje za optimizaciju metoda izgradnje i povećanje sigurnosti i učinkovitosti projekata mostova.

**Ključne riječi:** slobodno konzolna metoda gradnje, prednapeti beton, betonski mostovi, relativne deformacije, naprezanja, monitoring, numerički model, puzanje, skupljanje

## LIST OF APPENDED PAPERS AND MY CONTRIBUTION

The doctoral dissertation is based on four (4) papers (see Appendix), referred by Roman numbers in the text of the dissertation.

No.	Paper and my contributions	JCR Rank*	SJR Rank*
[I]	<p><b>Jurišić M.</b> and Cvitković M.: <i>STUDENČICA BRIDGE TESTING</i>, e-gfOs, no. 12, pp. 1-9, 2016,  <a href="http://dx.doi.org/10.13167/2016.12.1">http://dx.doi.org/10.13167/2016.12.1</a>                      Participation in planning and conducting the testing of the bridge</p>	Q4	Q4
[II]	<p>Harapin A., <b>Jurišić M.</b>, Bebek N. and Sunara M.: <i>Long-Term Effects in Structures: Background and Recent Developments</i>, Appl. Sci. 2024, 14, 2352.  <a href="https://doi.org/10.3390/app14062352">https://doi.org/10.3390/app14062352</a>                      Participation in design of the numerical models for Long-term effects in concrete</p>	Q2	Q2
[III]	<p><b>Jurišić M.</b>, Bebek N., Čubela D. and Harapin A.: <i>Balanced cantilever construction method in post-tensioned concrete bridges</i>, accepted for publication in Structural Engineering International (15.05.2024.)  <a href="https://doi.org/10.1080/10168664.2024.2356559">https://doi.org/10.1080/10168664.2024.2356559</a>                      Participation in study of various ways and technologies of cantilever construction</p>	Q4	Q2
[IV]	<p><b>Jurišić M.</b>, Bebek N., Čubela D. and Harapin A.: <i>Strain Analysis on Cast-In-Place Balanced Cantilever Prestressed Concrete Bridges During Construction</i>, Structural Engineering International, Published online: 02 Feb 2024,  <a href="https://doi.org/10.1080/10168664.2023.2296979">https://doi.org/10.1080/10168664.2023.2296979</a>                      Participation in planning and conducting the testing of the bridges</p>	Q4	Q2

(\*) Quartiles are determined for the year of submission or the paper publication, according to the more favorable classification for the candidate

# CONTENTS

- 1. Introduction..... 1
  - 1.1. History of cantilever construction ..... 3
  - 1.2. Post-tensioned concrete balanced cantilever bridges ..... 13
  - 1.3. Motivation ..... 16
  - 1.4. Previous research on post-tensioned concrete balanced cantilever bridges ..... 19
  - 1.5. Dissertation goal and contents ..... 28
  - 1.6. Methodology..... 30
  - 1.7. Outline of included papers..... 31
  - 1.8. Expected scientific contribution ..... 32
- 2. Experimental research overview ..... 34
  - 2.1. Load tests on bridges preceding the experimental research ..... 34
  - 2.2. Overview of tested bridges ..... 35
  - 2.3. Monitoring plan and measuring equipment installation ..... 39
- 3. Numerical modelling and result comparison ..... 46
  - 3.1. Long-term effects in concrete structures ..... 46
  - 3.2. Software used for numerical modelling..... 47
  - 3.3. Numerical models of the bridges ..... 48
  - 3.4. Result comparison ..... 54
  - 3.5. Discussion..... 66
- 4. Conclusion and directions for further research ..... 68
  - 4.1. Conclusion ..... 68
  - 4.2. Directions for further research..... 69
- 5. Literature..... 70
- 6. List of figures ..... 75

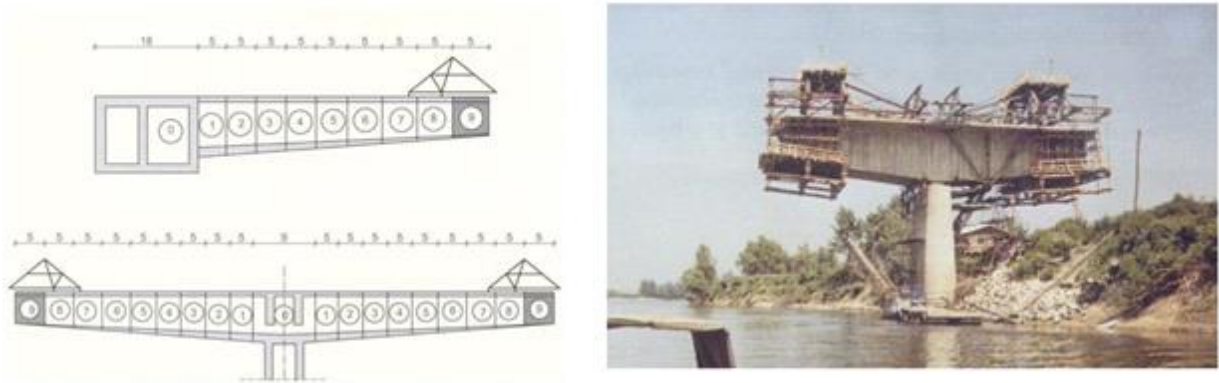
## **1. INTRODUCTION**

With the development of civilization, the demands for number and quality of roads are increasing. Such roads have more demanding route elements, which include larger curve radii and limited longitudinal gradient. This phenomenon is more accentuated when it comes to roads of a higher rank (for example, highways). Due to the demanding elements of the route, the need for a large number of structures, including bridges, arises.

The balanced cantilever construction method represents a sophisticated and dynamic approach to the creation of superstructures, offering a nuanced interplay of engineering principles and construction techniques. As this method has evolved over time, it has transitioned from its initial application in steel bridge construction to becoming a staple in the realm of prestressed concrete bridges, where the variable superstructure height adds an additional layer of complexity and adaptability to the construction process.

The balanced cantilever construction method is very common and very practical in inaccessible and high terrains. The main advantages of the method are that it avoids high and expensive conventional scaffolding and allows relatively large spans which reduce the number of piers. Balanced cantilever construction can be carried out by in-situ concreting or the assembly of prefabricated superstructure segments. The construction technology is such that the foundation and column are made first. After the construction of the column, a base segment (pier head) is made at the top of the column, which is wide enough to start construction. Movable scaffolding is mounted on the base segment, which consists of: main load-bearing frames, floor rails, secondary supports (steel profiles or grids), steel ropes or rods that support the secondary supports, floors and formwork. The front end of the frames rests approx. 0.4-0.5 m from the edge of the concrete, while the rear end of the frames is anchored approx. 4-5 m behind the front support in the concrete of the span construction. After the construction of an individual segment, the movable scaffolding is moved to a new edge of the concrete, where it is secured for the construction of the next segment. This procedure is most often done on both sides so that the column is not burdened with an additional bending moment ("Balanced cantilever method").

Figure 1 shows the construction method of bridges using the cantilever method. The left picture shows the principle of construction, and the right picture shows a real bridge (Figure 1). In the case of prefabricated elements, the shorter length of the segments reduces the total weight of the segment and thus reduces the cost of installation machinery.



*Figure 1.* Classic design of bridges with balanced cantilever construction

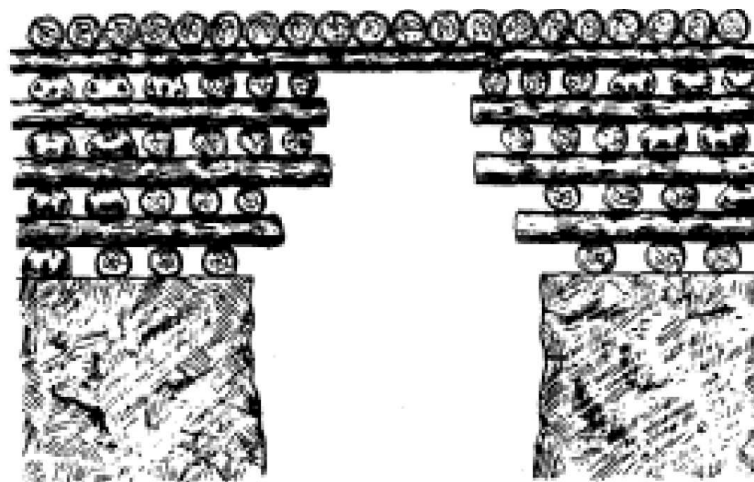
In the realm of prestressed concrete bridges, the balanced cantilever construction method capitalizes on the inherent strength and durability of concrete. The incorporation of prestressing steel cables into the upper slab of the superstructure cross-section is a key innovation. These cables are strategically placed to counteract the forces exerted during the construction phase, ensuring that the bridge can support substantial loads even before its completion. This proactive approach not only enhances the load-bearing capacity but also contributes to the longevity of the structure, aligning with the growing emphasis on sustainable and resilient infrastructure. The utilization of prestressed concrete in conjunction with the balanced cantilever method empowers engineers and construction teams to achieve expansive spans, overcoming geographical challenges and providing efficient solutions for diverse topographies. The segments of the superstructure, whether constructed on-site through meticulous concreting processes or integrated seamlessly with prefabricated segments, showcase the method's adaptability to different project requirements.

Moreover, the balanced cantilever construction method introduces a progressive construction sequence. Each newly completed segment, post-hardening, not only contributes to the structural integrity of the bridge but also serves as a stable foundation for the ongoing construction. This iterative process allows for a continuous and systematic progression, minimizing disruptions and optimizing construction efficiency.

The balanced cantilever construction method has become a cornerstone in contemporary bridge engineering, embodying a fusion of traditional principles with cutting-edge technologies. Its adaptability, sustainability, and capacity for achieving impressive spans make it a favoured choice for engineers tackling the challenges of modern infrastructure projects. As the method continues to evolve, it stands as a testament to the ingenuity and innovation within the realm of civil engineering and construction [1].

### **1.1. History of cantilever construction**

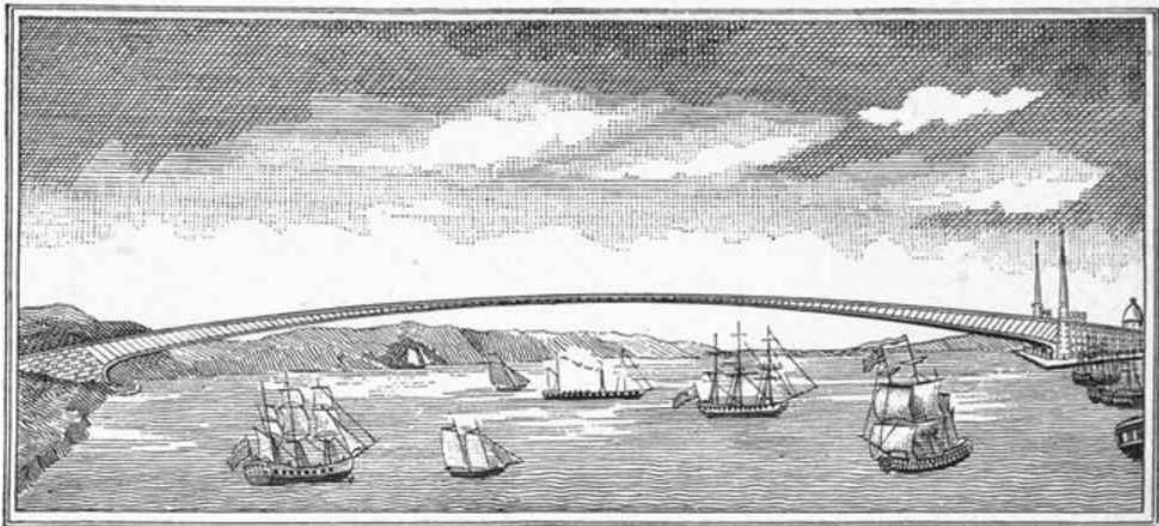
Cantilever construction method has been used in ancient times to build bridges worldwide. The first bridges to be constructed with this method were made with wood. Caesar writes about Gallic works on wooden bridges built by placing timber in orthogonal horizontal rows filled with boulders that acted like counterweight and supported protruding timber beams. Similar structures can still be found in Tibet, China and India (Figure 2) [2].



*Figure 2.* Principle of a Gallic wooden bridge  
(Setra Design guide [2])

American engineer Thomas Pope designed a 550 m span wooden bridge with a shallow arch resting on two masonry abutments from where it was supposed to be built by the cantilever method with prefabricated segments (Figure 3) [1].

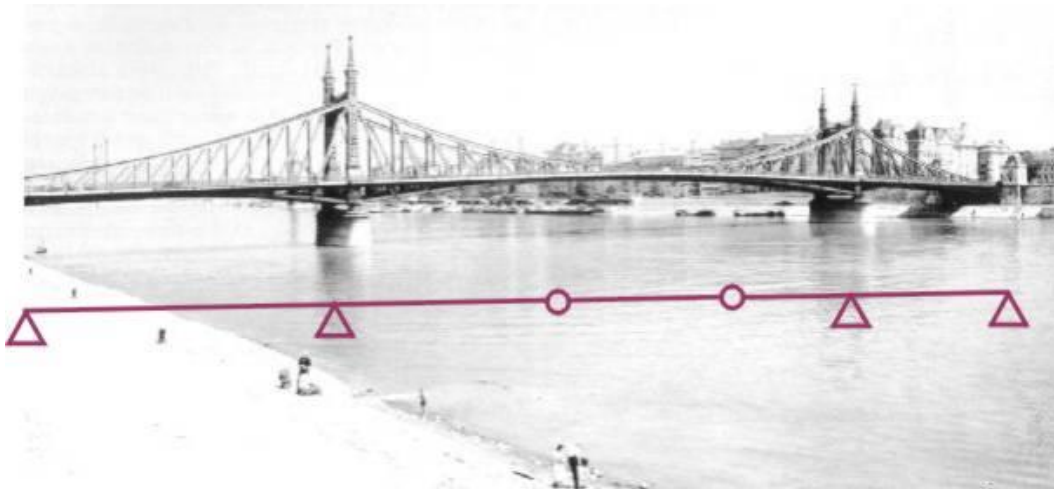




*Figure 3. Thomas Pope – proposed timber bridge*

(Public domain, <https://www.clipart-history.com/picture.php?/7461>)

Engineers from 19th century understood that continuous beams have a better moment distribution due to the negative support moment compared to simple beams, and can be used to achieve greater spans [3]. Heinrich Gerber was one of those who patented a hinge in a span of a continuous girder, and is considered to be the first to build such a structure [4]. The hinge creates a statically determinate system which is not subjected to parasitic effects due to loads like temperature, differential settling and creep and shrinkage (Figure 4). Besides that, the calculation of stresses and forces in the structure is simpler [3].



*Figure 4. Gerber hinge principle*

(Tamas Balogh, Pal Turan, <https://epito.bme.hu/news/20140613/Danube-ship-trip-with-Brazilian-students?language=en>)

Throughout 19th and 20th century the cantilever construction method is mainly used for building arch and truss metal bridges with suspended central span. The Hassfurt Bridge, which was completed in 1867, is considered the first modern cantilever bridge with a main span of 38 m (Figure 5).



*Figure 5. Hassfurt Bridge*

(An Engineer Imagines, Peter Rice, Ellipsis, London, 1993, pp 32, <https://fallowmedia.com/2018/nov/bridge-in-hassfurt/>)

Other important bridges are: The High Bridge in Kentucky completed in 1877, the Niagara Railroad Bridge completed in 1883, the Poughkeepsie Bridge completed in 1889, and the most famous cantilever bridge in Scotland, Forth Bridge, that was completed in 1890 and held the record for the longest span in the world (518.16 m) for 29 years (Figure 6) [5].



Figure 6. Forth bridge, Scotland

(Encyclopædia Britannica, © J4james/Dreamstime.com,  
<https://www.britannica.com/topic/Forth-Bridge>)

One of the designers of Forth bridge, Benjamin Baker, demonstrated the static principle of a bridge with the added central span hanging on the cantilever superstructure (Figure 7). The man sitting in the middle represents the central span. To represent compression forces in bottom chord wooden sticks are used, while the hands represent tensile forces in the upper chord. Weights on the end represent the counterweight abutments holding the added central span.

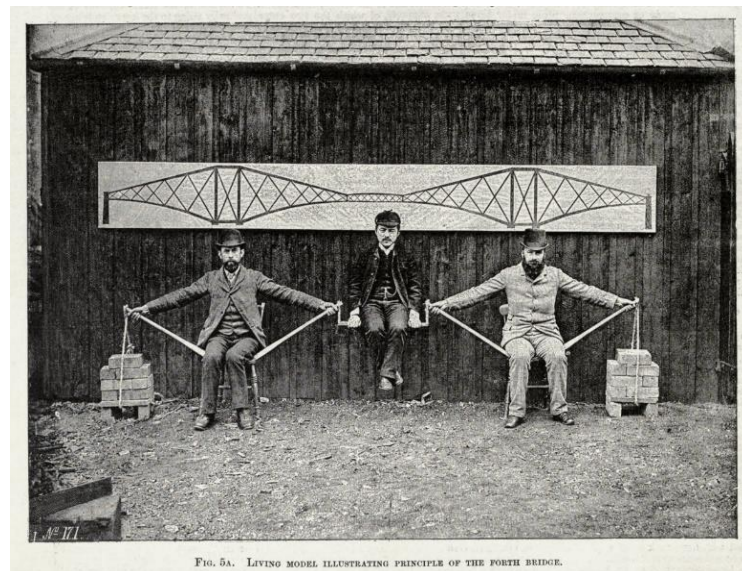


Figure 7. Demonstration of the Forth bridge statical principle

(Public domain,

[https://en.wikipedia.org/wiki/Forth\\_Bridge#/media/File:Cantilever\\_bridge\\_human\\_model.jpg](https://en.wikipedia.org/wiki/Forth_Bridge#/media/File:Cantilever_bridge_human_model.jpg))



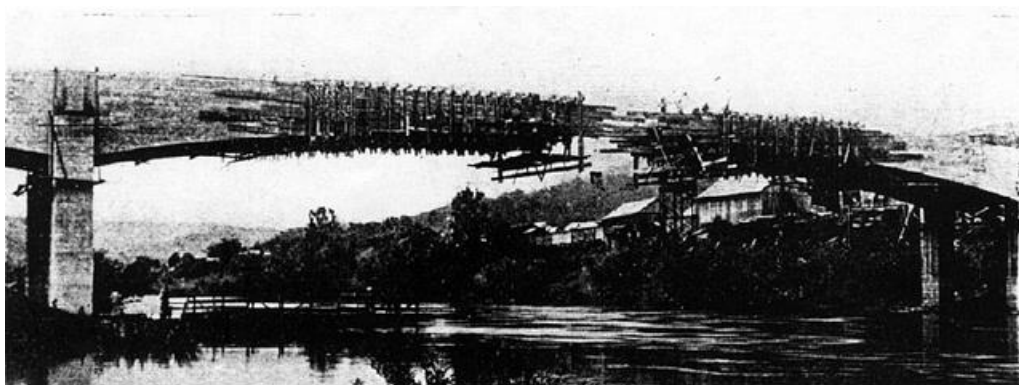
After the development of reinforced concrete, the cantilever method is used for concrete bridges. In 1928, Freyssinet was already working on the construction of the segments of the arches of the Plougastel Bridge with a span of 185 m (Figure 8). These segments had a significant overturning moment (47 000 kNm) due to the heavy weight of the mobile scaffolding during construction. In order to balance this moment, Freyssinet devised a system in which it connects the opposite parts of the two arches with steel cables and thus creates temporary pre-tensioning.



*Figure 8. Plougastel Bridge*

(Public domain, [https://en.wikipedia.org/wiki/Plougastel\\_Bridge#/media/File:Pont-albert-loupe.jpg](https://en.wikipedia.org/wiki/Plougastel_Bridge#/media/File:Pont-albert-loupe.jpg))

In the form in which it exists today, this method was first applied in 1930 on the Herval Bridge over the Rio Peixe River in Brazil, where reinforcing bars were continued with serrated elements (Figure 9).



*Figure 9. Herval Bridge*

(Public domain, <https://picryl.com/media/ponte-herval-1931-3456fd>)

Caquot designed the 100 m span Donzere Bridge in France, but this technique has not been widely adopted on reinforced concrete bridges due to the large amount of reinforcement required to secure the cantilevers and the crack widths in the upper zone of the span structure (Figure 10).



*Figure 10. Donzere Bridge*

(Structurae, Nicolas Janberg, <https://structurae.net/en/structures/donzere-mondragon-canal-bridge>)

After the development of prestressing, which is suitable for cantilever construction, the method receives wide application. Freyssinet used it in 1945-1950. for the construction of the Luzancy Bridge, five bridges over the Marne River and the Caracas Viaduct. The bridges over the Marne had a cantilevered section next to the abutment, while the middle section of the arch was set in place by mast cranes. The Caracas Viaduct is a cantilevered arch bridge where the segments are concreted on a formwork that is suspended from the main columns (Figure 11).



*Figure 11. Caracas Viaduct*

(Veronidae, CC BY-SA 3.0,

[https://www.wikidata.org/wiki/Q109781167#/media/File:Autopista Caracas - La Guaira dicembre 2000\\_029.jpg](https://www.wikidata.org/wiki/Q109781167#/media/File:Autopista_Caracas_-_La_Guaira_dicembre_2000_029.jpg))

In Germany Finsterwalder introduces cantilever construction in 1950 on the Balduinstein and Neckarrens bridges. The contractor company Boussiron used the method for the construction of the la Voulte railway bridge over the Rhône in 1952 (Figure 12).



*Figure 12. La Voulte railway bridge*

(FredSeiller, CC BY-SA 4.0,

[https://fr.wikipedia.org/wiki/Viaduc\\_de\\_la\\_Voulte#/media/Fichier:Viaduc\\_ferroviaire\\_\(La\\_Voulte-sur-Rh%C3%B4ne\).jpg](https://fr.wikipedia.org/wiki/Viaduc_de_la_Voulte#/media/Fichier:Viaduc_ferroviaire_(La_Voulte-sur-Rh%C3%B4ne).jpg))

From this moment on, the development of cantilever construction accelerated. In the period from 1952-1953. in Germany, the company Dyckerhoff and Widman works on structures with prestressed bars. The first bridge in France where the segments are concreted on site is Chazey (Figure 13). It was made in 1955 using prestressing cables. At the same time cable prestressing starts in Germany, Austria and several other countries. Except for arches and span structures with inclined columns, all structures had a joint in the middle of the span.

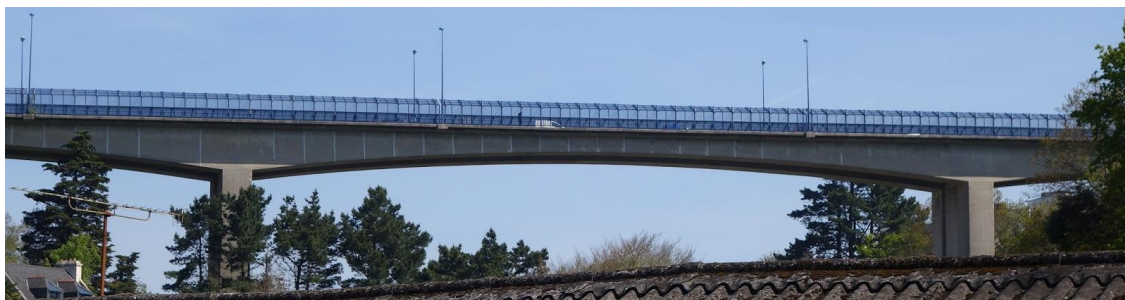




*Figure 13. Chazey bridge*

(Public domain, <https://www.chazey-sur-ain.fr/accueil/actualite/147-inspection-detaillee-du-pont-de-chazey-sur-ain>)

A new step was taken in 1962 when the joint was removed and the continuity of the span construction was introduced on the Lacroix-Falgarde and Vallon du Moulin a Poudre bridges (Figure 14).



*Figure 14. Vallon du Moulin a Poudre Bridge*

(Gombert, Didier du bout du Monde, <https://didierduboutdumonde.blogspot.com/2017/04/le-quartier-de-kerinou-brest.html>)

Another step forward was made with the introduction of prefabricated elements. One of the first bridges with prefabricated elements was Choisy-le-Roi built in 1962 in France where the joints were glued and the segments integrated by prestressing.



*Figure 15. Choisy-le-Roi Bridge*

(Structurae, Jacques Mossot, <https://structurae.net/en/media/4427-seine-river-bridge-at-choisy-le-roi>)

Similar techniques are soon used all over the world and imposing structures such as the Chillon Viaduct and the Rio Niteroi Bridge in Brazil (total length of 8 km) were built. The cantilever construction method was also developed for cable-stayed bridges, for example the Brotonne bridge with a main span of 320 m, which at one time held the record for the longest span made of prestressed concrete [1]. The longest balanced cantilever cast-in-place span is currently the Shibampo Bridge (2006) over the Yangtze River in China with a span of 330 m (Figure 16). It is followed by the Stolma Bridge (1998) in Norway with a span of 301 m.





*Figure 16. Shibampo Bridge*

(Glabb, CC BY-SA 3.0,

[https://upload.wikimedia.org/wikipedia/commons/5/5e/Shibanpo\\_Bridge-1.jpg](https://upload.wikimedia.org/wikipedia/commons/5/5e/Shibanpo_Bridge-1.jpg))

## 1.2. Post-tensioned concrete balanced cantilever bridges

As previously stated, the most usual method of balanced cantilever post-tensioned concrete bridge construction is to first build a column on top of which the initial part of the span construction is built often referred to as the base segment or the pier head. Then, mobile scaffolding called the cantilever forming travellers, which will support the formwork of individual bridge segments, are installed. The main load-bearing part of the moving traveller is a rhombus, which is attached to the upper edge of the span structure with anchors through a steel rail. After the formwork is placed, the segment is reinforced and concreted.

As soon as the concrete reaches sufficient strength, the cables of the cantilever construction in the upper part of the segment are pre-tensioned in order to activate the segment. Then the formwork is released and the traveller is pushed forward over the rails to get into the position for the next segment. This process is repeated until the bridge cantilever is completed. It is important to emphasize that this process with balanced cantilevered bridges takes place simultaneously on the left and right sides of the cantilever, so that the cantilever remains in balance (Figure 17).

In addition to this, there are a number of other ways of construction that are, in principle, a variation of the one described. There are minor differences in the method of formwork placement, which conceptually does not change the method of designing and execution.

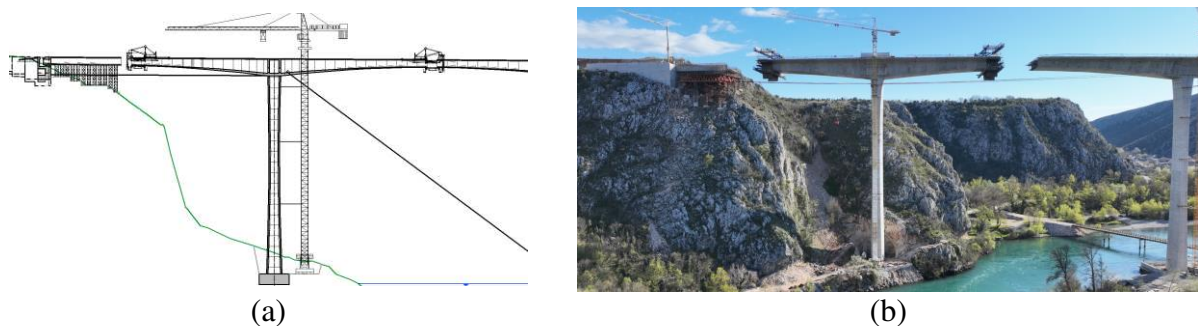


Figure 17. (a) Scheme of a balanced cantilever construction process on a prestressed concrete bridge; (b) Balanced cantilever construction method on a prestressed concrete bridge during construction

The advantages of this type of construction are numerous. First, span structures are made without any contact with the ground, which allows construction over flooded rivers or very deep and steep ravines. This method can also be used to build different geometries. Span structure can be of constant or variable height (linear, parabolic, cubic).

The method is flexible with regard to the geometry of the road on the bridge because, unlike the incremental launching method, any horizontal and vertical geometry can be made without major difficulties. Furthermore, construction in segments of 3-5 m is very feasible in terms of the required amount of formwork for span construction, even if the spans are small and of different lengths (Figure 18) [2].

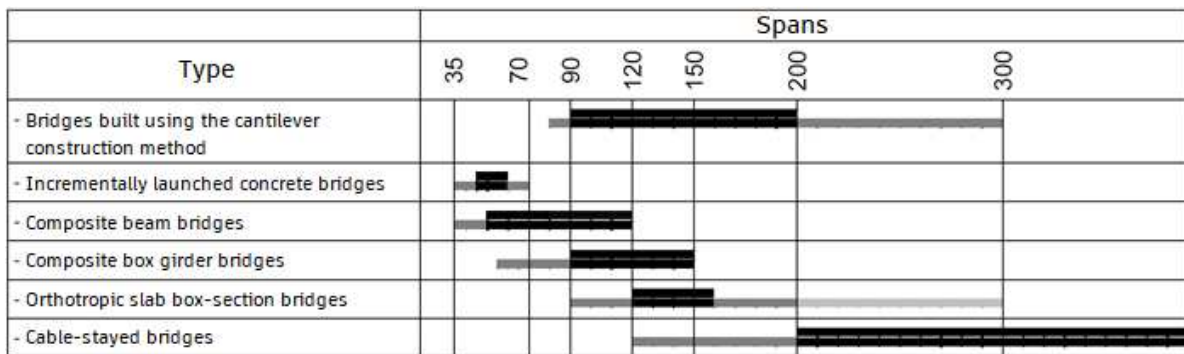


Figure 18. Feasibility of different bridge types by span length (m) – (black – feasible, dark grey – possible and possibly feasible, light grey – possible but not feasible)  
(Setra Design guide [2])

Cantilever prestressed concrete bridges with a box cross section superstructure can be built in spans of 60-300 m. However, there are other cost-effective construction methods in this range. Cantilever prestressed concrete bridges with spans under 80 m compete with concrete-steel composite bridges in all essential aspects. If the geometry of the road is favourable, then they are competing with prestressed incrementally launched bridges that have a span of 35-70 m. For spans between 70-120 m, cantilever bridges can have a constant or variable span structure height. In these spans, they are competing with concrete-steel girder bridges. For aesthetic reasons, cable stayed bridges are also used in these spans. For spans of 100-200 m, cantilever bridges usually have a variable height of the span structure and compete with box section composite bridges and cable-stayed bridges. The design with light steel webs can also prove to be economical [2].

The disadvantage of this method is that for equal spans these bridges are much heavier than composite bridges. In the case of prefabricated elements, the shorter length of the segments reduces the total weight of the segment and thus reduces the cost of installation. However, the bigger weight request larger foundations and supports, and the problem arises when the bridge is built on weak ground or a seismically active area.

Another major drawback is the large number of tasks that must be completed in the field for the construction of the span structure and access roads. Although the number of these tasks is reduced if the segments are prefabricated, it is still higher than the incremental launching process. When the structure crosses the road, safety can be jeopardized which can lead to road closures. From an aesthetic point of view, bridges made with the cantilever construction method often have a high span cross section, which can be a problem on certain construction sites. As a result of segmental construction and segmental concreting, there may be a difference in the colour of the structure in adjacent segments.

### 1.3. Motivation

The strongest motivation for carrying out research on the behaviour of structures built using balanced cantilever method is to prevent possible disasters due to insufficient knowledge of force transfer and load-bearing capacity. Only two examples will be cited that left a deep mark on the bridge-building community.

One of the earlier notable examples of collapse was a steel bridge in Quebec that collapsed twice during construction. The first collapse took place in 1907 with 75 victims. The collapse occurred due to a wrong calculation, i.e. wrong calculation of the dead weight of the bridge, which was greater than the bridge under construction could handle [6]. The bridge continued to be built in 1916, but during the raising of the central part, there was a problem with the cranes which caused the central part to fall and claimed the lives of 13 workers (Figure 19) [7]. The bridge was finally completed in 1919 and still holds the record for the longest span of a cantilever bridge, at 549 m.



*Figure 19.* Quebec bridge, collapse of the central segment

(Public domain,

[https://en.wikipedia.org/wiki/Quebec\\_Bridge#/media/File:Quebec\\_Bridge\\_Collapse.jpg](https://en.wikipedia.org/wiki/Quebec_Bridge#/media/File:Quebec_Bridge_Collapse.jpg))

Another example is the Koror-Babeldaob balanced cantilever prestressed concrete bridge in Palau built in 1977 (Figure 20). It had a main span of 240.8 m and at the time held the record for the longest span of its type. The bridge had a joint in the middle of the span [8]. Shortly after construction, the bridge developed large vertical deflections. By 1996, the middle of the span had dropped by 1.2 m, which upset the local population who asked the authorities to intervene.

Two studies were made (Louis Berger International and Japan International Cooperation Agency) and both concluded that the bridge is safe and that the large displacements are the result of concrete creep and a lower elasticity modulus. A third study was made in 1993 by ABAM, Seattle, which concluded that the bridge would drop an additional 0.84 m in the next 85 years and a rehabilitation with 40 external pre-stressed cables was proposed.



Figure 20. (a) Koror-Babeldaob bridge after construction; (b) Koror-Babeldaob bridge after collapse

(Public domain, [https://upload.wikimedia.org/wikipedia/commons/2/20/Former\\_Koror-Babeldaob\\_Bridge1.jpg](https://upload.wikimedia.org/wikipedia/commons/2/20/Former_Koror-Babeldaob_Bridge1.jpg));

(Ed Zeilnhofer, CC BY 3.0,

[https://en.wikipedia.org/wiki/Koror%E2%80%93Babeldaob\\_Bridge#/media/File:Original\\_Koror-Babeldaob\\_Bridge\\_collapse.png](https://en.wikipedia.org/wiki/Koror%E2%80%93Babeldaob_Bridge#/media/File:Original_Koror-Babeldaob_Bridge_collapse.png))

Renovation was done between 1995 and 1996, during which the joint in the middle of the bridge was removed and external prestressed cables with deviators were installed. Three months after reconstruction on September 26, 1996, the bridge collapsed suddenly and catastrophically, in calm sunny weather and practically unladen. A subsequent study determined that the cause of the collapse was a change in the bridge's static system and a crack in the top slab, where tensile stress occurred. The calculation of the bridge was made using a linear model, not taking into account the redistribution of forces due to the effects of creep and shrinkage (Figure 21) [9-10].

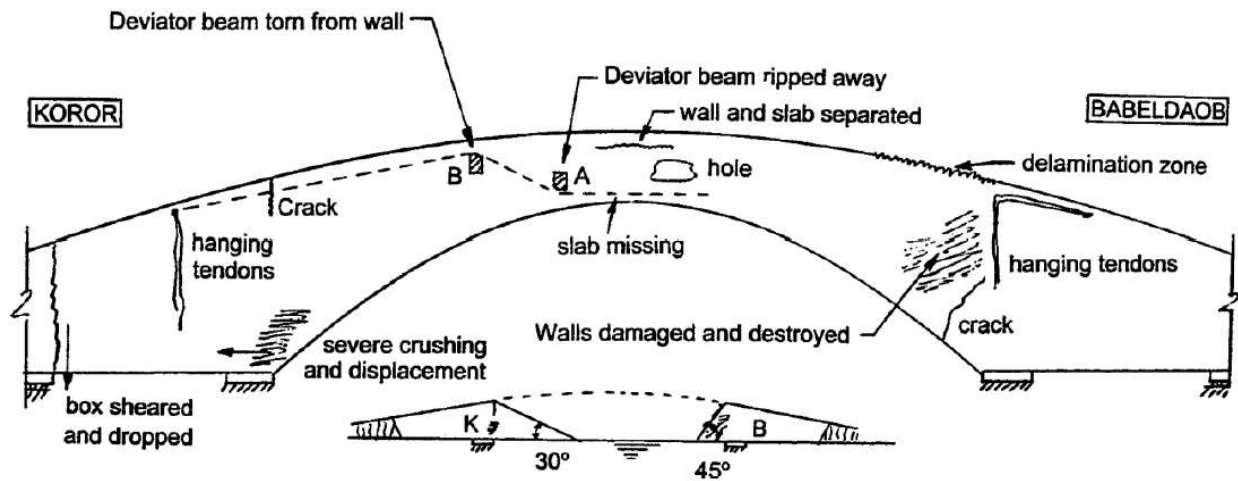


Figure 21. Koror-Babeldaob bridge damage overview

(Matthias Pilz, *The Koror-Babeldaob Bridge in the Republic of Palau, History and Time Dependent Stress and Deflection Analysis*)

As previously described, the balanced cantilever method is, on the one hand, very simple, but at the same time extremely complex regarding the state of stress and deformation, geometry (deflection) and safety of the bridge during its construction and use. Namely, each segment of the bridge has a different age of the concrete, and thus its essential mechanical characteristics over time: strength, modulus of elasticity/stiffness, deformations, displacements, shrinkage, creep and aging of the concrete. They depend on the type of concrete and its composition, but also on the length of the segment production cycle. On the other hand, the losses of force in the post-tensioned cables during and after the construction of the bridge depend on the mechanical characteristics of concrete. During construction, the static system of the bridge changes from a cantilever before joining, to a frame after joining. At the same time, without additional loads and actions, over time there is a redistribution of stress (internal forces) due to changes in the prestressing force and rheological properties of concrete. Usually, there is a relief of previously more strongly stressed sections/elements and an additional stress of previously less stressed sections/elements. In the bridge, there is a constant redistribution of deformations, stresses and deflections, even for constant loads. That is why knowing the actual behavior of such bridges during construction and use is still an extremely complex task.



#### 1.4. Previous research on post-tensioned concrete balanced cantilever bridges

Due to the sudden increase in the application of cantilever construction, from the 1970s onwards, there is an increased need for research into force distribution during construction and exploitation of post-tensioned concrete bridges built with this method. Research intensified especially in the 1990s with the development of experimental testing techniques and computer nonlinear numerical methods.

One topic of research was the dynamic characteristics and response of structures, covering natural oscillation frequencies, response to wind loads, seismic response, ambient vibration and forced vibration tests, all using numerical and/or experimental methods [P3].

Skrinar and Strukelj (1996) carried out measurements to determine the natural oscillation frequencies of Carinthia balanced cantilever bridge of variable superstructure height during construction in Maribor, Slovenia, and the frequencies were measured for each segment (Figure 22) [11]. Strommen et al. (2001) investigate the influence of dynamic crosswind loading on vertical oscillations during the construction phase of balanced cantilevered bridges. Research is conducted in a wind tunnel, and based on these experiments, a procedure for predicting the dynamic response of the structure was created [12].



Figure 22. Carinthia Bridge in Maribor

(<https://www.ponting.si/en/projects/carinthia-bridge-13.html>)

Schmidt and Solari (2003) also investigate the influence of wind on balanced cantilever bridges and provide a procedure for determining the influence of wind on the superstructure and piers. The conclusion is that some wind effects in different bridge configurations should not be ignored in order to obtain realistic impact on the structure [13]. Morassi and Tonon (2008) perform a series of forced vibration tests to determine the dynamic characteristics of the three span Palu post-tensioned bridge in north-eastern Italy in a seismically active area [14].



Gentile and Bernardini conduct ambient vibration experiments on the Capriate cantilever bridge using radar measurement. The values of natural frequencies and modal shapes that were obtained through accelerometers with a radar sensor matched with the values obtained by conventional accelerometers (Figure 23) [15]. Bayraktar et al. (2009) conducted research on the vibration characteristics of the Komurhan bridge (Figure 24) [16].



*Figure 23. Capriate Bridge*

(Andrew and Annemarie, CC BY-SA 2.0,

[https://upload.wikimedia.org/wikipedia/commons/6/60/Trezzo\\_sull%E2%80%99Adda\\_-\\_ponte\\_stradale.jpg](https://upload.wikimedia.org/wikipedia/commons/6/60/Trezzo_sull%E2%80%99Adda_-_ponte_stradale.jpg))



*Figure 24. Komurhan Bridge*

(Sakowski,

<https://www.highestbridges.com/wiki/index.php?title=File:KomurhanBeamView.jpg>)

Liu et al. determined the dynamic response of a 235 m long three span bridge through a series of ambient vibration tests that were conducted over 12 months [17]. Stathopoulos investigates the dynamic behaviour of the balanced cantilever Metsovo bridge in Greece (Figure 25) [18]. Altunisik et al. (2011) measure the dynamic response of the balance cantilever Gulburn viaduct using ambient vibration tests [19]. In his work, Turan (2012) investigates the dynamic characteristics of balanced cantilever bridges using numerical and experimental methods [20].



*Figure 25. Metsovo Bridge*

(CC BY 4.0, [https://www.researchgate.net/publication/341906106 Bayesian Model-Updating Using Features of Modal Data Application to the Metsovo Bridge/figures?lo=1](https://www.researchgate.net/publication/341906106_Bayesian_Model-Updating_Using_Features_of_Modal_Data_Application_to_the_Metsovo_Bridge/figures?lo=1))

Kudu et al. (2014) determine the dynamic characteristics of the Berta balanced cantilever post-tensioned bridge using the finite element method and modal analysis (Figure 26) [21]. Sumerkan (2019) gives a simplified expression for frequencies in post-tensioned balanced cantilever bridges [22]. Bayraktar et al. (2020) investigate the influence of vertical displacements in the ground near faults on the seismic behaviour of balanced cantilever bridges. The numerical analysis showed that the vertical movements of the ground significantly affect the seismic behaviour of the bridge [23].



*Figure 26. Berta Bridge*

([https://www.highestbridges.com/wiki/index.php?title=File:BertaByswbauerepfl\\_.jpg](https://www.highestbridges.com/wiki/index.php?title=File:BertaByswbauerepfl_.jpg))

Another topic of research was reliability, behaviour and rehabilitation of structures, mostly determined by experimental tests and onsite analyses. In some cases, long term structural monitoring and numerical analysis were used.

Casas (1997) conducted research to determine the reliability partial safety factor on balanced cantilever concrete bridges. The research is conducted on bridges with a span of 80 to 140 m, and an example was made on a bridge with a span of 120 m [24]. Manjure (2001) works on the rehabilitation of balanced cantilever bridges with suspended central part of the span in India, where problems occur during the exploitation phase due to poor concreting and reinforcement detailing [25].

Vonganan conducts structure behaviour research on the Mekong Bridge in Thailand (Figure 27) [26]. Pinmanas et al conduct a study on the Phra-Nangklao post-tensioned balanced cantilever bridge in Thailand (Figure 28) [27]. Ates et al. (2013) investigate the structural behaviour of balanced cantilever bridges taking into account the interaction between the structure and the soil [28]. Chen et al. (2013) conducted dynamic tests and long-term monitoring of the 12-span Newmarket (Auckland, New Zealand) viaduct using wireless sensors shortly after the works were completed [29].



*Figure 27. Mekong Bridge*

(CC BY-SA 3.0,

[https://en.wikipedia.org/wiki/List\\_of\\_crossings\\_of\\_the\\_Mekong\\_River#/media/File:Thai-Lao-Freundschaftsbruecke.jpg](https://en.wikipedia.org/wiki/List_of_crossings_of_the_Mekong_River#/media/File:Thai-Lao-Freundschaftsbruecke.jpg))



*Figure 28. Phra-Nangklao Bridge*

(CC BY-SA 3.0,

[https://en.wikipedia.org/wiki/Phra\\_Nang\\_Klao\\_Bridge#/media/File:New\\_Prangklao\\_Bridge.jpg](https://en.wikipedia.org/wiki/Phra_Nang_Klao_Bridge#/media/File:New_Prangklao_Bridge.jpg))

Pimentel and Figueiras (2017) present a new methodology for assessing the condition of post-tensioned balanced cantilever bridges including experimental and numerical investigations [30]. Caner (2021) analyses the reconstruction of the partially collapsed balanced cantilever post-tensioned bridge Begendik (Figure 29) [31].





Figure 29. Begendik Bridge

(<https://www.highestbridges.com/wiki/index.php?title=File:Begendik13.jpg>)

One other interesting topic of research was the design of post-tensioned concrete bridges built using the balanced cantilever construction method, which focused on superstructure optimisations, bending moment variations, simulation models as well as material and geometric nonlinearities.

Kwak and Son (2004) work on determining the span ratios of balance cantilever bridges through time analyses, in which the main guideline is that vertical displacement does not occur at the edge of the cantilever due to the action of weight and post-tensioned cables for cantilever construction [32]. They are also working on determining the variation of the bending moment over time taking into account construction phases and concrete creep. On the basis of these researches, they provide an expression to obtain the bending moment and its variation by elastic analysis without taking into account the construction phases and creep [33]. Hewson (2007) conducts a study on the balanced cantilever method of bridge construction [34].

Marzouk et al. (2008) develop a special simulation model for balanced cantilever bridges built both with prefabricated and onsite concreted segments [35]. Ates (2011) works on the numerical modelling of balanced cantilever bridges taking into account the time-dependent characteristics of the material. Analyses have shown that time-dependent material characteristics and geometric nonlinearity should be taken into account in order to obtain the correct behaviour of concrete bridges [36]. Bravo et al. (2021) conduct research to assess the seismic displacement of balanced cantilever bridges in the construction phase and in the exploitation phase [37].

Time-dependant effects such as creep and shrinkage during and after construction is another important topic of research focusing on the influence on force and stress distribution, as well as additional deformations.

Pimanmas (2007) investigates the influence of long-term creep and prestressing on the redistribution of bending moments in balanced cantilever bridges, using Pathum Thani as an example (Figure 30). The analysis shows that creep in these cases can increase the value of the negative moment and that rough estimates of creep can lead to wrong results. The exact phases of construction should be taken into account [38]. In the same year, Hedjazi and colleagues investigated the influence of concrete creep on deflections and stresses in post-tensioned balance cantilever bridges. Three-dimensional models are made out of areas with included material nonlinearity and concrete creep [39].

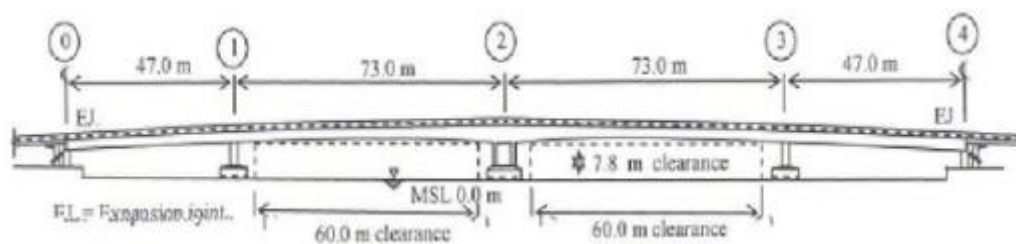
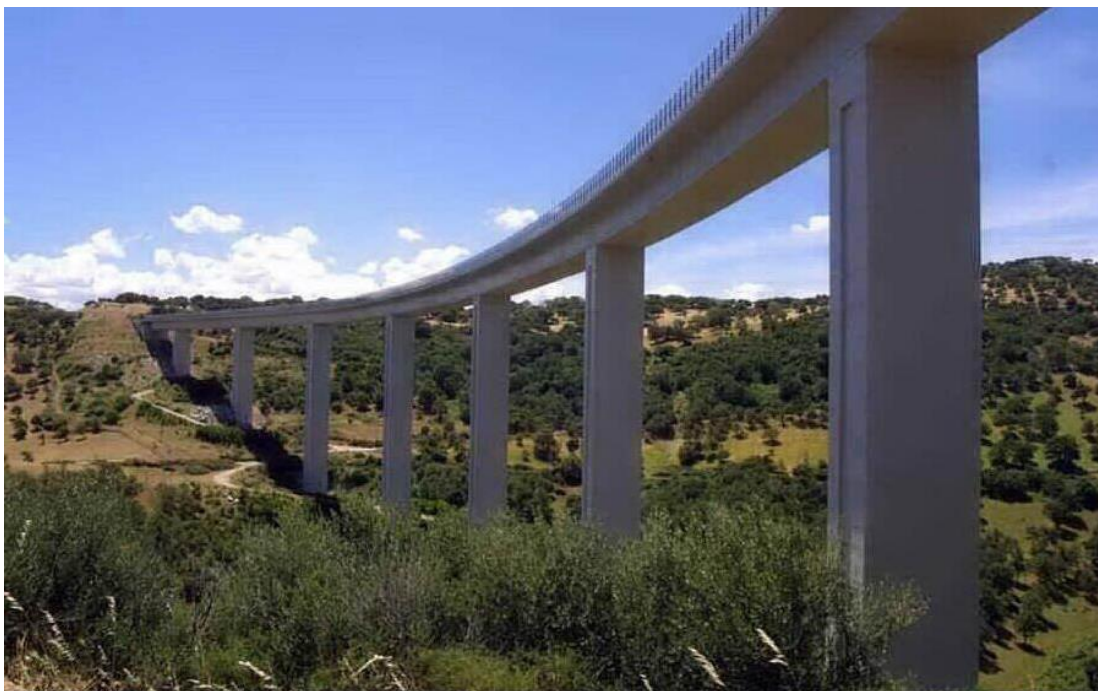


Figure 30. Pathum Thani Bridge elevation

(CC BY-NC, <https://www.researchgate.net/publication/26469481> The effect of long-term creep and prestressing on moment redistribution of balanced cantilever cast-inplace segmental bridge/figures?lo=1)

Altunisik et al. (2010) conduct an analysis of the construction phases of the Komurhan bridge taking into account the time-dependent material characteristics [40]. Malm and Sunquist perform a time-sensitive analysis of Navile and Sa Pruna segmental balanced cantilever bridges (Figure 31). They concluded that larger than expected deflections and higher stresses in the ribs were obtained due to the prestressing of the bottom slab cables. In addition, they show a significant influence of creep in cantilever construction as well as non-uniform drying shrinkage on the completed bridge [41]. Akbar and Carlie (2021) investigate the effects of creep and shrinkage on the long-term deformations of balanced cantilever bridges [42].



*Figure 31. Navile Bridge*

(<https://www.highestbridges.com/wiki/images/d/d2/Navile4.jpg>)

Construction aspects of real bridges are a major research focus, using mostly experimental onsite tests and analyses to cover critical errors, precamber and deflection issues before and after stitch segments, concrete installation and various construction processes.

McDonald et al. (2003) investigate the collapse of the Koror-Babeldaob Bridge in Palau. An analysis of the field inspection was performed and calculations of the bridge before and after reconstruction were made. The result of the analysis shows that the most likely cause of the collapse is damage during the removal of the original concrete road surface [43]. Radić et al. deal with precamber and deflections of balanced cantilever bridges, and provide an expression for the approximate calculation of the required precamber [44].



Jung et al. (2007) work on a simulation that uses field measurements to calibrate the numerical deflection results of balanced cantilevered bridges. The quality of the calibration depends on the experience of the engineer on site, and it is important for the correct joining of the bridge [45]. In the same year, Kronenberg studies the continuous installation of concrete in balanced cantilever bridges. As an example, he cites the Hacka bridge in the Czech Republic, which was completed after only two years of construction (Figure 32) [46].



Figure 32. Hacka Bridge

(<https://www.kudyznudy.cz/aktivity/bungee-jumping-z-mostu-pres-udoli-hacky>)

Kamaitis investigates the connections between segments in prefabricated balanced cantilever bridges. The research covers 5 major bridges, classification and statistics of joint problems [47]. Starossek (2009) presents the project of phase I construction of the Shin-Chon balanced cantilever post-tensioned bridge in Korea [48]. Furunes (2021) analyses aspects of the construction of the 260m-span Trysfjord Bridge in Norway using the balanced cantilever process and implementing programming into design (Figure 33) [49].



Figure 33. Trysfjord Bridge

(Vidar Moløkken/Multilux AS, <https://www.multiconsultgroup.com/projects/tres-fjord-bridge/>)



## **1.5. Dissertation goal and contents**

With a few exceptions, the majority of previously mentioned articles show research done on completed post-tensioned concrete bridges, and a very small number of research was carried out on bridges under construction, following all the stages that the bridge goes through during construction. The research yields useful insight into post-tensioned balanced cantilever concrete bridges. Wind experiments produced a procedure for dynamic response predictions, and showed that wind loads can prove critical and must not be ignored in some cases. Numerical analysis of vertical displacements in the ground near faults showed that the vertical movements significantly affect the seismic behaviour of the bridge. Research done on reliability, rehabilitation and behaviour identify common problems like poor concreting and reinforcement detailing, as well as providing insight to the real structural capacity of the bridges.

The classical design of girder bridges during construction using the balanced cantilever method is usually carried out using elastic analysis procedures including phased construction, but without the effects of creep and shrinkage, or these effects are considered significantly simplified. As shown in this dissertation, the time-dependent effects of creep and shrinkage, as well as the effects of material and geometric nonlinearity, during the construction and exploitation phases are unavoidable, in order to correctly describe the flow of forces and stresses, deflections, as well as the general behaviour of the structure. The importance of the pre-circuit of the structure and the correct calculation for the final connection of the bridge was emphasized.

The balanced cantilever construction process is complex in terms of stress, strain, deformation, geometry (deflection) and safety changes during its construction and use. Each segment of the bridge has differently aged concrete and thus different rheological characteristics: strength, modulus of elasticity, deformations, shrinkage and creep parameters, etc. These characteristics depend on the type of concrete, segment construction duration and the timing of prestressing, formwork release and form traveller position change. In addition, a number of previously listed studies show that the behaviour of bridges built using the balanced cantilever method is a continuous topic of research by the academic and professional community. The accelerated construction of road and railway bridges, with greater spans and more demanding geometry, places greater demands on engineers, designers and contractors in terms of saving materials, reducing the cost and speed of construction, while maintaining the same level of mechanical resistance, stability and reliability. Knowing the exact flow of forces in them becomes the primary task of the designer.

As can be seen from recent research, predicting the behaviour of post-tensioned concrete bridges to all the loads that act on them, left the domain of the classic engineer and the usual linear models from commercial computer programs for structural calculations long ago.

Basically, research generally moves in two directions. The first direction is the examination of constructed bridges with the aim of determining their behaviour, which is usually carried out in situ, on real objects. Such research, although not rare, is unfortunately usually carried out on already built structures, where the influence of the construction method and the changes in the flow of forces that arise with it can only be concluded from the final state of stress and deformation. Another direction is the creation of specific numerical models that are refined with data measured in situ, thus creating more reliable models that can realistically describe the behaviour of the structure. The problem is that most of the data was measured on the finished bridge, so the construction phases, which have a great influence on the final behaviour of the structure, are completely ignored.

This dissertation aims to conduct a comprehensive analysis of the effects of the balanced cantilever construction method on cast-in-place post-tensioned concrete bridges. The primary focus of the analysis is on monitoring the strain and stress in both the concrete and prestressing steel of two bridges with different spans but similar features, during construction. This involves a detailed examination of how the application of the balanced cantilever construction method influences the structural behaviour of the bridges during the construction phase and subsequent to completion.

To achieve this, the dissertation proposes the implementation of an extensive monitoring system. This system will track and record the variations in strain and stress at key points throughout the construction process and during the service life of the bridges. The data collected were then compared with numerical models of the bridges which were refined with specific conditions during construction, allowing for a rigorous assessment of the accuracy and reliability of these models. The inclusion of two bridges with different spans introduces a comparative element to the study. By examining bridges with varying spans but similar characteristics, the research aims to identify any trends, patterns, or differences in the impact of the construction method on structural performance. This comparative analysis adds depth to the findings and enhances the generalizability of the conclusions.

Ultimately, the research seeks to provide valuable insights into the behaviour of cast-in-place post-tensioned concrete bridges constructed using the balanced cantilever method. The combination of field monitoring and numerical modelling is anticipated to yield a holistic understanding of the construction method's implications, enabling the derivation of practical conclusions that can contribute to the improvement of future bridge construction practices.

## **1.6. Methodology**

The methodology of this scientific research is predominantly grounded in experimental research, leveraging state-of-the-art equipment to measure strain and deflection in the context of bridge construction. The use of contemporary tools, such as measuring devices and strain gauges based on changes in electric resistance, ensures precision and reliability in data collection. Additionally, equipment for gathering and processing data is employed to streamline the experimental process and enhance the accuracy of the results.

The experimental research is conducted based on meticulously devised plans and research programs, aligning with the latest advancements in experimental methodologies. This approach is crucial for ensuring the relevance and applicability of the findings to the current state of bridge construction practices. By adhering to modern developments in experimental research, the study aims to provide insights that are not only scientifically rigorous but also directly applicable to real-world scenarios.

The emphasis on properly planned and successfully executed experimental research is highlighted, as it is posited to yield more accurate results than relying solely on numerical models. Experimental research allows for the direct observation of the physical behaviour of the structures under consideration, providing a tangible and empirical basis for analysis. This approach is particularly important when studying the impact of the balanced cantilever construction method on bridges, as it involves on-site measurements and observations during the construction process.

The mention of modern and quality equipment for structure testing underscores the commitment to precision and reliability in the experimental phase. The conducted experimental research is positioned as a control to the numerical models. This means that the empirical data gathered from the experiments will be compared with the predictions and simulations generated by numerical models, and also used to refine the numerical models.

Any disparities or differences in results attributable to the balanced cantilever construction method will be identified and analysed. This comparative aspect enriches the research by offering a comprehensive understanding of how well numerical models align with real-world observations.

In summary, the research methodology prioritizes experimental research using cutting-edge equipment to measure strain and deflection, aligning with contemporary experimental research practices. The combination of rigorous planning, quality equipment, and a comparative approach with numerical models aims to provide a robust analysis of the impact of the balanced cantilever construction method on concrete bridges.

### **1.7. Outline of included papers**

The author of this dissertation has dedicated considerable time to bridge testing, primarily focusing on constructed bridges of various types, widths, spans, and lengths. The Studenčica bridge, with a similar span structure and construction method, was the subject of the initial paper. Subsequently, the author engaged in tests and measurements assessing the behaviour of several other bridges. This paper details the testing of Studenčica bridge under a test load, along with the corresponding measurements. The author's contributions lie in the planning, execution, and data processing of these bridge measurements [P1].

The second paper delves into examining various models for simulating long-term effects in concrete, such as creep, shrinkage, and aging, and their impact on structures. Although concrete bridges constructed via balanced cantilever method are built relatively quickly, the extended duration between the construction of the first and last segments influences secondary effects within the material. Various models from global regulations and literature, crucial for covering these impacts, are discussed and later applied in numerical simulations using the SOFiSTiK software. The paper demonstrates significant difference in results when these effects are disregarded versus when they are considered. The author's contribution lies in integrating and testing different authors' models within the SOFiSTiK software package [P2].

The third paper concentrates on balanced cantilever construction, exploring different performance aspects. While countless technologies and methods exist worldwide, they generally share the same principles but differ in specifics such as support for the pier head and segment adherence. This paper aims to systematically organize and synthesize numerous construction methods, highlighting their similarities and differences. The author's contribution involves extensive literature review and the systematic synthesis of various construction procedures and performance results [P3].

The fourth paper serves as the cornerstone of this dissertation, focusing on in-situ bridge examination, numerical modelling refined with specific data observed during construction, and the comparison between experimental and numerical results, as well as a discussion and conclusions stemming from the comparison. The author undertook nearly all tests and developed numerical models, subsequently processing and comparing the obtained results [P4].

### **1.8. Expected scientific contribution**

The research conducted in the dissertation integrates both experimental and numerical approaches to gather comprehensive insights into the behaviour of cast-in-place post-tensioned concrete bridges constructed using the balanced cantilever method.

The dissertation places significant emphasis on experimental research, particularly by collecting strain data from two distinct cast-in-place post-tensioned concrete bridges constructed with the balanced cantilever method. The utilization of real-world data is crucial for understanding the actual performance of these structures during and after construction. The strain data obtained experimentally provides a tangible and direct observation of the physical behaviour of the bridges. This information serves as a valuable basis for drawing conclusions about the structural response to the balanced cantilever construction method.

Complementing the experimental approach, numerical research is employed to create, confirm, and refine models. The numerical models are essential for simulating the behaviour of the bridges under various conditions. The dissertation aims to not only validate existing numerical models but also to allow new ones to be created, checked and refined based on the experimental strain data.

These numerical models are instrumental in predicting and understanding the impact of the balanced cantilever construction method on the structural integrity of the bridges. Additionally, the numerical research is anticipated to yield broader insights into the behaviour of the structures beyond the specific context of the construction method. The synthesis of experimental and numerical research is designed to provide meaningful and applicable conclusions. These conclusions contribute to a better understanding of the structural behaviour of post-tensioned concrete bridges during and after construction, specifically when employing the balanced cantilever method. The findings not only validate the reliability of numerical models refined with on-site information, but also offer practical guidelines for the design and construction of future balanced cantilever bridges. By leveraging both types of research, the dissertation aims to bridge the gap between theoretical models and real-world performance, enhancing the overall knowledge in the field and informing best practices for future infrastructure projects.

The dissertation adopts a holistic approach by combining experimental and numerical research to gain nuanced insights into the structural behaviour of cast-in-place post-tensioned concrete bridges. The integration of these methodologies aims to provide not only a thorough understanding of the impact of the balanced cantilever construction method but also practical guidelines for the design and construction of resilient and efficient bridges in the future.

In short, the scientific contributions are:

- **Advancing Research:** This dissertation adds to the body of knowledge in the field of bridge engineering and construction. It will serve as a valuable resource for researchers, enabling them to build upon the findings and explore new avenues of inquiry.
- **Design Optimization:** By examining strain analysis in cast-in-place balanced cantilever prestressed concrete bridges, the dissertation contributes to the optimization of bridge design. The insights gained from this study can guide future projects, resulting in more robust and structurally sound bridges.
- **Practical Applications:** The findings presented in this dissertation offer practical implications for engineers, contractors, and project managers involved in the construction of prestressed concrete bridges. It equips professionals with valuable knowledge to optimize construction methods and enhance the safety and efficiency of bridge projects.

## 2. EXPERIMENTAL RESEARCH OVERVIEW

### 2.1. Load tests on bridges preceding the experimental research

Before the experiment took place, over 50 bridges were load tested before traffic opening in order to confirm their safety for public use. On most of the bridges span deflection and strain and stress analysis was performed, along with a dynamic response analysis. The tests proved to be very valuable in gathering experience on data collection on different types of bridges, specifically to locate the best locations for strain gauges and how to best apply them on different materials. In the table below a few larger tested bridges are shown with their most important properties (Table 1).

Table 1. List of larger load tested bridges

Bridge	Length (m)	Span (m)	Material	Type
Studenčica	555	120	Prestressed concrete	Balanced cantilever, box section
Trebižat	380	120	Prestressed concrete	Balanced cantilever, box section
Drivuša	650	40	Prestressed concrete	MSS, box section
Svilaj	660	130	Steel-concrete composite	Box section
Babina Rijeka	385	165	Prestressed concrete	Balanced cantilever, box section

Article “STUDENČICA BRIDGE TESTING” showcases the load testing process and results for Studenčica bridge. The experience on this structure helped with the experimental research since the superstructure on Studenčica bridge is exactly the same as the one on Vranduk 1 bridge, and fairly similar (with differences due to different spans) to Vranduk 2 bridge. As the article shows in detail, deflection and strain/stress measurements taken during load testing align closely with the created numerical model [P1]. This shows that the behaviour of the real-world structure is well described by the numerical model made with line elements, even though the superstructure is a box cross-section. Some differences might be found near supports (abutments and piers), where the superstructure and supports can be modelled with area elements locally to better represent stress trajectories near supports. This leads to a “hybrid” line/area model that accurately represents structural behaviour in all segments, but is still feasible for complex calculations.

## 2.2. Overview of tested bridges

The study examined Vranduk 1 and Vranduk 2 bridges on motorway corridor Vc in Bosnia and Herzegovina. These bridges span the winding Bosna River, navigating around existing infrastructure such as the Doboj – Zenica road and Vrhpolje/Šamac – Sarajevo railway. Each bridge accommodates traffic in opposite directions, with instrumentation located on specific segments above S1 piers: Vranduk 1 on the right and Vranduk 2 on the left.

Vranduk 1 right bridge spans from station km 1+280.00 to km 1+670.00 (Figure 34). It begins with a 76.292 m constant left curve of 755.75 m radius from station 1+280.00 to 1+356.292, followed by a 92.5 m transition curve ending at station 1+448.792. Next, an 86 m transition leads to station 1+546.049, transitioning into a constant right curve with a radius of 694 m over 123.951 m to the bridge's end at station 1+670.00. Warping spans 50 m, with a 2.5% cross slope alternating from left to right over 25 m each. The vertical alignment starts nearly level and gradually slopes down to 1.89%. The roadway is 12.00 m wide, with protective barriers adding 0.46 m. Thus, the total bridge width amounts to 12.92 m, including all components.



*Figure 34.* Vranduk 1 left and right bridge

The bridge has a prestressed concrete superstructure with spans totaling 390.00 m (Figure 35), divided into segments of 80.00 m, 120.00 m, 120.00 m, and 70.00 m. These spans are constructed with a box cross-section. The main spans feature a variable height, transitioning from 6.80 m at the main piers to 3.20 m at the midpoint of each span in a parabolic manner. Sections near the abutments maintain a constant height of 3.20 m throughout.



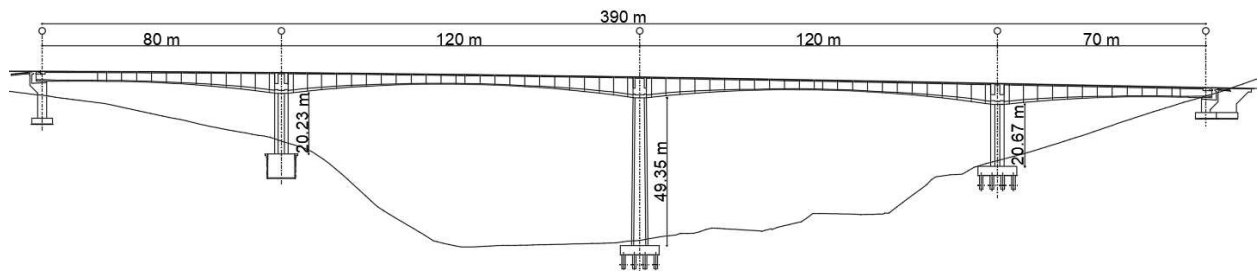


Figure 35. Vranduk 1 right bridge longitudinal section

The bridge features a uniform top slab and box cantilevers: 0.55 m thick at web joints, 0.25 m at ends, and 0.30 m at the box center. Box webs are 0.50 m thick, increasing to 0.65 m above piers with thickening starting 11.25 m from pier edges. The bottom slab is 0.30 m thick (Figure 36), thickening to 0.42 m over 0.60 m at edges, and further to 0.50 m over 5.00 m above abutments. At main piers, it is 1.00 m thick, transitioning 36.25 m from pier edge. Above piers, two transverse diaphragms are 0.70 m and 0.60 m thick, aligned with pillar contours, with 2.00 m high and 1.20 m wide openings at bottom. Abutment-bearing diaphragms are 3.00 m thick, 1.70 m high, and 1.20 m wide. Middle piers are integrated into span structure, with abutments having two bearings each.

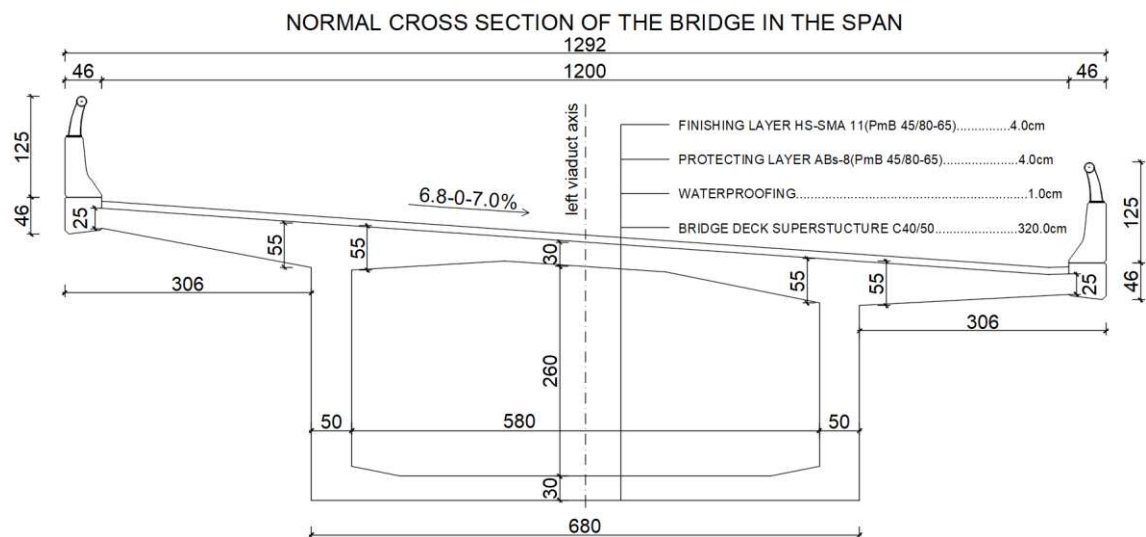


Figure 36. Vranduk 1 bridge characteristic cross section

Pier S2D features a box cross-section of 6.80 x 4.50 m with a 100:1 widening slope to ground contact, integrated into the span construction. S2D has walls 0.70 m thick, while S1D and S3D feature dual walls measuring 1.20 m and 1.40 m thick, respectively. S1D rests on a 9.00 m diameter round well foundation, 8.00 m deep, while S2D and S3D are supported by 13.00 x 13.00 x 3.00 m base slabs connected to 16 piles each, 1.20 m in diameter and 9 m or 19 m long.

## *2. Experimental research overview*

---

U1D and U2D abutments, located on an embankment, have shallow foundations. U1D includes a side wing wall on an 8.00 x 3.50 x 2.00 m foundation, with the main wall foundation at 13.92 x 7.00 x 2.00 m, 3.00 m thick, and supports two bearings. U2D's foundation is 13.92 x 7.00 x 2.00 m, with a 4.40 m high main wall, also 3.00 m thick and supporting two bearings. A right wing wall on a 7.23 x 3.50 x 2.00 m foundation complements U2D. Approach slabs are 4.00 m long at a 10% incline.

The bridge is designed to EN standards for a 100-year lifespan. C40/50 concrete is used for the superstructure and piers, while C30/37 concrete is employed for piles, pile slabs, wells, and abutments. Reinforcement steel is B 500B, and prestressing steel is Y1860 [50].

Vranduk 2 left bridge spans from station km 1+816.00 to km 2+156.00 (Figure 37), with a straight section of 24.75 m followed by a chlothoid curve of 197.00 m length, transitioning to a constant left curve with a 987.50 m radius over 136.24 m. The cross slope on abutment U1L varies from 2.5% to 4.0%. The roadway width is 12.00 m, with 0.46 m protective barriers, totaling a bridge width of 12.92 m.



*Figure 37. Vranduk 2 bridge under construction*

The bridge has a prestressed concrete superstructure spanning 340.00 m, with spans of 95.00 m, 150.00 m, and 95.00 m (Figure 38). It features a box cross-section with varying heights in the main spans and a constant 4.00 m height near the abutments, transitioning from 8.40 m at the main piers to 4.00 m at the span centers.

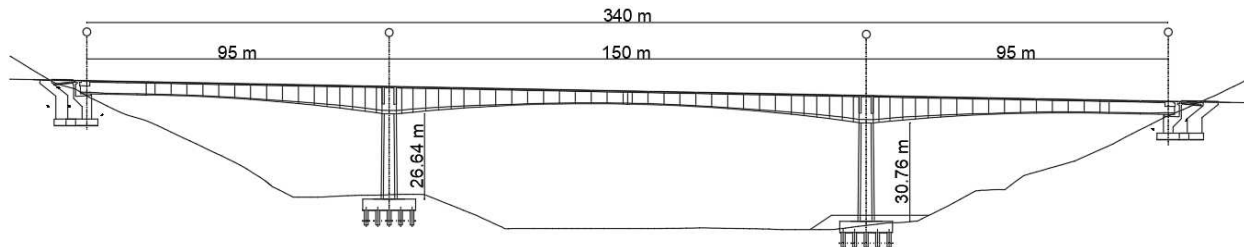


Figure 38. Vranduk 2 left bridge longitudinal section

Top slabs and box cantilevers on the bridge are uniform: 0.55 m thick at the web joints, 0.25 m at the cantilever ends, and 0.30 m in the middle of the box. The webs are 0.50 m thick, increasing to 0.65 m above the piers, with thickening starting 13.25 m from the pier edge (Figure 39). The bottom slab is 0.30 m thick, with a 5.00 m section above the abutments thickened to 0.50 m and 1.00 m above the piers, transitioning over 31.25 m. Above each pier, 0.70 m thick transverse diaphragms align with the outer pier contours, featuring 2.00 x 1.00 m openings. At the abutment bearings, diaphragms are 3.00 m thick with 1.85 x 1.00 m openings. Center piers are integrated into the span structure, while each abutment supports two bearings.

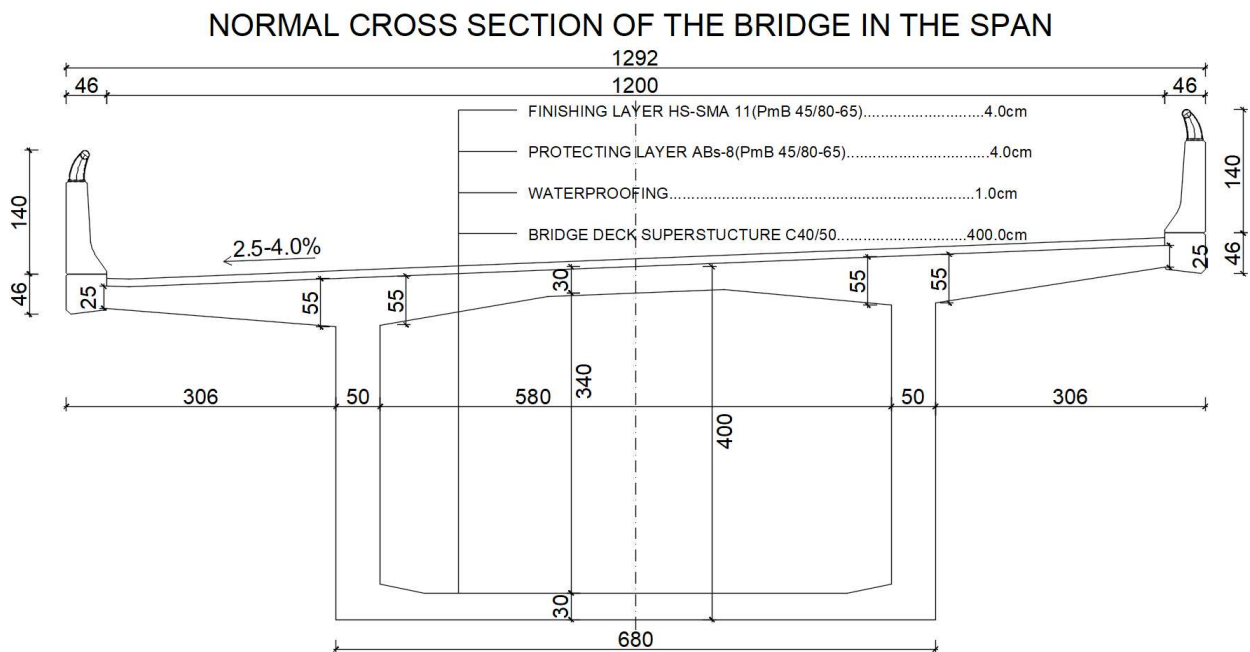


Figure 39. Vranduk 2 bridge characteristic cross section

Piers have a 6.80 x 4.50 m box cross-section where they meet the span construction, with a 100:1 slope widening to ground level. All piers feature 0.70 m thick walls and are supported by 20 piles, 1.20 m in diameter and 12 m long for S1L and S2L, connected to 16.60 x 13.00 x 3.50 m pile slabs.

Abutments U1L and U2L, adjacent to an embankment, rest on shallow foundations. U1L has a 13.92 x 7.00 x 2.00 m foundation with a 7.28 m high, 3.00 m thick main wall supporting bearings on top. Side wing walls are partly founded with foundations of 3.00 m and 6.74 m in length, matching the main wall dimensions. U2L features a 13.92 x 7.00 x 2.00 m foundation with a 5.24 m high, 3.00 m thick wall, also supporting bearings on top, and similar side wing walls with 3.00 m long foundations. Both abutments include 4.00 m long approach slabs at a 10% incline.

The bridge is designed according to EN rules for a 100-year design life. The superstructure uses C40/50 concrete, while the piers, piles, pile slabs, wells, and abutments are constructed with C30/37 concrete. Reinforcing steel is B 500B, and prestressing steel is Y1860 [51].

### **2.3. Monitoring plan and measuring equipment installation**

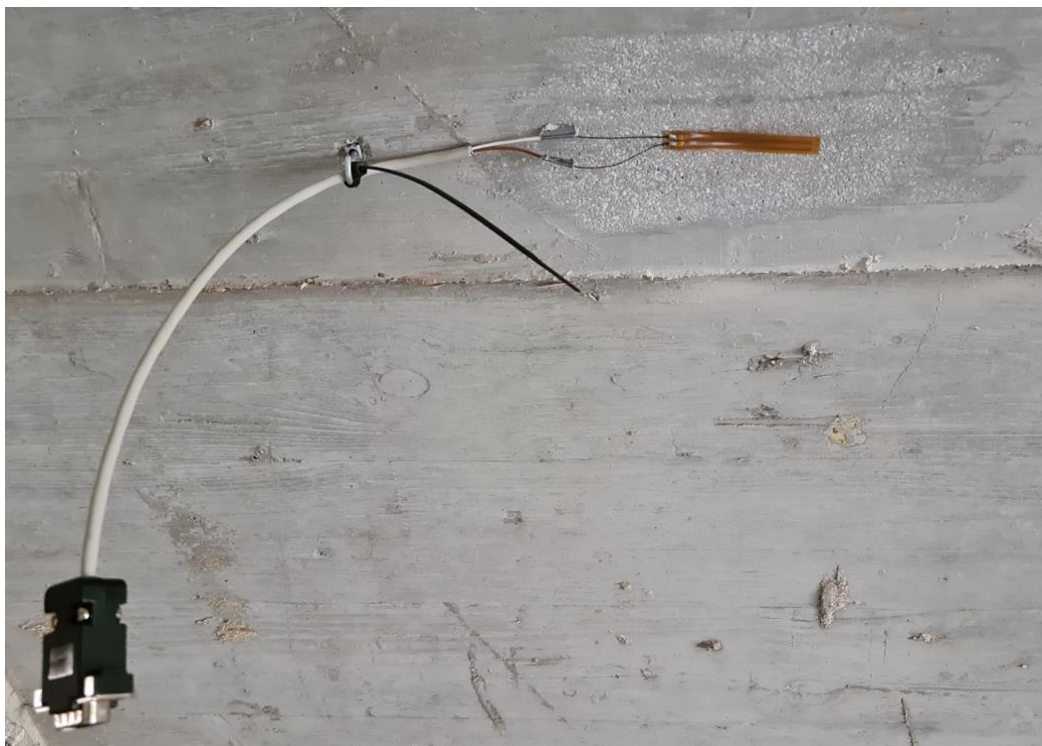
Monitoring on both bridges focused exclusively on the base segments of the first piers, using two strain monitoring devices with 8 measuring points each. This limited scope allowed continuous monitoring throughout all construction phases, tracking strain changes in concrete and prestressing steel. The monitoring period extended from March 25th, 2021 to September 17th, 2021, capturing data during cantilever construction on S1 piers and after prestressing the span tendons. Stress in materials was inferred using strain data and Young's modulus of elasticity, adhering to Hooke's law.

German company HBM's measuring equipment, specifically electrical strain gauges, was employed for data acquisition. These gauges utilize carriers, covering foils, measuring grids, and connections, affixed securely with strong adhesives to ensure consistent deformation measurements. A weak electrical current passing through the measuring grid establishes a reference resistance, which changes with grid deformation caused by stretching or compression.



Strain is calculated from resistance differences, facilitated by the gauge's sensitivity factor (relationship between strain and resistance variations). Linear gauges with a nominal resistance of 120  $\Omega$  were utilized: 50 mm measuring grid gauges for concrete, accounting for its heterogeneous nature, and 3 mm measuring grid gauges for prestressing steel, suitable due to the material's homogeneity and wire size.

Data acquisition was managed using a QuantumX 840A device, featuring 8 input channels via 15-pin connectors and supporting half and full Wheatstone bridge configurations. A quarter Wheatstone bridge configuration, with specialized adapters incorporating precise 120  $\Omega$  metal-film resistors, was employed. These adapters were positioned near the strain gauge (15-20 cm), minimizing measurement deviations induced by additional cable resistance between the strain gauge and the adapter (Figure 40).



*Figure 40.* Strain gauge with the adapter

All strain gauges were prepared beforehand, with 8 extension cables ranging from 17.00 to 24.00 m in length, equipped with a male 15-pin connector on one end and a female 15-pin connector on the other. The strain gauges were soldered onto adapters at one end and connected to the QuantumX 840A data acquisition system. This system boasts 0.05% accuracy and can capture up to 40,000 samples per second through the extension cables (Figure 41).



Figure 41. QuantumX 840A data acquisition system

The QuantumX universal amplifier was linked to a computer via LAN cable, utilizing CatmanEasy software for data acquisition, storage, and analysis. Both the computer and universal amplifier were safeguarded by an uninterruptible power supply (UPS) against short-term power disruptions, which itself was connected to a 220 V power network.

Strain gauges were applied on both bridges to concrete and prestressing steel within the superstructure's cross-section. These gauges were positioned 0.50 m inward from the diaphragm edges toward the span to minimize diaphragm influence. A total of 16 strain gauges were installed. On Vranduk 2 bridge, eight strain gauges were positioned 0.50 m inward from the diaphragm toward the span (Figure 42). Four gauges were installed on concrete, specifically at the inner corners of the box cross-section, offset 0.50 m from the web. Additionally, four gauges were installed on prestressing steel wires: two on tendons during construction of segment 1 and two during construction of segment 7 (Figure 43). These gauges did not compensate for strain due to temperature changes.

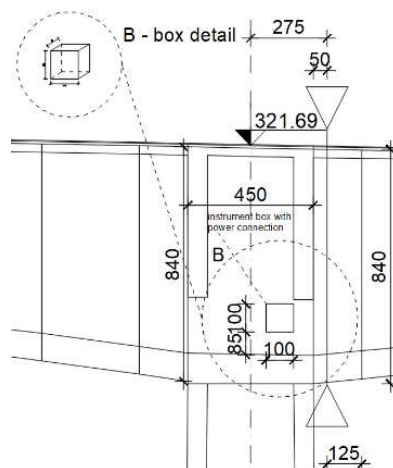


Figure 42. Vranduk 2 longitudinal strain gauge section position



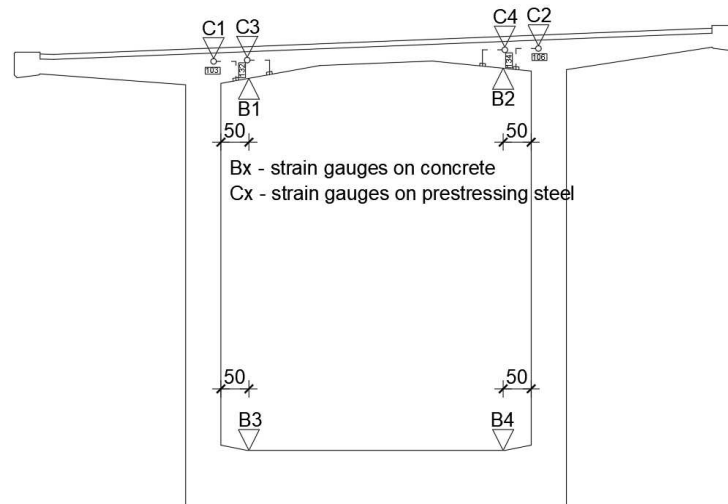


Figure 43. Vranduk 2 strain gauge position in the cross section

On Vranduk 1 bridge, eight strain gauges were installed in a section positioned 0.50 m outward from the diaphragm toward the span (Figure 44). Four gauges were placed on concrete at the corners of the cross-section, and two gauges were mounted on prestressing steel used during the construction stage of the first segment (Figure 45). These gauges were offset by 0.50 m from the webs of the cross-section.

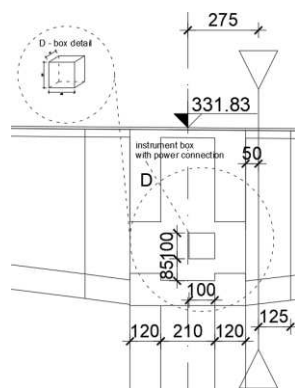


Figure 44. Vranduk 1 longitudinal strain gauge section position

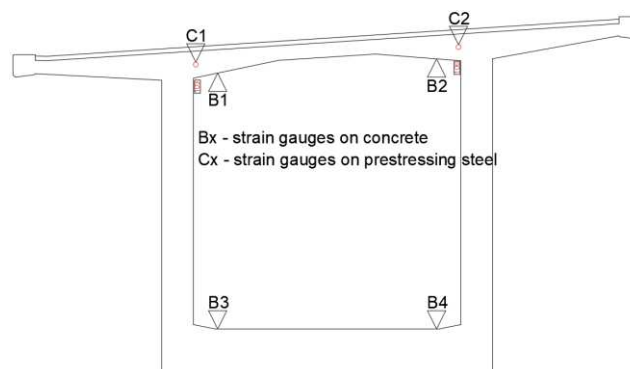


Figure 45. Vranduk 1 strain gauge position in the cross section

Two strain gauges were dedicated for temperature compensation: one was installed on an unloaded concrete sample positioned near the upper slab (Figure 46), and the other on an unloaded prestressing wire sample placed adjacent to the prestressing cable (Figure 47).



Figure 46. Strain gauge on a concrete sample used for temperature compensation



Figure 47. Strain gauge on a prestressing steel sample used for temperature compensation

The procedure for installing strain gauges on concrete was consistent for both bridges. Initially, the concrete surface where the gauge would be affixed was ground using a fine grinder to ensure a suitable surface for adhesive bonding. This step was crucial, especially on the bottom slab where the concrete surface is coarser. Conversely, the top slab already had a smooth surface due to the formwork process. After grinding, a steel hook was secured near the ground area to hold the adapter and gauge before fixing, preventing accidental damage or disconnection during the monitoring process (Figure 48).



Figure 48. Surface prepared for gauge installation

The adapter was secured to the hook with plastic zip ties. The area was cleaned with alcohol to remove dust. A two-component adhesive was applied to the concrete surface, and the strain gauge was positioned in it. Excess adhesive was smoothed out with a plastic film to prevent sticking, and left to cure (Figure 49).



Figure 49. Installed gauge with the adapter after glue hardening

After the adhesive cured, a protective aluminum foil with kneading compound was applied over the strain gauge and lead wires to shield them from weather and minor impacts. Silicone sealed the edges for complete isolation (Figure 50). The gauge's resistance was then checked through the adapter to ensure proper installation and functionality for data acquisition.





Figure 50. Strain gauge after protection

For prestressing steel strain gauges, the wire area was cleaned with alcohol. Gauges and adapters were fixed to nearby steel bars with zip ties. Cyanoacrylate glue secured gauges on wires under a plastic film. After hardening, protective aluminum foil with kneading compound shielded gauges and wires from water (Figure 51). Resistance checks confirmed installation integrity.



Figure 51. Strain gauge installation on prestressing cables (with temperature compensation)

After installing the strain gauges, the adapters were connected to the data acquisition system inside the pier head using extension cables. These cables passed through openings in the diaphragm for concrete gauges and adjacent plastic tubes near the prestressing ducts for steel gauges (Figure 52).



Figure 52. Box containing data acquisition equipment

### **3. NUMERICAL MODELLING AND RESULT COMPARISON**

#### **3.1. Long-term effects in concrete structures**

Before creating the numerical model of both bridges, significant time was spent considering long-term effects in concrete structures, taking into account the delicate nature of balanced cantilever construction process. Since the bridge is built segmentally, each segments has a different concrete age and each segment is prestressed relatively soon (in 2-3 days when the concrete is still young and creep and shrinkage effects are great).

The bridges were monitored during construction, so in order to analyse the behaviour of prestressed concrete bridges during balanced cantilever construction stages, one must consider creep and shrinkage during construction, with changing loads in each step (moving formwork)

Through the paper “Long-Term Effects in Structures: Background and Recent Developments” a lot of recent literature about long-term effects was reviewed in order to choose the best rheology models for these bridge structures. In short, creep, shrinkage, aging and corrosion of concrete were considered, in this case focusing on creep and shrinkage (since aging and corrosion of concrete require a lot longer periods of time to manifest and observe). The paper covers in detail all long-term effects of creep, shrinkage, aging and corrosion, with some examples of buildings collapsing due to these effects. It concludes by stressing the importance of understanding and managing the long-term behavior of construction materials. The adoption of predictive models for creep and shrinkage is recommended as a proactive approach to address these long-term effects [P2].

For this case the Eurocode 2 model based on Fib Model Code 1990 and later Fib Model Code 2010 was adopted (EN 1992-1-1:2004+AC:2010). It is chosen because the model is robust yet relatively simple to use, and it already proved to accurately represent creep and shrinkage effects for different concrete structures, taking into account the age of concrete at the moment of loading, duration of loading, temperature and relative humidity, as well as concrete strength development during ageing.

### 3.2. Software used for numerical modelling

Computer FE software SOFiSTiK was used for all numerical models. Its modular framework, a hallmark of the software, has greatly facilitated the work of bridge designers across generations. It covers a broad spectrum of tasks, from the parametric design of frame bridges to the intricate calculations involved in force optimization and shop form computations for large span post-tensioned concrete and steel bridges. The software boasts specialized functionalities such as soil-structure interaction, wind dynamics, and seismic simulations, broadening its applicability. In addition to the CADINP parametric input language, SOFiPLUS, a graphical interface based on Autodesk AutoCAD, provides modern input capabilities through Computer Aided Bridge Design (CABD) technology. The computation tasks are managed through the graphical workflow of SOFiSTiK Structural Desktop (SSD). Key features of the software include:

- CABD Technology: Allows axis-based input with parametric master cross sections. Variables and formulas enable the description of complex models with automatic finite element meshing.
- SOFiPLUS: Facilitates AutoCAD-based input for 3D structures with a graphical editor for tendons and cross-sections.
- Finite Element (FE) sectional analysis for concrete, steel, and composite sections, accounting for shear deformations, warping, and nonlinear temperature effects.
- Consideration of sectional construction stages, such as precast sections with in-situ concrete.
- Construction Stage and Design Manager (CSM): Facilitates construction stage analysis and design management for various construction methods and codes.
- Enhanced features include nonlinear shell elements (accounting for cracked concrete and steel yielding), rolling stock analysis, and seismic design.
- Building Information Modelling (BIM) compatibility through the IFC interface, enabling data exchange with Dynamo and Revit.

One of the standout features of SOFiSTiK is its open-source nature, allowing users to modify the code for calculations to suit their specific requirements. This includes adjusting material properties (both linear and nonlinear) and utilizing a robust material and geometric nonlinear solver with customizable options to tailor the calculations for different purposes.



### 3.3. Numerical models of the bridges

Hybrid 3D FEM models of Vranduk 1 and Vranduk 2 bridges were created in SOFiSTiK software to compare stress/strain values with measurements. Two models were made for each bridge: one considering creep and shrinkage effects during construction, and one without. This aimed to analyze how these factors affect stress/strain in the bridges. Structural lines were used for most of the bridge, with detailed cross-sections assigned. Area elements were specifically used at pier heads and S1 piers for accurate strain analysis (Figure 53 and Figure 54).

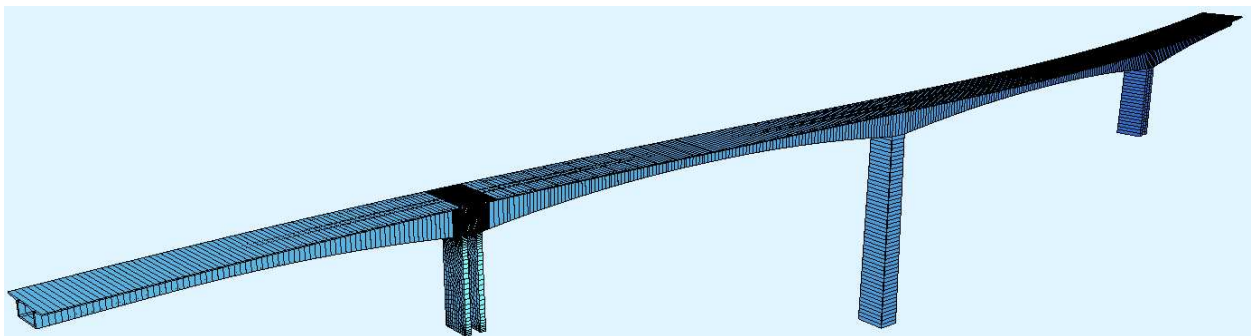


Figure 53. Vranduk 1 bridge model

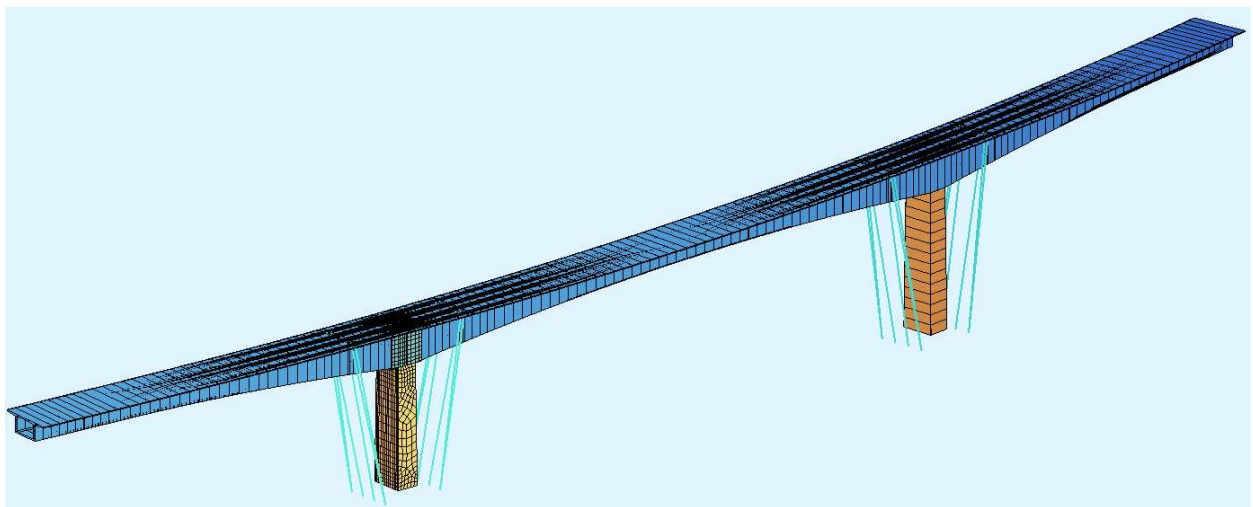


Figure 54. Vranduk 2 bridge model

The bridge layout is based on design drawings [50, 51]. Longitudinal slopes of up to 1.89% on Vranduk 1 and Vranduk 2 are deemed negligible. Horizontal curves are crucial for precise modeling due to their impact on segment precamber, cable positioning affected by creep and shrinkage, and cantilever behavior during construction. SOFiPLUS is used to accurately input axis geometry and define bridge segments and horizontal curves (Figure 55).

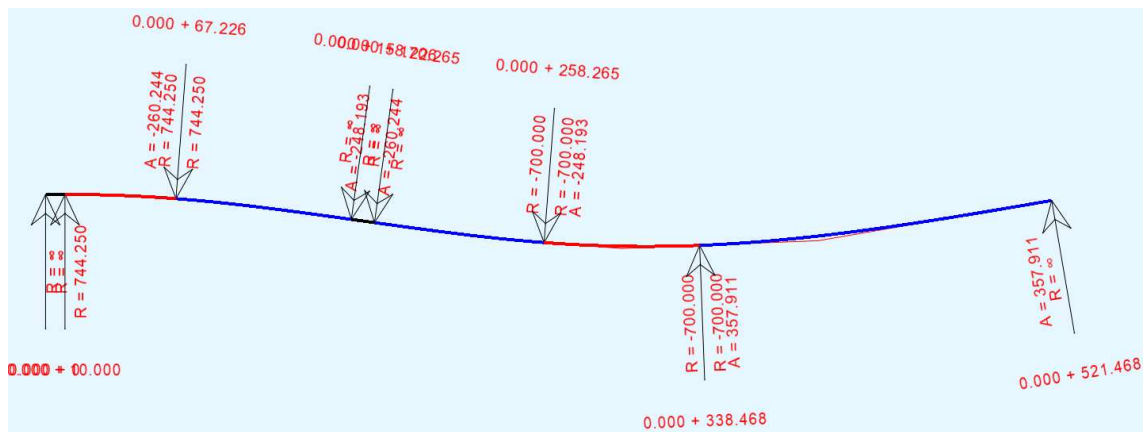


Figure 55. Vranduk 1 bridge horizontal axis allignment

After setting the layout, pier cross-sections remained unchanged due to simplicity. Superstructure sections were adjusted: the box top slab was leveled horizontally without a cross slope to minimize structural impact and simplify input. The parapet was also simplified by extending the top slab to the parapet's end and compensating for the missing self-weight with additional loads (Figure 56).

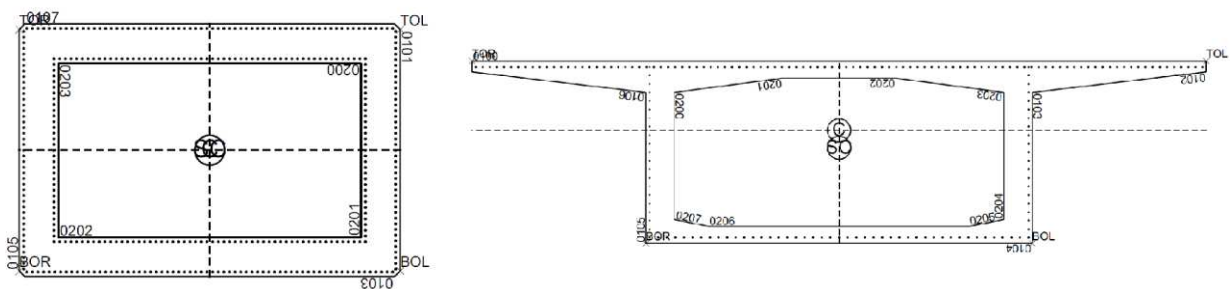


Figure 56. Example of generated cross sections: pier (left) and superstructure (right)

The superstructure is highest on piers and lowest in the middle of the spans. Upper box slab follows the longitudinal slope and is horizontal in the model, while the lower slab follows a parabolic trajectory. That means that every segment of the bridge cantilever has different start and end cross sections. In total 13 superstructure cross sections are input for Vranduk 1 bridge, and 17 for Vranduk 2 bridge (Table 2 and Table 3). Vranduk 1 superstructure and piers are input with C40/50 concrete and B500B reinforcement, while on Vranduk 2 the superstructure is input with C40/50 concrete and piers are input with C30/37 concrete. Reinforcement is B500B. Prestressing cables for both bridges are input with Y1860 prestressing steel.

Table 2. Vranduk 1 superstructure cross sections

Section number	Distance from pier edge (m)	Section height (m)	Web thickness (m)	Lower slab thickness (m)
1	0	6.80	0.650	0.950
2	1.75	6.58	0.627	0.950
3	6.5	6.02	0.563	0.950
4	11.25	5.50	0.500	0.846
5	16.25	5.02	0.500	0.737
6	21.25	4.59	0.500	0.628
7	26.25	4.22	0.500	0.518
8	31.25	3.91	0.500	0.409
9	36.25	3.66	0.500	0.300
10	41.25	3.46	0.500	0.300
11	46.25	3.31	0.500	0.300
12	51.25	3.23	0.500	0.300
13	56.25	3.20	0.500	0.300

Table 3. Vranduk 2 superstructure cross sections

Section number	Distance from pier edge (m)	Section height(m)	Web thickness (m)	Lower slab thickness (m)
1	0	8.40	0.650	1.000
2	1.75	8.19	0.630	1.000
3	5.25	7.78	0.591	1.000
4	9.25	7.33	0.545	0.910
5	13.25	6.92	0.500	0.819
6	17.25	6.53	0.500	0.729
7	21.25	6.17	0.500	0.639
8	26.25	5.76	0.500	0.526
9	31.25	5.39	0.500	0.413
10	36.25	5.06	0.500	0.300
11	41.25	4.78	0.500	0.300
12	46.25	4.54	0.500	0.300
13	51.25	4.35	0.500	0.300
14	56.25	4.20	0.500	0.300
15	61.25	4.09	0.500	0.300
16	66.25	4.02	0.500	0.300
17	71.25	4.00	0.500	0.300

Cross sections and segments of the superstructure and piers were defined using construction lines. The finite element mesh interpolated between these segments. Piers and abutments were connected to the superstructure using constraints: line elements connected them, while specific sections used point constraints. Piers S1 incorporated area elements for the pier head, connected to the structure via point-to-line constraints (Figure 57 and Figure 58).

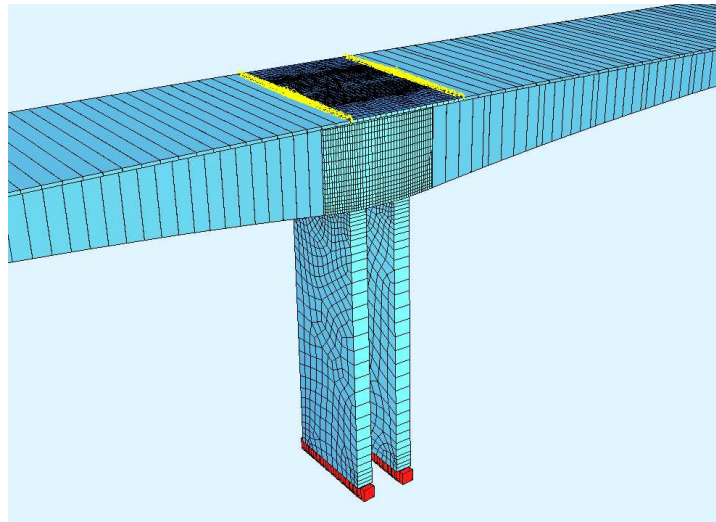


Figure 57. Vranduk 1 S1 pier

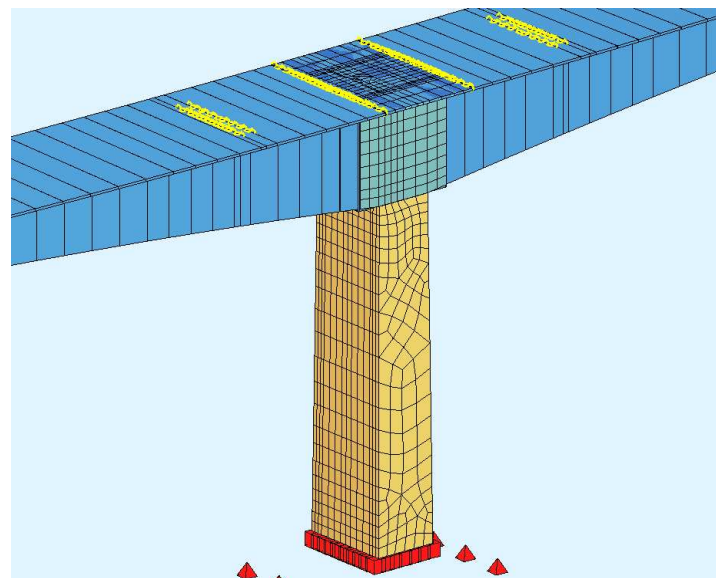


Figure 58. Vranduk 2 S1 pier

Structural areas were modeled realistically with slab thickness using an automatically generated finite element mesh. Abutments and foundations were simplified with point and line supports due to their minimal structural impact. Piers were fixed, while abutments had roller supports allowing movement and rotation.

All prestressing cables were modeled individually as post-tensioned cables embedded in concrete and grouted immediately after stressing, with 19 strands per cable totaling 28.5 cm<sup>2</sup> cross-sectional area.

Vranduk 1 bridge employed 168 prestressing cables: 120 for balanced cantilever stages in the top slab and 48 for the bottom slab during exploitation (Figure 59). Above each pier head, 40 construction stage cables (20 per web) were anchored on completed segments: 6 cables on segments 1-2, 4 cables on segments 3-7, and 2 cables on segments 8-11. Main spans had 16 cables in the lower slab (8 per web) anchored on segments 5-8, and end spans had 8 cables (4 per web) anchored on two segments [50].

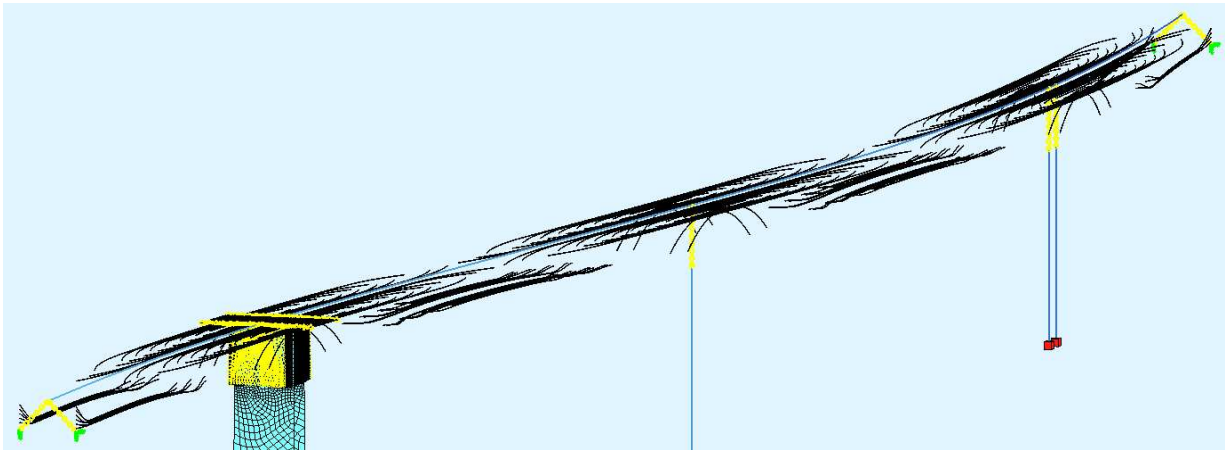


Figure 59. Vranduk 1 prestressing cables

Vranduk 2 bridge uses 174 prestressing cables: 124 for top slab construction stages and 50 for bottom slab during operation (Figure 60). Above each pier head, 62 construction stage cables (31 per web) are anchored: 6 cables on segments 1-3, 4 cables on segments 4-13, and 2 cables on segments 14-15. Main span has 20 cables in lower slab (10 per web) on segments 8-12. End spans have 14 cables (7 per web): 4 cables over three segments and 2 cables over one segment. Additionally, 2 cables in upper slab of main span manage sudden loads [51].

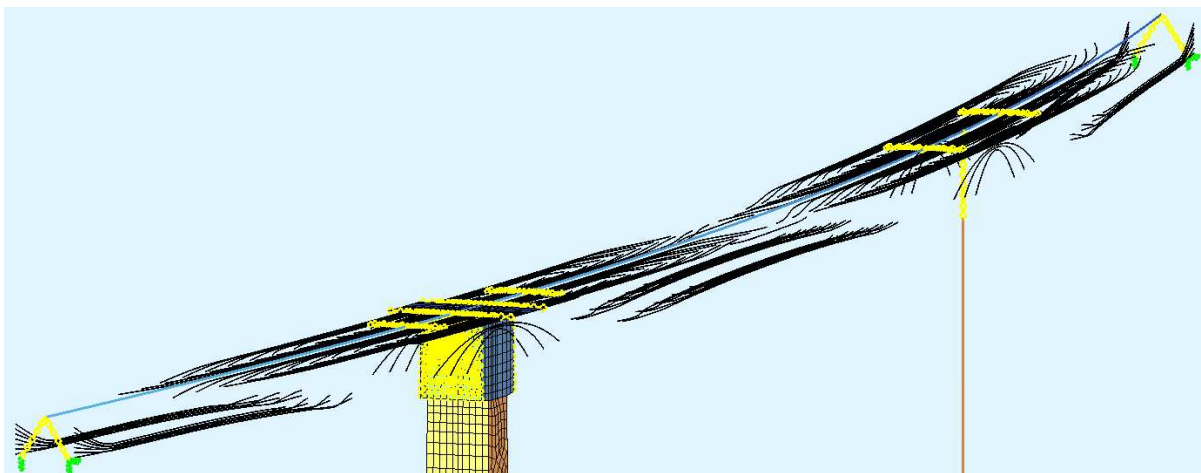


Figure 60. Vranduk 2 prestressing cables

Loads considered during and after construction of the bridges include dead loads of structure segments, additional elements like parapets and barriers, asphalt, waterproofing, drainage, and installations. Prestressing, creep, shrinkage, and form traveler construction loads are also accounted for. Construction stages are pivotal for balanced cantilever bridges. Initial work begins with pier and pier head construction. Subsequent stages are detailed for each superstructure segment:

XX10 S1-SEG1	-segment dead load and stiffness activated
XX11 S1-SEG1 prestressing	-prestressing of a previously activated segment
XX14 S1-SEG2 form traveller	-form traveller is moved for the next segment
XX15 C+S	-creep and shrinkage step
XX17 S1-SEG2 fresh concrete	-concrete weight of next segment, no stiffness
XX20 S1-SEG2	-next segment dead load and stiffness activated

Form traveler and fresh concrete loads are managed by activating and deactivating them for each segment. Vranduk 1 bridge involves 322 construction phases, while Vranduk 2 has 312 construction phases (Figure 61 and Figure 62).

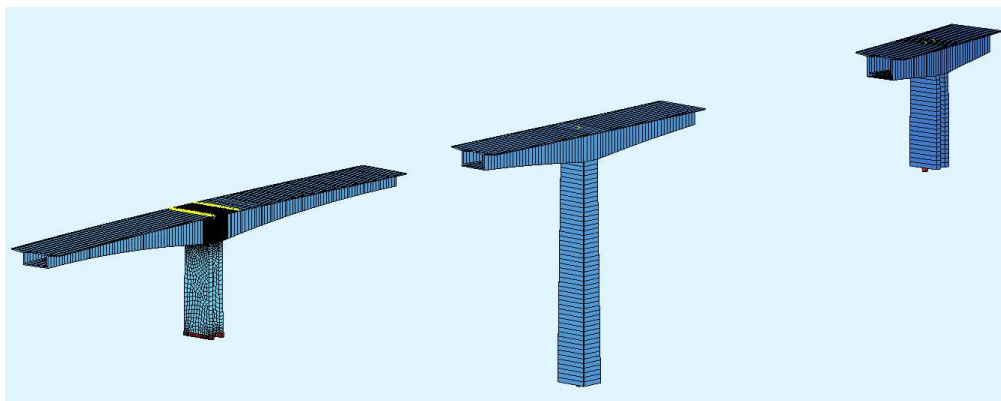


Figure 61. Vranduk 1 construction stage

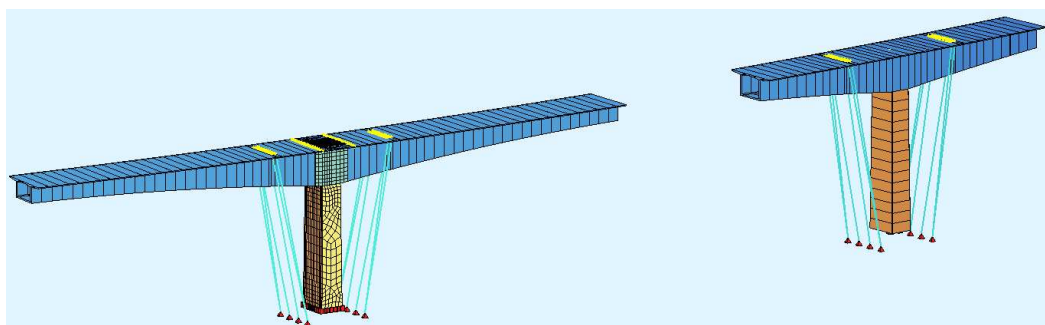


Figure 62. Vranduk 2 construction stage



Construction stages are analyzed using full geometrical nonlinear analysis with nonlinear material properties, employing the SLS material curve for realistic results (Figure 63). Creep and shrinkage calculations follow EN 1992-1-1:2004+AC:2010 [52], with each time step specified for humidity (70%) and temperature (20°C). These values, as well as real construction stages observed during construction are crucial elements to refine numerical models and yield results that better describe structural behaviour in multiple segments. Creep values are computed individually for each load part to consider backward creeping. Segments are positioned tangentially to the existing structure to accurately calculate segment positions and deflections. The initial loading time is input separately for each activated part due to varying construction durations. Losses in prestressing cable forces from steel relaxation, and creep and shrinkage effects on concrete, are meticulously calculated and incorporated. Concrete stiffness development considers temperature-adjusted concrete age T1 as per the CEB-FIP model code 1990 [53].

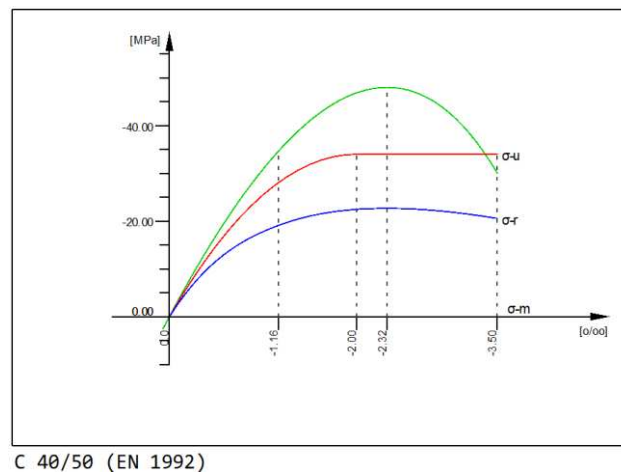


Figure 63. Stress-strain concrete diagram used for the numerical model (green curve)

### 3.4. Result comparison

Vranduk 1 bridge was monitored for 77 days, and Vranduk 2 bridge for 107 days. Sampling occurred at a rate of 1 sample every 50 seconds, totaling 1728 samples per day per measuring point. Throughout each day, variations in the strain curve occurred due to temperature changes and different construction stage loads (Figure 64) [P4].

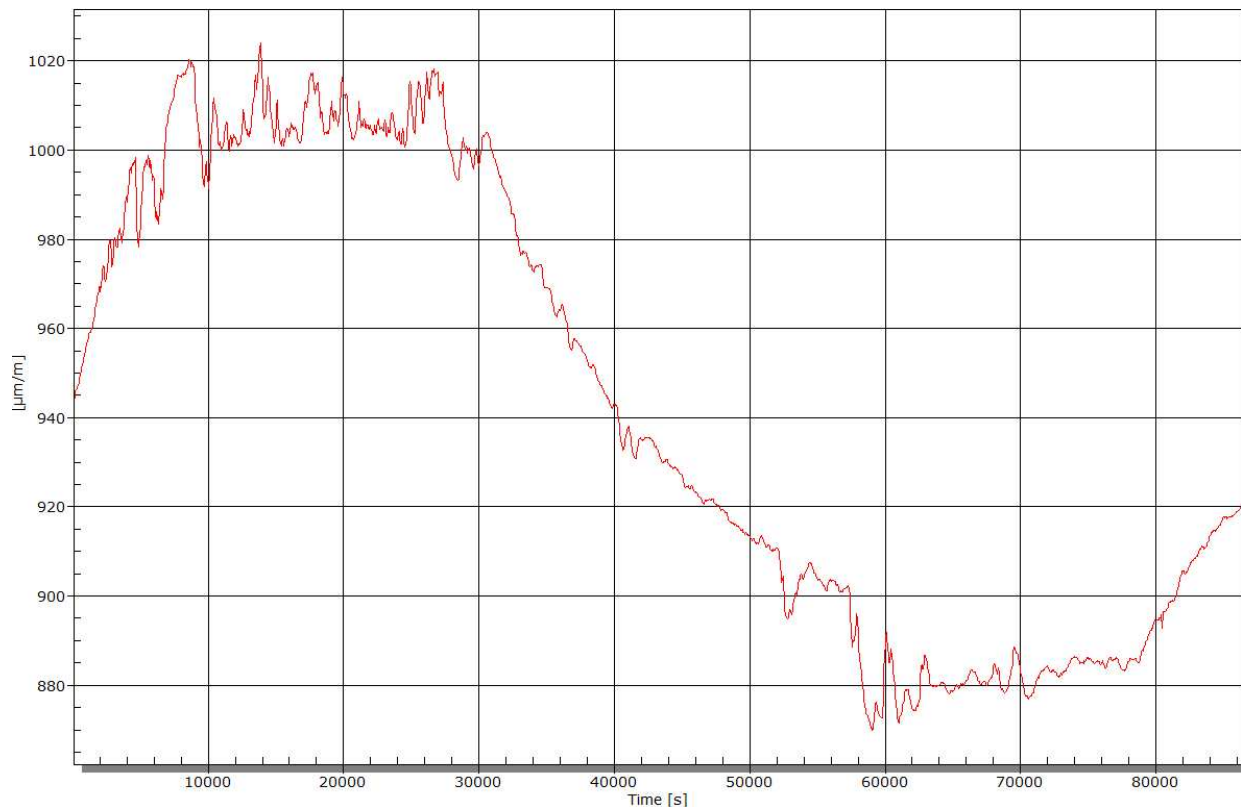


Figure 64. Example of a single day strain-time diagram change

To present clear results, each measuring point's diagram during the monitoring period was created using a single daily reference sample, consistently taken at the same time. Original strain measurements were converted to stress using Hooke's law. The elastic modulus for C40/50 concrete, as per EN1992-1-1:2004, is 35220 MPa, applied to the strain data to derive stress values. Prestressing steel Y1860, with an elastic modulus of 195000 MPa, was similarly considered.

However, due to damage to prestressing steel sensors during cable grouting, the data's small sample size prevented extracting meaningful conclusions at this stage. Results from strain and stress, obtained from numerical models including and excluding creep and shrinkage effects, were compared with measured data for comprehensive analysis.

The strain results comparing measured strain with numerical results with and without creep and shrinkage are shown below (Figure 65 – Figure 72). Furthermore, graphs showing the compressive stress through points B1 to B4 on both bridges relative to characteristic concrete strength  $f_{ck}$  are shown (Figure 73 – Figure 80). In addition to strain and stress, vertical deflections during bridge construction were monitored and the measured results are compared to numerical precamber calculations (Figure 81 and Figure 82) [P4].

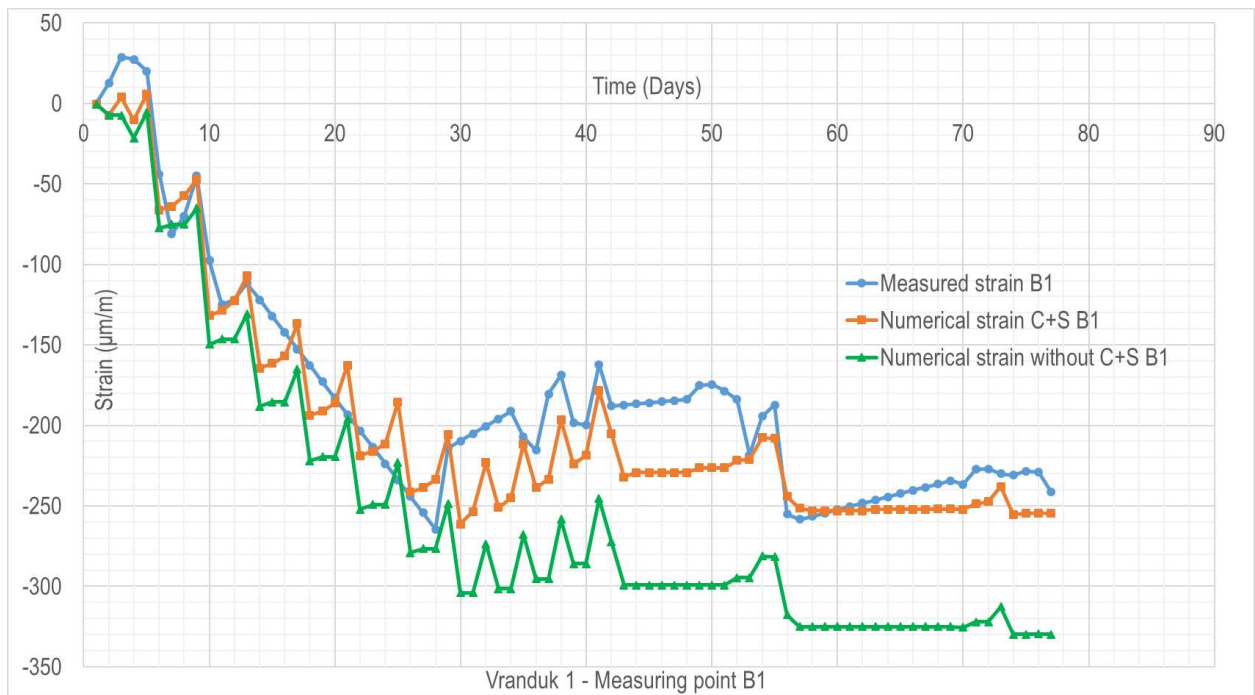


Figure 65. Vranduk 1 – measured and numerical strain with and without creep and shrinkage (C+S) – point B1

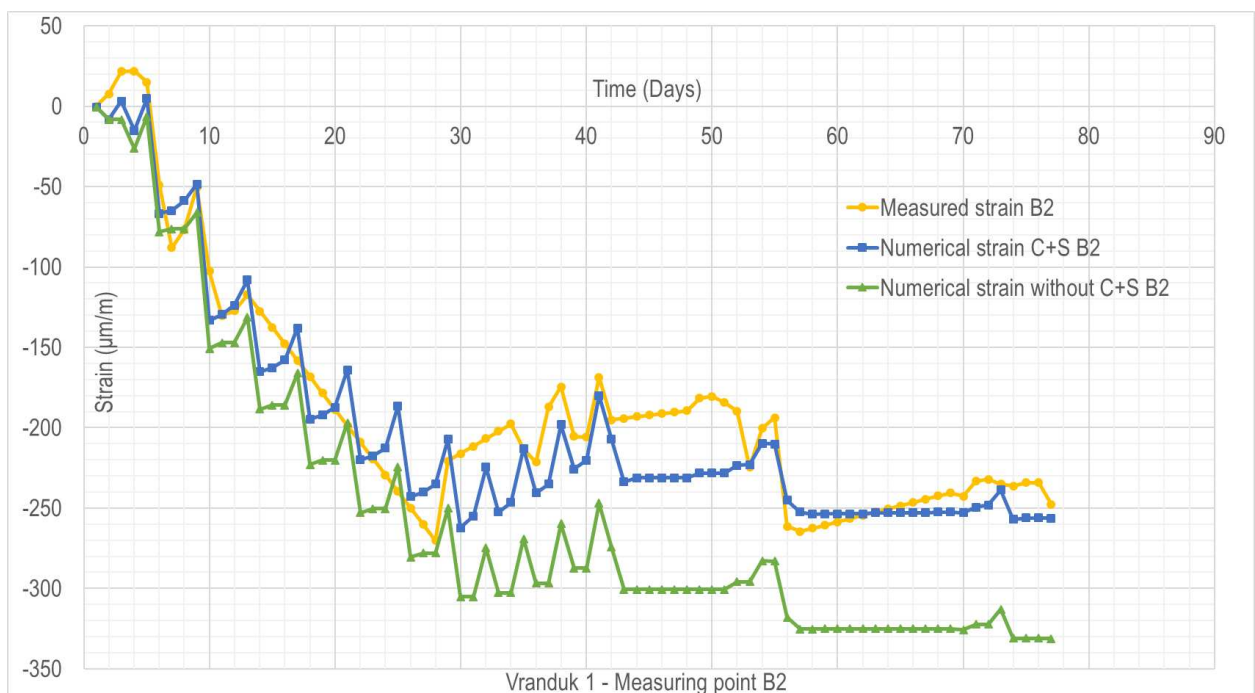


Figure 66. Vranduk 1 – measured and numerical strain with and without creep and shrinkage (C+S) – point B2

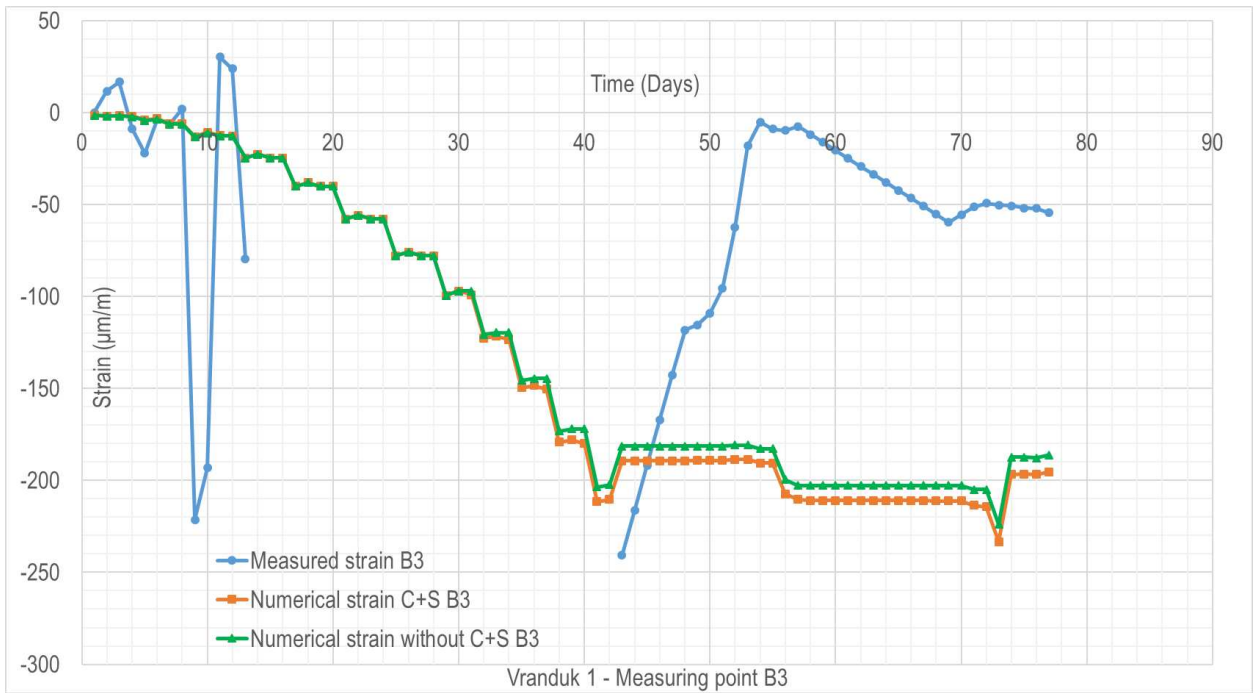


Figure 67. Vranduk 1 – measured and numerical strain with and without creep and shrinkage (C+S) – point B3

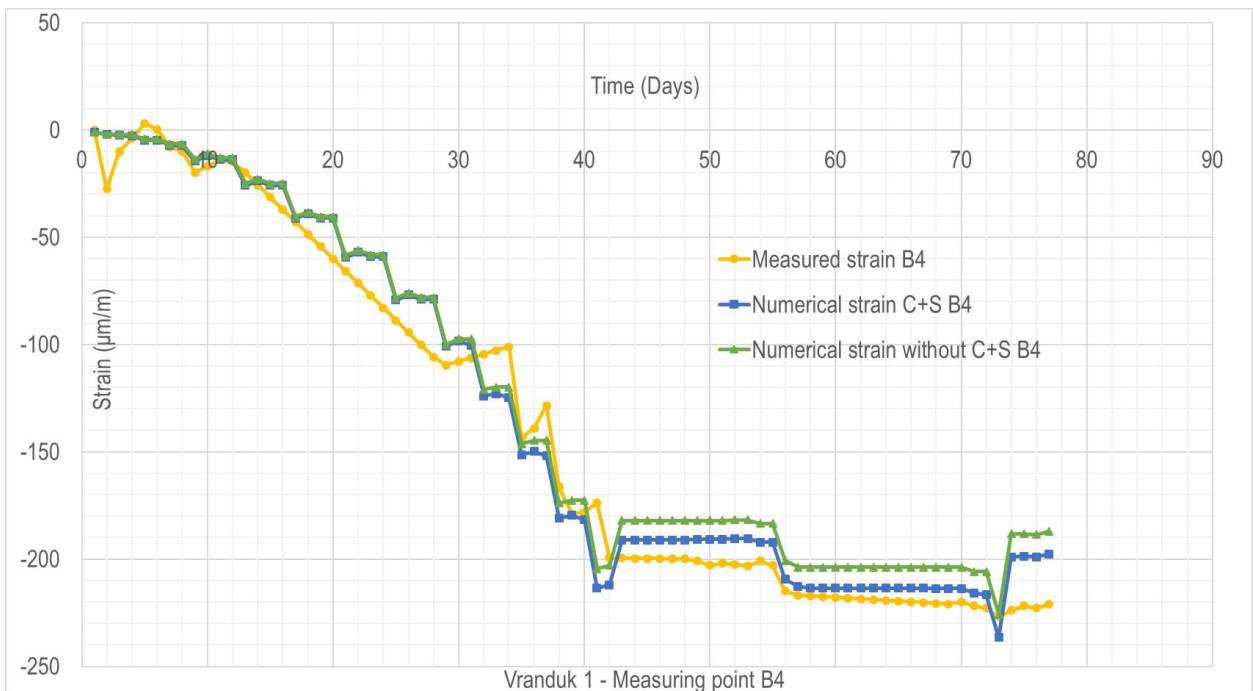


Figure 68. Vranduk 1 – measured and numerical strain with and without creep and shrinkage (C+S) – point B4

### 3. Numerical modelling and result comparison

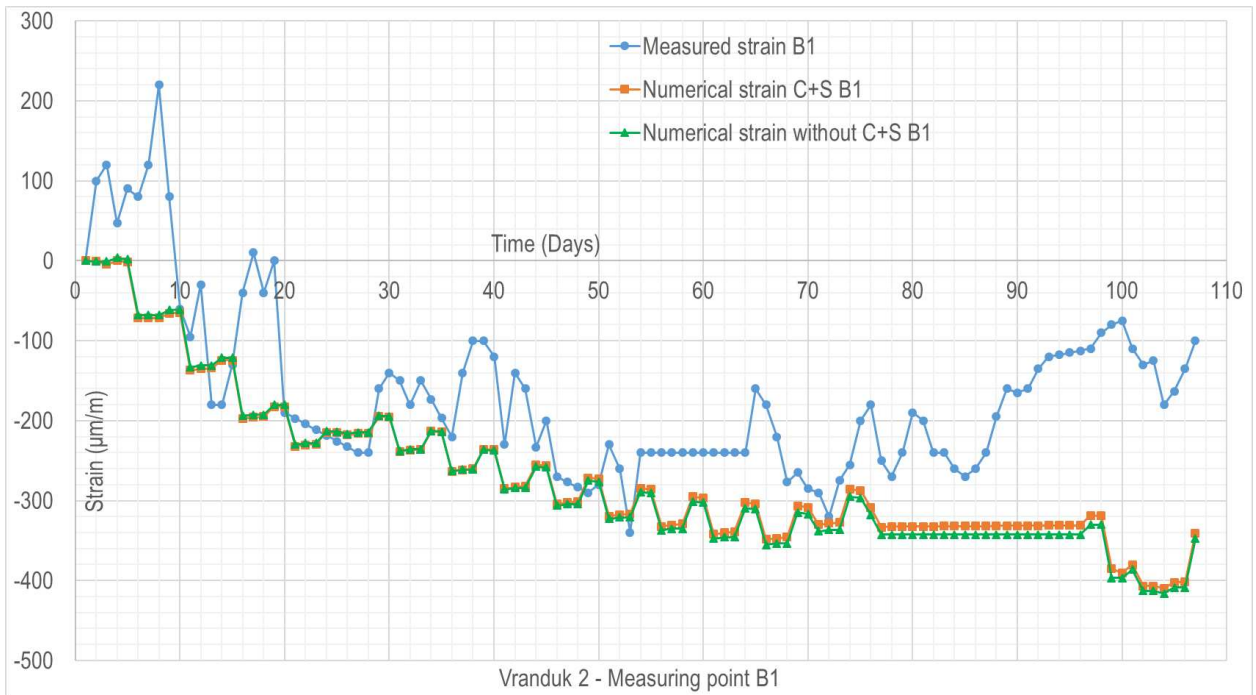


Figure 69. Vranduk 2 – measured and numerical strain with and without creep and shrinkage (C+S) – point B1

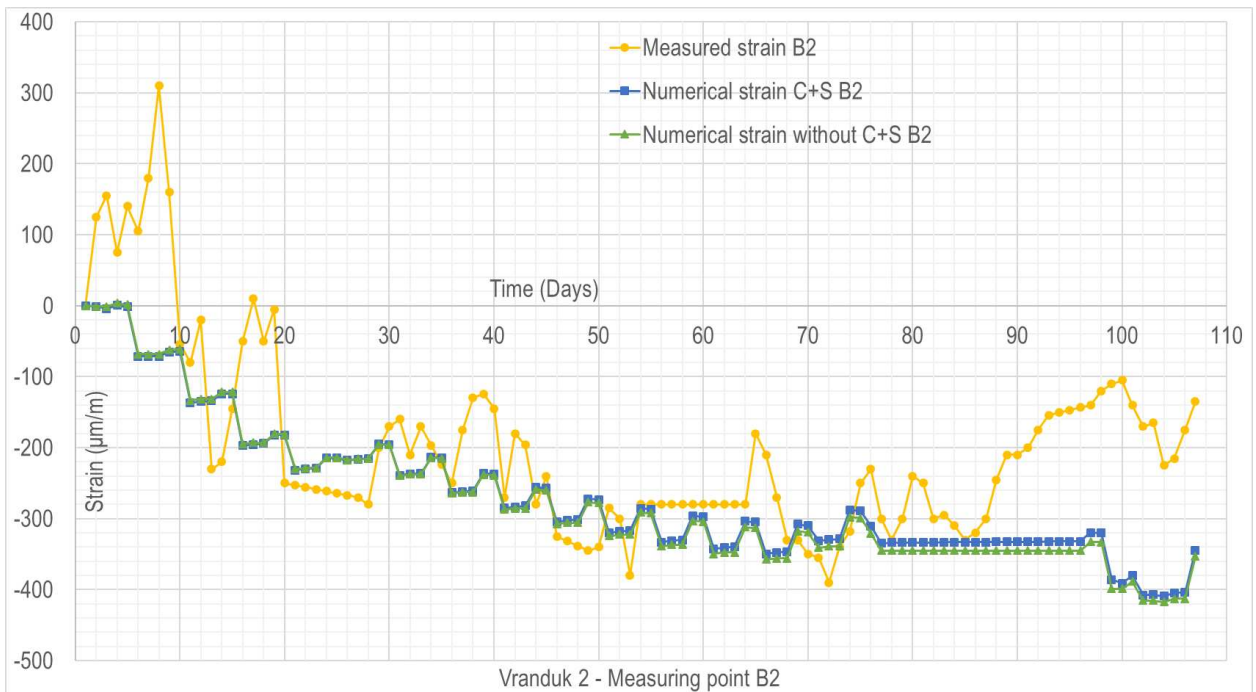


Figure 70. Vranduk 2 – measured and numerical strain with and without creep and shrinkage (C+S) – point B2



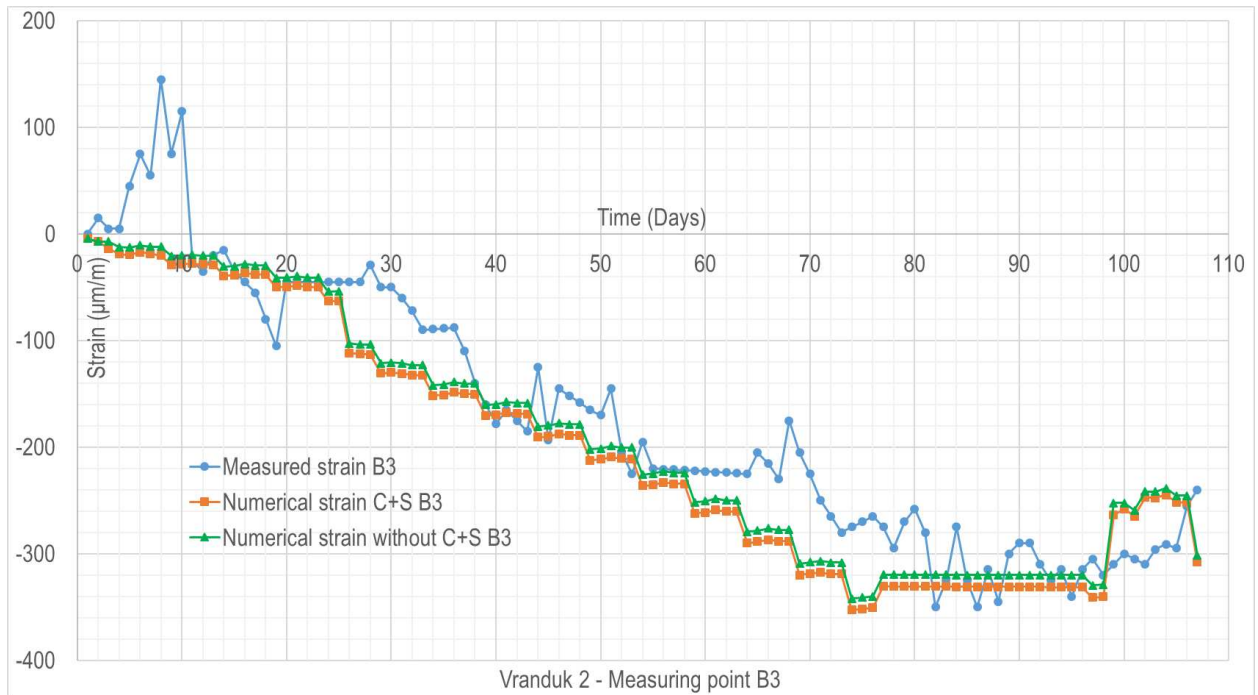


Figure 71. Vranduk 2 – measured and numerical strain with and without creep and shrinkage (C+S) – point B3

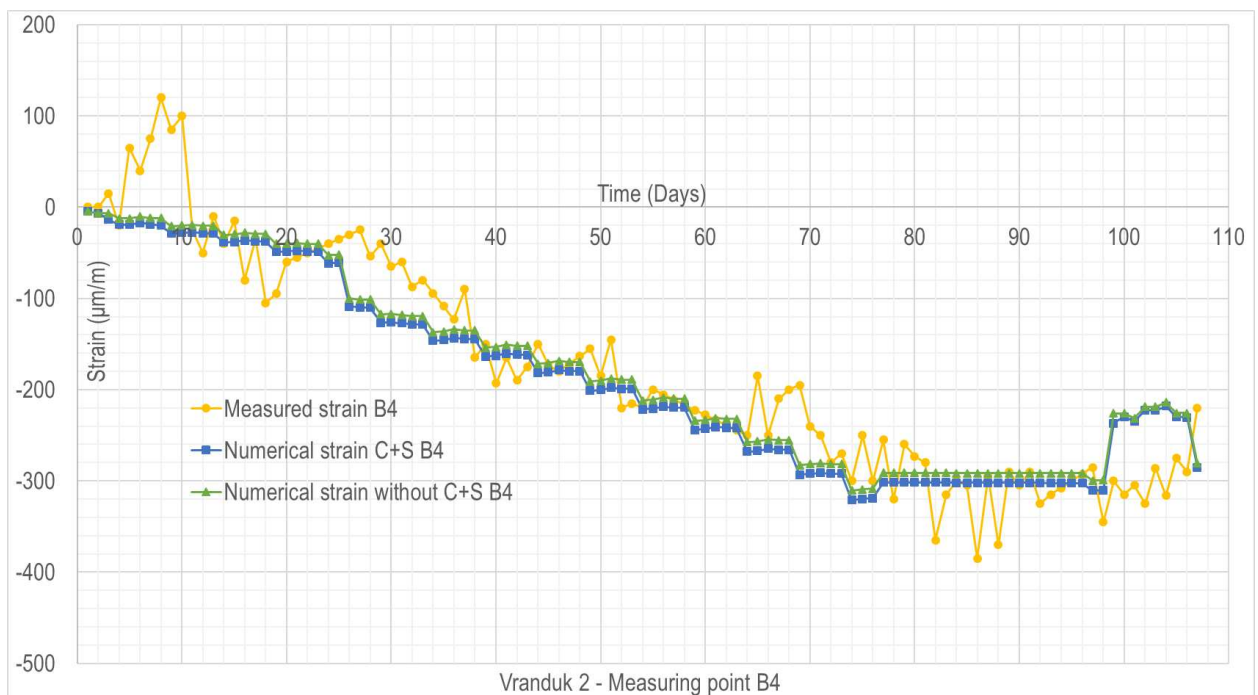


Figure 72. Vranduk 2 – measured and numerical strain with and without creep and shrinkage (C+S) – point B4



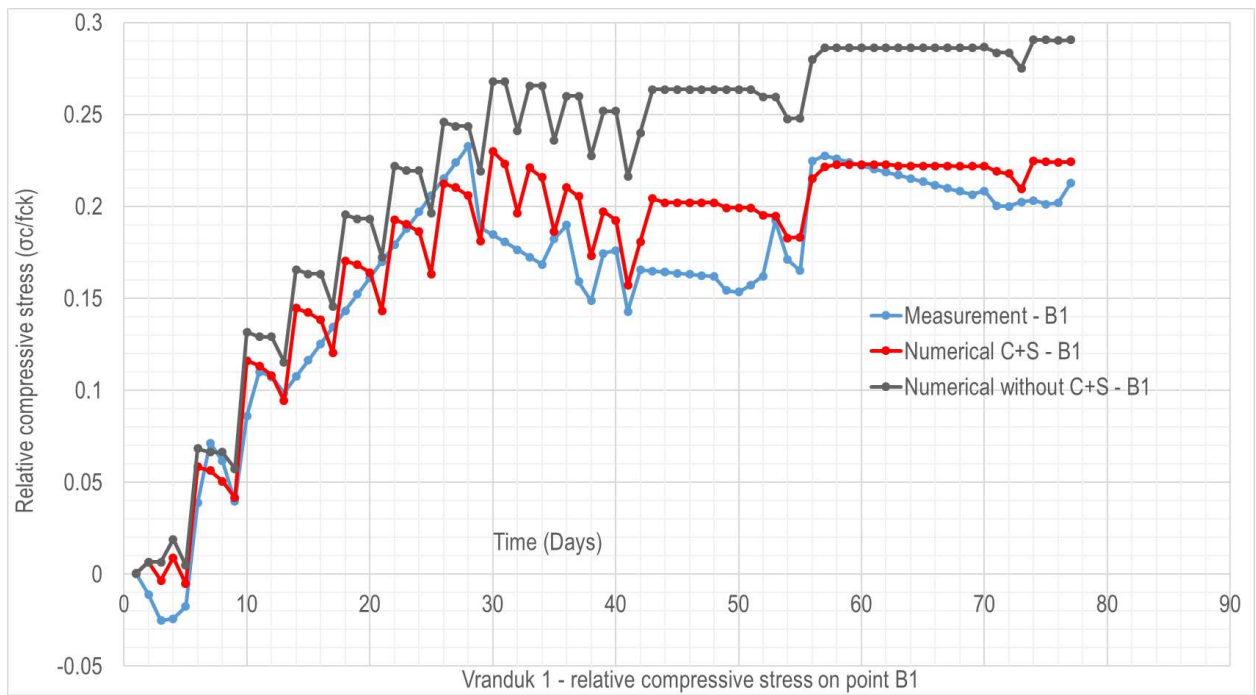


Figure 73. Vranduk 1 – relative compressive stress ( $\sigma_c/f_{ck}$ ) – point B1

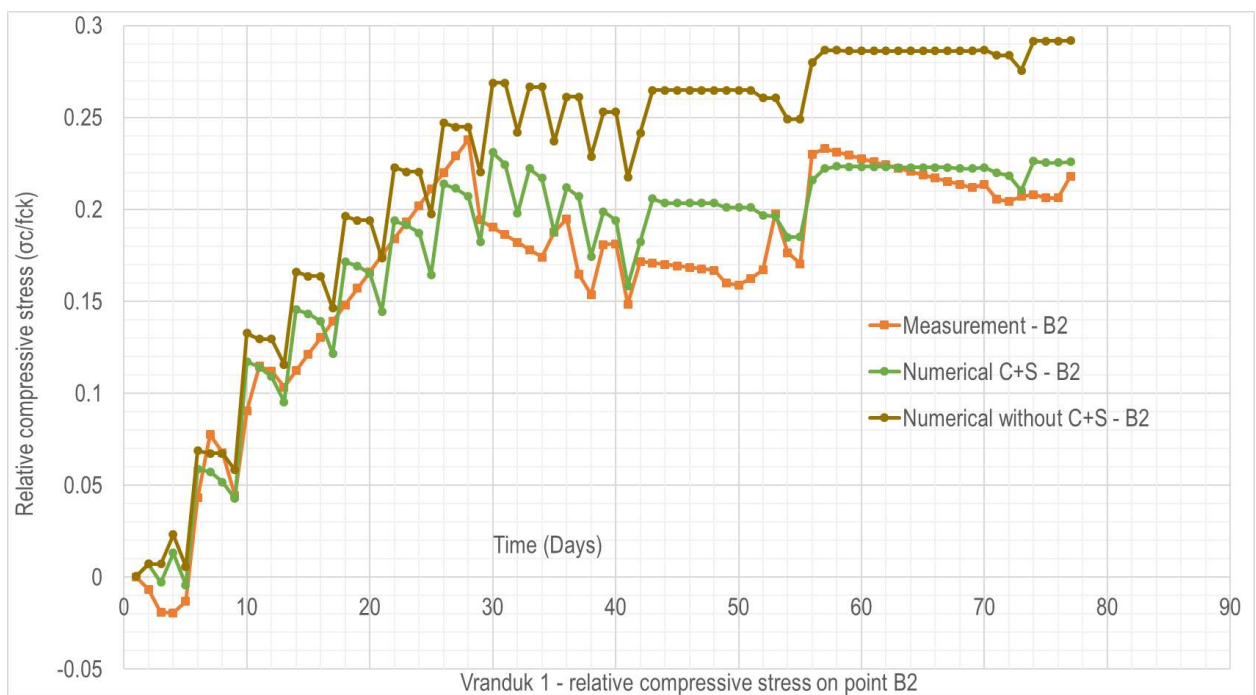


Figure 74. Vranduk 1 – relative compressive stress ( $\sigma_c/f_{ck}$ ) – point B2

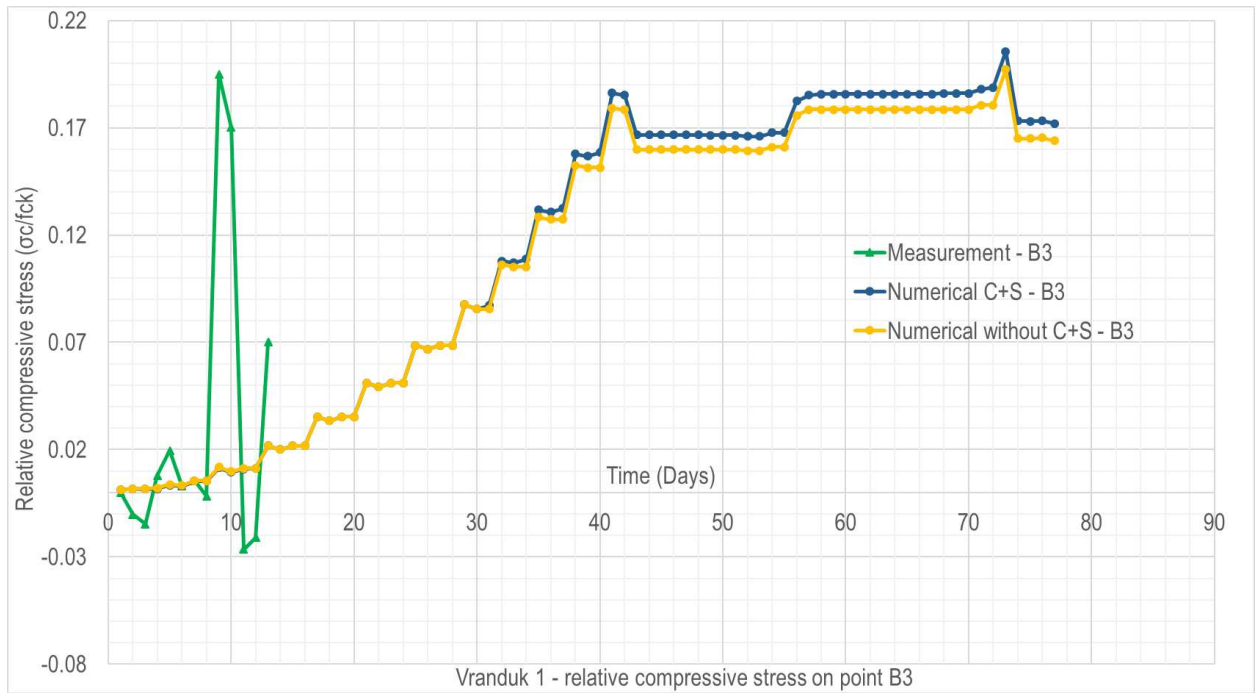


Figure 75. Vranduk 1 – relative compressive stress ( $\sigma_c/f_{ck}$ ) – point B3

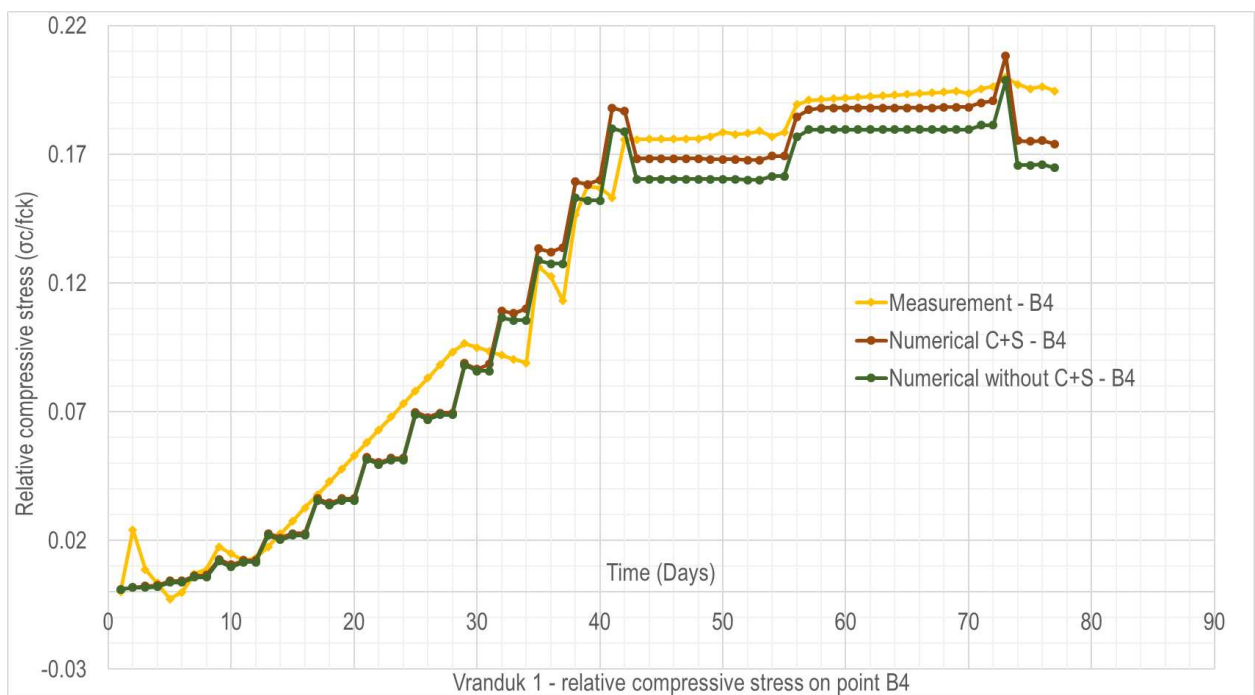


Figure 76. Vranduk 1 – relative compressive stress ( $\sigma_c/f_{ck}$ ) – point B4

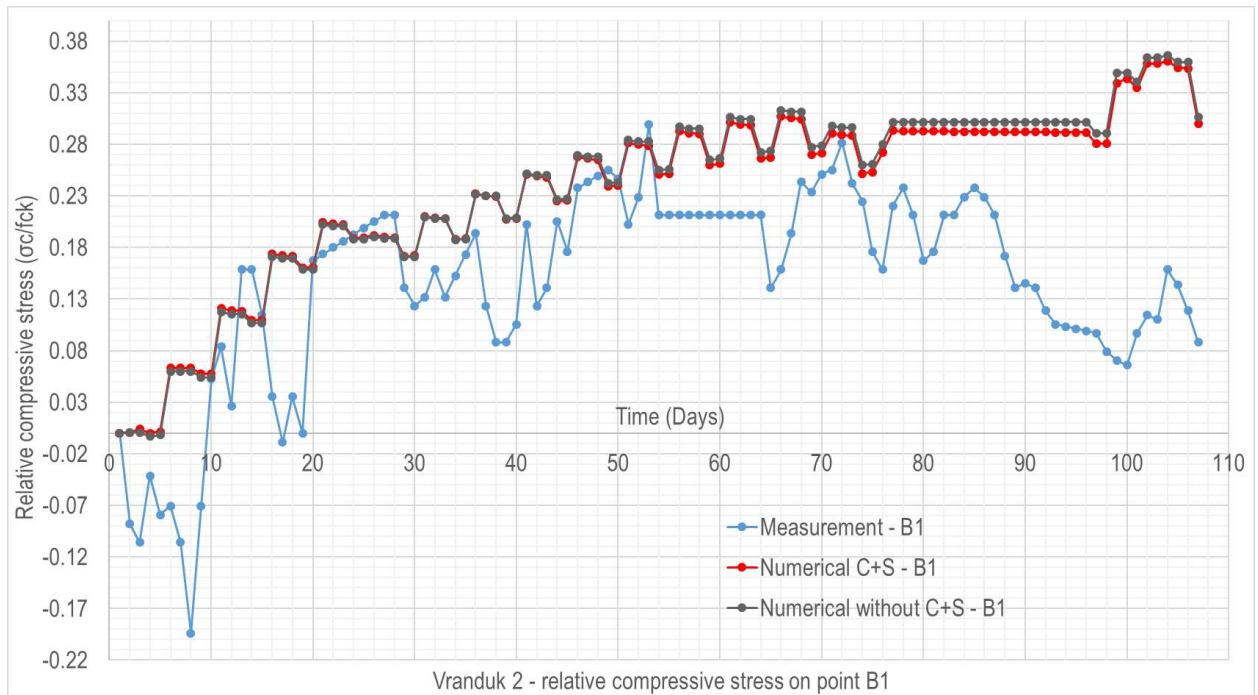


Figure 77. Vranduk 2 – relative compressive stress ( $\sigma_c/f_{ck}$ ) – point B1

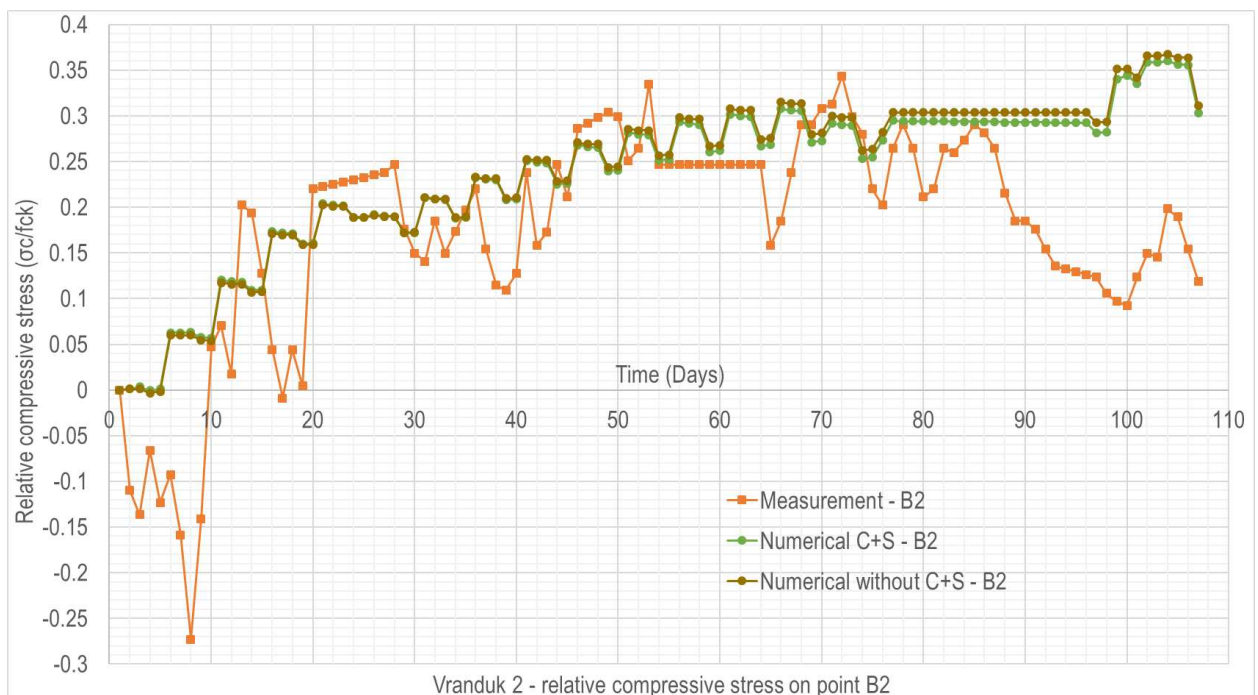


Figure 78. Vranduk 2 – relative compressive stress ( $\sigma_c/f_{ck}$ ) – point B2

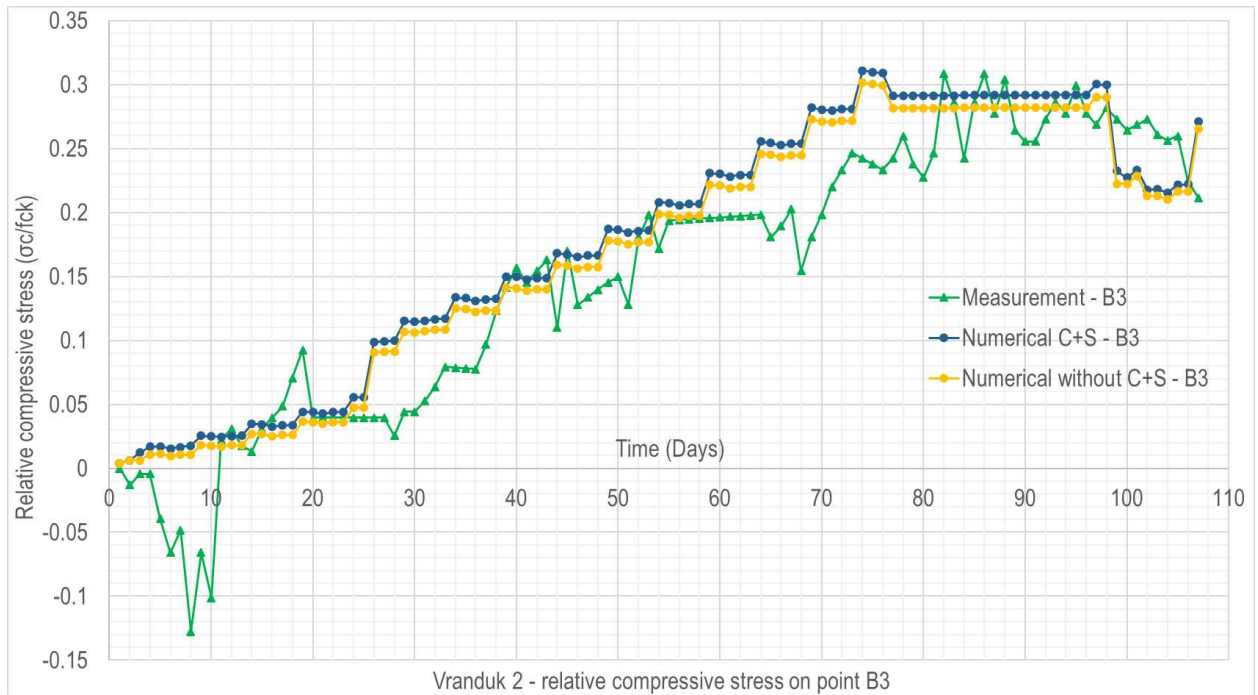


Figure 79. Vranduk 2 – relative compressive stress ( $\sigma_c/f_{ck}$ ) – point B3

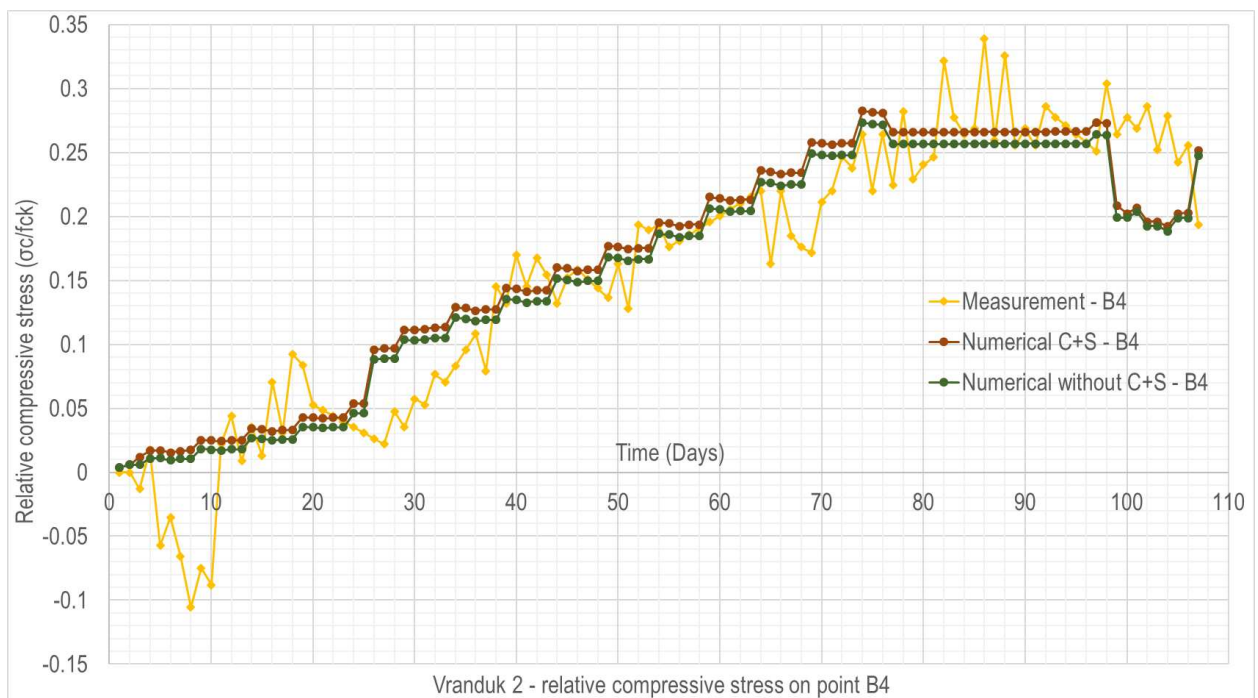


Figure 80. Vranduk 2 – relative compressive stress ( $\sigma_c/f_{ck}$ ) – point B4



### 3. Numerical modelling and result comparison

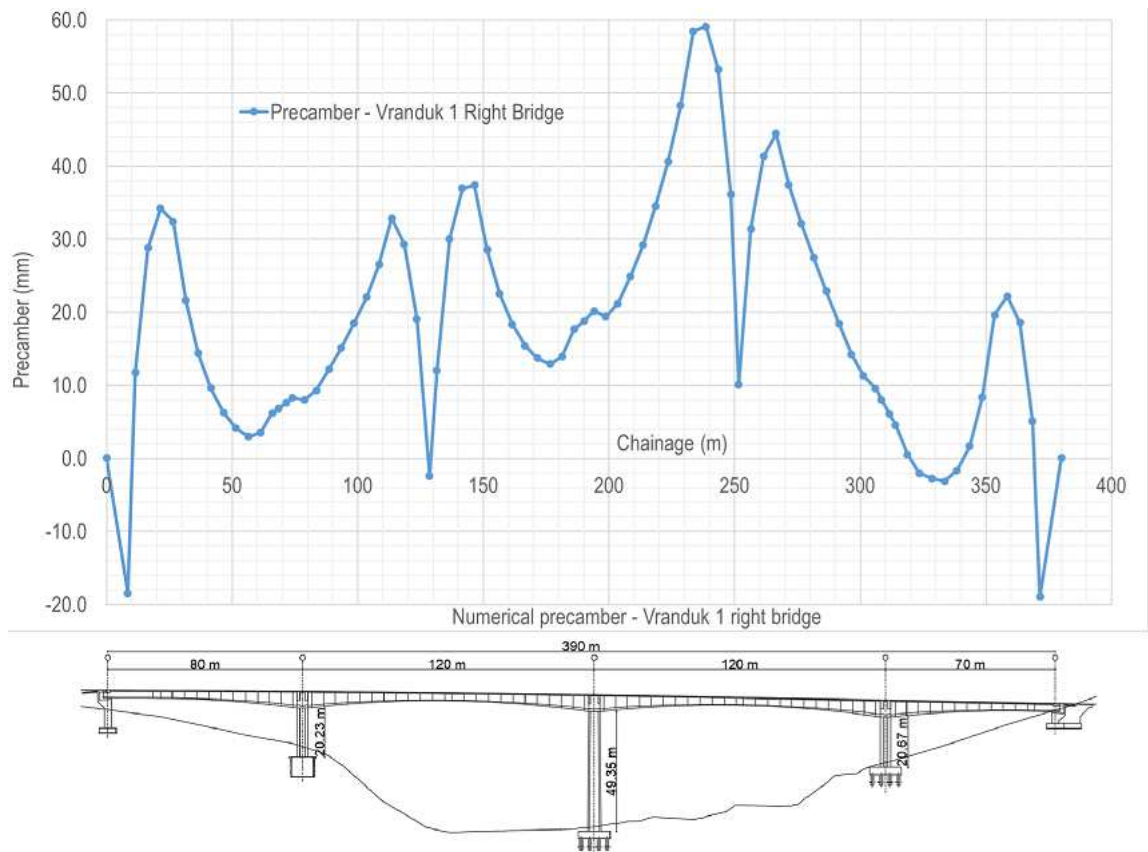


Figure 81. Vranduk 1 – numerical precamber

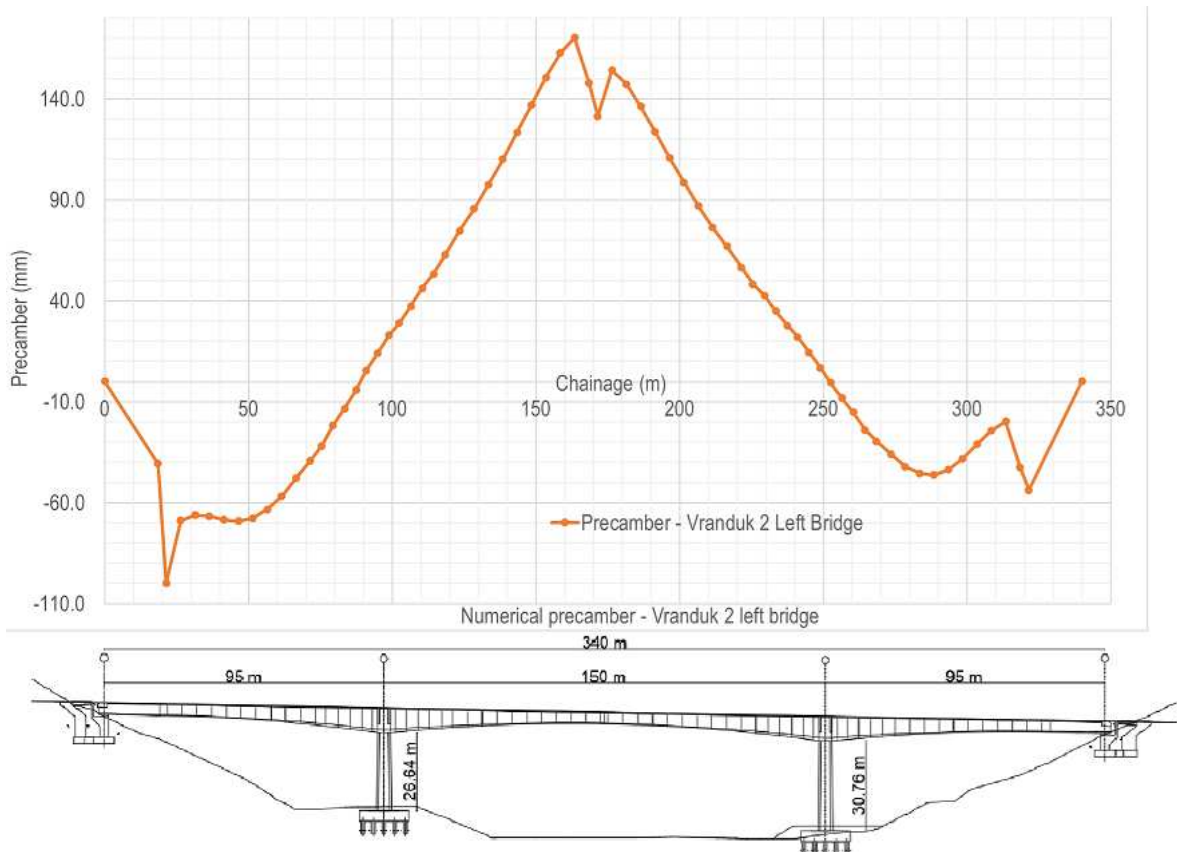


Figure 82. Vranduk 2 – numerical precamber

The monitoring of Vranduk 1 and Vranduk 2 bridges reveals significant compressive forces throughout their cross sections (B1-B4), primarily due to the cantilever construction process and prestressing. Initially, self-weight induces compressive strain in the lower slab and tensile strain in the upper slab. During construction, prestressing of balanced cantilever cables in the upper superstructure notably increases compressive strain in the upper slab, while the lower slab generally experiences minor to no increase in compressive strain.

For Vranduk 1, the monitoring process encountered several gaps, notably between days 13-27, impacting the continuity of measurements. Despite issues with strain gauge installation damage at point B3, reliable strain results were observed elsewhere. Points B1 and B2 on the upper slab exhibited stepped increases in compressive strain, reaching up to 270.25  $\mu\text{m/m}$  (9.5 MPa) on day 28 during the prestressing of segment 7. The final prestressing on day 56 increased compressive strain in the upper slab to around 261.26  $\mu\text{m/m}$  (9.2 MPa), gradually decreasing to 247.67  $\mu\text{m/m}$  (8.5 MPa) by day 77 due to the addition of dead load from concrete barriers.

Regarding Vranduk 2, a more jagged strain diagram was observed due to the absence of temperature compensation. Points B1 and B2 on the upper slab displayed stepped increases in compressive strain, peaking at 390  $\mu\text{m/m}$  (13.7 MPa) on day 72, with the final segment reaching 330  $\mu\text{m/m}$  (11.6 MPa) on day 78. Lower slab prestressing between days 102-104 led to compressive strain increases, reaching up to 225  $\mu\text{m/m}$  (7.9 MPa) at B2.

In terms of stress relative to concrete strength, Vranduk 1's upper slab reached a maximum of 0.238 (9.52 MPa) relative compressive stress, while the lower slab reached 0.20 (8 MPa). Conversely, Vranduk 2 exhibited higher stresses, with the upper slab reaching 0.343 (13.72 MPa) and the lower slab 0.339 (13.56 MPa).

Numerical models were employed to predict the necessary precamber of both structures to maintain proper geometry over their lifespan. Vranduk 1 required a maximum precamber of 59.50 mm, indicating less deformation expected post-construction compared to Vranduk 2, which required 170 mm due to structural differences and longer span. These findings highlight the complex interplay of construction stages, prestressing effects, and structural responses in both bridges, crucial for understanding their long-term performance and durability [P4].



### 3.5. Discussion

During the monitoring of Vranduk 1 and Vranduk 2 bridges, frequent power outages occurred across the construction site despite being equipped with uninterrupted power supplies. These outages, lasting longer than the backup duration, caused data acquisition systems to shut down intermittently. Additionally, accidental mechanical damage to extension cables during construction necessitated their replacement. Missing data due to interruptions was interpolated during analysis, compromising some construction stage phases but maintaining overall trends confirmed by numerical models.

Strain values from calculated models closely align with measured data on both bridges, though minor differences exist. The jagged parts in stress diagrams from measurements are attributed to varying construction processes and loads not fully accounted for in numerical simulations, such as personnel and equipment on-site. The hybrid numerical model used is a compromise between line and area elements to manage complexity; more accurate results would require 3D brick elements, demanding extensive computational resources due to the detailed calculation requirements of balanced cantilever bridges.

Material properties assumed uniform in numerical models contrast with actual variations across segments during installation, impacting accuracy. Accidental construction loads and non-linear temperature effects, especially evident on Vranduk 2 where uncompensated temperature strains caused notable deviations in strain measurements, up to  $300 \mu\text{m/m}$  (10.57 MPa) with a 30 K temperature change.

Comparisons between numerical and measured values indicate that numerical models incorporating creep and shrinkage align well with actual behavior observed on both bridges. On Vranduk 1, differences of about  $50 \mu\text{m/m}$  (1.76 MPa) during certain periods are attributed to unaccounted loads, with closer agreement post-correction. Results excluding creep and shrinkage initially match closely but diverge by up to  $70 \mu\text{m/m}$  (2.65 MPa) over 77 days, reflecting the expected influence of creep and shrinkage in reducing upper slab compressive stress.

Point B3 on Vranduk 1 experienced signal loss on day 13, likely due to accidental cable damage, influencing results. Numerical models, however, show how creep and shrinkage increase compressive strain in the lower slab. Point B4 exhibits good correlation with measured strains when considering creep and shrinkage effects.

For Vranduk 2, discrepancies at points B1 and B2 are primarily due to temperature compensation issues in measurements, affecting strain accuracy. Numerical results indicate creep and shrinkage reduce upper slab compressive strain. Points B3 and B4 demonstrate better agreement between numerical and measured results, despite temperature compensation issues, with average local differences attributed to creep and shrinkage effects.

In conclusion, while numerical models provide detailed insights into bridge behaviour across construction stages, the measured data remains crucial for validating and refining these models with on-site information, particularly in accounting for real-world complexities and environmental factors impacting structural performance [P4].

## **4. CONCLUSION AND DIRECTIONS FOR FURTHER RESEARCH**

### **4.1. Conclusion**

The study compares the behaviour of two balanced cantilever bridges, Vranduk 1 (120m span) and Vranduk 2 (150m span), highlighting significant differences in compressive strains due to their varying spans and superstructure characteristics. Vranduk 2 exhibits higher compressive strains in both upper and lower slabs compared to Vranduk 1, attributed to its longer span and more robust superstructure.

Creep and shrinkage affect deflections in balanced cantilever bridges, particularly at stitch segments where segments merge to achieve proper road geometry alignment. The research underscores the impact of creep and shrinkage on strain during construction phases.

On Vranduk 1, the maximum difference in upper slab strain is  $70 \mu\text{m/m}$  (2.65 MPa), approximately 28% of the maximum compression strain, whereas Vranduk 2 shows a maximum local difference of  $245.47 \mu\text{m/m}$  (8.64 MPa), roughly 63% of the maximum compression strain. Excluding maximum values, creep and shrinkage account for differences of around  $11 \mu\text{m/m}$  (0.40 MPa) on Vranduk 1 and 2.94% on Vranduk 2, likely due to stress fluctuations between box cross section slabs and webs.

Temperature compensation proves crucial for accurate strain and stress monitoring over extended periods, with Vranduk 1 showing better correlation between measured and numerical results due to compensation. Overall, measured and numerical results align well, confirming expected bridge behaviour throughout construction stages, including stitch segment and monolithization. Updating and adjusting the numerical models with observed on-site data yields better results, and better simulates the real behaviour of the structure.

Relative compressive stress analysis indicates Vranduk 2 experiences higher stress levels relative to characteristic concrete strength compared to Vranduk 1. Precamber calculations reveal Vranduk 1 requires significantly less precamber, suggesting simpler construction and maintenance with lower stress levels and self-weight.

In conclusion, the study recommends designing 120m span bridges under favourable site conditions and lower piers. These bridges generally exhibit lower strain and stress levels, reduced self-weight, and simpler construction processes. This approach minimizes construction uncertainties and enhances feasibility.

In summary, the dissertation enriches bridge engineering knowledge by examining strain analysis in cast-in-place balanced cantilever prestressed concrete bridges. It offers practical insights for engineers and researchers, contributing to optimized bridge designs that are structurally sound and efficient.

#### **4.2. Directions for further research**

This dissertation focuses on the construction of prestressed concrete bridges using the balanced cantilever method on site. Future research should expand to include other cast-in-place post-tensioned concrete bridges constructed with varying spans and superstructures (such as wide superstructures, boxes with multiple webs, and boxes with slanted webs). It is recommended to install measurement equipment in multiple cross-sections, with at least 8 measuring points per cross-section, including one at the midpoint.

Analyzing, comparing and adjusting the numerical models with specific information during construction will offer a thorough understanding of the structural behavior across various aspects of these bridges. This approach will provide insights into construction techniques, structural performance, and the influence of different bridge configurations on strain and stress distributions.

## 5. LITERATURE

- [1] Mathivat, J. The cantilever construction of prestressed concrete bridges; Editions Eyrolles: 61, boulevard Saint-Germain, 75005 Paris, France, 1979
- [2] Group of authors Design guide – Prestressed concrete bridges built using the cantilever method; Setra, 2003
- [3] DuBois, A. J. The mechanics of engineering; John Wiley & Sons, 1902
- [4] Bender, C. Discussion on Cantilever Bridges by C.F. Findlay; Canadian Society of Civil Engineers, 1890
- [5] DeLony, E. Context for world heritage bridges; International Council on Monuments and Sites, 1996
- [6] Schneider, C. C. Quebec bridge inquiry report; S. E. Dawson, 1908
- [7] Middleton, W. D. The bridge at Quebec; Indiana University Press, 2001
- [8] Pilz, M. The Collapse of the K-B Bridge in 1996; London, 1997
- [9] Pilz, M., L. G. Continuity in Prestressed Concrete Structures, Time-Dependent Responses; 22nd Conference on Our World in Concrete & Structures, Singapore, 1997
- [10] Pilz, M. The Koror-Babeldaob Bridge in the Republic of Palau, History and Time Dependent Stress and Deflection Analysis; Dissertation Imperial College London, Department of Civil Engineering, 1997
- [11] Skrinar, M.; Strukelj, A. Eigen frequency monitoring during bridge erection. SEI 1996, 6(3), 191-194.
- [12] Strommen, E.; Hjort-Hansen, E.; Kaspersen, J. H. Dynamic loading effects of a rectangular box girder bridge. J. Wind. Eng. Ind. Aerodyn. 2001, 89(14–15), 1607–1618.
- [13] Schmidt, S.; Solari, G. 3-D wind-induced effects on bridges during balanced cantilever erection stages. Wind Struct. 2003, 6(1), 1–22.
- [14] Morassi, A.; Tonon S. Dynamic testing for structural identification of a bridge. J. Bridge Eng. 2008, 13, 573–585.
- [15] Gentile, C.; Bernardini, G. Output-only modal identification of a reinforced concrete bridge from radar-based measurements. Nondestruct. Test. Evaluation 2008, 41, 544–553.
- [16] Bayraktar, A.; Altuŝniŝık, A. C.; Sevim, B.; Domaniç, A.; Taŝ, Y. Vibration characteristics of K m rhan highway bridge constructed with balanced cantilever method. J. Perform. Constr. Facil. 2009, 23(2), 90–99.

- [17] Liu, C.; DeWolf, J. T.; Kim J. Development of a baseline for structural health monitoring for a curved post-tensioned concrete box girder bridge. *Eng. Struct.* 2009, 31, 3107–3115.
- [18] Stathopoulos, S.; Seifried, G.; Kotsanopoulos, P.; Haug, H.; Spyropoulos, I.; Stathopoulos, K. The Metsovo bridge, Greece. *SEI* 2010, 20(1), 49–53.
- [19] Altuşnişik, A. C.; Bayraktar, A.; Sevim, B.; Ates, S. Ambient vibration based seismic evaluation of isolated Gülburnu Highway Bridge. *Soil Dyn. Earthq. Eng.* 2010, 31(11), 1496–1510.
- [20] Turan, F. N. Determination of dynamic characteristics of balanced cantilever reinforced concrete bridges using ambient vibration data; MSc Thesis, Karadeniz Technical University, Trabzon, Türkiye (in Turkish), 2012
- [21] Kudu, F. N.; Bayraktar, A.; Bakir, P. G.; Türker, T.; Altuşnişik, A. C. Ambient vibration testing of Berta Highway Bridge with post-tension tendons. *Steel Compos.* 2014, 16(1), 23–46.
- [22] Sumerkan, S.; Bayraktar, A.; Türker, T.; Akkose, M. A simplified frequency formula for post-tensioned balanced cantilever bridges. *Asian J. Civ. Eng.* 2019, 20, 983–997.
- [23] Bayraktar, A.; Kudu, F. N.; Sumerkan, S.; Demirtas, B., Akkose, M. Near-fault vertical ground motion effects on the response of balanced cantilever bridges. *Proc. Inst. Civ.* 2020, 173, 17-33.
- [24] Casas, J. R. Reliability-based partial safety factors in cantilever construction of concrete bridges. *J. Struct. Eng.* 1997, 123(3), 305-312.
- [25] Manjure, P. J. Rehabilitation of balanced cantilever bridges. *Indian Concr. J.* 2001, 75(1), 76-82.
- [26] Vonganan, B. The second Mekong international bridge, Thailand. *SEI* 2009, 19(1), 67–68.
- [27] Pimanmas, A.; Imsombat, S.; Neilsen, K. Hj. New Phra- Nangklao bridge—A balanced cantilever prestressed concrete bridge in Thailand. *SEI* 2009, 19(1), 38–40.
- [28] Ates, S.; Atmaca, B.; Yildirim, E.; Demiroz, N. A. Effects of soil-structure interaction on construction stage analysis of highway bridges. *Comput. Concr.* 2013, 12(2), 169–186.
- [29] Chen, X.; Omenzetter, P.; Beskhyroun, S. Dynamic testing and long term monitoring of a twelve span viaduct. *Key Eng. Mater.* 2013, 569–570, 342–349.
- [30] Pimentel, M.; Figueiras, J. Assessment of an existing fully prestressed box-girder bridge. *Proc. Inst. Civ.* 2017, 170(1), 42–53.



- [31] Caner, A.; Apaydin, N.; Cinar, M.; Peker, E., Kilic, M. Reconstruction of Partially Collapsed Post-tensioned Begendik Bridge During Balanced Cantilever Construction. *Developments in International Bridge Engineering 2021*, 17-33.
- [32] Kwak, H. G.; Son, J. K. Span ratios in bridges constructed using a balanced cantilever method. *Constr Build Mater.* 2004, 18(10), 767–779.
- [33] Kwak, H. G.; Son, J. K. Design moment variations in bridges constructed using a balanced cantilever method. *Constr Build Mater.* 2004, 18(10), 753-766.
- [34] Hewson, N. Balanced cantilever bridges. *Concrete (London)* 2007, 41(10), 59-60.
- [35] Marzouk, M.; Said, H.; El-Said, M. Special-purpose simulation model for balanced cantilever bridges. *J. Bridge Eng.* 2008, 13(2), 122–131.
- [36] Ates, S. Numerical modelling of continuous concrete box girder bridges considering construction stages. *Appl. Math. Model.* 2011, 35(8), 3809–3820.
- [37] Bravo, J.; Benjumea, J.; Consuegra, F. A. Parametric Study to Estimate Seismic Displacement Demands of Balanced Cantilever Bridges in Service and Construction Conditions; Conference: fib Symposium 2021 - Concrete Structures: New Trends for Eco-Efficiency and Performance, 2021
- [38] Pimanmas, A. The effect of long-term creep and prestressing on moment redistribution of balanced cantilever cast-in-place segmental bridge. *SJST* 2007, 29(1), 205–216.
- [39] Hedjazi, S.; Rahai, A.; Sennah, K. Evaluation of creep effects on the time-dependent deflections and stresses in prestressed concrete bridges. *Bridge Structures* 2007, 3(2), 119-132.
- [40] Altuŝniŝık, A. C.; Bayraktar, A.; Sevim, B.; Adanur, S.; Domaniç, A. Construction stage analysis of K m rhan highway bridge using time dependent material properties. *Struct. Eng. Mech.* 2010, 36(2), 207–223.
- [41] Malm, R.; Sundquist, H. Time-dependent analyses of segmentally constructed balanced cantilever bridges. *Eng Struct.* 2010, 32(4), 1038–1045.
- [42] Akbar, S.; Carlie, M. Long-term deformation of balanced cantilever bridges due to non-uniform creep and shrinkage; KTH Royal Institute of Technology, School of Architecture and the Built Environment, 2021
- [43] McDonald, B.; Saraf, V.; Ross, B. A spectacular collapse: Koror-Babeldaob (Palau) balanced cantilever prestressed, posttensioned bridge. *Indian Concr. J.* 2003, 77(3), 955–962.

- [44] Radić, J.; Gukov, I.; Meštrović, D. A new approach to deflection analysis of cantilever beam bridges. in Proc of the 2nd International Conference IABMAS – Bridge Maintenance, Safety, Management and Cost. Ed. by Watanabe, E.; Frangopol, D. M.; Utsunomiya, T. 18–22 Oct, Kyoto, Japan. Leiden: A. A. Balkema Publishers. 8 p. ISBN 04 1536 336 X, 2004
- [45] Jung, S.; Ghaboussi, J.; Marulanda, C. Field calibration of time-dependent behavior in segmental bridges using self-learning simulation. *Eng. Struct.* 2007, 29(10), 2692–2700.
- [46] Kronenberg, J. Continuous concrete placing during balanced cantilever construction of a bridge. *Concr. Eng. Int.* 2008, 12(3), 38–39.
- [47] Kamaitis, Z. Field investigation of joints in precast post-tensioned segmental concrete bridges. *Balt. J. Road Bridge Eng.* 2008, 3(4), 198–205.
- [48] Starossek, U. Shin Chon Bridge Korea. *SEI* 2009, 19(1), 79-84.
- [49] Furunes, E. W. Trysfjord bridge, parametric analysis and modelling for drawingless construction of a concrete balanced cantilever bridge; IABSE Congress: Structural Engineering for Future Societal Needs, Ghent, Belgium, 1999-2004, 2021
- [50] Integra Ltd. Mostar Preparation of main design and related studies for motorway section in the Corridor Vc, Group F – Structures (Engineering Structures), Book: F 2100 – Civil design of the Vranduk 1 bridge, textual part and drawings, 2018
- [51] Integra Ltd. Mostar Preparation of main design and related studies for motorway section in the Corridor Vc, Group F – Structures (Engineering Structures), Book: F 2200 – Civil design of the Vranduk 2 bridge, textual part and drawings, 2018
- [52] EN 1992-1-1:2004+AC:2010: Eurocode 2: Design of concrete structures – Part 1-1: General rules and rules for buildings, 2004
- [53] CEB-FIP MODEL CODE 1990, Thomas Telford Ltd., London, 1993

- [P1] Jurišić, M.; Cvitković, M. STUDENČICA BRIDGE TESTING. *Electronic Journal of the Faculty of Civil Engineering Osijek-e-GFOS*, 2016, 7(12), 1-9. <https://doi.org/10.13167/2016.12.1>
- [P2] Harapin, A.; Jurišić, M.; Bebek, N.; Sunara, M. Long-Term Effects in Structures: Background and Recent Developments. *Appl. Sci.* 2024, 14, 2352. <https://doi.org/10.3390/app14062352>
- [P3] Jurišić, M.; Bebek, N.; Čubela, D.; Harapin, A. Balanced cantilever construction method in post-tensioned concrete bridges. *Structural Engineering International*, <https://doi.org/10.1080/10168664.2024.2356559> (accepted for publication 15.05.2024.)
- [P4] Jurišić, M.; Bebek, N.; Čubela, D.; Harapin, A. Strain Analysis on Cast-In-Place Balanced Cantilever Prestressed Concrete Bridges During Construction. *Structural Engineering International*, 2024, 1–11. <https://doi.org/10.1080/10168664.2023.2296979>

## 6. LIST OF FIGURES

Figure 1. Classic design of bridges with balanced cantilever construction .....	2
Figure 2. Principle of a Gallic wooden bridge .....	3
Figure 3. Thomas Pope – proposed timber bridge .....	4
Figure 4. Gerber hinge principle .....	5
Figure 5. Hassfurt Bridge .....	5
Figure 6. Forth bridge, Scotland.....	6
Figure 7. Demonstration of the Forth bridge statical principle .....	6
Figure 8. Plougastel Bridge.....	7
Figure 9. Herval Bridge.....	7
Figure 10. Donzere Bridge .....	8
Figure 11. Caracas Viaduct .....	8
Figure 12. La Voulte railway bridge .....	9
Figure 13. Chazey bridge .....	10
Figure 14. Vallon du Moulin a Poudre Bridge.....	10
Figure 15. Choisy-le-Roi Bridge.....	11
Figure 16. Shibampo Bridge .....	12
Figure 17. (a) Scheme of a balanced cantilever construction process on a prestressed concrete bridge; (b) Balanced cantilever construction method on a prestressed concrete bridge during construction .....	13
Figure 18. Feasibility of different bridge types by span length (m) – (black – feasible, dark grey – possible and possibly feasible, light grey – possible but not feasible).....	14
Figure 19. Quebec bridge, collapse of the central segment .....	16
Figure 20. (a) Koror-Babeldaob bridge after construction; (b) Koror-Babeldaob bridge after collapse.....	17
Figure 21. Koror-Babeldaob bridge damage overview .....	18
Figure 22. Carinthia Bridge in Maribor .....	19
Figure 23. Capriate Bridge .....	20
Figure 24. Komurhan Bridge .....	20
Figure 25. Metsovo Bridge.....	21
Figure 26. Berta Bridge.....	22
Figure 27. Mekong Bridge .....	23
Figure 28. Phra-Nangklao Bridge .....	23

Figure 29. Begendik Bridge .....	24
Figure 30. Pathum Thani Bridge elevation .....	25
Figure 31. Navile Bridge .....	26
Figure 32. Hacka Bridge .....	27
Figure 33. Trysfjord Bridge .....	27
Figure 34. Vranduk 1 left and right bridge.....	35
Figure 35. Vranduk 1 right bridge longitudinal section .....	36
Figure 36. Vranduk 1 bridge characteristic cross section .....	36
Figure 37. Vranduk 2 bridge under construction .....	37
Figure 38. Vranduk 2 left bridge longitudinal section .....	38
Figure 39. Vranduk 2 bridge characteristic cross section .....	38
Figure 40. Strain gauge with the adapter.....	40
Figure 41. QuantumX 840A data acquisition system .....	41
Figure 42. Vranduk 2 longitudinal strain gauge section position .....	41
Figure 43. Vranduk 2 strain gauge position in the cross section.....	42
Figure 44. Vranduk 1 longitudinal strain gauge section position .....	42
Figure 45. Vranduk 1 strain gauge position in the cross section.....	42
Figure 46. Strain gauge on a concrete sample used for temperature compensation .....	43
Figure 47. Strain gauge on a prestressing steel sample used for temperature compensation .....	43
Figure 48. Surface prepared for gauge installation .....	44
Figure 49. Installed gauge with the adapter after glue hardening .....	44
Figure 50. Strain gauge after protection.....	45
Figure 51. Strain gauge installation on prestressing cables (with temperature compensation) ...	45
Figure 52. Box containing data acquisition equipment.....	45
Figure 53. Vranduk 1 bridge model .....	48
Figure 54. Vranduk 2 bridge model .....	48
Figure 55. Vranduk 1 bridge horizontal axis allignement.....	49
Figure 56. Example of generated cross sections: pier (left) and superstructure (right) .....	49
Figure 57. Vranduk 1 S1 pier .....	51
Figure 58. Vranduk 2 S1 pier .....	51
Figure 59. Vranduk 1 prestressing cables .....	52
Figure 60. Vranduk 2 prestressing cables .....	52
Figure 61. Vranduk 1 construction stage .....	53
Figure 62. Vranduk 2 construction stage .....	53

Figure 63. Stress-strain concrete diagram used for the numerical model (green curve).....	54
Figure 64. Example of a single day strain-time diagram change .....	55
Figure 65. Vranduk 1 – measured and numerical strain with and without creep and shrinkage (C+S) – point B1 .....	56
Figure 66. Vranduk 1 – measured and numerical strain with and without creep and shrinkage (C+S) – point B2 .....	56
Figure 67. Vranduk 1 – measured and numerical strain with and without creep and shrinkage (C+S) – point B3 .....	57
Figure 68. Vranduk 1 – measured and numerical strain with and without creep and shrinkage (C+S) – point B4 .....	57
Figure 69. Vranduk 2 – measured and numerical strain with and without creep and shrinkage (C+S) – point B1 .....	58
Figure 70. Vranduk 2 – measured and numerical strain with and without creep and shrinkage (C+S) – point B2 .....	58
Figure 71. Vranduk 2 – measured and numerical strain with and without creep and shrinkage (C+S) – point B3 .....	59
Figure 72. Vranduk 2 – measured and numerical strain with and without creep and shrinkage (C+S) – point B4 .....	59
Figure 73. Vranduk 1 – relative compressive stress ( $\sigma_c/f_{ck}$ ) – point B1.....	60
Figure 74. Vranduk 1 – relative compressive stress ( $\sigma_c/f_{ck}$ ) – point B2.....	60
Figure 75. Vranduk 1 – relative compressive stress ( $\sigma_c/f_{ck}$ ) – point B3.....	61
Figure 76. Vranduk 1 – relative compressive stress ( $\sigma_c/f_{ck}$ ) – point B4.....	61
Figure 77. Vranduk 2 – relative compressive stress ( $\sigma_c/f_{ck}$ ) – point B1.....	62
Figure 78. Vranduk 2 – relative compressive stress ( $\sigma_c/f_{ck}$ ) – point B2.....	62
Figure 79. Vranduk 2 – relative compressive stress ( $\sigma_c/f_{ck}$ ) – point B3.....	63
Figure 80. Vranduk 2 – relative compressive stress ( $\sigma_c/f_{ck}$ ) – point B4.....	63
Figure 81. Vranduk 1 – numerical precamber.....	64
Figure 82. Vranduk 2 – numerical precamber.....	64



# PAPER I

# PAPER II

# PAPER III

# PAPER IV