

The impact of usability factors on continuance intention to use the system for acquisition and evaluation of digital competences in the domain of education

Sobodić, Aleksandra

Doctoral thesis / Disertacija

2021

Degree Grantor / Ustanova koja je dodijelila akademski / stručni stupanj: **University of Zagreb, Faculty of Organization and Informatics / Sveučilište u Zagrebu, Fakultet organizacije i informatike**

Permanent link / Trajna poveznica: <https://um.nsk.hr/um:nbn:hr:211:128179>

Rights / Prava: [In copyright](#) / [Zaštićeno autorskim pravom.](#)

Download date / Datum preuzimanja: **2024-07-16**



Repository / Repozitorij:

[Faculty of Organization and Informatics - Digital Repository](#)





University of Zagreb

Faculty of Organization and Informatics

Aleksandra Sobodić

**The impact of usability factors on
continuance intention to use the system
for acquisition and evaluation of digital
competences in the domain of education**

DOCTORAL DISSERTATION

Varaždin, 2021.



University of Zagreb

Faculty of Organization and Informatics

Aleksandra Sobodić

**The impact of usability factors on
continuance intention to use the system
for acquisition and evaluation of digital
competences in the domain of education**

DOCTORAL DISSERTATION

Supervisors:

Assoc. Prof. Igor Balaban, Ph.D.

Full Prof. Andrina Granić, Ph.D.

Varaždin, 2021.



Sveučilište u Zagrebu

Fakultet organizacije i informatike

Aleksandra Sobodić

**Utjecaj čimbenika upotrebljivosti na
namjeru ponovnog korištenja sustava za
stjecanje i vrjednovanje digitalnih
kompetencija u domeni obrazovanja**

DOKTORSKA DISERTACIJA

Mentori:

Izv. prof. dr. sc. Igor Balaban

Prof. dr. sc. Andrina Granić

Varaždin, 2021.

DOCTORAL THESIS INFORMATION

I. AUTHOR

Name and surname	Aleksandra Sobodić
Date and place of birth	5 September 1990, Pula, Croatia
Faculty name and graduation date for level VII/I	Faculty of Organization and Informatics, 2 October 2012
Faculty name and graduation date for level VII/II	Faculty of Organization and Informatics, 16 July 2014
Current employment	Faculty of Organization and Informatics

II. DOCTORAL THESIS

Title	The impact of usability factors on continuance intention to use the system for acquisition and evaluation of digital competences in the domain of education
Number of pages, figures, tables, appendixes, bibliographic information	165 pages, 20 figures, 32 tables, 4 appendixes, 252 items of bibliographic information
Scientific area and fields in which the title has been awarded	Social Sciences, Information and Communication Sciences
Supervisors	Assoc. Prof. Igor Balaban, Ph.D. Full Prof. Andrina Granić, Ph.D.
Faculty where the thesis was defended	Faculty of Organization and Informatics
Thesis mark and ordinal number	161

III. GRADE AND DEFENCE

Date of doctoral thesis topic acceptance	13 October 2020
Date of doctoral thesis submission	09 June 2021
Date of doctoral thesis positive grade	16 September 2021
Grading committee members	Full Prof. Valentina Kirinić, Ph.D. Assoc. Prof. Dijana Plantak Vukovac, Ph.D. Assoc. Prof. Tihomir Orehovački, Ph.D.
Date of doctoral thesis defence	15 October 2021
Defence committee members	Full Prof. Valentina Kirinić, Ph.D. Assoc. Prof. Dijana Plantak Vukovac, Ph.D. Assoc. Prof. Tihomir Orehovački, Ph.D.
Date of promotion	

Assoc. Prof. Igor Balaban, Ph.D.

Igor Balaban is Associate Professor at FOI, the Head of Laboratory for advanced technologies in e-learning, and the Head of E-learning committee at FOI. He participated in a variety of European and national projects, coordinated several of them (LLP, Erasmus+) and locally coordinated the Horizon 2020 project. He authored and co-authored 50+ scientific and professional papers and cooperates with European Commissions' Joint Research Centre as an external expert for DigCompOrg & DigCompEdu frameworks and the SELFIE tool. He organized and conducted dozens of workshops, talked at more than 30 conferences, and was invited speaker at some of them. He is also a reviewer for several highly respected journals such as Computers & Education, International Journal of ePortfolio and International Journal of Information Systems. His main field of interest is technology-supported learning with a special focus on adaptivity and personalization in learning environments and the digital transformation of educational organizations. He also has a traceable scientific record in assessing the successful implementation of information systems.

He is also a program committee member for the Croatian CARNET User Conference, and Central European Conference on Intelligent and Information Systems (CECIIS). He is a member of the EDEN NAP Steering Committee.

Full Prof. Andrina Granić, Ph.D.

Andrina Granić is Full Professor at the Department of Computer Science, Faculty of Science at the University of Split. She received her Ph.D. and M.Sc. degrees in Computer Science and a Dipl.-Ing. degree in Electrical Engineering, all from the University of Zagreb, Croatia. Her areas of expertise are in Human-Computer Interaction (HCI), Technology Enhanced Learning (TEL) and Technology Acceptance. Dr. Granić has published more than 100 peer-reviewed papers as book chapters or in journals and conference proceedings. She is on the Editorial Board of five journals and has been on the Program/Organization Committee for more than 50 academic conferences. She has been involved or is currently participating in a number of national and international projects. For the past ten years she has reviewed research project proposals for the European Commission. Dr. Granić is the Croatian representative for the International Federation for Information Processing (IFIP) Technical Committee on Human-Computer Interaction and is a member of the IEEE Computer Society.

ACKNOWLEDGMENTS

I am deeply grateful to my first supervisor, Assoc. Prof. Igor Balaban, Ph.D., for his invaluable support and guidance during the postgraduate doctoral study. My sincere appreciation also goes to my second supervisor, Full Prof. Andrina Granić, Ph.D., for her exceptionally helpful comments and suggestions on my work. It was a wonderful experience to be under their supervision and to learn from their expertise.

I am thankful to all partners on the CRISS project, experts and participants who agreed to take part in the research, for their valuable time and efforts.

To my dearest family, thank you for your love, support and constant encouragement.

ABSTRACT

Built on a stream of literature that has identified a limited number of studies that examine the post-adoption behaviour of information system users, and especially, in relation to the usability of systems that support teaching and learning processes, this thesis attempted to address those gaps by applying the sequential mixed-methods design. The usability-extended Expectation-Confirmation Model (ECM) was developed to determine the factors that impact users' continuance intention to use the system for acquisition and evaluation of digital competence (DC). This research context is considered a future integral part of formal competency-based curricula and DC education. The structural equation modelling was used to examine the proposed research model based on a developed survey instrument distributed among primary and secondary school teachers in six European countries. The instrument content validity was ensured through a rigorous literature review process, followed by a judgement stage involving experts and focus groups. Results revealed that the continuance intention to use the system in the usability-extended ECM was directly driven by teachers' levels of satisfaction, perceived usefulness and efficiency, and indirectly through satisfaction by perceived effectiveness. However, the level of teachers' computer skills and duration of system use did not moderate the satisfaction-continuance intention relationship.

Keywords: expectation-confirmation model, usability, information system, post-adoption behaviour, continuance intention, system for acquisition and evaluation of digital competences, primary school, secondary school

SAŽETAK

Pregledom literature utvrđen je ograničen broj radova koji istražuju ponašanje korisnika nakon usvajanja određenog informacijskog sustava, a posebno, u odnosu na upotrebljivost sustava koji podržavaju procese učenja i poučavanja. Ovom disertacijom pokušali su se riješiti identificirani nedostaci sekvencijalnom primjenom mješovitih metoda. Model potvrđenog očekivanja proširen upotrebljivošću razvijen je kako bi se odredili čimbenici koji utječu na namjeru ponovnog korištenja kod korisnika sustava za stjecanje i vrjednovanje digitalnih kompetencija. Navedeni kontekst istraživanja smatra se budućim sastavnim dijelom formalnih kurikuluma i obrazovanja usmjerenih na razvoj digitalnih kompetencija. Modeliranje strukturalnih jednadžbi korišteno je za ispitivanje predloženog istraživačkog modela temeljem razvijenog anketnog instrumenta koji je proveden među nastavnicima osnovnih i srednjih škola u šest europskih država. Valjanost sadržaja instrumenta osigurana je rigoroznim postupkom pregleda literature, nakon čega je uslijedila faza prosudbe stručnjaka i fokus grupa. Rezultati su pokazali da je u Modelu potvrđenog očekivanja proširenom upotrebljivošću, namjera ponovnog korištenja sustava za stjecanje i vrjednovanje digitalnih kompetencija izravno potaknuta razinom zadovoljstva nastavnika, percipiranom korisnošću te učinkovitošću, a neizravno kroz zadovoljstvo percipiranom djelotvornošću. Međutim, razina računalnih vještina nastavnika i trajanje korištenja sustava nisu upravljale odnosom između zadovoljstva i namjere ponovnog korištenja.

Ključne riječi: model potvrđenog očekivanja, upotrebljivost, informacijski sustav, ponašanje nakon prihvaćanja, kontinuirana namjera, sustav za stjecanje i vrjednovanje digitalnih kompetencija, osnovna škola, srednja škola

PROŠIRENI SAŽETAK

U **uvodnom poglavlju** iznesena je motivacija te identificirani nedostaci u literaturi koji su vodili doktorandicu kroz istraživanje. Naime, uočen je ograničeni broj radova koji se bavi ispitivanjem ponašanja korisnika nakon njegovog prihvaćanja određenog informacijskog sustava (IS), a posebno u odnosu na upotrebljivost sustava koji podržavaju procese učenja i poučavanja. Nakon toga, predstavljena je svrha disertacije te istraživačka pitanja koja su konkretizirana kroz hipoteze. Nakon kraćeg opisa istraživačkog konteksta, prikazan je pregled metodologije istraživanja, a potom i očekivani znanstveni doprinosi te postojeća struktura disertacije.

U **drugom poglavlju** predstavljen je Model potvrđenog očekivanja koji nadilazi ograničene mogućnosti ostalih bihevioralnih okvira u objašnjavanju ponašanja korisnika nakon prihvaćanja IS-a. Nakon toga, u disertaciju je uveden i pojam upotrebljivosti čiji je teorijski razvoj kronološki iznesen. Postupkom pregleda literature identificirani su radovi koji primjenjuju jedan ili više konstrukata Modela potvrđenog očekivanja te upotrebljivosti u svom istraživačkom modelu. Na kraju su pronađeni radovi objedinjeni te elaborirani.

U **trećem poglavlju** prikazan je razvoj istraživačkog modela, tj. Modela potvrđenog očekivanja proširen upotrebljivošću, namijenjen ispitivanju namjere korisnika da nastavi koristiti sustav za stjecanje i vrjednovanje digitalnih kompetencija. Upotrebljivost se u samom modelu mjeri percipiranom djelotvornošću, percipiranom učinkovitošću i zadovoljstvom. S obzirom da je mjerenje zadovoljstva dio originalnog Modela potvrđenog očekivanja taj se konstrukt proširio samo u teorijskom smislu. Sveukupno, model uključuje šest konstrukata koji su operacionalizirani kako bi se pristupilo izgradnji mjernog instrumenta, odnosno formuliranju čestica. Temeljem istraživačkog modela postavljene su četiri hipoteze koje pretpostavljaju medijatorske i moderatorske utjecaje između varijabli. Postavljeni model testiran je u kontekstu sustava za stjecanje i vrjednovanje digitalnih kompetencije, u užem smislu CRISS platforme koja je detaljno objašnjena na kraju trećeg poglavlja.

U **četvrtom je poglavlju**, kroz šest istraživačkih slojeva, objašnjen dizajn provedenog istraživanja. U prva dva sloja objašnjeni su filozofija i pristup razvoju teorije u disertaciji. U trećem i četvrtom sloju naveden je način odabira metodologije i strategija prikupljanja podataka. Vremenski raspon razložen je u petom sloju dok se zadnji sloj odnosi na primijenjeni dizajn uzorkovanja, razvoj

instrumenta te, naposljetku, na analizu podataka i prikaz rezultata navedenih u petom poglavlju. Naime, pozitivizam i dedukcija smatrani su odgovarajućom filozofijom, odnosno pristupom provedbi istraživanja s obzirom na svjetonazore doktorandice. Tijekom presječnog istraživanja koristile su se mješovite metode koje su bile primijenjene sekvencijalno kroz četiri faze. Reprezentativni uzorak ispitanika definiran je s obzirom na postavljene kriterije, te mogućnosti doktorandice. Naposljetku, pristupilo se razvoju mjernog instrumenta kroz tri faze. U skladu s relevantnim radovima u prvoj je fazi definirano 46 čestica koje su potom prilagođene kontekstu platforme CRISS. U drugu su fazu uključeni stručnjaci te fokus grupe u aktivnosti procjene važnosti čestica za zadani instrument i za ciljanu grupu ispitanika. Završni anketni instrument sadržavao je 29 čestica koje su metodom “naprijed-natrag” s engleskog prevedene na hrvatski, grčki, talijanski, rumunjski i španjolski. Predtestiranje je provedeno s osam nastavnika osnovnih i srednjih škola u šest europskih zemalja (Hrvatska, Grčka, Španjolska, Italija, Rumunjska i Švedska). Temeljem toga napravljene su manje izmjene u instrumentu, ali je zadržan isti broj čestica koje su podvrgnute cjelovitom ispitivanju. Ispitivanje se provelo putem ankete u kojoj je sudjelovalo sveukupno 353 nastavnika u periodu od 29. travnja do 30. lipnja 2019. godine. Prilikom prikupljanja podataka u obzir je uzeto niz pravnih te etičkih aspekata koji su navedeni te razrađeni.

U **petom poglavlju** provedene su univarijantne i multivarijante statističke analize na prikupljenim primarnim empirijskim podacima. Obilježja uzorka analizirana su metodama opisne statistike pri čemu su interpretirane mjere središnje tendencije, disperzije, asimetrije i zaobljenosti zadanih čestica. S druge strane, metoda parcijalnih najmanjih kvadrata modeliranja strukturnih jednadžbi (PLS-SEM) korištena je za ispitivanje mjernog i strukturnog modela, dok je metoda modeliranja strukturnih jednadžbi temeljena na kovarijanci (CB-SEM) korištena za procjenu slaganja modela s podacima. Nakon što je model pokazao odgovarajuću razinu pouzdanosti, konvergentne i diskriminantne valjanosti, te dobro slaganje s izmjerenim podacima, pristupilo se mjerenju strukturnog modela te povezanosti između varijabli. Rezultati su pokazali da je kontinuirana namjera prema platformi CRISS izravno potaknuta razinom zadovoljstva nastavnika, percipiranom korisnošću i percipiranom učinkovitošću, a neizravno kroz zadovoljstvo percipiranom djelotvornošću. Međutim, razina računalne vještine nastavnika i vrijeme korištenja platforme CRISS nisu moderirali odnos između zadovoljstva i kontinuirane namjere.

U **šestom se poglavlju** raspravlja o dobivenim rezultatima s obzirom na svrhu disertacije, istraživačka pitanja i postavljene hipoteze. U **sedmom su poglavlju** navedeni zaključci u smislu teorijskih i praktičnih doprinosa disertacije, te su iznesena ograničenja i prijedlozi za buduća istraživanja.

TABLE OF CONTENTS

ACKNOWLEDGMENTS	I
ABSTRACT	II
SAŽETAK	III
PROŠIRENI SAŽETAK	IV
1 INTRODUCTION	1
1.1 Motivation and Research Problem	1
1.2 Research Objectives and Hypotheses	5
1.3 Research Context	6
1.4 Research Methodology	6
1.5 Expected Scientific Contributions	7
1.6 Thesis Outline	8
2 LITERATURE REVIEW	9
2.1 Expectation-Confirmation Model (ECM)	9
2.2 Usability	14
2.3 State of the Art on Usability in ECM	20
2.3.1 Literature Review Process	20
2.3.2 Synthesis of Findings	22
3 RESEARCH MODEL AND HYPOTHESES	29
3.1 Construction of Research Model	29
3.2 Hypotheses Development	31
3.3 Research Context	34
4 RESEARCH METHODOLOGY	39
4.1 Research Design	39
4.1.1 Research Philosophy and Approach	40
4.1.2 Methodological Choice and Strategy	41
4.1.3 Time Horizon	42
4.2 Sampling Design	43
4.3 Instrument Development	44
4.3.1 Item Creation	44
4.3.2 Scale Development	45
4.3.3 Instrument Testing	54
4.4 Legal and Ethical Considerations	57

5	DATA ANALYSIS AND RESULTS	59
5.1	Characteristics of Respondents	60
5.2	Descriptive Statistics	63
5.3	Measurement Model Assessment	66
5.3.1	Reliability and Convergent Validity	67
5.3.2	Discriminant Validity	69
5.4	Data-Model Fit Assessment	72
5.5	Structural Model Assessment	79
5.5.1	Path Analysis	83
5.5.2	Mediator and Moderator Analysis	85
6	DISCUSSION OF RESULTS	93
6.1	Findings in Relation to the Aim and Research Question	95
6.2	Findings in Relation to the Hypotheses	98
7	CONCLUSION.....	101
7.1	Contribution	101
7.1.1	Theoretical Contribution	101
7.1.2	Practical Contribution	102
7.2	Limitations and Future Research.....	103
	REFERENCES	105
	APPENDICES	132
	Appendix A: Initial Set of Items.....	132
	Appendix B: Judgements of Experts (CVR)	135
	Appendix C: Survey in Croatian	137
	Appendix D: Survey in English.....	142
	CURRICULUM VITAE.....	147

LIST OF TABLES

Table 1. Thesis outline	8
Table 2. Summary of literature review	23
Table 3. The summary of key findings.....	26
Table 4. Operational definitions of constructs.....	31
Table 5. Experts' data.....	46
Table 6. A final set of items after experts' judgments	47
Table 7. Summary of focus groups.....	50
Table 8. Focus groups – participant structure.....	51
Table 9. Set of items after focus groups (Final instrument).....	51
Table 10. Sociodemographic characteristics of respondents (N=353).....	61
Table 11. Behavioural characteristics of respondents (N=353)	62
Table 12. Descriptive statistics for each construct.....	63
Table 13. Descriptive statistics for each item (N=353)	65
Table 14. Measurement model.....	68
Table 15. Cross-loadings	70
Table 16. Fornell-Larcker Criterion	71
Table 17. Heterotrait-monotrait (HTMT) ratio of correlations	71
Table 18. Goodness-of-fit indices (Brown, 2015; Perry et al., 2015; Segars & Grover, 1998)	72
Table 19. Fit indices and modifications for Perceived effectiveness (PFE)	74
Table 20. Fit indices and modifications for Perceived efficiency (PFI)	75
Table 21. Fit indices and modifications for Perceived usefulness (PU).....	76
Table 22. Fit indices and modifications for Confirmation (CON)	77
Table 23. Fit indices and modifications for overall CFA model	78
Table 24. Collinearity statistics (Inner VIF values).....	80
Table 25. The R ² of endogenous latent variables.....	80
Table 26. The f ² effect sizes.....	81
Table 27. Predictive relevance Q ²	82
Table 28. The q ² effect sizes	82
Table 29. Summary of the structural model	84
Table 30. Summary of the hypotheses (H1. and H2.)	88
Table 31. Summary of the hypotheses (H3. and H4.)	90
Table 32. An overview of the research	93

LIST OF FIGURES

Figure 1. Expectation-Confirmation Theory (ECT) (D. J. Kim, 2012, p. 222; Oliver, 1980, p. 462)	11
Figure 2. Expectation-Confirmation Model of Information System Continuance (Bhattacharjee, 2001, p. 353).....	12
Figure 3. Nielsen’s acceptability hierarchy (H. C. Kim, 2015, p. 233)	16
Figure 4. PRISMA flow diagram of the literature review process (Boland et al., 2017, p. 40)	22
Figure 5. Research model (usability-extended ECM) and hypotheses.....	34
Figure 6. A high-level overview of the CRISS platform.....	36
Figure 7. Research design (Saunders et al., 2016, p. 164)	40
Figure 8. Modifications in Perceived effectiveness.....	74
Figure 9. Modifications in Perceived efficiency	75
Figure 10. Modifications in Perceived usefulness	76
Figure 11. Modifications in Confirmation	77
Figure 12. Modifications in the overall CFA model	78
Figure 13. Structural model (Inner model: path coefficients and p-values; Constructs: R Square).....	84
Figure 14. Isolated mediation model PFE -> SAT -> CI	87
Figure 15. Isolated mediation model PFI -> SAT -> CI	87
Figure 16. SAT -> CI relationship moderated by level of a computer skill	89
Figure 17. SAT -> CI relationship moderated by the duration of use.....	89
Figure 18. Structural model (Moderator: Level of computer skill; Inner model: path coefficients and p-values; Constructs: R Square).....	91
Figure 19. Structural model (Moderator: Duration of use; Inner model: path coefficients and p-values; Constructs: R Square).....	92
Figure 20. Structural path results.....	96

LIST OF ABBREVIATIONS

AGFI	Adjusted Goodness-of-Fit Index
AVE	Average Variance Extracted
CA	Cronbach's Alpha
CB-SEM	Covariance-Based Structural Equation Modelling
CFA	Confirmatory Factor Analysis
CFI	Comparative Fit Index
CI	Continuance intention
CON	Confirmation
CR	Composite Reliability
DC	Digital competence
DF	Degrees of freedom
ECM	Expectation-Confirmation Model of Information System Continuance
ECT	Expectation-Confirmation Theory
GFI	Goodness-of-Fit Index
HCI	Human-Computer Interaction
HTMT	Heterotrait-Monotrait Ratio of the correlations
ICT	Information-Communication Technology
IS	Information System
M	Mean
PFE	Perceived effectiveness
PFI	Perceived efficiency
PLS-SEM	Partial Least Squares Structural Equation Modelling
PU	Perceived usefulness
RMR	Root Mean Square Residual
RMSEA	Root Mean Square Error of Approximation
SAT	Satisfaction
SD	Standard Deviation
SEM	Structural Equation Modelling
SRMR	Standardized Root Mean Square Residual
TAM	Technology Acceptance Model
TLI	Tucker–Lewis Index
TPB	Theory of Planned Behaviour
TRA	Theory of Reasoned Action
VIF	Variance Inflation Factor

1 INTRODUCTION

This thesis studies the extent to which perceived usability impacts users' continuance intention to use the system for acquisition and evaluation of digital competences within primary and secondary education. This chapter outlines the main motivation and identified literature gaps that guided the thesis candidate through the research. Followed by the main aim and proposed research question, the research objectives are formulated and concretized through four hypotheses. Next, the research context and methodology are presented. Finally, the expected scientific contributions and the structure of the thesis are addressed.

1.1 Motivation and Research Problem

Most frameworks (Technology Acceptance Model, Theory of Reasoned Action, Theory of Planned Behaviour, etc.) that study user behaviour in the field of Information Systems (IS) imply that continuance intention to use is an extended part of user acceptance (Bhattacharjee, 2001; Bhattacharjee & Barfar, 2011). Therefore, they apply the same set of pre-acceptance variables to explain the continuance, i.e. the long-term use of an IS, ignoring the users who discontinue its use, although they have initially accepted it.

Bhattacharjee was among the first pioneers to consider the differences between the behaviour of acceptance and continuance, and in 2001 proposed the **Expectation-Confirmation Model of IS Continuance** (hereinafter referred to as ECM) that can explain user post-adoption behaviour (Bhattacharjee, 2001). The literature confirmed that the success of IS depends more on continuance use than on initial acceptance and that the research focus should be shifted to studying user post-adoption behaviour of a particular IS which in return will have a greater impact on its long-term sustainability (Nascimento et al., 2018; Wang et al., 2019). Furthermore, Ambalov's (2018) meta-analysis of relevant ECM studies concludes that the model itself provides consistent results and can be applied in different technological contexts. In a narrower sense, the theoretical assumptions of the model are supported. An empirical basis is ensured for generalizing model-based predictions for different populations of respondents and a statistical basis for future research in this area is

provided. It has also been observed that the theoretical extension of the original ECM can increase its explanatory power (Bhattacharjee et al., 2008).

The antecedents of IS continuance intention within ECM are derived from many different streams of literature. It is believed that variables from Human-Computer Interaction (HCI) area could be relevant for explaining the use in technological context (Thong et al., 2006). A few results have shown that usability plays a key role in users' initial, but also continuance intention to use the IS (Najmul Islam et al., 2017; Pee et al., 2018). However, usability is often researched in very limited ways. Therefore, it is possible to achieve a different research approach than it is commonly used in the IS literature by extending the ECM model with usability variables (Hoehle & Venkatesh, 2015). This is also supported by Najmul Islam et al. (2017) who conclude that perceived usefulness, which is in the original ECM, cannot sufficiently explain decisions related to continuance intention to use the IS, thus this should be achieved by adding usability. They also have identified the lack of studies that examine perceived usefulness and usability together within the same research model.

However, **usability** is rarely considered one-sided (Hertzum, 2010), but rather related to several aspects of the IS that are needed to be considered (Casaló et al., 2008): (1) the speed of finding relevant data; (2) the ease of navigating through the system in terms of time and number of actions required to achieve the desired results; (3) the knowledge of what is being done and where it is located at any point in time of system use; (4) the ease of understanding the interface, structure, functions and system content. In practical terms, usable systems help users to better understand the content, navigate the system more easily and achieve the desired results with simplicity. Moreover, studies have shown that users have a very low tolerance threshold for slow systems and poor design that will require effort and time to learn to work with it which will consequently lead to its abandonment (Najmul Islam et al., 2017; Yassierli et al., 2018). With this in mind, it is approached to the extension of original ECM by adding perceived usability (hereinafter referred to as **usability-extended ECM**).

It was decided that the development of the research model (usability-extended ECM) and related instrument will be directed towards the well-known ISO 9241(2018) definition of usability: "*the extent to which a system, product or service can be used by specified users to achieve specified goals with effectiveness, efficiency and satisfaction in a specified context of use*". On that account,

usability is further decomposed into effectiveness and efficiency while the **satisfaction**, as a part of the original ECM, is theoretically extended to fully reflect the “*positive attitudes, emotions and/or comfort resulting from use*” (Bevan et al., 2016, p. 270). As for the new variables in the model, the **perceived effectiveness** is measured in terms of users’ perception of “*accuracy, completeness and lack of negative consequences with which users achieved specified goals*” (Bevan et al., 2016, p. 269), and **perceived efficiency** as users’ perception of “*resources used (typical resources include time, human effort, costs and materials) in relation to the results achieved*” (ISO 9241-11, 2018). Other variables (perceived usefulness, confirmation and IS continuance intention) in the proposed research model are derived from the original ECM. Operational definitions of all variables within the research model were adapted to the research context.

As a baseline for the thesis, a comprehensive literature review has been performed that has found a limited number of studies that addressed the usability extension of the ECM. It is noticed that the number of such studies is increasing over the years, and research has been conducted in the context of shopping website (Atcharyachanvanich et al., 2007; Pee et al., 2018), e-textbooks (Baker-Eveleth & Stone, 2015; Gelderblom et al., 2019), online learning environment (Daghan & Akkoyunlu, 2016), website for jobseekers (Eveleth et al., 2015), mobile applications and services (Gupta et al., 2020; Hong et al., 2006; K. H. Kim et al., 2019; Oghuma et al., 2016; Tan et al., 2018), professional social networking site (Najmul Islam et al., 2017), consumer electronic product (Lim et al., 2019), smartwatches (Nascimento et al., 2018) and an ERP system (Rizana & Govindaraju, 2016). Although the respondents were university students in most of the reported contexts, a lack of studies that applied the aforementioned theoretical extension of the ECM in the educational systems was discovered. Only a few studies were found to support the effect of usability on the continuance intention to use in the context of systems that support teaching and learning processes (Baker-Eveleth & Stone, 2015; Daghan & Akkoyunlu, 2016; Gelderblom et al., 2019; Najmul Islam et al., 2017).

Regarding education, future efforts are oriented towards teaching and learning based on **digital competence (DC)** within primary, secondary and higher schools, because recent research has shown that, in future, 90% of jobs will require at least basic DC that 43% of European citizens still do not have (Beblavý et al., 2019). The term “**digital competence**” used here, but also throughout

this thesis, refers to “*the set of knowledge, skills, attitudes*” (Ferrari, 2012, pp. 3–4) that “*involves the confident, critical and responsible use of, and engagement with, digital technologies for learning, at work, and for participation in society*” (Council of the European Union, 2018). Although there are various initiatives and policies at the European level (Carretero et al., 2017; Council of the European Union, 2018), there is a scarce number of studies discussing the lack of DC in primary and secondary schools (Lazonder et al., 2020; Stopar & Bartol, 2019). Most studies are oriented towards higher education (Cordero & Mory, 2019; Engelbrecht et al., 2018), although it is considered that the acquisition of DC should be started at an early age to reduce the risk of social exclusion as well as foster the entering into the labour market. That way, they would use the technology more efficiently and the teachers could notice the lack of DC on time and intervene properly (Casillas Martín et al., 2019; Hurwitz & Schmitt, 2020; Siddiq et al., 2016).

Instead of content-based education, a competency-based education would certainly accelerate the process of developing DC, and in this direction, there is a trend of developing systems that would support this (Scherer et al., 2019). The purpose of such systems is to help students with the support of their teachers, to acquire different DC that will be evaluated through various certificates, and thus more easily recognized in the labour market. Although many studies examine students, it is very important to analyse the teachers’ perception of a specific system used within educational processes (Rolf et al., 2019), since they are recognized as “primary agents of school change” (Lukacs & Galluzzo, 2014). Therefore, it is important to investigate the variables that would influence teachers’ continuance intention to use such systems within their classes. That being said, the *main research question* is proposed: **What are the most important variables in determining the continuance intention to use the system for acquisition and evaluation of digital competences?**

A review of the literature did not identify any example of measuring the long-term sustainability of systems for DC acquisition and evaluation. Therefore, the usability-extended ECM was in line with the HCI area which emphasized the need to examine the usability of systems that support educational processes (Granić & Čukušić, 2011; Tulinayo et al., 2018). In view of the foregoing, the main *aim* of this thesis is **to determine the extent to which perceived usability impacts users’ continuance intention to use the system for acquisition and evaluation of digital competences within primary and secondary education.**

1.2 Research Objectives and Hypotheses

Based on the main aim of the thesis stated in the 1.1 Motivation and Research Problem, the following **research objectives** were set:

RO1. To identify in the literature expectation-confirmation models that are extended with usability constructs.

RO2. To develop the research model for measuring the continuance intention to use the system for acquisition and evaluation of digital competences.

RO3. To develop a valid instrument for measuring the continuance intention to use the system for acquisition and evaluation of digital competences.

RO4. To determine the cause-and-effect relationships between variables of an extended research model using the method of structural equation modelling (SEM).

The following **hypotheses** emerged from the stated research objectives:

H1. Satisfaction mediates the relationship between perceived effectiveness and continuance intention to use the system for acquisition and evaluation of digital competences. (Mediation)

H2. Satisfaction mediates the relationship between perceived efficiency and continuance intention to use the system for acquisition and evaluation of digital competences. (Mediation)

H3. Level of computer skill moderates the relationship between satisfaction and continuance intention to use the system for acquisition and evaluation of digital competences. (Moderation)

H4. Duration of use (number of hours per week) moderates the relationship between satisfaction and continuance intention to use the system for acquisition and evaluation of digital competences. (Moderation)

1.3 Research Context

The proposed research model (*usability-extended ECM*) is applied in the context of a modular cloud-based **system for acquisition and evaluation of DC** (hereinafter referred to as **the CRISS platform**) which is extensively discussed in sub-chapter 3.3 of this thesis.

The CRISS platform is based on a new methodological framework created as a result of the analysis of the Digital Competence Framework for Citizens (DigComp 2.1), but also other relevant frameworks related to the student population (Balaban et al., 2019).

The platform enables teachers to monitor and evaluate the DC of students through various interdisciplinary problem situations, namely competence assessment scenarios (CAS) that can be related to one or more subjects or learning projects. Besides the formal school curriculum, the platform is also applicable in other educational contexts. The CRISS platform is part of a growing trend aimed at reducing the digital divide in society and providing transparency of individual's DC in the labour market.

1.4 Research Methodology

In Chapter 4 and partially in Chapter 5 of this thesis, the research methodology is introduced with comprehensively described research design through six layers of the **research “onion”** (Saunders et al., 2016): philosophy, approach, methodological choice, strategy, time horizon, techniques and procedures.

Positivism and **deduction** were chosen as suitable philosophy and approach for conducting the research considering its nature and the worldview of the thesis candidate (Creswell, 2014). The **sequential mixed methods** (Creswell, 2014; Saunders et al., 2016) fit the aim of the thesis and therefore were utilized in the research design through a four-phase procedure. The *first phase* concerned a comprehensive review of the literature to identify models or theories that were extended with usability constructs. A total of 46 items were derived from the literature and adapted to the research context of the CRISS platform. In the *second phase*, 11 experts participated in the scale development of the sent instrument. In this phase, all items identified as “not necessary” were excluded from the instrument. In the *third phase*, four focus groups were conducted in addition to the previous phases and as the final contribution to the instrument development. Finally, a 29-item

survey instrument was established. In the last, fourth phase, pre-testing and full-scale testing of the survey instrument were conducted among teachers in primary and secondary schools across six European countries. Specifically, a **cross-sectional survey strategy** has been utilized for this research because the time of data collection was limited due to delays in the development of the CRISS platform and shorter use in schools. As a result, a total of 353 completed surveys returned for the analysis. **Techniques and procedures** that are related to sampling design and instrument development are described thoroughly in sub-chapters of Chapter 4, while data analysis and results are separately explained in Chapter 5 because of the thesis consistency.

1.5 Expected Scientific Contributions

The literature has identified two main, but related research gaps, a lack of studies that examine user behaviour after the adoption of a particular IS, and especially, in relation to the usability of systems that support teaching and learning processes. The main scientific contributions are reflected in the following:

- (1) Development of a usability-extended ECM that is tested in a new technological context
- (2) Development of an instrument to measure the continuance intention to use the system for acquisition and evaluation of digital competences
- (3) Identification of the extent to which perceived usability contributes to the continuance intention to use the system for acquisition and evaluation of digital competences.

1.6 Thesis Outline

The thesis consists of seven main chapters briefly described in Table 1.

Table 1. Thesis outline

Chapters	Description
Chapter 1 Introduction	Chapter One provides an overview of planned research. It depicts identified gaps in the IS and HCI literature. It also reveals the subject area of research interest. The main aim of the thesis is defined, and it is followed by the research question, objectives and hypotheses. The research methodology comprises a short overview of conducted theoretical and empirical research. Finally, expected scientific contributions are listed.
Chapter 2 Literature Review	Chapter Two provides a review of the ECM, the underlying theory, process of development through other frameworks and contexts of application. Different definitions of usability are also presented, which are generally accepted and used among scholars. A comprehensive literature review includes the analysis and synthesis of previous studies which have examined the ECM extended with usability constructs.
Chapter 3 Research Model and Hypotheses	Chapter Three presents the development of a new research model, the usability-extended ECM. It provides an operational definition for each construct in the model. A rationale for each of the proposed hypotheses is presented, as well as the context in which the research is conducted.
Chapter 4 Research Methodology	Chapter Four features the implementation of the research methodology through chosen research design, sampling design, instrument development, and legal and ethical considerations.
Chapter 5 Data Analysis and Results	Chapter Five contains the summarized results of respondents' characteristics and general descriptive statistics of the conducted survey instrument. This is followed by the assessment of measurement model in terms of reliability, convergent and discriminant validity, and goodness-of-fit. Path, mediator and moderator analyses are exhibited within the structural model assessment.
Chapter 6 Discussion of Results	Chapter Six delivers a short overview of the conducted research and a discussion on obtained findings.
Chapter 7 Conclusion	Chapter Seven provides conclusion based on the obtained results. The contribution of the thesis is described in terms of theory and practice. There are also provided limitations and suggestions for future research.

2 LITERATURE REVIEW

The literature review process is conducted to build the foundation of the thesis by identifying studies that have extended Bhattacharjee's Expectation-Confirmation Model (ECM) (2001) with usability constructs. However, this comes after the explanation of ECM and usability regarding their theoretical and empirical development over the years. As a result of the conducted literature review and the identification of gaps, a new research model is established and described in the subsequent chapter.

2.1 Expectation-Confirmation Model (ECM)

In the Information System (IS) literature, Kim and Crowston (2011) identified two categories of studies: adoption (initial acceptance) and post-adoption (continuance use).

The **adoption** behaviour was widely studied with social psychology theories - Theory of Reasoned Action (TRA) (Fishbein & Ajzen, 1975) and Theory of Planned Behaviour (TPB) (Ajzen, 1991), but also with other well-known frameworks such as (Y. Kim & Crowston, 2011): Innovation Diffusion Theory (IDT) (Rogers, 1962), Social Cognitive Theory (SCT) (Bandura, 1986), Technology Acceptance Model (TAM) (Davis, 1989), Extended Technology Acceptance Model (TAM2) (Venkatesh & Davis, 2000) and Unified Theory of Acceptance and Use of Technology (UTAUT) (Venkatesh et al., 2003). However, it was argued that those theories cannot explain the dynamics of post-adoption behaviour when users consciously explore the IS they use (Bhattacharjee & Barfar, 2011; Sheppard & Vibert, 2019), because they are predominantly "*focused on adoption as one-time event*" (Y. Kim & Crowston, 2011, p. 7).

Thus, the **post-adoption** research was described as "*one of the most welcome developments in recent Information Systems*" (De Guinea & Markus, 2009, p. 433). The focus is on the continuance use which is "*not a one-time event, but may better be envisioned as the result of a series of individual decisions to continue using a particular IS, thereby reflecting its longitudinal nature*" (Limayem et al., 2007, p. 707). Bhattacharjee (2001) was one of the first researchers that offered an explanation for post-adoption behaviour in IS by proposing the **Expectation-Confirmation Model of IS continuance** (hereinafter abbreviated as **ECM**). His work was based on (1980)

Expectation-Confirmation Theory (ECT), the leading cognitive theory in the area of consumer satisfaction which is considered “*a post-purchase attitude formed through a mental comparison of the service and product quality that a customer expected to receive from an exchange and the level of service and product quality the customer perceives from the exchange*” (D. J. Kim, 2012, p. 220).

Furthermore, satisfaction has shown to be important for building long-term relationships with consumers and retain their interest in a product or service they have previously used (Anderson & Sullivan, 1993; Oliver, 1980). The following confirms it: “*Investing in customer satisfaction is like taking out an insurance policy. If some temporary hardship befalls the firm, customers will be more likely to remain loyal*” (Anderson and Sullivan, 1993, as cited in Bhattacharjee, 2001, p. 353). The concept of satisfaction was comprehensively discussed in marketing (Oliver & Burke, 1999; Patterson et al., 1997; Selnes, 1998), psychology (Z. Chen, 2001), IS (Cyr, 2008; Flavián et al., 2006; Lee & Overby, 2004) and management literature (Anderson & Sullivan, 1993).

The cause and effect of satisfaction are explained in ECT through its antecedents and formation process (Susarla et al., 2003) which is depicted in Figure 1. Consumers form an initial expectation (**Expectation**) about the product or service performance before purchasing it. The expectation can be described as “*to what consumers believe they should and will receive from sellers through the transaction*” (D. J. Kim, 2012, p. 222). After the period of initial use, consumers form a post-purchase perception about its performance (**Perceived performance**). They compare and evaluate perceived performance against the original expectation (pre-purchase attitude) and decide to what extent their expectations are confirmed (**Confirmation**). Based on the level of confirmation and expectation, they experience satisfaction (**Satisfaction**). The repurchase intention (**Repurchase intention**) is formed when consumers are satisfied, while dissatisfied consumers can complain, discontinue the use of a product or service and/or find a proper substitute. Practically, the lower expectation and/or higher perceived performance leads to a greater confirmation which brings higher satisfaction to consumers and encourages them to repeat purchases. Otherwise, their attitudes are negatively affected, and the purchase is discontinued. Overall, the ECT was successfully applied to demonstrate consumers repurchase intention in many contexts such as restaurant service (Kivela et al., 1999; Swan & Trawick, 1981), durable and nondurable products (Churchill & Surprenant, 1982), camcorder (Spreng et al., 1996), automobile (Oliver, 1993),

photographic products (Dabholkar et al., 2000) and business professional services (Patterson & Spreng, 1997).

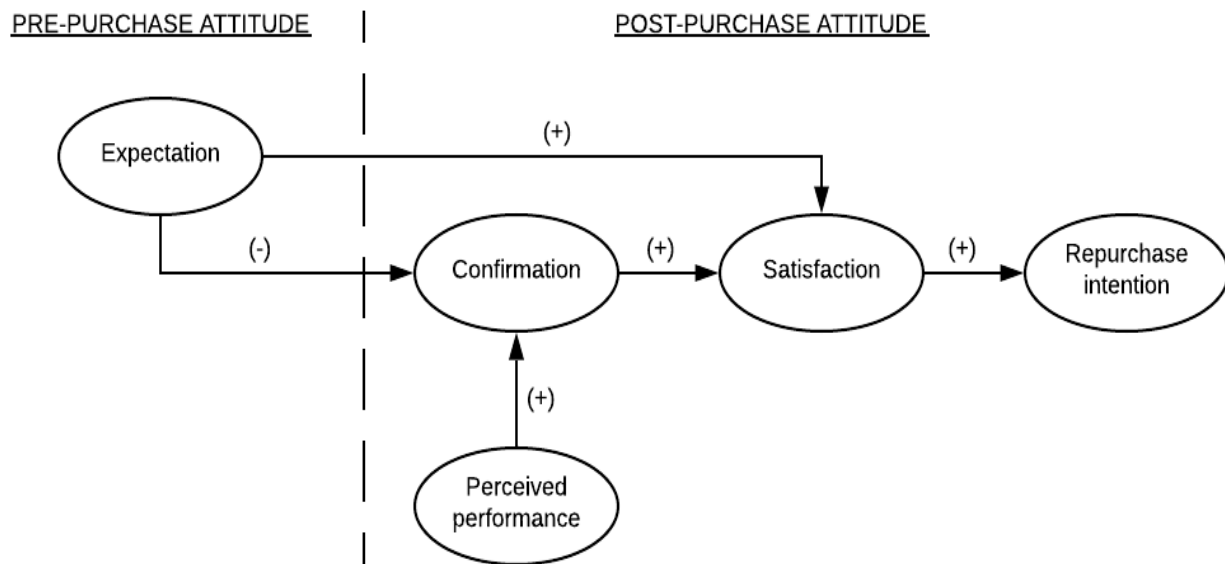

Figure 1. Expectation-Confirmation Theory (ECT)

(D. J. Kim, 2012, p. 222; Oliver, 1980, p. 462)

Although the ECT proved applicable to a wide range of contexts, it was the topic of several debates. Researchers Bhattacharjee (2001), as well as Hossain and Quaddus (2012), summarized them as follows:

- Definitional ambiguities of satisfaction, expectation and confirmation variables
- Relationship anomalies among ECT variables
- Measurement anomaly based on the selection of an adequate phase of measuring the variables and application of the right measurement methods
- No additional variables are included as antecedents of continuance intention besides the satisfaction
- ECT neglects that consumers' expectation can potentially change regarding the received information or first-hand experience
- Logical inconsistency between high/low expectations and performance that cannot be explained by ECT.

The stated issues are overcome with already mentioned ECM (Bhattacharjee, 2001) that is developed to explain the **continuance use behaviour of IS users**. In ECM shown in Figure 2, Bhattacharjee replaced the ECT's Expectation with the Perceived usefulness for which longitudinal studies have shown to be an important variable for explaining the IS post-adoption behaviour (Barnes & Böhringer, 2011). However, this variable was often mixed with the (pre-usage) perceived usefulness from TAM (Bhattacharjee et al., 2008). Moreover, in the IS continuance context, perceived usefulness has shown to be the long-term belief for which has been proven to affect user intention from the initial to later temporal stages of IS use (Karahanna et al., 1999).

Also, ECT's Perceived performance is replaced by **Confirmation** which is defined as “*the congruence between the expectation of use and its actual performance*” (Bhattacharjee, 2001, p. 359). In the ECM, **Satisfaction** and **Perceived usefulness** are directly connected to **IS continuance intention**. The ECM predominantly studies post-acceptance variables (i.e. Perceived usefulness as “post-usage expectation”), but “*the effects of any pre-acceptance variables are already captured within the confirmation and satisfaction constructs*” (Bhattacharjee, 2001, p. 355).

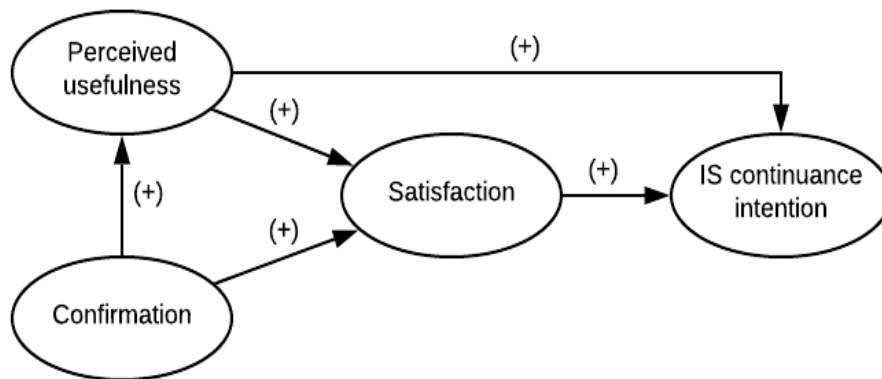

Figure 2. Expectation-Confirmation Model of Information System Continuance
(Bhattacharjee, 2001, p. 353)

Previously, ECT researchers considered satisfaction to be the single important variable for retaining the user interest (trigger for the repurchase intention in the ECT) (Anderson & Sullivan, 1993; Hossain & Quaddus, 2012; Oliver, 1980), but findings have shown that users' continuance intentions depend on whether they consider the IS to be beneficial or useful (Bhattacharjee, 2001;

Bhattacharjee & Premkumar, 2004; D. J. Kim, 2012). However, IS continuance decisions from ECM and repurchase decisions from ECT share some equal characteristics (Bhattacharjee, 2001):

- Follow an initial user decision
- Both are impacted by the initial use or experience
- Both can potentially lead to a change of the initial decision after some period of use or experience with the service or product.

The antecedents of IS continuance are dominantly satisfaction and perceived usefulness, but there are also other found variables such as **perceived ease of use** (Cheng, 2014b; Hong et al., 2006; Y. S. Kang et al., 2009; Recker, 2010; Shang & Wu, 2017; Thong et al., 2006; Zhou, 2011), **perceived enjoyment** (Alraimi et al., 2015; Y. S. Kang et al., 2009; B. Kim, 2010; Oghuma et al., 2016; Thong et al., 2006), **flow** (Cheng, 2014a), **perceived playfulness** (C. S. Lin et al., 2005), **perceived usability** (Daghan & Akkoyunlu, 2016; Najmul Islam et al., 2017; Oghuma et al., 2016; Pee et al., 2018), **customer loyalty** (Atcharyachanvanich et al., 2007), **perceived incentives** (Atcharyachanvanich et al., 2007), **perceived value** (Daghan & Akkoyunlu, 2016), **utilitarian value** (Daghan & Akkoyunlu, 2016; Rizana & Govindaraju, 2016), **post-adoption self-efficacy** (Gupta et al., 2020), **engagement** (K. H. Kim et al., 2019), **habit** (Nascimento et al., 2018), and **usability** in terms of app dependability, app utility, graphics, UI input and output (Tan et al., 2018).

Over the years, the ECM has been integrated with well-known theories and models (Terzis et al., 2013), the most commonly with **Theory of Planned Behaviour** (B. Kim, 2010; Liao et al., 2007), **Technology Acceptance Model** (Cheng, 2014b; Ramayah et al., 2016; Shang & Wu, 2017; Zhou, 2011) and **IS Success Model** (Cheng, 2014a, 2014b; Venter & Swart, 2018).

Overall, the ECM has shown to be useful in technological contexts for explaining the continuance use of **web online shopping** (Hozhabri et al., 2014; Pee et al., 2018; I. L. Wu & Huang, 2015), **mobile online shopping** (Hew et al., 2016; C. R. Kang et al., 2010; Shang & Wu, 2017), **instant messaging services** (Oghuma et al., 2016; Song & Wang, 2011), **e-learning** (Alraimi et al., 2015; Cheng, 2014a; Daghan & Akkoyunlu, 2016; Junjie, 2017; W. S. Lin, 2012; Pang & Jen, 2018; Roca et al., 2006), **m-learning** (Joo et al., 2016), **e-banking** (Susanto et al., 2016, 2012; Tsai et al., 2014), **educational technologies** (Hopkins et al., 2017; Ifinedo, 2018; Joo et al., 2017; Rauf et al., 2016; Stone & Baker-Eveleth, 2013; Venter & Swart, 2018), **social commerce** (Hsu et al.,

2015; Jang et al., 2013; Zhang et al., 2015), **social network sites** (Kourouthanassis et al., 2015; Liu, 2014; Mouakket & Bettayeb, 2015; Wang & Du, 2014), and **information systems** (Sørenbø & Eikebrokk, 2008; Venkatesh & Goyal, 2010).

2.2 Usability

In the previous chapter, it can be noted that antecedents of IS continuance are derived from many different streams of literature. It is believed that variables from **Human-Computer Interaction (HCI)** area could also be relevant for explaining the technology use (Thong et al., 2006). Usability is a ubiquitous concept in the field of HCI to the extent that it is often utilized without being clearly defined (Hertzum, 2010). On the other hand, numerous established definitions of usability could be found in the literature and widespread classic examples will be provided below.

It is considered that the term **usability** was first used in the quotation “*It is not the utility, but the useability of a thing which is in question*” (Thomas De Quincey, 1842, as cited in Hertzum, 2010, p. 567), but the first attempt of the definition came later by **Miller** (1971) who were explaining it within the term “ease of use”. This attempt at describing usability was further developed by **Bennett** (1979). There is also an opinion that usability was intended to replace the term “user-friendly” (Bevan et al., 1991). Regardless of the origins, the definition of usability has evolved in different directions over the years. In the 1980s, when companies like IBM and Apple began to produce computers available to, not just technical experts, but also to the general public, the question of the ease of use was further raised (Schoeffel, 2003). The development of software and other computing equipment led to increasing demand for their easier use by ordinary users, and it is believed that this brought advancement in computerization and ultimately the Internet, but also to the development of international standards which will be discussed later.

Shackel (1981) contributed to a broader discussion of researchers and attempted to operationalize a formal definition of usability which was, after a while, refined by Bennett (1984). First attempts of definitions have been criticised for being too general and not having quantifiable or measurable significance (B. Shackel, 2009). Later, **Eason** depicted usability as a “*product of the interaction of three variables (system, task and user) which feed into the user’s response to each task episode*” (Eason, 1984, p. 137). He presented a causal framework of usability where user reaction is a

dependent variable impacted by system functions, task characteristics and user characteristics. In 1991, **Shackel** introduced the usability concept as “*the capability in human functional terms to be used easily and effectively by the specified range of users, given specified training and user support, to fulfil the specified range of tasks, within the specified range of environmental scenarios*” (B. Shackel, 2009, p. 340). He also suggested a more convenient form of the definition “*the capability to be used by humans easily and effectively*” (B. Shackel, 2009, p. 340). Afterwards, he pointed out that for the system to be usable, the following criteria must be achieved: learnability, effectiveness, attitude and flexibility. Later, some have questioned Shackel’s approach of describing usability for being overly rigid because he relied on only quantitative usability attributes (Cox & Walker, 1993). However, as a provider of the first formal definition of usability, he opened the way for many other studies in the field.

Another influential researcher in the usability field is **Nielsen** (1993) who introduced and precisely defined five usability attributes for examining the interface of a software system: learnability, efficiency, memorability, errors and satisfaction. He argued that the systematic approach to usability is needed and referred to it as “usability engineering”. Although at first glance, Nielsen and Shackel share only one usability variable – learnability, it is possible to find semantic overlap between other variables concerning their operational definitions (e.g. relatedness between Nielsen’s errors and Shackel’s effectiveness, and the same goes for Nielsen’s satisfaction and Shackel’s attitude). This is one of the proofs of how difficult it was for the researchers to decide which specific variables make a product usable. Moreover, Nielsen (1993) identified usability and utility as two distinguished variables of usefulness, which itself was a subcategory of practical acceptability as a higher-level concept (see Figure 3). He decided that utility is the question of whether the product provides the necessary functionalities to users and usability is the question of how well those functionalities can be used by users. Although the definition of utility remained almost the same over the years, Nielsen (2012) slightly changed the direction of usability to how easy and pleasant the features of the system are to use. Moreover, it is the distinction between utility-usability terms that has led to a shift in focus from product-centred to user-centred design in the 1980s which was further developed ever since.

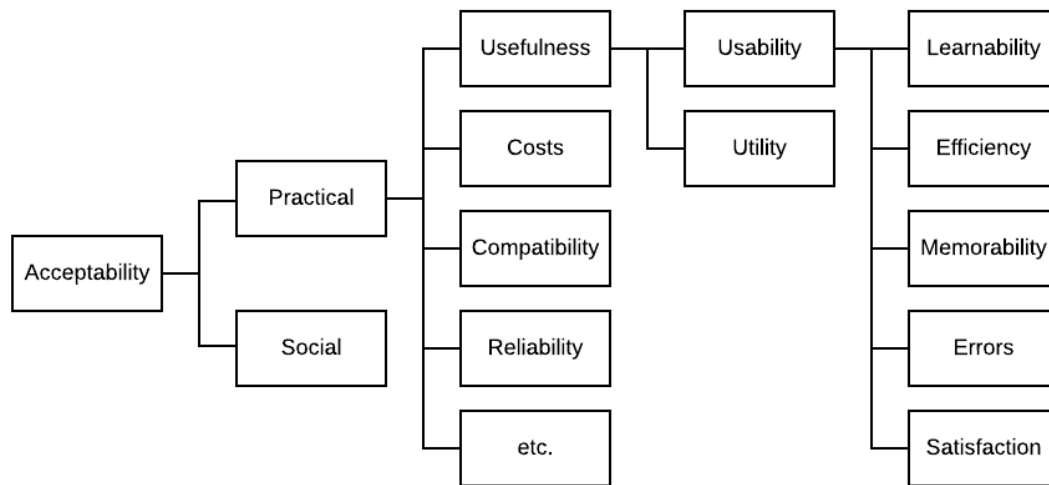

Figure 3. Nielsen’s acceptability hierarchy (H. C. Kim, 2015, p. 233)

Although every designer would like to improve each of the above-enumerated variables, there are inevitable “trade-offs” that were researched by **Norman** (1986, 1983). For example, the speed of performance would have to be sacrificed if lengthy learning is allowed or if the error rate is kept low. The trade-offs will also be likely to be made in usability when observing novices, intermittent or experienced users (Hammond et al., 1983). Therefore, it is important to clarify what are the primary purposes of the interface design and be aware of the needed trade-offs to acquire optimal results.

Bevan is known for his collaboration with the International Organization for Standardization (ISO) and contribution related to usability standards, but he was also among the first to point out the usability problem of computer systems that were still mostly designed for developers and less for ordinary users who could afford them due to lower costs (Bevan, 1982). **Bevan** and his co-researchers proposed the following definition of usability: “... *the ease of use and acceptability of a product for a particular class of users carrying out specific tasks in a specific environment*” (Bevan et al., 1991, p. 1). They concluded that the change in characteristics of a product, system, user, task, or environment, results in the change in usability. The further research and development of usability attributes by others were also impacted by their statement “*a product is not itself usable or unusable, but has attributes which will determine the usability for a particular user, task and environment*” (Bevan et al., 1991, p. 4). Relating usability to business objectives and that achieving

“quality in use” was relatively new in the 1990s when **Bevan** introduced it (Bevan, 1995). He put “quality in use” as the major goal for designing interactive products.

Additionally, usability requirements should be determined based on efficiency, effectiveness and satisfaction required for a certain context. The achievement of these requirements can be validated by applying the user-based evaluation. The latter mentioned variables (effectiveness, efficiency and satisfaction) are part of a well-known process-oriented standard **ISO 9241** which defined usability in 1998 as: *“the extent to which a product can be used by specified users to achieve specified goals with effectiveness, efficiency and satisfaction in a specified context of use”* (ISO 9241-11, 1998). The work on ISO 9241 began in 1983 by developing Ergonomic requirements for office work with visual display terminals (VDTs) since in the 1970s there was a growing concern related to display screen work (Stewart, 2000). In 2006, the standard was given a more generic title Ergonomics of human-system interaction. Over the years, it has undergone several revisions, the last done in 2018. The definition of usability remained unchanged, only the term “product” was substituted with “system, product or service”. The other well-known definition of usability was set by the product-oriented standard **ISO/IEC 9126** Software product evaluation - Quality characteristics and guidelines for their use as: *“a set of attributes that bear on the effort needed for use, and on the individual assessment of such use, by a stated or implied set of users”* (ISO/IEC 9126, 1991).

In general, the purpose of this standard was to provide a framework for software evaluation using six established quality characteristics (functionality, reliability, usability, efficiency, maintainability and portability) and sub-characteristics with measurable attributes. Defined characteristics did not represent the perspective of the manufacturer on the product, but aimed to satisfy the needs of the users (Bevan, 1997). The ISO/IEC 9126 did not contain specific quality requirements, but it provided a quality model which could be adapted to the software as needed. As a part of the quality model, the concept of usability was broken down into understandability, learnability and operability (ISO/IEC 9126, 1991). The software engineering community who worked on the international standard defined usability as a relatively independent variable that is focused on software attributes such as user interface (Bevan, 2001). Over the next ten years, the standard was revised, as well as the definition of usability: *“the capability of the software product to be understood, learned, used and attractive to the user, when used under specified conditions”*

(ISO/IEC 9126-1, 2001). Additionally, two more sub-characteristics, attractiveness and usability compliance, were classified under the usability characteristic. Although the ISO/IEC 9126-1 definition of usability included “specified conditions” which is similar to the “context of use” in ISO 9214, these two definitions were hardly overlapping. However, the similarity can be found in a definition of “quality in use” also proposed by ISO/IEC 9126-1: “*The capability of the software product to enable specified users to achieve specified goals with effectiveness, productivity, safety and satisfaction in a specified context of use*” (ISO/IEC 9126-1, 2001). This definition can be seen as complementary to the one of usability in ISO 9241 (Bevan, 2001). **Bevan** further proposed that these two standards should be merged to establish a standard for the usability of all kinds of interactive products and systems. This approach could also resolve the limitations in the application of existing standards back then. The standard ISO/IEC 9126-1 acknowledged that:

“usability is defined in ISO 9241-11 in a similar way to the definition of quality in use in this part of ISO/IEC 9126. Quality in use may be influenced by any of the quality characteristics, and is thus broader than usability” (ISO/IEC 9126-1, 2001).

In 2011, the latter standard was withdrawn and replaced by **ISO/IEC 25010** which provides Systems and software quality requirements and evaluation (SQuaRE). This standard also defines the product quality model and quality in use model as was the one it replaced. However, certain changes have been made to characteristics and related sub-characteristics. For example, the product quality model is refined and broadened to eight quality characteristics functional suitability, performance efficiency, compatibility, usability, reliability, security, maintainability and portability. Usability is retained within the quality model, but its set of attributes, except for learnability and operability, has changed and includes appropriateness recognizability, user error protection, user interface aesthetics and accessibility. On the other hand, quality in use in **ISO/IEC 9126** (2001) was defined in terms of effectiveness, productivity, safety and satisfaction while in **ISO/IEC 25010** (2011) it changes to effectiveness, efficiency, satisfaction, freedom from risk and context coverage. Usability “*is defined as a subset of quality in use consisting of effectiveness, efficiency and satisfaction, for consistency with its established meaning*” (ISO/IEC 25010, 2011). In both models, usability has gained significance as it “*can either be specified or measured as a product quality characteristic in terms of its sub-characteristics, or specified or measured directly*

by measures that are a subset of quality in use” (ISO/IEC 25010, 2011), and the confusion about its definition has ended since ISO/IEC 25010 aligned it with ISO 9241 (1998, 2018).

There was also an attempt of defining usability on behalf of **IEEE** within its Glossary of Software Engineering Terminology as “*the ease with which a user can learn to operate, prepare inputs for, and interpret outputs of a system or component*” (Institute of Electrical and Electronics Engineers, 1990). Their efforts to provide the vocabulary applicable to all systems and software engineering work were later supported by ISO and IEC. The definition of usability from ISO/IEC 25010 (2011) and ISO 9241 (2018) was accepted in all their later editions of the vocabulary.

Simultaneously, the body of usability literature was further developed by the researchers in the field. For example, **Quesenbery** (2001) proposed five E’s for describing usability based on Nielsen’s five qualities of a usable product: effective, efficient, engaging, error-tolerant and easy to learn. He criticized ISO 9241 for being too narrowly focused on well-defined tasks and objectives while emotional aspects are neglected and described as “*beyond usability*”. On the other hand, **Abran** et al. (2003) proposed the enhanced usability model using ISO 9241 as a baseline and adding learnability and security to it. Evidently, since the first appearance of the term usability until today, a universal agreement of researchers and experts on its definition has not been reached. However, it is considered that usability and related measures defined within ISO 9241 standard supported with many years of Bevan’s work (2001; 2016) are suitable for future research because of common terminology, agreed domain of knowledge among many groups of international experts that reflect current state-of-the-art, consolidated industrial experience, established categories of items and measurement units needed for the evaluation (Calero et al., 2010).

2.3 State of the Art on Usability in ECM

The process of identification and selection of available empirical studies is described first, followed by consolidated theoretical findings of the performed literature review.

2.3.1 Literature Review Process

The literature review process aimed to build a foundation for the thesis by identifying studies that have applied the Expectation-Confirmation Model (ECM) extended with usability constructs. As Webster and Watson highlighted: “*An effective review creates a firm foundation for advancing knowledge. It facilitates theory development, closes areas where a plethora of research exists, and uncovers areas where research is needed.*” (Webster & Watson, 2002, p. 13). According to Boland et al. (2017), **the literature review process** was divided into **four stages – identification, screening, eligibility and included**. Figure 4 shows the overall process conducted between September and December 2020 in a form of the Preferred Reporting Items for Systematic Review Recommendations (PRISMA) flow diagram.

In the first **identification stage**, eight scientific databases were searched by certain key terms and adapted search strategies. The search for relevant studies included several suitable online bibliographic databases (Dybå et al., 2007; Kitchenham, 2007): ACM Digital Library, IEEE Xplore, Inspec, Science Direct, Scopus, Springer Link, Wiley and Web of Science. A deductive process was used on the key concepts presented in the introductory chapters of this thesis to derive terms that built the search string for finding relevant studies. It was necessary to adapt the search strategy for each database since there is no standardized way of searching electronic resources, i.e. databases are different in many terms, e.g. interface, processing logical expressions, etc. (Dybå et al., 2007). With this in mind, a full-text search in bibliographic databases was conducted using a search string:

((“continuance intention” OR “expectation-confirmation”) AND “usability”)

Additionally, the snowballing procedure was used to detect additional relevant literature in references or citations of previously identified studies (Wohlin, 2014). As a result, 605 studies were identified for screening, the second stage.

In the **screening stage**, 58 studies were found as duplicates of the existing ones and, therefore, were eliminated from the further process. The remaining 547 studies were reviewed by titles, abstracts, and where necessary, the conclusion was read given that abstracts of studies in the information technology field are often considered insufficient when selecting primary studies (Kitchenham, 2007). All found studies were analysed against the predetermined inclusion criteria to ensure their quality. Criteria determined for the inclusion of studies were:

- (1) Full text was available
- (2) Published in English
- (3) Published in a peer-reviewed conference proceeding, book or journal
- (4) Published within the time frame 2001-2020
- (5) Termed as primary studies
- (6) Applied one or more constructs of ECM and usability within their research model.

Each study was compared against the determined inclusion criteria and if it did not meet them it was eliminated from the process. Otherwise, it was proceeded to the next stage. In total, 492 studies were excluded.

In the third stage of the process, full texts of 55 studies were thoroughly read and assessed for **eligibility**. All selected conference proceedings, book sections or journal articles had to meet the following eligibility criteria:

- (1) Included empirical findings
- (2) Cited Bhattacharjee (2001) as one of the sources for the research model development.

In total, 40 studies were removed because they did not meet the required criteria. A total of 15 studies was **included** in the fourth stage of literature review. Relevant findings were qualitatively synthesised as shown in Tables 2 and 3 of sub-chapter 2.3.2 Synthesis of Findings.

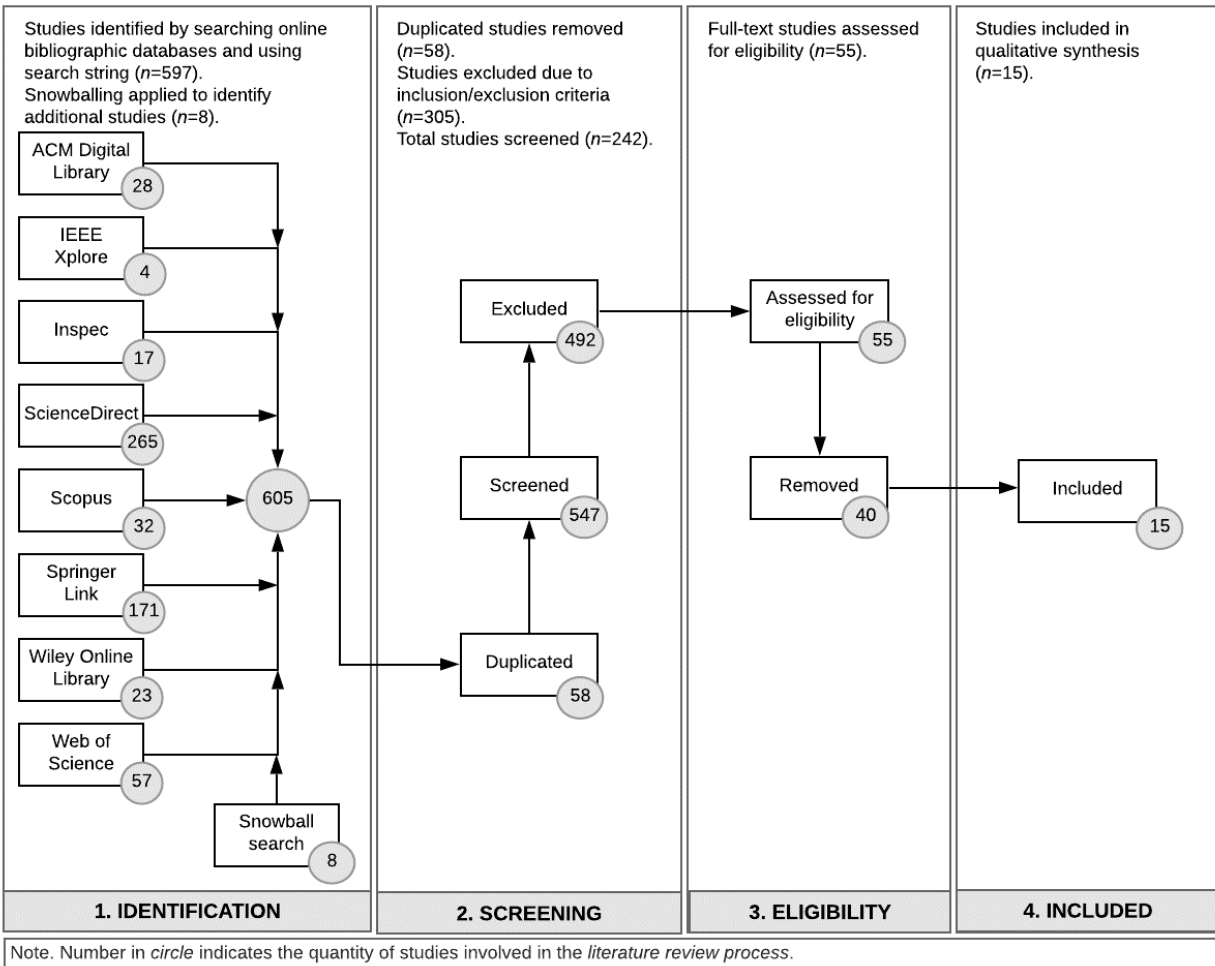

Figure 4. PRISMA flow diagram of the literature review process (Boland et al., 2017, p. 40)

Mendeley as a reference management tool was used to manage a large number of studies and to remove the duplicates. The found studies were scrutinized against the determined inclusion and eligibility criteria in order to be omitted or further processed.

2.3.2 Synthesis of Findings

A total of 15 studies published between 2006 and 2020 were included in the qualitative synthesis. These studies are summarized in Table 2. The sample size within studies ranged from 17 (Gelderblom et al., 2019) to 1,826 (Hong et al., 2006) respectively. Studies collected data from students (Baker-Eveleth & Stone, 2015; Daghan & Akkoyunlu, 2016; Gelderblom et al., 2019; K. H. Kim et al., 2019), non-students (Atchariyachanvanich et al., 2007; Gupta et al., 2020; Hong et

al., 2006; Najmul Islam et al., 2017; Nascimento et al., 2018; Oghuma et al., 2016; Pee et al., 2018; Rizana & Govindaraju, 2016; Tan et al., 2018), or both group of respondents (Eveleth et al., 2015; Lim et al., 2019). All selected studies used survey, except for one (Gelderblom et al., 2019) which combined eye-tracking test, in-depth interviews and focus group discussions to collect data from respondents. Most of them implemented their survey online, while others did not directly report on the method of implementation they have used (K. H. Kim et al., 2019; Oghuma et al., 2016; Rizana & Govindaraju, 2016). Their research model was usually an integration of the Expectation-Confirmation Model (ECM) and one or more of the following well-known frameworks - Technology Acceptance Model (TAM), Information Systems (IS) Success Model and Unified Theory of Acceptance and Use of Technology (UTAUT). On the other hand, some studies extended the existing ECM with certain theoretical construct with regard to the application context. In Table 2, it is noted whether a research model was a result of integration or extension. The included studies were conducted in various technological contexts such as online shops, e-textbooks, online learning environment, job-seekers website, mobile wallets, mobile internet, professional social networking site, mobile health services, consumer electronic products, smartwatches, mobile instant messaging, ERP system and disaster mobile applications.

Table 2. Summary of literature review

No	Study	Sample size (Group)	Data collection method	Research model (Extended/Integrated)	Research context
1	(Atcharyachanvanich et al., 2007)	1,215 (Online customers)	Online survey	Technology Acceptance Model; Expectation-Confirmation Theory; Model of Intention, Adoption, and Continuance (Integrated)	Online shops
2	(Baker-Eveleth & Stone, 2015)	639 (University students)	Online survey	Expectation-Confirmation Model (Extended)	E-textbooks
3	(Daghan & Akkoyunlu, 2016)	467 (University students)	Online survey	Technology Continuance Theory; Information Systems Success Model; Cognitive Model; Information Systems Expectation-Confirmation Model (Integrated)	Online learning environment
4	(Eveleth et al., 2015)	199 (University students; Contract workers)	Online survey	Expectation-Confirmation Model (Extended)	Jobseekers website

5	(Gelderblom et al., 2019)	17 (High school students)	Eye-tracking test; In-depth interviews; Focus group discussions	Expectation-Confirmation Model (Extended)	E-textbooks
6	(Gupta et al., 2020)	716 (M-wallet users)	Online survey	The Unified Theory of Acceptance and Use of Technology; Expectation-Confirmation Model (Integrated)	Mobile wallets
7	(Hong et al., 2006)	1,826 (Mobile Internet users)	Online survey	Expectation-Confirmation Model; Technology Acceptance Model (Integrated)	Mobile internet
8	(Najmul Islam et al., 2017)	125 (LinkedIn users)	Online survey	Expectation-Confirmation Model; Expectation-Confirmation Theory (Integrated)	Professional social networking site
9	(K. H. Kim et al., 2019)	191 (College students)	Survey	Expectation-Confirmation Model (Extended)	Mobile health services
10	(Lim et al., 2019)	308 (College students, friends, family, relatives, colleagues)	Online survey	Expectation-Confirmation Theory; Consumption Value Theory (Integrated)	Consumer electronic product
11	(Nascimento et al., 2018)	574 (Smartwatch users)	Online survey	Expectation-Confirmation Model (Extended)	Smartwatches
12	(Oghuma et al., 2016)	334 (MIM users)	Survey	Expectation-Confirmation Model; Expectation-Confirmation Theory (Integrated)	Mobile instant messaging
13	(Pee et al., 2018)	457 (Online shoppers)	Online survey	Signalling Theory; Expectation-Confirmation Theory (Integrated)	Online shop
14	(Rizana & Govindaraju, 2016)	223 (ERP users)	Survey	Expectation-Confirmation Theory; Technology Acceptance Model; Information Systems Success Model; Customer Value Theory (Integrated)	ERP system
15	(Tan et al., 2018)	271 (Disaster app users)	Online survey	Expectation-Confirmation Model (Extended)	Disaster mobile applications

The ECM (Bhattacharjee, 2001) was developed to capture users' post-adoption perception and decision-making processes about IS after having a prior experience of use. In that sense, researchers (Daghan & Akkoyunlu, 2016; Hong et al., 2006; Rizana & Govindaraju, 2016) emphasized the

need to identify and investigate variables that affect the continued use of IS over time given that much has already been researched regarding the acceptance and short-term use of IS. Furthermore, the literature review has revealed that usability is scarcely used in studies of IS users' continuance intention. Yet it is considered one of the critical success factors for predicting continuance intention and long-term use of IS (Atcharyachanvanich et al., 2007; Najmul Islam et al., 2017; Oghuma et al., 2016). It is also considered essential in both low-risk and high-risk context, as well as for testing users with low but also a high level of experience in IS (Pee et al., 2018). For these reasons, it is considered that extending ECM with usability constructs would provide an additional understanding of the model.

During the review, ten studies extended their research model with only *one* usability construct (Atcharyachanvanich et al., 2007; Daghan & Akkoyunlu, 2016; K. H. Kim et al., 2019; Lim et al., 2019; Najmul Islam et al., 2017; Nascimento et al., 2018; Pee et al., 2018), also using terms such as 'User interface quality' (Gupta et al., 2020), 'Perceived ease of use' (Hong et al., 2006) and 'Utilitarian value' (Rizana & Govindaraju, 2016). Although the terms used varied across studies, the researchers explained their relatedness to usability. Researchers Hong et al. stated '*perception of ease of use is closely related to usability design in that both are concerned with enhancing the way people interact with a system*' (2006, p. 1831), Rizana and Govindaraju indicated '*utilitarian value is user assessment towards value, benefit, and usability of the use... Utilitarian value is highly related to effectiveness and efficiency*' (2016, p. 3) and Gupta et al. said that '*the perceived user interface quality constitutes the overall usability*' (2020, p. 4). On the other hand, the remaining five studies used three to seven usability constructs theoretically supported to extend the model:

- Effectiveness, efficiency, engagement and ease of learning (Baker-Eveleth & Stone, 2015; Gelderblom et al., 2019)
- Engagement, content and feedback (Eveleth et al., 2015)
- Usefulness (utilitarian), enjoyment (hedonic) and user interface (features) (Oghuma et al., 2016)
- App design, app dependability, app utility, UI graphics, UI input, UI output and UI structure (Tan et al., 2018).

In a practical sense, by examining usability within the model it is possible to detect flaws in the design of which improvement would affect users' perception of system effectiveness and efficiency (Baker-Eveleth & Stone, 2015). Results of such examination could also predict the decision of teachers, i.e. trend of using a particular IS in teaching. Gelderblom et al. (2019) noted that during focus groups, students pointed out that teachers play an important role in their satisfaction with the IS. However, the literature review did not reveal any studies that used teachers as their target population for collecting data (see Table 2). Furthermore, most of the identified research was focused on the business context (e.g. online shops, mobile wallets, smartwatches, etc.) and their sustainable growth, and to a lesser extent on the educational contexts. Daghan and Akkoyunlu (2016) recommended that systems (e.g. learning management systems, mobile applications, etc.) applied in education should be subjected to testing in order to evaluate their continuance use among both students and teachers. The rationale for extending the ECM with usability was supported by identified studies that confirmed a significant effect of usability on continuance intention in different technological contexts. Key findings are discussed in Table 3.

Table 3. The summary of key findings

No	Study	Key findings
1	(Atchariyachanvanich et al., 2007)	<i>Usability</i> of the shopping website had a strong effect on <i>perceived ease of use</i> (e.g., a usable online store can save users time which affects their perception of ease of use). <i>Attitude toward purchasing</i> was predicted by perceived ease of use, perceived usefulness, perceived service quality and product offerings. Attitude toward purchasing in Internet shopping had a strong effect on the <i>behavioural intention to purchase</i> which in return influenced the <i>actual purchase</i> in Internet shopping. <i>Intention to repurchase</i> was predicted by satisfaction, customer loyalty, perceived incentives, and actual purchase in Internet shopping.
2	(Baker-Eveleth & Stone, 2015)	<i>Efficiency</i> and <i>effectiveness</i> significantly influenced e-textbook usability. <i>Continuance intention</i> was directly influenced by <i>satisfaction</i> and perceived usefulness. <i>Usability</i> and expectation confirmation indirectly impacted continuous intention through satisfaction and perceived usefulness.
3	(Daghan & Akkoyunlu, 2016)	The strongest predictor effect on <i>continuance intention</i> was <i>satisfaction</i> . The relationship between continuance intention and <i>perceived usability</i> was also significant.
4	(Eveleth et al., 2015)	Usability dimensions <i>engagement</i> , <i>content</i> and <i>feedback</i> indirectly influenced users' <i>behavioural intentions</i> through website <i>usability</i> to website perceived usefulness, expectation-confirmation after website use and <i>satisfaction</i> . All in-between relationships were also statistically significant.

5	(Gelderblom et al., 2019)	<i>Satisfaction</i> and <i>continuance use intention</i> towards e-textbook platform are influenced by the <i>usability</i> of the system, users' expectations of the system, users' skills to adjust to the system or their own needs, users' attitude towards the system.
6	(Gupta et al., 2020)	Strong antecedents of the user's <i>continuance intention</i> were <i>satisfaction</i> , post-adoption self-efficacy and post-adoption perceived usefulness. An important enabler of the post-adoption perceived usefulness and self-efficacy was <i>perceived user interface quality</i> (it represents overall usability in terms of ease of use, navigational, visual, kinaesthetic and informational design).
7	(Hong et al., 2006)	<i>Perceived ease of use</i> , perceived usefulness and <i>satisfaction</i> had a strong direct effect on <i>continued IT usage intention</i> . Perceived ease of use (related to usability concept) had a direct positive impact on satisfaction and perceived usefulness did not.
8	(Najmul Islam et al., 2017)	<i>Perceived usability</i> , <i>usability confirmation</i> , perceived usefulness, and usefulness confirmation impacted user <i>satisfaction</i> with professional social networking site. Perceived usability along with satisfaction predicted <i>continuance intention</i> and perceived usefulness did not affect it.
9	(K. H. Kim et al., 2019)	Content quality, privacy, reliability and <i>usability</i> had an insignificant impact on <i>continuance intention</i> , whereas engagement had a significant effect. Content quality, engagement and reliability had a significant impact on <i>satisfaction</i> , which in return, had a significant effect on continuous intention. Satisfaction had an insignificant relationship with usability and privacy.
10	(Lim et al., 2019)	Internal (epistemic and attitudes) and functional (price, quality, attribute and <i>usability</i>) values highly influenced satisfaction. In a narrower sense, quality and usability strongly supported satisfaction whereas price and attribute supported it partially. <i>Satisfaction</i> is a significant predictor of <i>online repurchase intention</i> .
11	(Nascimento et al., 2018)	<i>Satisfaction</i> is significantly impacted by <i>perceived usability</i> , perceived enjoyment, confirmation and perceived usefulness. Habit, perceived usefulness and satisfaction had a significant effect on <i>continuance intention</i> whereas perceived enjoyment did not. Theoretically, habit, perceived enjoyment and perceived usability increased the predictive power in explaining the continuance intention.
12	(Oghuma et al., 2016)	Perceived service quality and <i>perceived usability</i> significantly impacted user <i>satisfaction</i> and <i>continuance intention</i> . Perceived service quality influenced confirmation, which in turns affected perceived usability and perceived security. The effect of perceived security on user satisfaction was not significant.
13	(Pee et al., 2018)	<i>Website usability</i> has a direct and significant effect on <i>repurchase intention</i> and service quality expectation (e.g., the relationship was stronger in cases when shoppers had less experience with online shopping and there were high-risk purchases). Repurchase intention was significantly impacted by <i>satisfaction</i> .
14	(Rizana & Govindaraju, 2016)	Benefit (decision-making improvement, task innovation, and productivity improvement), and sacrifice dimension (psychological cost) significantly influenced the utilitarian value of system usage. The utilitarian value (represented user assessment of value, benefit and usability of the system) had a significant impact on continuance intention.
15	(Tan et al., 2018)	Although, five out of seven <i>usability</i> constructs had a significant relationship with the <i>continuance intention</i> , only app utility, app dependability and UI output had a positive influence on it.

Note: Key findings are mostly referenced to usability-satisfaction-continuance intention relationship. These constructs are marked in italics.

The earliest study that extended ECM with one or more usability constructs dates to 2006, after which the number of articles dealing with this topic varied, which may be due to the following factors:

- The thesis candidate was not able to identify the main framework on which the study was based because the mixture of terms is used for ECM (e.g. ‘ECT’, ‘continuance intention model’, ‘IS continuance’); this issue is also recognized by Nabavi et al. (2016)
- The issue of continuance use intention in IS research; the importance of studying user behaviour after the initial experience of IS use is not yet sufficiently recognized by researchers
- System usability is mostly examined within “older” and well-known theoretical frameworks such as TAM, UTAUT and IS Success Model.

Therefore, this thesis should fill the identified gaps in understanding the role of usability in ECM.

Studies identified in Table 2 present the achievement of the first research objective RO1.

3 RESEARCH MODEL AND HYPOTHESES

This chapter presents the development of a research model (referred also as **usability-extended ECM**) designed to examine users' continuance intention to use an educational system for acquisition and evaluation of digital competences (DC) based on the Expectation-Confirmation Model (ECM) (Bhattacharjee, 2001) and usability. In the model, the usability is decomposed into perceived effectiveness, perceived efficiency and satisfaction (Bevan et al., 2016; ISO 9241-11, 2018). Since satisfaction already exists within ECM, it is only theoretically extended. In total, there are six variables in the model which are operationalized as a ground for identification and adaption of items found in literature, and later, to help experts in their decision-making processes during scale development (see [4.3 Instrument Development](#)).

Drawing on the background of reviewed literature, four hypotheses are established in the research model. The first two hypotheses propose satisfaction as a mediator between perceived effectiveness and continuance intention, and perceived efficiency and continuance intention. The other two hypotheses are related to the level of computer skill and duration of use as moderators between the satisfaction and continuance intention to use the system for acquisition and evaluation of DC. The latter system represents the research context to which the research model is applied and is discussed to a broader extent in the last part of this chapter.

3.1 Construction of Research Model

The expectation-confirmation framework is extensively used by scholars to explain behaviours as purchase, trust, satisfaction or switching decisions, but also the use, acceptance or adoption of technology (Bhattacharjee & Premkumar, 2004; Eveleth et al., 2015; Halilovic & Cicic, 2013). When applied to users' continuance intention, for example, the ECM (Bhattacharjee, 2001) suggests that users build their intention primarily on perceived usefulness of the information system (IS). The feedback they would receive after some period of IS use would reveal to them whether their expectations are confirmed. This would influence satisfaction and perceived usefulness which, in return, would affect their continuance intention to use. These relationships are mostly

hypothesized and confirmed in the ECM literature and serve to predict users' attitude toward the IS after the prior experience.

Found studies examine both indirect (Bagci & Celik, 2018; Baker-Eveleth & Stone, 2015; Chiu et al., 2005; Eveleth et al., 2015; K. H. Kim et al., 2019; Nascimento et al., 2018) and direct (Belanche et al., 2012; Daghan & Akkoyunlu, 2016; Najmul Islam et al., 2017; Oghuma et al., 2016; Pee et al., 2018) relationships between usability and continuance intention. The indirect relationship is often studied through the satisfaction variable. Regarding the indirect relationship, for example, Chiu et al. (2005) suggest that determinants of satisfaction can be shaped through usability. Moreover, the performed literature review found that usability is considered one of the key variables for predicting continuance intention and long-term use of IS (Atchariyachanvanich et al., 2007; Najmul Islam et al., 2017; Oghuma et al., 2016). Hence, it is worthwhile to extend the ECM with usability to examine users' continuance intentions toward the IS, such as the system for acquisition and evaluation of DC (see [3.3 Research Context](#)).

Typically, usability studies are conducted in a controlled laboratory environment where distractions are minimized to maintain a rigorous methodology (Coursaris et al., 2012). However, some distractions are expected in natural settings and therefore this thesis should have greater external validity of research findings (Coursaris et al., 2012). As Federici and Borsci state: “...usability is not only connected to the technological aspects of a machine's functions but also it pertains to the cognitive and functional aspects of a person's individuality” (Federici & Borsci, 2010, p. 2). Therefore, the subjective usability should be measured by attitude scales in surveys which have to be adapted to system features (Sousa et al., 2015). To reflect the subjective part of measuring usability, the ECM is extended with so-called **Perceived usability** defined as an “*extent to which a system, product or service can be used by specified users to achieve specified goals with effectiveness, efficiency and satisfaction in a specified context of use*” (Bevan et al., 2016, p. 269; ISO 9241-11, 2018).

As noted during the literature review, usability was measured with only one, but also three and more variables. To properly reflect the usability multidimensionality (Weinerth et al., 2014), it was decided to use more than one variable for its measurement. The most appropriate division of usability is found in ISO 9241 (2018), supported by Bevan et al. (2016), because it is international,

and generally accepted by researchers (Baker-Eveleth & Stone, 2015; Calero et al., 2010; Coursaris et al., 2012; Gelderblom et al., 2019). Thus, Perceived usability is divided into **Perceived effectiveness, Perceived efficiency and Satisfaction**. Effectiveness and efficiency are considered utilitarian or cognitive measures, while satisfaction is an affective measure (Coursaris et al., 2012). The first two variables were incorporated in the ECM and were added the term “perceived” for the same reason as usability to reflect the subjective part of measuring usability in the proposed model. Satisfaction was already a part of ECM and is only theoretically extended. Other variables that make the research model (referred also as **usability-extended ECM**) and are also part of the original ECM are (Bhattacharjee, 2001): **Confirmation, Perceived usefulness and IS continuance intention**. The final usability-extended ECM consists of six variables (see Figure 5 in the following sub-chapter). Their operational definitions (see Table 4) are adapted to the context of the system for acquisition and evaluation of DC (the *CRISS platform*) which users are primary and secondary school teachers.

Table 4. Operational definitions of constructs

Construct	Operational definition	References
Perceived effectiveness (PFE)	<i>Teachers’ perception of accuracy, completeness and lack of negative consequences with they achieve the specific goals in the CRISS platform.</i>	Adapted from (Bevan et al., 2016; ISO 9241-11, 2018)
Perceived efficiency (PFI)	<i>Teachers’ perception of resource consumption (e.g. time, mental or physical effort) in relation to the accuracy and completeness with they achieve the specific goals in the CRISS platform.</i>	Adapted from (Bevan et al., 2016; ISO 9241-11, 2018)
IS continuance intention (CI)	<i>Teachers’ intention to continue using the CRISS platform after its initial acceptance.</i>	Adapted from (Bhattacharjee, 2001)
Satisfaction (SAT)	<i>Teachers’ positive attitudes, emotions and comfort resulting from their use of the CRISS platform.</i>	Adapted from (Bevan et al., 2016; ISO 9241-11, 2018)
Perceived usefulness (PU)	<i>Teachers’ perception of the expected benefits of using the CRISS platform.</i>	Adapted from (Bhattacharjee, 2001)
Confirmation (CON)	<i>Teachers’ perception of the compatibility between the expectation of using the CRISS platform and its actual performance.</i>	Adapted from (Bhattacharjee, 2001)

3.2 Hypotheses Development

This sub-chapter presents the **development of four hypotheses** for the previously proposed usability-extended ECM, established on the existing knowledge and identified gaps in the literature

of IS and HCI. The proposed model is adapted to the research context of systems for acquisition and evaluation of DC (the CRISS platform). The literature review shows that studies have used a similar research model, but in other educational systems, such as e-textbook platforms (Baker-Eveleth & Stone, 2015; Gelderblom et al., 2019) and online learning environment (Daghan & Akkoyunlu, 2016). More examples of the application of a similar research model have been found in the business contexts such as online shops (Atchariyachanvanich et al., 2007; Pee et al., 2018), mobile services (K. H. Kim et al., 2019; Oghuma et al., 2016), wearables (Nascimento et al., 2018), etc. Given the limited number of studies identified to use a similar research model in the domain of education, findings from a business context were also used to support the development of hypotheses.

It was found a significant relationship between **perceived usability and continuance intention** in the context of an online learning environment (Daghan & Akkoyunlu, 2016), e-commerce (Sahi & Madan, 2013), professional social networking site (Najmul Islam et al., 2017), mobile instant messaging (Oghuma et al., 2016), online shopping (Pee et al., 2018), and others. It was also shown that **usability impacts satisfaction significantly** which in return influences continuance intention towards e-textbooks (Baker-Eveleth & Stone, 2015), websites for job-seekers (Eveleth et al., 2015), e-learning (Roca et al., 2006), online store (Belanche et al., 2012), and other.

However, by testing the correlations between **effectiveness, efficiency and satisfaction** in relation to usability, an appropriate level of discriminant validity was found (FrØkjaer et al., 2000). Therefore, it was concluded that all three variables should be included in the examination of usability unless the research domain specifies otherwise, which was not the case here. The relationships between cognitive measures (effectiveness, efficiency) and satisfaction were often the subject of usability analysis (Coursaris & Van Osch, 2016). Moreover, studies have shown **direct impacts of effectiveness and efficiency on satisfaction** (Churchill & Surprenant, 1982; Coursaris et al., 2012; Coursaris & Van Osch, 2016; Tse & Wilton, 1988). On the other hand, Baker-Eveleth and Stone (2015) found **indirect impacts of effectiveness and efficiency through satisfaction on continuance intentions** towards e-textbook. In the study of mobile devices, Coursaris et al. (2012) found a significant relationship between behavioural intention and satisfaction with efficiency, while satisfaction with effectiveness was insignificant. The corresponding hypotheses are developed based on the above findings as following:

H1. *Satisfaction mediates the relationship between perceived effectiveness and continuance intention to use the system for acquisition and evaluation of digital competences.*

H2. *Satisfaction mediates the relationship between perceived efficiency and continuance intention to use the system for acquisition and evaluation of digital competences.*

According to Braak et al. (2004), there is a general division of how computers are used by teachers. The first one is predominantly ineffective, i.e. a computer has a “supporting” role (e.g. helps teachers to prepare for the class), and the second is the active role of computers as educational resources in the teaching process. Recent research shows that teachers are less likely to practice active use of computers with their classes despite the advanced ICT infrastructure, which may be because they most often develop their computer skills in their free time and less often as a part of compulsory education or ICT training (European Commission, 2019; Gil-Flores et al., 2017). Nevertheless, teachers’ interest in active involvement with ICT is also related to e.g. experience, age, gender, skill, attitude towards ICT (Baş et al., 2016; Scherer et al., 2015; Tondeur et al., 2008; Wong & Li, 2008) etc. Furthermore, some research reveals that teachers are reluctant to use computers in a classroom unless they feel comfortable using the technology (Ross et al., 2001). When it comes to developing any technology, Shneiderman points out the shortcoming of this process: “*Designing for experienced frequent users is difficult enough, but designing for a broad audience of unskilled users is a far greater challenge*” (Shneiderman, 2000, p. 85). Especially since any failed attempt to use a particular system will result in anxiety and frustration of users (Shneiderman, 2000).

On the other hand, teachers with relatively good computer skills are more optimistic about integrating ICT in class than teachers with poor computer skills (Howie & Bignaut, 2009). Furthermore, teachers who have many years of experience using computers will use them more often in their work to perform various tasks (Tondeur et al., 2008). Frequency of use (or past behaviour) may indicate that users have created a habit which is “*...formed when using the same behaviour frequently and consistently in a similar context for the same purpose*” (Danner et al., 2008, p. 245). A habit has shown to be a very important determinant in explaining continuous intention; the more a person repeats an action or uses a certain technology, the greater the intention to do so in the future (Danner et al., 2008; Nascimento et al., 2018). In short, future behaviour can

be directly impacted by the frequency of past behaviour (Ouellette & Wood, 1998). Given the findings, the last two hypotheses are established as follows:

H3. *Level of computer skill moderates the relationship between satisfaction and continuance intention to use the system for acquisition and evaluation of digital competences.*

H4. *Duration of use (number of hours per week) moderates the relationship between satisfaction and continuance intention to use the system for acquisition and evaluation of digital competences.*

The developed research model and hypotheses are provided in Figure 5, thus the second research objective RO₂ is reached.

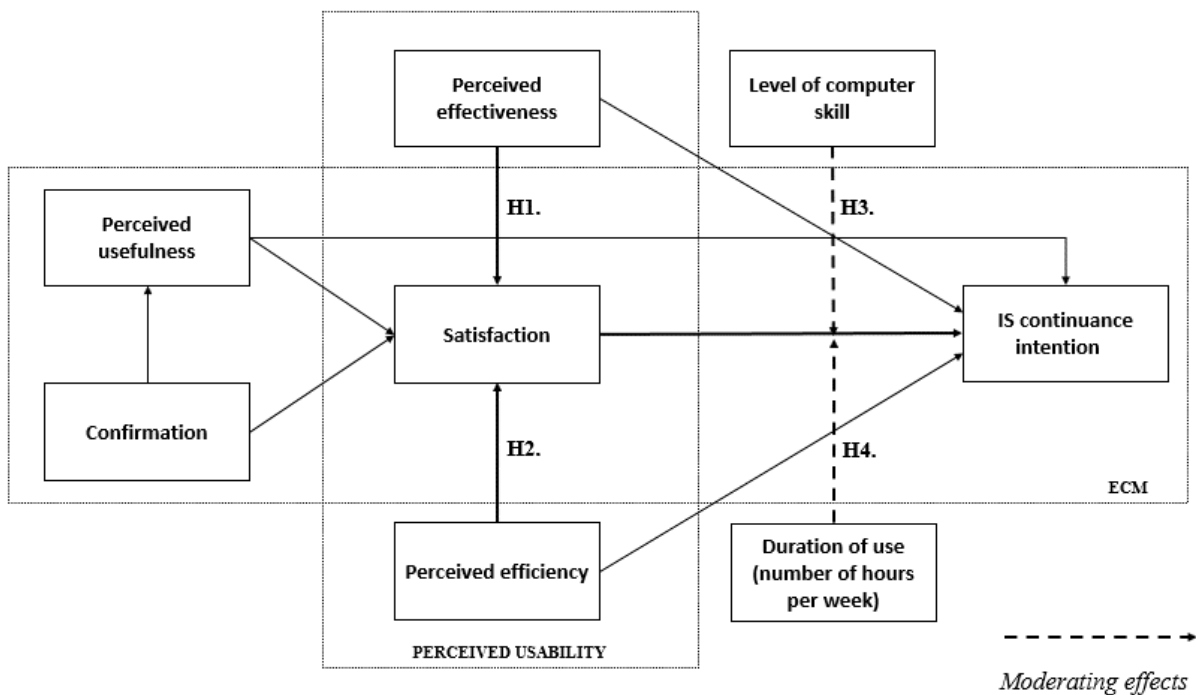

Figure 5. Research model (usability-extended ECM) and hypotheses

3.3 Research Context

The importance of the first IS use (acceptance) is an essential determinant of its success that has been long recognized in the marketing and IS literature (Kwon & Wen, 2010). However, users' interest in adopting IS after they have had an actual experience of use is changing, therefore, the

research on continuance intention in IS has become crucial (Bhattacharjee, 2001; Bhattacharjee & Barfar, 2011; Karahanna et al., 1999).

One of the IS suitable for conducting the research is certainly **the CRISS platform**, developed within the CRISS project funded under Horizon 2020 Call - Information and Communication Technologies (H2020-ICT2016-2017). The primary aim of the CRISS project was the *“demonstration of a scalable and cost-effective cloud-based digital learning infrastructure through the certification of digital competences in primary and secondary schools”* (Guárdia et al., 2017, p. 77). Due to the European Commission’s efforts to promote various initiatives toward increasing the education of digital skills of citizens, the project partners (consortium) found themselves able to contribute with the proposal. Therefore, the CRISS consortium proposed an innovative learning and teaching platform based on the most advanced pedagogical methodologies and technological solutions.

The CRISS platform is **a modular cloud system for acquisition and evaluation of DC**, based on a new methodological framework that is consisted of five areas (digital citizenship, communication and collaboration, searching for and managing information, digital content creation, and digital problem solving), 12 sub-competences, and corresponding 37 performance criteria and indicators. The framework was created as a result of the analysis of the Digital Competence Framework for Citizens (DigComp 2.1), but also other relevant frameworks related to the student population (Balaban et al., 2019).

The platform enables teachers to monitor and evaluate the DC of their students through various interdisciplinary problem situations, namely competence assessment scenarios (CAS) that can present one or more subjects or learning projects (Guárdia et al., 2017). The CAS consists of a set of activities and tasks that are defined and assessed by teachers in relation to one or more set performance criteria and indicators. Each student should be able to produce certain evidence to each task within the platform in order to successfully attain an individual sub-competence.

Due to the modularity and scalability of the platform, it is applicable to both formal school curricula (regardless of their organisational structure and syllabi) and non-formal educational contexts (e.g., vocational training). With respect to technical details, the platform is designed in two main parts: the CRISS Core and the CRISS Certification and Learning Analytics (see Figure 6). Different

modules, sub-modules, components and elements can be plugged in or unplugged from the CRISS Core which comprises four modules that allow users (both teachers and students) to work and perform their tasks:

- Module 1 – *ICT Manager Tool* allows user management, activities planning and assessment.
- Module 2 – *ICT Tools Set* allows users to create unique content.
- Module 3 – *ePortfolio* showcases students’ progress and assessments.
- Module 4 – *ICT Dynamic Profile* provides a profile of each student.

Within the Certification and Learning Analytics (LA) part, CRISS Platform distinguishes three modules:

- Module 5 - *Certification of Digital Competence*
- Module 6 - *Learning Analytics* which provides insights useful for the certification and personalization of the learning process.
- Module 7 – *Adaptive Intelligent Tutoring System* which infers adequate actions meant to fill the learning gaps in achieving a specific sub-competence.

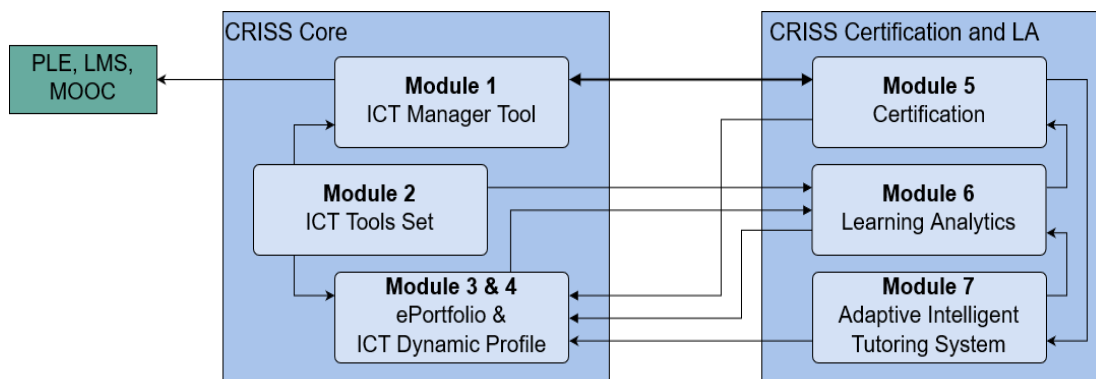

Figure 6. A high-level overview of the CRISS platform

The CRISS platform was piloted during 2019 in 57 primary and 77 secondary schools across six European countries - Croatia, Greece, Italy, Romania, Spain and Sweden. Selected schools have introduced the platform into regular teaching and learning activities of several subjects and their teachers who were willing to participate in the project. Since being used by young learners and their teachers, the interface of the CRISS platform has been translated into target languages as well

as scenarios, tasks and activities that were also further adapted to fit the country-specific context and to fit different educational levels (primary or secondary).

Upon the completion of the project, it has been planned to commercialize the platform, therefore it is necessary to check whether there exist users who will have the intention to use it in the future. Research findings (Cordero & Mory, 2019; Scherer et al., 2019) suggest that teachers should be responsible for the incorporation of DC acquisition and evaluation into schools. Therefore, the undertaken research has focused on teachers' perception and attitude towards the implementation of the platform that would support students' DC acquisition and evaluation.

Moreover, the platform is a part of a growing trend aiming to reduce the digital divide in society and provide transparency of individual's DC in the labour market. The findings indicate that DC acquisition and evaluation should be started very early in primary schools (Casillas Martín et al., 2019; Siddiq et al., 2017; Zobotkina et al., 2019) and it should be integrated into the formal educational curriculum (Tudor, 2018; Varela et al., 2019). This approach would enable schools to identify a lack of a specific DC and introduce a plan for their implementation. It can be concluded that results obtained from the analysis of the proposed research model in the context of the CRISS platform will contribute to the general knowledge of systems for acquisition and evaluation of DC and reveal their sustainability in the future. Additionally, the literature review identified similar systems that follow the DigComp framework and are focused on the evaluation of one or more components of DC, such as (Kluzer & Pujol Priego, 2018): the Digital Literacy Barometer of Anglia Ruskin University¹, BAIT of Basque Government², TASK under the ERASMUS+ Programme³, TuCertiCyL of Junta de Castilla y León⁴, PIX of French Ministry of Education⁵, etc.

¹ Audit tool for students and faculty staff. More information can be found at: <https://aru.ac.uk/anglia-learning-and-teaching/good-teaching-practice-and-innovation/technology-enhanced-learning-and-teaching/digital-literacy>

² Digital competence certification system for citizens. More information can be found at: <https://ikanos.eus/en/>

³ Digital tool for assessment and certification of students in secondary schools. More information can be found at: <http://www.taskeuproject.com/>

⁴ Digital competence certification system for citizens. More information can be found at: <https://tucerticyl.es/>

⁵ Online platform for digital skills evaluation and certification for citizens. More information can be found at: <https://pix.fr/en-gb/>

These systems have been developed for different environments from formal education and training to employment and life-long learning targeting different groups of users. Development of systems with a similar scope can be further expected since there is an increasing need for them (Bartolomé et al., 2021).

4 RESEARCH METHODOLOGY

This chapter thoroughly explains the research methodology used to achieve research objectives. It begins with a description of the applied research design and each layer of the research “onion”. The positivist philosophy and deductive approach explained here guided the thesis candidate through the development of the research model and formulation of the hypotheses from the previous chapter. This is followed by the argumentation of the use of sequential mixed methods in research design and the implementation of a survey strategy in data collection. Decision on the choice of the cross-sectional time horizon in research and the sampling design was also discussed. The chapter concludes with the development of the instrument through three phases and the legal and ethical considerations that needed to be taken into account during the collection of data from the respondents.

4.1 Research Design

A research design is selected with regard to a defined research question and objectives, and presented in this sub-chapter according to the **research “onion”** consisting of six layers listed from the outside to the inside as follows (Saunders et al., 2016): **philosophy, approach, methodological choice, strategy, time horizon, techniques and procedures.**

The following sub-chapter 4.1.1 is concerned with the first two outer layers of the “onion” - philosophy and approach to theory development. In sub-chapter 4.1.2 it is examined the methodological choice and strategy for data collection. The fifth layer, the time horizon is discussed in sub-chapter 4.1.3. The last and central part of research “onion” consists of techniques and procedures that are related to sampling design (sub-chapter 4.2) and instrument development (sub-chapter 4.3), followed by data analysis and results in the following chapter 5.

As shown in Figure 7, a thoroughly planned research design has ensured coherence in the conducted research process. The figure also presents what has been achieved by implementing each of these layers, while the aforementioned (sub-) chapters discuss how this has been achieved (Saunders et al., 2016).

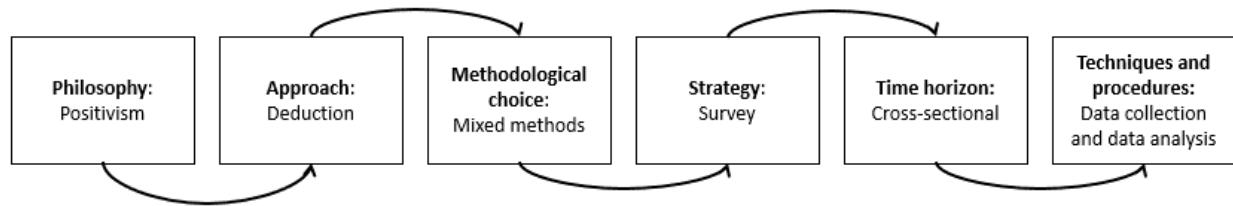

Figure 7. Research design (Saunders et al., 2016, p. 164)

4.1.1 Research Philosophy and Approach

Positivism and deduction are considered a suitable philosophy and approach for conducting the thesis research considering its nature and the worldview of the thesis candidate (Creswell, 2014). The applied **deductive approach** is one of three main ways of developing the theory (Saunders et al., 2016). This approach is “*based on a general idea in order to reach the specific situation, and is to come up with a hypothesis using a certain theory, and is linked with the positivist paradigm*” (Hussain & Khuddro, 2016, p. 20). The process of deductive research is divided into three main steps applied as follows (Lancaster, 2005):

- (1) **Formulation:** Four hypotheses are formulated based on the literature review (see [3.2 Hypotheses Development](#))
- (2) **Operationalization:** Operational definitions of six constructs were established within usability-extended ECM considering the context of the CRISS platform (see [3.1 Construction of Research Model](#))
- (3) **Theory testing:** The proposed hypotheses were tested by using empirical data collected from primary and secondary school teachers with the aid of a developed survey instrument (see [4.3 Instrument Development](#)). The empirical data supported hypotheses H₁ and H₂ and refuted hypotheses H₃ and H₄ (see [5.5 Structural Model Assessment](#)). Although the supported hypotheses are not considered proven, they have a high measure of corroboration.

Simply stated, a deductive approach led to developing a research model based on existing theory and testing its adequacy in explaining the obtained findings (Saunders et al., 2016). This approach is often underpinned by **positivist research philosophy** oriented towards “*sensory experience (empiricism), observational description (e.g. ruling our inferences about actors’ intentions, thoughts or attitudes), operationalism, ‘methodical control’, measurement, hypothesis testing and*

replicability through the specification of explicit and transparent procedures for conducting research” (Cohen et al., 2018, p. 10).

The positivist approach of the thesis candidate reflects her neutral and value-free perspective of conducting a quantitative data collection procedure using the survey instrument where respondents choose from a predetermined range of responses and are not asked questions in person. The structured methodology followed during the research is replicable which is also a characteristic of applied positivism (Saunders et al., 2016).

4.1.2 Methodological Choice and Strategy

The intention is to determine the extent to which perceived usability impacts users' continuance intention to use the system for acquisition and evaluation of digital competences (DC) within primary and secondary education. The **sequential mixed methods** (Creswell, 2014; Saunders et al., 2016) fit the aim of the thesis and therefore were utilized in the research design through a four-phase procedure. Qualitative and quantitative methods were applied sequentially as follows:

- **Phase 1 (Qualitative):** A comprehensive **literature review** was conducted between September and December 2020 to identify studies that have applied one or more constructs of ECM (Bhattacharjee, 2001) and usability within their research model to ensure a solid foundation for meeting the research objectives of this thesis.
- **Phase 2 (Quantitative):** Eleven **experts** were sent the scales' items to quantify the content validity of an instrument. They had to assess the relevance of each item for a given scale with “1 – Not necessary, 2 – Important, but not essential, and 3 – Essential”. Items identified as “not necessary” were eliminated from the instrument.
- **Phase 3 (Qualitative):** Four **focus groups** were held to qualitatively improve the content of a measurement instrument that was previously developed based on the conducted literature review and experts' ratings (from previous Phase 2). The thesis candidate opted for the focus group method because more information can be obtained in a shorter timeframe than it can be done in a one-on-one setting (e.g. interview) (O'Brien, 1993). Focus groups are especially valuable to identify relevant constructs and to abandon the irrelevant, and help the researchers to improve their communication with the target

respondents (Fuller et al., 1993). In this case, focus groups were used to improve the instrument content in terms of clarity and comprehensiveness. This was achieved by rewording the misleading items or dismissing the irrelevant items. This method also ensures the content validity of an instrument in a qualitative sense.

- **Phase 4 (Quantitative):** Revised survey instrument was **pre-tested** with several teachers before conducting the full-scale testing because focus groups are not considered an appropriate substitution for it (Saunders et al., 2016). During the **full-scale testing**, the survey was administered for collecting quantitative data from primary and secondary school teachers in six European countries. Collected data were used to test the proposed research model.

For developing a good psychometric instrument it was necessary to use different samples for the qualitative and quantitative phases of research (Saunders et al., 2016). All methods in a four-phase procedure were applied **sequentially** which means that the result of each method was the input for the next one. Nevertheless, the thesis is considered dominantly quantitative but supported with qualitative results from focus groups.

The choice of research strategies is driven by a proposed research question and defined objectives to create coherence throughout the design (Saunders et al., 2016). The **survey strategy** using the questionnaire was employed to collect the data from primary and secondary school teachers on their attitudes towards the CRISS platform. This type of research strategy is often linked with a deductive approach which is already explained. The acquired quantitative data is subjected to descriptive and inferential statistical analysis. Before the implementation of the survey strategy, focus groups and experts' assessments were used only as research aids in the instrument development phase.

4.1.3 Time Horizon

The research undertaken within this thesis established the **cross-sectional time horizon** as the time for the data collection was limited. Thus, it was necessary to obtain the “snapshot” of targeted phenomena at a certain point in time (Saunders et al., 2016). This was done by employing the survey strategy among primary and secondary school teachers in the period between 29 April and 30 June 2019 (the process is described in the *Full-Scale Testing* part of [4.3.3 Instrument Testing](#)).

The phenomena of interest for the research were their continuance intention to use the CRISS platform in the future. The research could not be conducted over a longer period of time, because the development of the CRISS platform was delayed for the penultimate year of project implementation (2018). Therefore, its use by teachers was shifted for the final year of the project (2019). Consequently, teachers used the platform for a limited time during which the collection of data had to be organised. The thesis candidate decided to administer the survey to all teachers who used the platform and thus get a “snapshot” of attitudes and opinions related to their continuance intention of its use.

4.2 Sampling Design

The sampling process was executed once the target population, sampling frame, sampling design and sample size were determined (Sekaran & Bougie, 2016). In this thesis, the **target population** was **primary and secondary school teachers** in six European countries (Croatia, Greece, Italy, Romania, Spain and Sweden) who participated in EU project CRISS from 2017 to 2019 and registered in the CRISS platform. Schools of those teachers were carefully selected on behalf of each partner regarding the established guidelines targeting diversities, such as:

- A school can be of different size regarding the number of students
- A school can be private or public
- A school can be located in an urban or rural area
- Any type of secondary education can be selected (vocational, scientific, technical, lyceums, etc.).

The registry of each project partner represented the **sampling frame** for this survey research because it contained a listing of all participating teachers. Since each project partner was responsible for the communication with primary and secondary schools in their country, the thesis candidate collected teachers’ email addresses with their help. Project partners have contacted **57 headmasters of primary and 77 headmasters of secondary schools** asking for permission to distribute email addresses of their teachers to a thesis candidate for her survey research. Headmasters were explained in advance about the personal data protection of the included teachers.

It was also emphasized to them that the **participation of their teachers would be anonymous and voluntarily**.

The fact is that the CRISS platform was one of the first attempts to apply DC to formal learning and teaching processes, and teachers who used it were the only ones who could provide relevant information. Therefore, **judgement sampling** as a nonprobability technique was applied to achieve the maximum response rate possible since a limited number of people had the information that was sought (Sekaran & Bougie, 2016). Although the generalizability of all nonprobability sampling techniques is often the subject of a debate, in this case, teachers' "...*opinions, views, and knowledge constitute a rich data source*" (Sekaran & Bougie, 2016, p. 248) and they were the only one available at a given time.

The total **sample size** was 1.102 primary and secondary school teachers. Despite the large sample size, efforts were made to ensure that the response rate was at least ten times higher than the number of items, thus increasing the representativeness of the sample (Hair et al., 2017). This has also helped to achieve greater assessment credibility of the proposed research model (Chao et al., 2016; Daramola et al., 2017). Measures taken to reduce the low response rate are described in the *Full-Scale Testing* part of 4.3.3 Instrument Testing.

4.3 Instrument Development

The development of the instrument was performed in three stages **to properly address the third research objective (RO₃) as follows** (Moore & Benbasat, 1991): (1) **Item creation**; (2) **Scale development**; and (3) **Instrument testing**. The purpose of developing the instrument through these stages was to establish its content validity referring to "*that the measure includes an adequate and representative set of items that tap the concept*" (Sekaran & Bougie, 2016, p. 221).

4.3.1 Item Creation

In the first stage of instrument development, the literature was reviewed to identify the existing instruments that were already validated in the field of IS and HCI. The items were extracted from the found instruments and then categorized according to previously developed operational definitions of constructs (see Table 4 in 3.1 Construction of Research Model). Once the initial set

of items were created, the thesis candidate re-evaluated them to remove those which appeared to be ambiguous or redundant on the scale. The **initial set of items consisted of 46 items** that were categorized as follows:

Perceived Effectiveness: 12 items	IS Continuance Intention: 5 items
Perceived Efficiency: 7 items	Perceived Usefulness: 7 items
Satisfaction: 12 items	Confirmation: 3 items

All items were adapted to suit the context of the CRISS platform (see [Appendix A: Initial Set of Items](#)). Each item was in a form of a statement to which the respondent had to indicate a degree of agreement. It was foreseen to use a five-point Likert scale ranging from “strongly agree” to “strongly disagree”, but it was left to a discussion with focus groups (see [4.3.2 Scale Development](#)).

4.3.2 Scale Development

The first stage, item creation was completed by creating an initial set of 46 categorized items that served as an input for this second stage - **scale development**, also referred to as a **judgement stage** according to Lynn (1986). Generally, it is suggested to involve at least three experts in the judgement of each scale item (Polit & Beck, 2006). Although a maximum number of experts has not been determined, it is predicted that with a larger number of experts there is also an increased risk of their disagreement on the relevance of certain items. On the other hand, with a smaller number of experts, one could not reach over the necessary 80% of agreement that can be frequently found in the literature (Newman et al., 2013). The selection criteria for a **panel of experts** are in line with Rubio et al. (2003) who recommend it should be composed of content experts who have worked or published in the field of research, and lay experts who belong to the target group of research. Selected experts had two commonalities - they work in the field of education and have participated in different activities of the CRISS project. The expertise of content experts was based on experience working on various projects related to instrument development, IS and usability research. Lay experts were teachers who have more than ten years of experience in teaching and use various ICT tools in education. Experts' data are shown in Table 5.

Table 5. Experts' data

No	Organisation	Gender	Occupation	Country	Experience (years)
1	CARNET (Croatian Academic and Research Network)	Female	Facilitator of projects	Croatia	IS research; Usability research; Instrument development (15 years)
2	Escola Pia De Catalunya (Educational organisation)	Male	Teacher	Spain	IS research; Usability research (13 years)
3	Escola Pia De Catalunya (Educational organisation)	Female	Teacher	Spain	Lay expert (17 years)
4	GDN (The Education Department of Navarra Government)	Female	Teacher	Spain	IS research; Instrument development (4 years)
5	GDN (The Education Department of Navarra Government)	Female	Teaching adviser	Spain	Usability research; Instrument development (5 years)
6	RDE (Regional Directorate of Primary and Secondary Education of Crete)	Female	Teacher	Greece	Lay expert (13 years)
7	RDE (Regional Directorate of Primary and Secondary Education of Crete)	Male	Teacher	Greece	Lay expert (11 years)
8	Colegiul „Mihai Viteazul” Ineu (Primary and secondary school)	Female	Teacher	Romania	Lay expert (21 years)
9	Scoala Gimnaziala Regina Maria Arad (Secondary school)	Female	Teacher	Romania	Lay expert (22 years)
10	HEA (Halsingland Education Association)	Male	Teacher	Sweden	Usability research; IS research (12 years)
11	UCL (University College London)	Female	Research associate	UK	Usability research; Instrument development (5 years)

The initial set of 46 items organized in a form of a table within an Excel document was sent via email to each expert on 15 January 2019. They had a deadline of two weeks to send the feedback. The task for them was to rate the importance of each item for a given construct following the suggestion from Ayre and Scally (2013): “1 – Not necessary, 2 – Important, but not essential, and 3 – Essential” for the context of the CRISS platform. Operational definitions were put for each construct to ease the decision-making process for experts. They could also add one or more items if they considered that some of the construct’s dimensions were left uncovered, and comment on each item regarding its appropriateness for the construct and comprehensiveness for target respondents. From their responses, a **content validity ratio (CVR)** was calculated for each item using Lawshe’s formula (Ayre & Scally, 2013):

$$CVR = \frac{(n_e - N/2)}{N/2}$$

N = total number of experts who participated in evaluation of items

n_e = number of experts who indicated an item '2 - Important, but not essential' or '3 - Essential'

In Lawshe’s formula n_e would originally represent the number of experts who indicated an item “essential”, but experts had rather diverse viewpoints of usability items which caused a necessity to use a less stringent calculation. Therefore, except for using the number of experts who indicated an item “3 – Essential”, the number of experts who indicated items “2 – Important, but not essential” was also involved. Later, it will become clear the rationale behind their ratings from their comments and during the discussion with focus groups. **Experts’ ratings of items based on their professional judgement** are quantitatively showed in Appendix B: Judgements of Experts (CVR). Computed CVR can range from -1 to +1. The minimum value of CVR should be at least .818 (or 80%) for each item to be included in the instrument or, in this case, at least nine out of 11 experts had to agree on the importance of a specific item (Ayre and Scally, 2013). Experts agreed on 28 items to be important for the domain, while 18 items they considered irrelevant. They also made their qualitative ratings in a form of comments that are shown as a part of the final set of items in Table 6. Many experts suggested moving item (12) from Perceived effectiveness to Perceived efficiency, and by that, it can be concluded that to some extent the construct validity is also tapped. It means they observed whether chosen items properly “*capture the essence of the construct*” (Straub & Gefen, 2004, p. 388). Two items were also suggested to be added to the Confirmation construct. This resulted in **a total of 30 items** that were used as a template for discussion with focus groups.

Table 6. A final set of items after experts’ judgments

Construct	No	Items	Summary of experts’ comments
Perceived effectiveness (6 ITEMS)	2	Using the CRISS platform helps overall in my teaching.	None.
	4	The CRISS platform is well organized.	None.
	6	<i>The CRISS platform suits my teaching style.</i>	Suggested modification of an item by experts.
	7	The CRISS platform capabilities meet my requirements.	None.
	8	<i>The CRISS platform allows me to perform the tasks I need to perform.</i>	Suggested modification of an item by experts.
	9	It is easy to complete tasks in the CRISS platform.	None.

Perceived efficiency (5 ITEMS)	1	The pages within the CRISS platform load quickly.	None.
	2	<i>The CRISS platform allows me to quickly perform the tasks I need to perform.</i>	Suggested modification of the “saves me time” part of the item because it was unclear.
	4	<i>It requires only a few clicks to locate the information in the CRISS platform.</i>	Suggested to replace “provides” with “requires only” to be more understandable to the teachers.
	5	It is easy to navigate through the CRISS platform.	None.
	*	<i>I can perform the task within the CRISS platform without any errors.</i>	Suggested to be removed from Perceived effectiveness and added to Perceived efficiency.
IS Continuance intention (4 ITEMS)	1	<i>I would continue using the CRISS platform even if I would be offered an alternative platform.</i>	Suggested modifications: “I would” instead of “My intentions are” and “even if I would be offered” instead of “rather than”. Experts considered this sentence structure more relatable for the teachers.
	3	<i>I would like to continue using the CRISS platform in the future.</i>	The same structure is applied here as in the previous item (1). Additionally, “after this class” was suggested to be replaced by “in the future” to make it more general, but to keep the point of what was intended to examine.
	4	I intend to continue using the CRISS platform to teach new digital competence in the future.	None.
	5	I intend to continue using the CRISS platform rather than discontinue its use.	None.
Satisfaction (5 ITEMS)	2	<i>I find CRISS platform enjoyable to use.</i>	Experts considered the platform was not developed to be fun, but rather to provide an enjoyable experience to its user while giving lectures. The modification was made in line with these observations.
	3	I would recommend the CRISS platform to another teacher.	None.
	5	I feel comfortable using the CRISS platform.	None.
	6	I am pleased with how the CRISS platform facilitates my teaching.	None.
	7	<i>I am satisfied with my use of the CRISS platform.</i>	The suggestion was to add “my use” and to keep the items as simple as possible, without adding the adverb “extremely”.

Perceived usefulness (6 ITEMS)	1	Using the CRISS platform makes it easier to communicate with others.	None.
	2	<i>Using the CRISS platform is beneficial for my teaching.</i>	Suggested to express it more clearly for what the platform is beneficial for.
	3	Using the CRISS platform increases my productivity in class.	None.
	4	Using the CRISS platform improves my performance in teaching.	None.
	5	Using the CRISS platform enhances my effectiveness in teaching.	None.
	7	The CRISS platform is useful for my teaching.	None.
Confirmation (4 ITEMS)	2	My experience with using the CRISS platform was better than what I expected.	None.
	3	<i>Overall, most of my expectations from using the CRISS platform were confirmed.</i>	Suggested to add the “overall” and put the statement in different verb tense.
	*	<i>Using the CRISS platform was easier to learn than what I expected.</i>	Suggested by the experts to be added.
	*	<i>CRISS platform had a simpler layout than what I expected.</i>	Suggested by the experts to be added.
Note:			
<ul style="list-style-type: none"> • Column No denotes the number of an item, originally set up during the generation of items in Appendix B. • Items in <i>italics</i> and with an expressed number on the left (No) are modified according to experts’ comments and considered essential (3) or important (2) for a domain. • Items in <i>italics</i> and with an asterisk (*) on the left (No) are newly added due to experts’ suggestions. 			

Focus groups consisted of different groups of experts that were employed to generate the final set of items (Straub & Gefen, 2004). Thus, the thesis candidate contacted project partners from Croatia and Spain who were responsible for the communication with schools to organize four group discussions with experts from at least two different countries. The recommendations and best practices from Guest et al. (2016), O’Brien (1993) and Fuller et al. (1993) were followed to conduct the focus groups.

The discussion outline was not strictly defined, but the thesis candidate opened each focus group by stating the purpose of the discussion and explaining the term “task” used in the items. During the focus groups, it was suggested to replace this term with the term “activity” which seemed to be more intuitive to teachers (respondents) and as such it was implemented in the survey. Each focus group revised each item individually aiming to improve the content of the instrument in terms of clarity and comprehensiveness. This was achieved by rewording the misleading items or dismissing

irrelevant items. **Four focus groups** were organized **at four locations** where six to eight participants discussed the proposed instrument items between 1,5 and 2 hours (see Table 7).

Table 7. Summary of focus groups

Focus group	Location	Date	Number of participants	Type of participants (Total number) - Country
1.	Faculty of Organization and Informatics, Varaždin (Croatia), <i>online</i> -Open University of Catalonia, Barcelona (Spain)	28/02/2019	6	Secondary school teachers (4) - <i>Croatia</i> ; Education expert (1) - <i>Spain</i> ; DC expert (1) - <i>Spain</i>
2.	Primary school Ivo Andrić, Zagreb (Croatia)	06/03/2019	6	Primary school teachers (4) – <i>Croatia</i> ; Education expert – <i>Croatia</i> (1); DC expert (1) – <i>Croatia</i>
3.	Primary school Horvati, Zagreb (Croatia)	15/03/2019	7	Primary school teachers (4) – <i>Croatia</i> ; Secondary school teachers (3) – <i>Croatia</i>
4.	Faculty of Organization and Informatics, Varaždin (Croatia), <i>online</i> -Open University of Catalonia, Barcelona (Spain)	21/03/2019	8	Primary school teachers (3) – <i>Spain</i> ; Secondary school teachers (3) – <i>Spain</i> ; Usability experts (2) – <i>Spain</i>

The thesis candidate gained insight into the phrases used by teachers based on discussions she participated in, which helped her to properly adapt the instrument to collect valid data. Focus groups were composed of:

- (1) Primary and secondary teachers working at different schools, but participating in the same ongoing CRISS project
- (2) Experts in the field of DC development
- (3) Education experts
- (4) Usability experts.

Due to logistics reasons and teaching schedules, it was not always possible to gather all participants physically and target teachers from different schools in the same round of a focus group. However, the mitigating circumstance was that it was not necessary to have difficult discussions in terms of illegal, immoral and similar issues which required heterogeneous groups (Fuller et al., 1993), but it was in the common interest of all participants to make the instrument as understandable as possible to the target group, teachers.

Three guided group discussions with a total of 19 participants were held physically in Croatia, while one was made online with eight teachers and experts from Spain. Altogether, 9 men and 18 women between the ages of 29 and 55 ($M=40.70$, $SD=6.63$) participated in the focus groups. The structure of the participants involved in the focus groups is shown in Table 8. There were 11 teachers from two Croatian and two Spanish primary schools, 10 teachers from three Croatian and two Spanish secondary schools, two usability experts from Spain, two education experts and two DC experts from Croatia and Spain. Scale development using focus groups was more focused on teachers which is acceptable because they are typical representatives of the target group being researched (Saunders et al., 2016). A total of 27 participants were voluntarily engaged in organized discussions during February and March 2019.

Table 8. Focus groups – participant structure

Type of participant	Croatia	Spain	Total
Secondary school teacher	7	3	10
Education expert	1	1	2
Primary school teacher	8	3	11
Usability expert	0	2	2
DC expert	1	1	2
<i>Total</i>	17	10	27

Teachers' suggestions were noted on behalf of the thesis candidate during the group discussions and qualitatively analysed later to improve the content validity of the instrument. Eight items were removed, and seven items were added due to the participants' suggestions during at least two conducted focus groups. Table 9 contains **29 items that were implemented in the final survey instrument** ready for the next stage - instrument testing.

Table 9. Set of items after focus groups (Final instrument)

Perceived Effectiveness (<i>removed No: 7, 9 – according to Table 6</i>)			
No	Code	Items	Summary of focus groups discussions
2	PFE1	CRISS platform helps me in teaching.	Minor modifications.
4	PFE2	CRISS platform is well organized.	None.
6	PFE3	CRISS platform suits my way of teaching.	Minor modifications.
8	PFE4	CRISS platform allows me to do a certain activity in the way I want it.	It was decided to replace “task” with “activity” because it was more comprehensive for the teachers.

	PFE5 (*)	The information provided on the CRISS platform is complete.	New. Theoretically grounded: (Quesenbery, 2003).
	PFE6 (*)	I can find an option on the CRISS platform without much trouble (e.g. for making a new plan, adding content to planning, setting the due date for task solving, checking the learning analytics, and similar).	New. It was suggested to add the part with the example (“e.g.”) to involve working practices in the CRISS platform. Theoretically grounded: (Finstad, 2010)
Perceived Efficiency (removed No: * – according to Table 6)			
No	Code	Items	Summary of focus groups discussions
1	PFI1	CRISS platform is fast (e.g. pages load quickly).	Minor modifications.
2	PFI2	CRISS platform allows me to quickly perform a certain activity.	Minor modifications.
	PFI3 (*)	It is easy to complete a certain activity in the CRISS platform.	New. Theoretically grounded: (Lewis, 1995)
	PFI4 (*)	It is easy to communicate through the CRISS platform.	New. Theoretically grounded: (Najmul Islam et al., 2017)
4	PFI5	I can quickly find the information I need in the CRISS platform.	Minor modifications.
5	PFI6	It is easy to navigate through the CRISS platform.	None.
	PFI7 (*)	It is easy to read the text (font size, type and colour) on the CRISS platform.	New. Theoretically grounded: (Baharum & Jaafar, 2015)
IS Continuance Intention (removed No: 4 – according to Table 6)			
No	Code	Items	Summary of focus groups discussions
1	CI1	I intend to continue using the <i>CRISS platform</i> together with traditional ways of teaching (e.g. pencil-paper tasks, *web application for checking grades, absences or notes written by teachers available for both students and their parents) <i>*This description can be replaced by any other web application used in your school.</i>	Major modifications. The preliminary item was ‘ <i>I would continue using the CRISS platform even if I would be offered an alternative platform</i> ’, but focus groups considered there is still no appropriate substitute developed instead of the CRISS platform.
3	CI2	I intend to continue using the <i>CRISS platform</i> frequently.	Minor modifications. Instead of “in the future”, it was suggested to use the term “frequently”.
5	CI3	I would like to continue using the <i>CRISS platform</i> rather than discontinue its use.	Minor modifications.
Satisfaction (removed No: 2 – according to Table 6)			
No	Code	Items	Summary of focus groups discussions
3	SAT1	I would recommend the CRISS platform to other teachers.	Minor modifications.
5	SAT2	I like using the CRISS platform.	Major modifications. Instead of “feel comfortable” use “like”.
7	SAT3	I am satisfied with my use of the CRISS platform.	None.
6	SAT4	I am pleased with how the CRISS platform facilitates my teaching.	None.
Perceived Usefulness (removed No: 1, 3 – according to Table 6)			
No	Code	Items	Summary of focus groups discussions
4	PU1	CRISS platform helps me to teach faster.	Major modifications.
5	PU2	CRISS platform helps me to achieve better results in teaching.	Major modifications.

7	PU3	CRISS platform is useful for teaching.	Minor modifications.
2	PU4	CRISS platform has more advantages than disadvantages.	Major modifications.
Confirmation (removed No: 2 – according to Table 6) (*The scale was refined as: “1-Far below my expectations; 2-Somewhat below my expectations; 3-In line with my expectations; 4-Somewhat over my expectations; 5-Far beyond my expectations” due to the suggestions of conducted focus groups)			
No	Code	Items	Summary of focus groups discussions
3	CON1	CRISS platform has met all my expectations.	None.
*	CON2	The layout of the CRISS platform has met my expectations.	Minor modifications.
*	CON3	CRISS platform is easy to use as I expected.	Minor modifications.
	CON4 (*)	Through the CRISS platform, I taught as fast as I expected.	New. Theoretically grounded: (Bhattacharjee et al., 2008)
	CON5 (*)	CRISS platform helped me to track the progress of my students as I expected.	New. Theoretically grounded: (Bhattacharjee et al., 2008)
Note:			
<ul style="list-style-type: none"> • Column No denotes the number of an item, originally set up during the generation of items (see Appendix B); after, it was modified in Table 6. • Given the suggestions of teachers and experts, certain items were removed and those are listed <i>in italics</i> for each construct according to column No from Table 6. • The column ‘Code’ is referenced to the new coded name of each item, and asterisk (*) items were added as new ones. • The column ‘Summary of focus group discussions’ indicates whether an item: (1) was modified to a major or a minor extent (Minor modifications/Major modifications); (2) was not modified at all (None.); or (3) was newly added due to suggestions of focus groups, but also theoretically grounded in the literature. 			

Based on previous theoretical findings and focus group discussions, it was decided to adopt the **Likert-type rating scale** in the instrument to measure the attitudes of teachers towards the CRISS platform. Relevant IS literature supports the application of this scale characterizing it as practical and straightforward (Bhattacharjee, 2001; Viswanathan et al., 2004).

Items were measured using a **scale of attitudes** that contain five degrees of:

- **Agreement or disagreement** (1 – Strongly disagree, 3 – Neither agree nor disagree, 5 – Strongly agree) for five constructs: Perceived effectiveness, Perceived efficiency, IS continuance intention, Satisfaction and Perceived usefulness.
- **The expectation** on system performance (1 – Far below my expectations, 3 – In line with my expectations, 5 – Far beyond my expectations) for the Confirmation construct.

The **demographic items** covered variables such as age, gender, teaching experience, level of computer skill, frequency of system use and similar, mostly measuring them through nominal scales (Cohen et al., 2018).

4.3.3 Instrument Testing

The result of conducted experts' ratings and focus groups is a quantitatively oriented **survey instrument**. The survey was initially designed in English, but it has been translated into the official languages of some countries in which the research was conducted. This was done to give the respondents a better understanding of the survey content and to collect valid responses. The translation was made using a **forward-backwards method** according to which the survey from the **source** language (English) was translated by an authorized person (**translator**) into the **target** language (forward translation), and then translated again into the source language by another authorized person (backward translation) (Wild et al., 2005). In the process, it was necessary to maintain translators' objectivity, who had (Wild et al., 2005):

- (1) To be native speakers of the source language
- (2) High proficiency in the target language
- (3) No knowledge of the original translation of the instrument (valid for backward translator).

Once the backward translations were completed, the surveys were compared with their initial English versions. The thesis candidate, as the creator of the survey, was responsible to compare their conceptual equivalence. A small number of ambiguities in translated surveys were solved with project partners since the translation process took place in five countries – Croatia, Greece, Italy, Romania and Spain, while Sweden decided to use the English version of the survey. Other translations of the survey are available upon request.

Translated surveys were then entered into the online platform LimeSurvey (LimeSurvey GmbH, 2003) which served to distribute it, but also to collect responses during the pre-testing and full-scale testing. This tool was chosen due to its free access provided for the academic researchers of the University of Zagreb through the University Computing Centre. It offers a multilingual interface for implementing various translations of the survey and it is very intuitive to use by both researchers and respondents. The pre-testing and full-scale testing of the survey instrument are explained below.

Pre-testing

An email with a link to the online survey was sent to a small sample of randomly selected teachers since focus groups are not considered an adequate substitute for pre-test (Fuller et al., 1993). It was important to test if the questions fit the overall context of the survey and if they are understandable to target respondents during the full-scale testing (Sekaran & Bougie, 2016).

In total, **eight teachers from six countries** (Croatia, Greece, Spain, Italy, Romania and Sweden) were contacted for the survey pre-testing on April 1, 2019. Teachers had two weeks to report their observations and propose refinements due to:

- (1) Possible ambiguous and/or uncertain expressions in the items
- (2) The feasibility of the survey in terms of the technical correctness of the LimeSurvey online tool.

Teachers' feedback was applied as minor modifications of items and instructions related to completing the survey. LimeSurvey was considered a completely reliable tool for conducting online research.

Full-Scale Testing

Following the pre-testing process, **full-scale testing** began by sending the link to the online survey to 1.102 primary and secondary school teachers directly to their email addresses in two rounds:

- The first round of sending emails: April 29, 2019
- The second round of sending emails: May 20, 2019

Previously, the thesis candidate received teachers' email addresses by contacting the project partners who were responsible for the communication with schools and obtained the permission of 134 headmasters (for details, see [4.2 Sampling Design](#)). To **mitigate the risks of low response rate** to survey, the following steps were undertaken (Sekaran & Bougie, 2016; Wright, 2002):

- (1) Teachers were notified in advance (on April 26, 2019) via email about the forthcoming online survey
- (2) The introduction part of the survey explained the purpose and significance of the research to encourage the respondents to participate

- (3) The characteristic of voluntariness and anonymity was also emphasized for the respondents to provide honest answers
- (4) Respondents were reminded to complete the survey approximately one month after the first round of sending emails
- (5) The survey is kept as brief as possible, but without disrupting the conducted scientific process of instrument development.

The survey was open for completion until June 30, 2019. As a result, 223 surveys were received in the first round of sending emails between April 29, 2019, and May 19, 2019, and 130 surveys were received in the second round between May 20, 2019, and June 30, 2019. In total, **353 survey responses** were received between April 29, 2019, and June 30, 2019.

Given the international dimension of the survey, the electronic design has facilitated its distribution to the respondents that are dispersed geographically (Saunders et al., 2016). The challenging side of an online survey in researches is that it was noticed a low response rate and uncertainty of whether obtained data are unbiased since answers of non-respondents may differ from actual-respondents (Saunders et al., 2016). This is also recognized as one of the limitations of this thesis.

In the LimeSurvey tool, it was set that the respondents cannot skip questions to avoid missing values later during data analysis. For better understanding and giving as accurate responses as possible, each category was explained to the respondents based on their usual practice of using the *CRISS platform* (e.g. Perceived efficiency - *CRISS platform is designed to enable teachers to perform certain activities in a quick and easy way. Therefore, it is very important to receive your opinion about how fast do you think you are in performing certain activities with the support of the CRISS platform, or whether it is easy for you to find an option to check students' progress or make a new plan, and similar*).

However, this **survey strategy** made it possible to measure the given constructs and provide an answer to the research question. Among other things, it is a research topic that can be measured by such a quantitative method. A review of the literature found that users' attitudes toward different IS were also measured by a quantitative instrument such as the one developed in this thesis. It would also not be possible to meet the set fourth objective RO₄ (“*To determine the cause-and-*

effect relationships between variables of an extended research model using the method of structural equation modelling”) without the application of quantitative research instrument nor to test the proposed hypotheses. The research model is built on the existing well-established model (ECM) and theories identified during the literature review. In other words, since all items are theoretically grounded (have been confirmed before) having undergone several rounds of experts’ assessment, it is expected that the survey instrument will properly collect the data (Pinsonneault & Kraemer, 1993).

In this research context, collecting data of 353 primary and secondary teachers on what will affect their continuance intention to use the CRISS platform will serve as a foundation for a deeper understanding of future users. Especially since the **analysed demographic data** largely coincide with the data found in the relevant official documents of Eurostat and European Commission (European Commission/EACEA/Eurydice, 2013; Eurostat, 2016) which allows better **generalizability** in a sense that the results from the target group can also be applied to a broader group of teachers across Europe. Recognized similarities of teachers are:

- Highly educated
- Mostly female teachers, which is more pronounced in primary education than in secondary
- The teaching workforce is ageing. Over 60% of teachers are older than 40 in primary education, while at the secondary level this percentage is even more significant.

The above also reduced the limitations associated with the use of judgement sample available and agreeable to participate in research at a given time and increased the level of its representativeness.

4.4 Legal and Ethical Considerations

When studying human behaviour, it is extremely important to consider the possibility of ethical issues before, during and after the data collection phase (Zikmund, 2003). The omission of certain ethical issues could affect the lack of compliance and cooperation by participants, which would consequently complicate data collection (Sekaran & Bougie, 2016). In this particular case, it was not necessary to establish strict ethical guidelines and to obtain the consent of the participants (primary and secondary school teachers) for data collection, as they could not be identified by their answers, and they did not have to provide personal data to participate in the survey. Due to the

eligibility of the results, the participants were informed at the beginning of the survey about the aims of the planned research and the structure of the questions (see [Appendix C](#) and [Appendix D](#) for Croatian and English survey translation, respectively). In line with the suggestion of Sekaran and Bougie (2016), they were also explained that:

- Their participation is anonymous and voluntary
- Their responses are interpreted at a group level
- Their responses will contribute to the development of systems for the acquisition and evaluation of digital competences.

Thus, the applied research design aimed to collect data from primary and secondary school teachers who used the CRISS platform developed within the EU project. The whole research was conducted as part of the CRISS project which complied with the General Data Protection Regulation (GDPR) and other EU legislative. All project partners had the obligation of managing the process of ethical issues and protecting the privacy and personal data during the project lifetime and beyond. The project also sought to equally include male and female participants, which is in line with EU decisions related to gender equality.

5 DATA ANALYSIS AND RESULTS

In this chapter univariate and multivariate statistical analyses were applied to the collected primary empirical data. Data were screened for missing values, data errors and inconsistencies, but no anomalies were identified during the process. All received surveys were eligible for further analysis.

The sociodemographic characteristics of the sample were analysed and discussed in terms of frequency and percentage. The information related to the survey instrument were summarized using **descriptive statistics** where its common measures of central tendency, variability and shape were interpreted (Field, 2009). Both characteristics of respondents and descriptive statistics of the measurement instrument were processed utilizing Microsoft Excel and R (R Core Team, 2017).

On the other hand, **multivariate analysis** was performed using the partial least squares structural equation modelling (PLS-SEM) and covariance-based structural equation modelling (CB-SEM). Both methods belong to second-generation techniques that “*simultaneously analyse multiple variables*” (Hair et al., 2017, p. 2) and they are increasingly used by researchers in social sciences.

The PLS-SEM was used for the most analysis conducted in this thesis because it is suitable to test a theoretical framework from a prediction perspective, to establish a complex structural model with many constructs, indicators and relationships and to conduct exploratory research for theory development (Hair et al., 2019). The analysis of measurement and structural model were conducted in SmartPLS (v. 3.3.3) (Ringle et al., 2015). Although an **optimal subject (N=353) to item ratio was achieved** of >10:1 during data collection, PLS-SEM works efficiently even with smaller sample sizes and complex models (Hair et al., 2017). Furthermore, PLS-SEM is a non-parametric method (there are no distributional data assumptions) that does not lose statistical power. However, this method is still not fully adequate to estimate the goodness-of-model fit and therefore the confirmatory factor analysis (CFA) stage of covariance-based structural equation modelling (CB-SEM) was applied in IBM SPSS Amos 21.0. (Arbuckle, 2012).

A **two-step approach was used to assess the proposed research model** (Hair et al., 2019):

1. The **reflective measurement model** was validated in terms of statistical reliability, convergent validity and discriminant validity (see [5.3 Measurement Model Assessment](#)). Additionally, model fit indices were tested and reported in [sub-chapter 5.4](#).
2. The **structural model** was examined by checking the collinearity between the variables (VIF), the coefficients of determination (R^2), the magnitude of the impact (f^2), the predictive relevance (Q^2) by using the blindfolding technique and the significance of the path coefficient (see [5.5 Structural Model Assessment](#)).

Measurable results regarding the main aim and research question of the thesis are based on the analysis performed in the previously mentioned [sub-chapter 5.5](#). While the hypothesized mediating role of satisfaction (hypotheses H1 and H2) and the moderator influence of two variables (hypotheses H3 and H4), the level of computer skill and duration of use (in hours per week), were examined in [sub-chapter 5.5.2 Mediator and Moderator Analysis](#).

5.1 Characteristics of Respondents

A detailed explanation of sampling design was given in [sub-chapter 4.2](#) of this thesis. When collecting data, an attempt was made to achieve ten times more respondents than the number of included items ($n=29$) to achieve the sample representativeness for the implementation of the quantitative part of research (Hair et al., 2017). Although, no consensus is reached in studies regarding the optimal sample size (Baruch & Holtom, 2008).

In total 1.102 emails with the link to the online survey were distributed to primary and secondary teachers in six European countries (Croatia, Greece, Italy, Romania, Spain and Sweden) who participated in EU project CRISS from 2017 to 2019 and registered in the CRISS platform piloted within the project. Data were collected in a period between April 29, 2019, and June 30, 2019. This was done at the end of the school year (before the summer break) when teachers already had some time of interaction with the CRISS platform and could provide accurate feedback regarding their experiences and attitudes. It was received **353 complete responses that could be further analysed**. There were no ineligible respondents.

Nevertheless, it is not expected a 100% response rate in a standard research process with an online survey (Baruch & Holtom, 2008). Furthermore, Denscombe (2014) stated there are no standardized estimates to determine what is and what is not an adequate response rate and that everything depends on the context. In this research, a common way for calculating the **total response rate**, provided by Saunders et al. (2016) is used:

$$\text{total response rate} = \frac{\text{total number of responses}}{\text{total number in sample} - \text{ineligible}} = \frac{353}{1102 - 0} = 32.03\%$$

A calculated total response rate is not high, probably for the reason that Saunders et al. (2016, p. 284) explain as survey “fatigue” in respondents. Nevertheless, it is in line with the research of Nulty (2008) who compared several studies and showed that the average response rate in online surveys ranges between 20% and 47%.

The sociodemographic characteristics of respondents are recorded in Table 10.

Table 10. Sociodemographic characteristics of respondents (N=353)

<i>Sociodemographic characteristics of respondents</i>		Frequency	Percentage (%)
Gender	Male	113	32.01
	Female	240	67.99
Age	Under 25	1	0.28
	25-29	21	5.95
	30-39	100	28.33
	40-49	137	38.81
	50-59	88	24.93
	Over 60	6	1.70
Country	Croatia	52	14.73
	Spain	138	39.09
	Greece	70	19.83
	Italy	57	16.15
	Romania	19	5.38
	Sweden	17	4.82
Education	High school diploma	3	0.85
	Associate's degree	0	0.00
	Bachelor's Degree	158	44.76
	Master's Degree	169	47.88
	Doctorate Degree	23	6.52
Workplace	Primary school	81	22.95
	Secondary school	272	77.05
Teaching experience	Less than 1 year	3	0.85
	1-2 years	15	4.25

	3-5 years	50	14.16
	6-10 years	46	13.03
	11-15 years	87	24.65
	16-20 years	61	17.28
	Over 20 years	91	25.78
Computer skill	Fundamental Skills (Typing, Mouse)	7	1.98
	Basic Computing and Applications	57	16.15
	Intermediate Computing and Applications	159	45.04
	Advanced Computing and Applications	72	20.40
	Proficient Computing, Applications, and Programming	58	16.43

It can be noted that the gender distribution is uneven, in favour of female respondents. Furthermore, most of the respondents are older than 40 years (65.44%). The response rate is also unequal between countries and therefore unsuitable to be analysed on a cultural level. The results show that more than half of the respondents have higher education. The higher response rate to the survey was from secondary school teachers. Results also show that more than half of them have over 11 years of teaching experience. With regards to computer skills, they were all listed and described to respondents within the survey. Most teachers reported having an intermediate or high level of computer skills (81.87%), meaning they were advanced computer users. The behavioural characteristics of respondents are shown in Table 11.

Table 11. Behavioural characteristics of respondents (N=353)

<i>Behavioural characteristics of respondents</i>		Frequency	Percentage (%)
Duration of the CRISS platform use (in months)	Less than 1 month	66	18.70
	1-2 months	78	22.10
	2-3 months	71	20.11
	More than 3 months	138	39.09
Weekly access (to the CRISS platform)	Never	47	13.31
	1 - 3 times a week	236	66.86
	4 - 6 times a week	52	14.73
	7 - 9 times a week	12	3.40
	10 - 12 times a week	4	1.13
	More than 12 times a week	2	0.57
Duration of the CRISS platform use (in hours per week)	Less than 1 hour a week	117	33.14
	1 - 2 hours a week	137	38.81
	3 - 4 hours a week	79	22.38
	More than 4 hours a week	20	5.67

Respondents had a rather diverse duration of the CRISS platform use. Although, the majority have used it for more than two months. More than half of the respondents stated that they have accessed the CRISS platform once to three times a week, while the minority reported a higher access frequency. Some respondents reported they have never had weekly access, meaning they had occasional interactions with the platform, probably monthly. More than half of the respondents reported they have spent less than two hours weekly using the platform.

Open-ended questions revealed that, on average, teachers administered and guided 26.65 ($SD=23.87$) students in the CRISS platform. Data show what was known during the project that in most cases the teachers chose one to two classes with which they have used the system. In general, these were the teachers who taught an average of 102.59 students ($SD = 82.35$) in primary or secondary schools. The data show that the research involved teachers of different educational backgrounds and interests.

5.2 Descriptive Statistics

Descriptive statistics for each construct of the research model is provided in Table 12. The mean (M) values of the constructs range from 2.44 to a maximum of 3.38. Confirmation (CON) of expectations has the lowest stated mean value, while Perceived effectiveness (PFE) has the highest. On the other hand, both Perceived efficiency (PFI) and Perceived usefulness (PU) have the highest standard deviation (SD) of 0.99. The lowest SD is calculated for Perceived effectiveness.

Table 12. Descriptive statistics for each construct

Construct	Number of items	M	SD
PFE	6	3.38	0.88
PFI	7	3.28	0.99
CI	3	3.21	0.94
SAT	4	3.27	0.93
PU	4	3.08	0.99
CON	5	2.44	0.92

Note: Perceived effectiveness (PFE); Perceived efficiency (PFI); IS continuance intention (CI); Satisfaction (SAT); Perceived usefulness (PU); Confirmation (CON); Mean (M); Standard deviation (SD)

In Table 13 descriptive statistics of each item included a measure of central tendency (mean), a measure of variability (standard deviation) and measures of shape (kurtosis and skewness) (Field, 2009). The highest mean value of 4.01 was recorded for item PFI1, while the lowest was for CON3 which was 2.35. The standard deviation ranged from 0.82 (PFE2) to 1.01 (PU4). The farther the measures of shape are from zero, the greater the chance that the data is not normally distributed. However, values for skewness and kurtosis between -2 and 2 indicate a reasonably normal distribution (Bachman, 2004). Assessed items' values of kurtosis and skewness were within the predicted range. Same measures were also calculated for two moderator variables – *level of computer skill* (M=3.33, SD=1.00, Kurtosis=-0,54, Skewness = 0.18) and *duration of use* (M=2.01, SD=0.88, Kurtosis=-0.61, Skewness = 0.48) which will be later examined within the proposed structural model.

Table 13. Descriptive statistics for each item (N=353)

Items	M	SD	Kurtosis	Skewness
PFE1	3.42	0.84	0.18	-0.22
PFE2	3.40	0.82	-0.01	0.12
PFE3	3.23	0.91	-0.66	-0.02
PFE4	3.30	0.88	0.19	-0.20
PFE5	3.47	0.89	0.11	-0.35
PFE6	3.43	0.92	-0.11	-0.40
PFI1	2.98	0.95	-0.56	0.64
PFI2	2.98	0.90	-0.25	0.35
PFI3	3.28	0.95	0.06	-0.45
PFI4	3.25	0.91	-0.66	0.14
PFI5	3.37	0.91	0.08	-0.25
PFI6	3.12	0.99	-0.53	0.06
PFI7	4.01	0.90	1.09	-0.96
CI1	3.29	0.96	-0.44	0.02
CI2	3.06	0.89	-0.27	0.33
CI3	3.28	0.97	-0.48	-0.06
SAT1	3.33	0.97	-0.24	-0.25
SAT2	3.23	0.99	0.04	-0.25
SAT3	3.23	0.90	0.11	0.07
SAT4	3.30	0.85	0.12	-0.04
PU1	2.84	0.96	-0.19	0.10
PU2	2.92	0.98	-0.25	0.06
PU3	3.41	0.91	-0.22	-0.27
PU4	3.14	1.01	-0.49	0.15
CON1	2.41	0.95	-0.39	0.14
CON2	2.53	0.88	0.10	0.26
CON3	2.35	0.88	0.21	0.44
CON4	2.37	0.90	-0.35	0.12
CON5	2.53	0.95	-0.32	0.00

Note: Mean (M); Standard deviation (SD)

5.3 Measurement Model Assessment

There were no missing values in the dataset because the LimeSurvey platform was set to remind the respondent of unfinished questions. A total of 29 measurement items were modelled as reflective indicators to their corresponding constructs. The most important metrics used for the measurement model assessment were (Hair et al., 2017): **reliability, convergent validity and discriminant validity**. Furthermore, convergent and discriminant validity are the corresponding elements of a larger measurement concept, **construct validity** (Straub & Gefen, 2004). Although, Gefen and Straub (2005) argue that former validities include certain aspects of goodness-of-fit of the measurement model, analysis and discussion of fit indices to support the conclusions on construct validity has been conducted. **Overall, the third research objective RO₃ is fully achieved by establishing a valid measurement model.**

The data-model fit assessment was conducted as a CFA stage of CB-SEM with IBM SPSS Amos 21.0. (Arbuckle, 2012) in the next sub-chapter 5.4. But, before doing the CFA, it was necessary to establish convergent and discriminant validity, as well as reliability (Hair et al., 2010). This was achieved with PLS Algorithm in SmartPLS (v. 3.3.3) (Ringle et al., 2015):

1. Weighting Scheme: Path Weighting Scheme
2. Maximum Iterations: 300
3. Stop Criterion (10^{-X}): 7
4. Initial Weights: 1.0 (*Advanced Settings*)

5.3.1 Reliability and Convergent Validity

The reliability of the proposed instrument is tested to show how consistently it measures a posited concept (Sekaran & Bougie, 2016). The most commonly used measure of reliability is **internal consistency reliability**, which was measured utilizing **Cronbach's Alpha (CA)** and **Composite Reliability (CR)** (Hair et al., 2017).

Analyses showed satisfactory results where both **CA and CR** were greater than 0.70 (Hair et al., 2017; Straub & Gefen, 2004). Usually, their values range from 0 to 1, with values closer to 1 indicating greater reliability (Al-Emran et al., 2019). However, in some cases as such where CR was higher than 0.95, this could indicate redundancy of indicators within the latent variable (Hair et al., 2019). Therefore, indicators of the Satisfaction (SAT) variable were once again compared, and it was decided to omit the SAT2 item ("I like using the CRISS platform") from further analysis. There are several reasons for this – conceptually, it was very similar to the SAT3 item ("I am satisfied with my use of the CRISS platform"), and multiple performed tests of reliability have found the largest reduction in CR.

The **convergent validity** is measured to identify whether indicators correlate positively with other indicators of the same reflective construct (Hair et al., 2017). The criteria for assessing convergent validity are **(outer) loadings of the indicators** and **average variance extracted (AVE)** (Al-Emran et al., 2019). All indicators had loadings over the acceptable threshold of 0.60 (Gefen & Straub, 2005) except for the PFI7 indicator which had a loading of 0.55. Thus, it was removed from the construct. Higher loadings suggest that the indicators have much in common which is encompassed by the construct (Al-Emran et al., 2019). The AVE values of all reflectively measured constructs are greater than 0.50 which indicates "good" convergent validity and that the "construct explains more than half of the variance of its indicators" (Hair et al., 2017, p. 114). Table 14 presents the final results of convergent validity and internal consistency reliability.

Table 14. Measurement model

Latent variables and indicators	Convergent Validity		Internal Consistency Reliability	
	Loading	AVE	CA	CR
Perceived effectiveness (PFE)		0.72	0.92	0.94
PFE1	0.86			
PFE2	0.87			
PFE3	0.83			
PFE4	0.84			
PFE5	0.87			
PFE6	0.80			
Perceived efficiency (PFI)		0.62	0.88	0.91
PFI1	0.70			
PFI2	0.82			
PFI3	0.81			
PFI4	0.81			
PFI5	0.83			
PFI6	0.76			
PFI7	0.55*			
IS continuance intention (CI)		0.82	0.89	0.93
CI1	0.92			
CI2	0.92			
CI3	0.89			
Satisfaction (SAT)		0.85	0.91	0.94
SAT1	0.91			
SAT2	0.92*			
SAT3	0.91			
SAT4	0.92			
Perceived usefulness (PU)		0.76	0.90	0.93
PU1	0.84			
PU2	0.88			
PU3	0.89			
PU4	0.88			
Confirmation (CON)		0.72	0.90	0.93
CON1	0.89			
CON2	0.82			
CON3	0.81			
CON4	0.88			
CON5	0.85			

Note: Cronbach's alpha (CA)>0.7; Composite Reliability (CR)>0.7; Loading \geq 0.70; Average Variance Extracted (AVE) \geq 0.50.

*Indicators PFI7 (lower loading) and SAT2 (reduces construct validity) were omitted from subsequent analysis.

5.3.2 Discriminant Validity

The discriminant validity seeks to examine whether there is an empirical difference between the constructs in the model (Hair et al., 2017). A certain phenomenon should be explained by only one unique construct and no other (Al-Emran et al., 2019). This thesis applied three approaches for the evaluation of **discriminant validity: cross-loadings, Fornell-Larcker criterion and Heterotrait-Monotrait Ratio (HTMT)** of the correlations. Researchers traditionally used cross-loadings and the Fornell-Larcker criterion, but these two measures have been criticized for not being reliable in detecting issues of discriminant validity (Hair et al., 2017). Hence, a third measure has been introduced here, the HTMT.

When measuring cross-loadings, the discriminant validity is achieved when the loading of the indicator is highest on the assigned construct and lower on other constructs. When examining cross-loadings, Hair et al. (2017). suggested that the cut-off value of the indicator's loading should be at least 0.70 and above. Furthermore, Table 15 shows the cross-loadings of indicators across constructs indicating the satisfactory level of discriminant validity.

Table 15. Cross-loadings

	PFE	PFI	CI	SAT	PU	CON
PFE1	0.86	0.62	0.56	0.65	0.68	0.58
PFE2	0.87	0.68	0.53	0.63	0.62	0.58
PFE3	0.83	0.59	0.61	0.67	0.68	0.57
PFE4	0.84	0.61	0.55	0.62	0.63	0.56
PFE5	0.87	0.65	0.52	0.60	0.62	0.52
PFE6	0.80	0.65	0.47	0.56	0.58	0.53
PFI1	0.51	0.70	0.40	0.40	0.47	0.52
PFI2	0.60	0.82	0.57	0.60	0.62	0.59
PFI3	0.60	0.81	0.55	0.56	0.56	0.54
PFI4	0.63	0.81	0.53	0.58	0.53	0.54
PFI5	0.64	0.83	0.53	0.60	0.57	0.55
PFI6	0.55	0.76	0.42	0.50	0.49	0.47
CI1	0.60	0.58	0.92	0.66	0.68	0.58
CI2	0.59	0.61	0.92	0.64	0.63	0.56
CI3	0.56	0.56	0.89	0.69	0.61	0.50
SAT1	0.69	0.65	0.75	0.91	0.75	0.66
SAT3	0.64	0.61	0.61	0.92	0.66	0.60
SAT4	0.70	0.65	0.65	0.94	0.71	0.64
PU1	0.65	0.63	0.62	0.65	0.84	0.65
PU2	0.62	0.58	0.61	0.67	0.88	0.61
PU3	0.67	0.55	0.63	0.68	0.89	0.61
PU4	0.68	0.65	0.62	0.68	0.88	0.68
CON1	0.60	0.62	0.58	0.65	0.68	0.89
CON2	0.52	0.56	0.47	0.51	0.58	0.82
CON3	0.50	0.54	0.41	0.48	0.56	0.81
CON4	0.56	0.56	0.53	0.62	0.63	0.88
CON5	0.60	0.61	0.54	0.64	0.64	0.85

Note: Perceived effectiveness (PFE); Perceived efficiency (PFI); IS continuance intention (CI); Satisfaction (SAT); Perceived usefulness (PU); Confirmation (CON).

The **Fornell-Larcker Criterion** also provided evidence for an optimal level of discriminant validity of each construct. From the data in Table 16, it can be noticed that bolded values (square root of construct's AVE) on diagonal are higher than other values (squared inter-construct correlation) below them (Hair et al., 2019).

Table 16. Fornell-Larcker Criterion

	CON	CI	PFE	PFI	PU	SAT
CON	0.85					
CI	0.60	0.91				
PFE	0.66	0.64	0.85			
PFI	0.68	0.64	0.75	0.79		
PU	0.73	0.71	0.75	0.69	0.87	
SAT	0.69	0.73	0.74	0.69	0.77	0.92

Note: Perceived effectiveness (PFE); Perceived efficiency (PFI); IS continuance intention (CI); Satisfaction (SAT); Perceived usefulness (PU); Confirmation (CON).

The **HTMT** the newest measure of discriminant validity represented as “*the mean value of the item correlations across constructs relative to the (geometric) mean of the average correlations for the items measuring the same construct*” (Hair et al., 2019, p. 9). It was proposed in 2015 (Henseler et al., 2015) as a replacement for cross-loading and the Fornell-Larcker criterion that is still actively used by researchers as additional information of discriminant validity. The HTMT values higher than 0.90 (Hair et al., 2017) may indicate problems with discriminant validity which is not the case here in Table 17. No issues of collinearity between latent constructs were detected.

Table 17. Heterotrait-monotrait (HTMT) ratio of correlations

	CON	CI	PFE	PFI	PU	SAT
CON						
CI	0.67					
PFE	0.72	0.70				
PFI	0.76	0.72	0.83			
PU	0.81	0.79	0.83	0.77		
SAT	0.75	0.80	0.80	0.76	0.85	

Note: Perceived effectiveness (PFE); Perceived efficiency (PFI); IS continuance intention (CI); Satisfaction (SAT); Perceived usefulness (PU); Confirmation (CON). HTMT < 0.90

5.4 Data-Model Fit Assessment

Researchers are suggested not to report fit measures and criteria for the assessment of results in PLS-SEM, since being in the early stages of research and do not provide sufficient information on model fit (Hair et al., 2019). Therefore, a model was subjected to **Confirmatory Factor Analysis (CFA)** which is one of Structural Equation Modelling (SEM) techniques that “*allows for the assessment of the fit between observed data and an a priori conceptualized, theoretically grounded model ...*” (Mueller & Hancock, 2001, p. 5239). This data-model fit assessment will contribute to previously established convergent and discriminant validity in supporting the construct validity (Straub & Gefen, 2004).

According to Brown (2015), the indices used to estimate the **goodness of model fit** can be divided into three categories (see Table 18): absolute fit, fit adjusting for model parsimony, and incremental (comparative) fit. The cut-off values in the table are set for each index that will be used here for the assessment of the model fit. Researchers are suggested to use at least one index from each of these categories in their work because each type of index provides different information about the model fit (Brown, 2015).

Table 18. Goodness-of-fit indices (Brown, 2015; Perry et al., 2015; Segars & Grover, 1998)

Category of fit indices	Goodness-of-fit indices	Cut-off values
Absolute fit	Chi-square (χ^2)	Statistically not significant at $p > 0.05$.
	Standardized Root Mean Square Residual (SRMR)	SRMR can take a range of values between 0.0 (perfect fit) and 1.0. SRMR < 0.08
	Root Mean Square Residual (RMR)	Sometimes difficult to interpret because the metric of the input variables can affect its value.
	Goodness-of-Fit Index (GFI)	GFI > 0.90-0.95
	Adjusted Goodness-of-Fit Index (AGFI)	AGFI > 0.90-0.95
Fit adjusting for model parsimony	Root Mean Square Error of Approximation (RMSEA)	RMSEA < 0.06
Incremental (comparative) fit	Comparative Fit Index (CFI)	CFI can take a range of values between 0.0 and 1.0 (good model fit). CFI > 0.90-0.95
	Tucker–Lewis Index (TLI)	TLI can be outside the range of 0.0 and 1.0. However, values closer to 1 imply a good model fit. TLI > 0.90- 0.95

The CFA was conducted for the model using IBM SPSS Amos 21.0. (Arbuckle, 2012). The previous estimation of convergent and discriminant validity of the measurement model showed respective results in terms of moderate and high factor loadings (>0.6) on their prospective construct and low loadings on other constructs. Two indicators (PFI7 and SAT2) were omitted during the validity examination due to their tendency of model distortion, and therefore the CFA was conducted without them. However, other indicators were once again analysed whether they load on the same construct with CFA as they did during the evaluation of convergent validity. The results showed that all indicators loaded correctly on their intended construct in a range of 0.60 and higher (Gefen & Straub, 2005).

The process of measuring model fit started with the examination of **each construct in isolation**, except for Continuance intention (CI) and Satisfaction (SAT) that are not suitable because they have only three indicators (Segars & Grover, 1998). Those constructs were later examined within the overall CFA model. To generate the acceptable fit of each measurement scale (construct), the refinement process was performed iteratively whereby each modification was performed separately one after the other in order not to disrupt the existing structure of the model (Perry et al., 2015). However, the modification was made only when there were sound theoretical reasons to correlate the error terms of indicators. Suggested modifications for each construct are presented in Tables 19-23.

Each measurement scale was examined against the indices defined in Table 18 (except for the RMR index which is considered difficult to interpret and highly sensitive on the metric of input variable and is therefore not recommended for use) (Brown, 2015). However, the focus was on the fit indices such as RMSEA, SRMR, CFI and TLI because of their general satisfactory performance in simulations of Hu and Bentler (Brown, 2015; Hu & Bentler, 1999). Nevertheless, fit indices can vary due to sample size, model complexity, normality of data, type of data, etc. (Brown, 2015). Measured fit indices and a summary of the modifications for each construct are presented in Tables 19-22, and graphically in Figures 8-11. The results from the overall CFA model are shown in Table 23 and Figure 12.

Table 19. Fit indices and modifications for Perceived effectiveness (PFE)

Fit indices	PFE	Modifications
$\chi^2(df)$	7.389(5)	1. PFE5 <--> PFE6 (<i>Information on the platform is complete if I can find an option on the CRISS platform without much trouble.</i>)
p	0.193	
SRMR	0.009	
GFI	0.993	
AGFI	0.971	2. PFE4 <--> PFE5 (<i>CRISS platform allows me to do a certain activity in the way I want it if the information provided on the platform is complete.</i>)
RMSEA	0.037	
CFI	0.998	3. PFE4 <--> PFE6 (<i>CRISS platform allows me to do a certain activity in the way I want it if I can find an option on the platform without much trouble.</i>)
TLI	0.995	

Note: Chi-square (χ^2); Degrees of freedom (df) = the smaller, the better; $p > 0.05$ (not sig.); Standardized Root Mean-square Residual (SRMR) < 0.08 ; Root Mean Square Error of Approximation (RMSEA) < 0.06 ; Goodness of Fit Index (GFI) > 0.90 ; Adjusted Goodness of Fit Index (AGFI) > 0.90 ; Comparative Fit Index (CFI) > 0.90 ; Tucker-Lewis Index (TLI) > 0.90 . Bolded fit indices are the focus of the thesis.

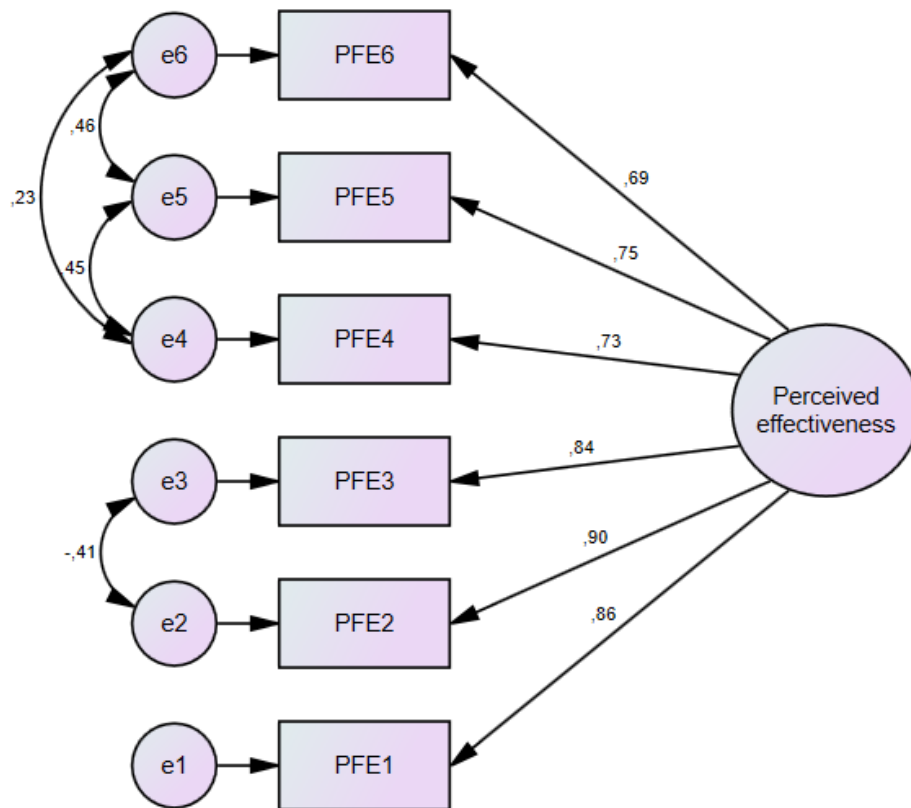

Figure 8. Modifications in Perceived effectiveness

Table 20. Fit indices and modifications for Perceived efficiency (PFI)

Fit indices	PFE	Modifications
$\chi^2(df)$	12.092(7)	1. PFI2 <--> PFI1 (<i>CRISS platform allows me to quickly perform a certain activity if it is fast.</i>) 2. PFI6 <--> PFI5 (<i>It is easy to navigate through the CRISS platform if I can quickly find the information, I need in the CRISS platform.</i>)
p	0.098	
SRMR	0.017	
GFI	0.989	
AGFI	0.966	
RMSEA	0.045	
CFI	0.995	
TLI	0.989	

Note: Chi-square (χ^2); Degrees of freedom (df) = the smaller, the better; $p > 0.05$ (not sig.); Standardized Root Mean-square Residual (SRMR) < 0.08 ; Root Mean Square Error of Approximation (RMSEA) < 0.06 ; Goodness of Fit Index (GFI) > 0.90 ; Adjusted Goodness of Fit Index (AGFI) > 0.90 ; Comparative Fit Index (CFI) > 0.90 ; Tucker-Lewis Index (TLI) > 0.90 . Bolded fit indices are the focus of the thesis.

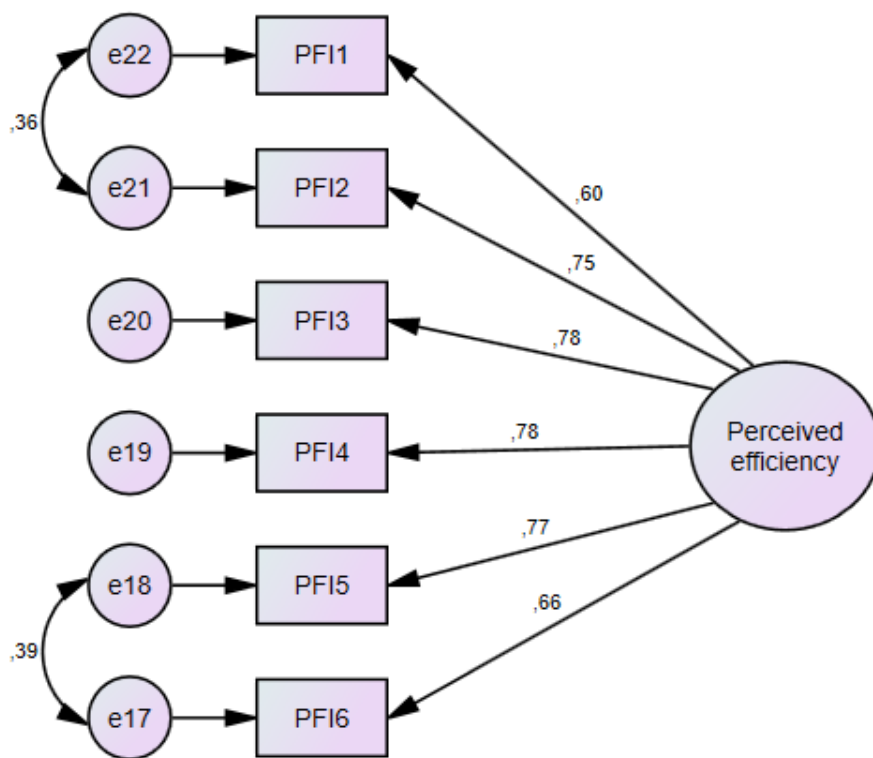

Figure 9. Modifications in Perceived efficiency

Table 21. Fit indices and modifications for Perceived usefulness (PU)

Fit indices	PFE	Modifications
$\chi^2(df)$	1.254(1)	1. PU3 <--> PU1 (<i>CRISS platform is useful for teaching if it helps me to teach faster.</i>)
p	0.263	
SRMR	0.007	
GFI	0.998	
AGFI	0.982	
RMSEA	0.027	
CFI	1.000	
TLI	0.998	

Note: Chi-square (χ^2); Degrees of freedom (df) = the smaller, the better; $p > 0.05$ (not sig.); Standardized Root Mean-square Residual (SRMR) < 0.08; Root Mean Square Error of Approximation (RMSEA) < 0.06; Goodness of Fit Index (GFI) > 0.90; Adjusted Goodness of Fit Index (AGFI) > 0.90; Comparative Fit Index (CFI) > 0.90; Tucker-Lewis Index (TLI) > 0.90. Bolded fit indices are the focus of the thesis.

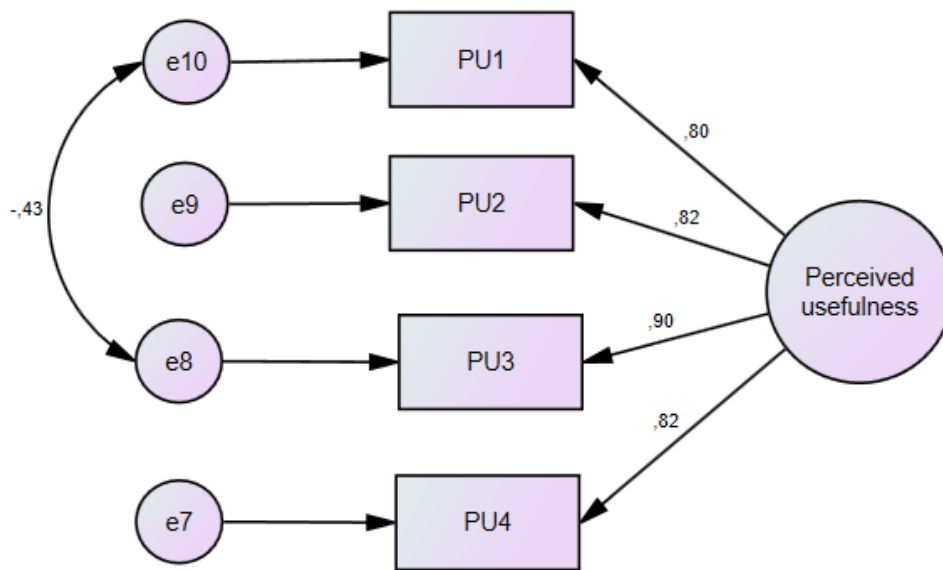

Figure 10. Modifications in Perceived usefulness

Table 22. Fit indices and modifications for Confirmation (CON)

Fit indices	CON	Modifications
$\chi^2(df)$	3.734(3)	1. CON3 <--> CON2 (<i>CRISS platform is useful for teaching if it helps me to teach faster.</i>) 2. CON2 <--> CON1 (<i>The layout of the CRISS platform has met my expectations if the CRISS platform has met all my expectations.</i>)
p	0.292	
SRMR	0.009	
GFI	0.996	
AGFI	0.980	
RMSEA	0.026	
CFI	0.999	
TLI	0.998	

Note: Chi-square (χ^2); Degrees of freedom (df) = the smaller, the better; $p > 0.05$ (not sig.); Standardized Root Mean-square Residual (SRMR) < 0.08 ; Root Mean Square Error of Approximation (RMSEA) < 0.06 ; Goodness of Fit Index (GFI) > 0.90 ; Adjusted Goodness of Fit Index (AGFI) > 0.90 ; Comparative Fit Index (CFI) > 0.90 ; Tucker-Lewis Index (TLI) > 0.90 . Bolded fit indices are the focus of the thesis.

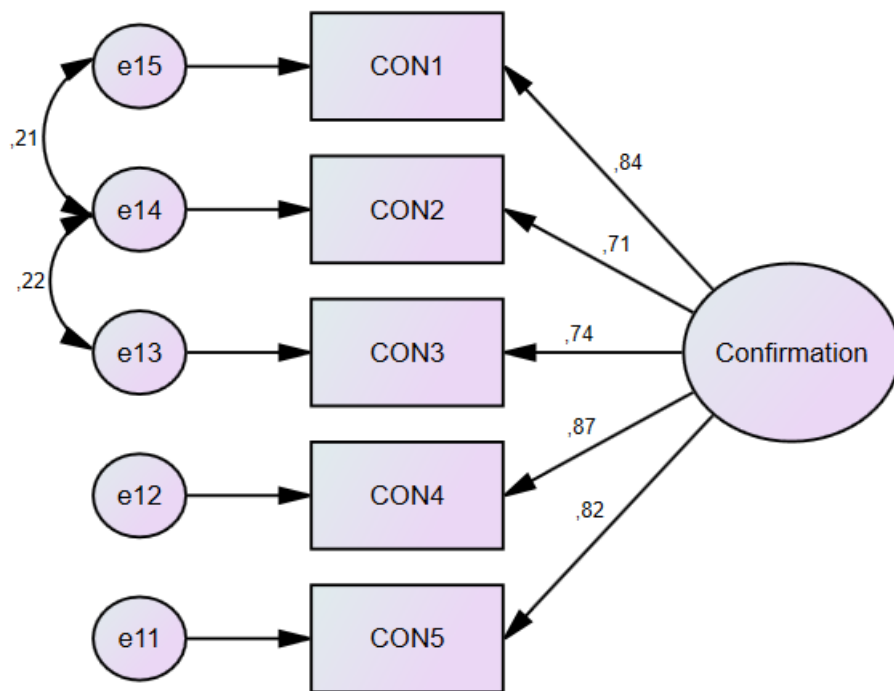

Figure 11. Modifications in Confirmation

Table 23. Fit indices and modifications for overall CFA model

Fit indices	Overall CFA model	Modifications
$\chi^2(df)$	588.684(299)	1. SAT4 <--> SAT3 (<i>I am pleased with how the CRISS platform facilitates my teaching if I am satisfied with my use of the CRISS platform.</i>)
p	0.000	
SRMR	0.038	
GFI	0.885	
AGFI	0.854	
RMSEA	0.052	
CFI	0.962	
TLI	0.956	

Note: Chi-square (χ^2); Degrees of freedom (df) = the smaller, the better; $p > 0.05$ (not sig.); Standardized Root Mean-square Residual (SRMR) < 0.08; Root Mean Square Error of Approximation (RMSEA) < 0.06; Goodness of Fit Index (GFI) > 0.90; Adjusted Goodness of Fit Index (AGFI) > 0.90; Comparative Fit Index (CFI) > 0.90; Tucker-Lewis Index (TLI) > 0.90. Bolded fit indices are the focus of the thesis.

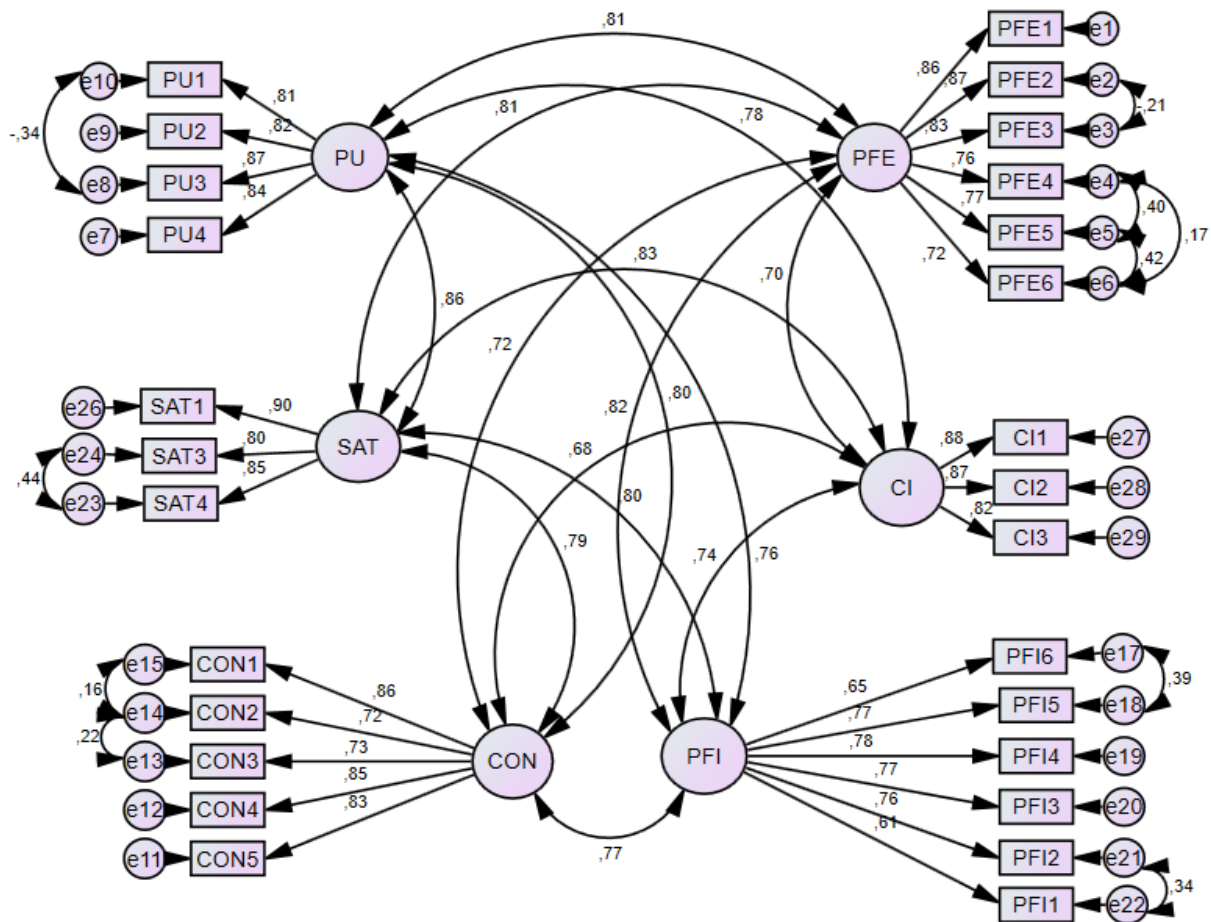

Figure 12. Modifications in the overall CFA model

Four measurement scales were eligible to be assessed in isolation and their chi-square results were statistically not significant ($p > 0.05$) which confirmed their **good fit** (Bentler & Bonett, 1980). All of these measures achieved the cut-off values for absolute fit indices (SRMR < 0.08 , GFI and AGFI of > 0.90), parsimonious fit (RMSEA < 0.06) and incremental fit (CFI and TLI of > 0.90) as recommended (Brown, 2015; Perry et al., 2015; Segars & Grover, 1998).

The overall model was significantly improved by applying some of the suggested modification indices to each scale. However, it did not reach the set thresholds in terms of chi-square, GFI and AGFI. On the other hand, those measures are the subject of a great debate among researchers characterizing them as sensitive to sample size, model complexity and performing poorly in evaluations of model fit (Brown, 2015; Hu & Bentler, 1999). On the other hand, satisfactory results are seen for suggested indices – SRMS, RMSEA, CFI and TLI (Brown, 2015; Hu & Bentler, 1999) implying that the **overall measurement model fits observed data well**. With these results and previously established convergent and discriminant validity, it can be concluded that construct validity is achieved.

5.5 Structural Model Assessment

Once the assessment results of the measurement model and model fit were obtained, the next step was to test the structural model. **In that way, the fourth research objective RO₄ was addressed.** This assessment was done by examining the predictive capabilities of the model and the relationships among latent variables (constructs). In PLS-SEM (Hair et al., 2017), the main criteria to assess the structural model involved variance inflation factor (VIF), the coefficients of determination (R^2), the effect size (f^2), the predictive relevance (Q^2), q^2 and the significance and relevance of the path coefficients. The assessment procedure of the structural model was carried out in the order in which the former criteria were listed (Hair et al., 2017).

The **VIF values** are used to identify the collinearity issues in the structural model (Hair et al., 2017). The following sets of predictor constructs (i.e. exogenous) were assessed for collinearity: (1) PFE, PFI, PU, and SAT as predictors of CI; (2) CON as the predictor of PU; and (3) CON, PFE, PFI, and PU as predictors of SAT. In Table 24 all inner VIF values are below the threshold of five

implying there is no collinearity issue among predictor constructs in the structural model (Hair et al., 2017).

Table 24. Collinearity statistics (Inner VIF values)

	CON	CI	PFE	PFI	PU	SAT
CON					1.00	2.48
CI						
PFE		3.20				3.01
PFI		2.58				2.69
PU		3.07				3.03
SAT		2.96				

Note: Confirmation (CON); IS continuance intention (CI); Perceived effectiveness (PFE); Perceived efficiency (PFI); Perceived usefulness (PU); Satisfaction (SAT). VIF < 5

The **coefficient of determination** (R^2) is a commonly used measure among scholars for assessing the structural model in terms of its predictive power (Al-Emran et al., 2019). The coefficient can be in a range between 0 and 1, whereby higher values reflect a higher level of prediction accuracy. The R^2 values of 0.67, 0.33 and 0.19 are considered substantial, moderate and weak, respectively (Chin, 1998). Following the rule-of-thumb, the R^2 of the endogenous latent variables CI (0.60) and PU (0.53) is considered moderate, whereas SAT (0.68) is considered substantial (see Table 25). However, the results should always be interpreted considering the context of the study, related studies and model complexity (Hair et al., 2019).

Table 25. The R^2 of endogenous latent variables

	R^2	Results interpretation
CI	0.60	Moderate
PU	0.53	Moderate
SAT	0.68	Substantial

Note: IS continuance intention (CI); Satisfaction (SAT); Perceived usefulness (PU).

The **effect size** (f^2) measure signifies the change in R^2 value when a particular exogenous construct is removed from the model and whether it contributes to explaining the endogenous construct (Al-Emran et al., 2019). The effect size is calculated in Table 26 for all the established structural model relationships. With respect to Hair et al. (2017), values of 0.02, 0.15 and 0.35 reflect small, medium and large effects, respectively. The confirmation (CON) had a large effect size on perceived

usefulness (1.15). Perceived effectiveness (PFE) did not affect CI (0.00), while perceived efficiency (PFI), perceived usefulness (PU) and satisfaction (SAT) had a small effect size on CI (0.03, 0.06 and 0.12, respectively). Perceived usefulness had the greatest, but small effect size on SAT (0.13). Exogenous constructs PFI, CON and PFE also had small effect on SAT (0.02, 0.03 and 0.06, respectively).

Table 26. The f^2 effect sizes

	CON	CI	PFE	PFI	PU	SAT
CON					1.15	0.03
CI						
PFE		0.00				0.06
PFI		0.03				0.02
PU		0.06				0.13
SAT		0.12				

Note: Confirmation (CON); IS continuance intention (CI); Perceived effectiveness (PFE); Perceived efficiency (PFI); Perceived usefulness (PU); Satisfaction (SAT).

Another measure to evaluate the predictive accuracy of the path model is the **Q² value** which is an indicator of the model’s “*out-of-sample prediction and in-sample explanatory power*” (Hair et al., 2019, p. 19). It is based on the blindfolding technique which is “*omits every dth data point in the endogenous construct’s indicators and estimates the parameters with the remaining data points*” (Hair et al., 2017, p. 202). The prediction and systematic elimination depend on the omission distance (D) which has to be determined before running the blindfolding procedure. As a guideline, D should be between 5 and 10, and additionally, the number of observations (N=353) divided by the chosen value of D must not be an integer (Hair et al., 2017). The **blindfolding technique** is performed with the omission distance of seven, and the results are represented in Table 27. The cut-off values of 0, 0.25 and 0.5 explain the small, medium and large predictive accuracy of the path model, respectively (Hair et al., 2019).

Table 27. Predictive relevance Q²

	Q ²	Results interpretation
CI	0.48	Medium
PU	0.40	Medium
SAT	0.56	Large

Note: IS continuance intention (CI); Perceived usefulness (PU); Satisfaction (SAT).

The Q² values of all three endogenous latent variables are considerably above zero which supports the model's predictive relevance regarding the endogenous constructs (Hair et al., 2017). More precisely, the SAT has the highest Q² value which indicates a large predictive relevance (0.56) whereas CI (0.48) and PU (0.40) has somewhat lower values and a medium predictive relevance.

The **q² effect size** is a mean to assess the contribution of the exogenous construct to the Q² value of an endogenous latent variable. It is manually computed in Microsoft Excel according to the formula (Hair et al., 2017):

$$q^2 = \frac{Q_{included}^2 - Q_{excluded}^2}{1 - Q_{included}^2}$$

The q² values of 0.02, 0.15 and 0.35, respectively, represent the small, medium and large predictive relevance that exogenous construct has for endogenous construct. In Table 28 confirmation has the largest predictive relevance for perceived usefulness (0.675). The effect sizes of relationships between CON and SAT (0.018), PFE and CI (-0.002), PFI and CI (0.014), and PFI and SAT (0.014) are negligible, while all others are considered of small predictive relevance.

Table 28. The q² effect sizes

	CON	CI	PFE	PFI	PU	SAT
CON					0.675	0.018
CI						
PFE		-0.002				0.039
PFI		0.014				0.014
PU		0.037				0.080
SAT		0.074				

Note: Confirmation (CON); IS continuance intention (CI); Perceived effectiveness (PFE); Perceived efficiency (PFI); Perceived usefulness (PU); Satisfaction (SAT). Numbers are rounded to three decimals in order not to lose the information of the effect size.

5.5.1 Path Analysis

The PLS-SEM algorithm (settings employed as described in the previous chapter) was applied to obtain the estimates for the relationships of the structural model. The path coefficients are standardized values in a range of -1 and 1, and values closer to 1 refer to strong positive relationships among constructs (and vice versa is valid for negative values) (Hair et al., 2017). The significance levels of relationships are assessed using p and t values (Al-Emran et al., 2019). With the significance level of 5% and 1%, the p values had to be smaller than 0.05 or 0.01, respectively, to conclude that the observed relationship among constructs was significant (Hair et al., 2017). The significance level of 1% is taken when researchers need to test the relationship between constructs in a stricter way. Critical t -values for a two-tailed test are 1.65, 1.96 and 2.57 for significance levels of 10%, 5% and 1%, respectively (Hair et al., 2017). In this thesis, structural path coefficients greater than 1.96 were described as significant supporting the relationship between constructs. The following settings were applied for the calculation of relationship significance with the bootstrapping procedure in SmartPLS (v. 3.3.3):

1. Subsamples: 5000
2. Amount of Results: Complete Bootstrapping
3. Confidence Interval Method: Bias-Corrected and Accelerated (BCa) Bootstrap
4. Test Type: Two-Tailed
5. Significance Level: 0.05

Table 29 provides a summary of the path coefficients, standard deviations (SD), t -values, p -values and interpretation of obtained results in terms of relationship significance. The path model with computed estimations and p -values is provided in Figure 13.

Table 29. Summary of the structural model

Paths	Standardized coefficients (β) ^a	SD ^b	t-values ^c	p-values ^d	Interpretation
CON → PU	0.73**	0.03	29.28	0.00	Significant
CON → SAT	0.16**	0.05	2.96	0.00	Significant
PFE → CI	0.02	0.07	0.32	0.75	Non-significant
PFE → SAT	0.25**	0.07	3.61	0.00	Significant
PFI → CI	0.17**	0.06	2.96	0.00	Significant
PFI → SAT	0.15*	0.05	2.72	0.01	Significant
PU → CI	0.28**	0.08	3.70	0.00	Significant
PU → SAT	0.36**	0.06	5.95	0.00	Significant
SAT → CI	0.38**	0.06	6.06	0.00	Significant

Note: ^a Bootstrapping(c) with 5,000 samples (two-tailed test); ^b Standard deviation (SD); ^c $t > 1.96$ (sig. level=5%); ^d * $p < 0.05$; ** $p < 0.01$. Confirmation (CON); IS continuance intention (CI); Perceived effectiveness (PFE); Perceived efficiency (PFI); Perceived usefulness (PU); Satisfaction (SAT).

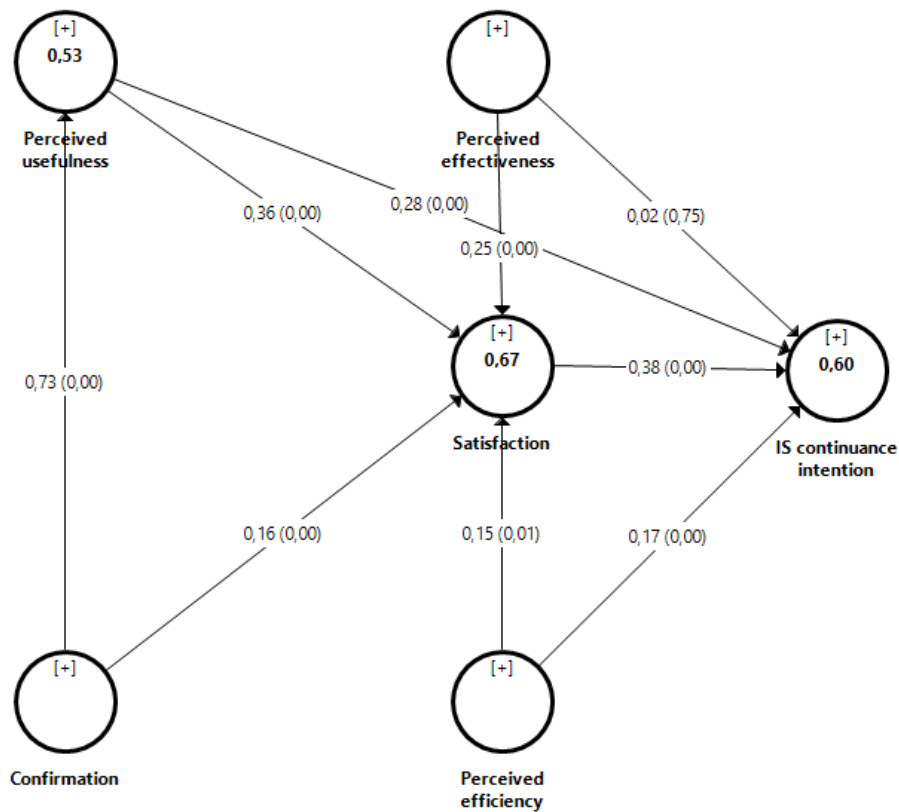

Figure 13. Structural model (Inner model: path coefficients and p-values; Constructs: R Square)

From the analysis, eight positive and significant relationships were identified within the proposed research model. Only one relationship was insignificant ($\beta=0.02$; $p>0.05$) and this is the one between perceived effectiveness (PFE) and continuance intention (CI). It was observed that the confirmation (CON) of expectations had the strongest influence ($\beta=0.73$; $p<0.01$) on perceived usefulness (PU), i.e. expected benefits of using the CRISS platform. Specifically, CON explained 53.4% of the variance in PU.

These results are followed by the satisfactory experience (SAT) towards continuance intention ($\beta=0.38$; $p<0.01$), and perceived usefulness towards satisfaction ($\beta=0.36$; $p<0.01$). Furthermore, it was demonstrated that perceived usefulness had a significant positive impact on continuance intention ($\beta=0.28$; $p<0.01$). The results also indicated significant positive effects on satisfaction for both, perceived effectiveness ($\beta=0.25$; $p<0.01$) and perceived efficiency ($\beta=0.15$; $p<0.05$). However, the strength of the relationship between perceived efficiency and satisfaction was somewhat weaker. On the other hand, perceived efficiency had a positive significant effect on continuance intention ($\beta=0.17$; $p<0.01$) as opposed to perceived effectiveness. Perceived usefulness, confirmation, perceived effectiveness and perceived efficiency explained 67.2% of the variance in satisfaction, while the variance of continuance intention was 59.8% contributed by perceived effectiveness, perceived usefulness, satisfaction and perceived efficiency. The results indicated that eight out of nine proposed structural paths were valid, and one was invalid.

5.5.2 Mediator and Moderator Analysis

After analysing the direct effects between the latent variables, the examination of the indirect ones can be approached. With respect to Henseler et al. (2009) and Nitzl et al. (2016), evaluation of indirect effects in terms of mediation and moderation helps to gain an insight of potential suppressor and spurious impacts of a particular latent variable on another in the model. The hypothesized mediating role of satisfaction and the moderator influence of two variables, the level of computer skill and duration of use (in hours per week), were further examined. **Developed hypotheses are provided below.**

H₁. Satisfaction mediates the relationship between perceived effectiveness and continuance intention to use the system for acquisition and evaluation of digital competences. (*Mediation*)

H₂. Satisfaction mediates the relationship between perceived efficiency and continuance intention to use the system for acquisition and evaluation of digital competences. (*Mediation*)

H₃. Level of computer skill moderates the relationship between satisfaction and continuance intention to use the system for acquisition and evaluation of digital competences. (*Moderation*)

H₄. Duration of use (number of hours per week) moderates the relationship between satisfaction and continuance intention to use the system for acquisition and evaluation of digital competences. (*Moderation*)

The mediator variable facilitates the relationship between the antecedent variable and the dependent variable and can be used to explain why certain relationships are improved or impaired. (Hair et al., 2017; Nitzl et al., 2016). The rationale behind the direct effects of PFE on CI and PFI on CI is that the greater perception of the effectiveness or efficiency of the system will increase the continuous intention to use it. In addition, hypotheses *H1* and *H2* have been made about the influence of the mediator variable (satisfaction) on the relationship between PFE and CI, and PFI and CI (see Figure 14 and Figure 15). Mediation testing requires that all quality criteria of the measurement model (reliability, convergent validity, discriminant validity) and structural model (collinearity level) were met. Once this was achieved, mediation was computed by running the PLS algorithm and bootstrapping procedure. The **analysis of mediation effects** is done as following (Hair et al., 2017):

- (1) To test the specific indirect effects (PLS algorithm)
- (2) To test the significance of the specific indirect effects (Bootstrapping)
- (3) To conclude on the type of mediation (complementary, competitive or indirect-only mediation).

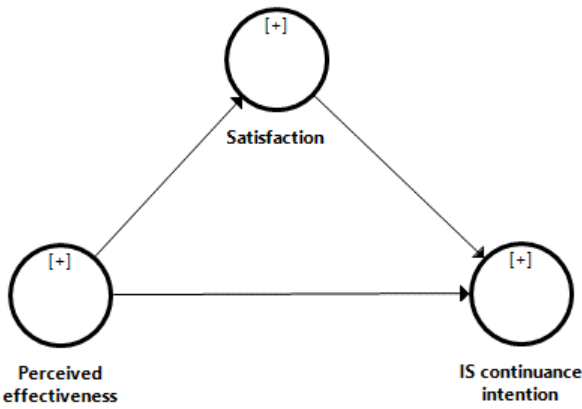

**Figure 14. Isolated mediation model
PFE -> SAT -> CI**

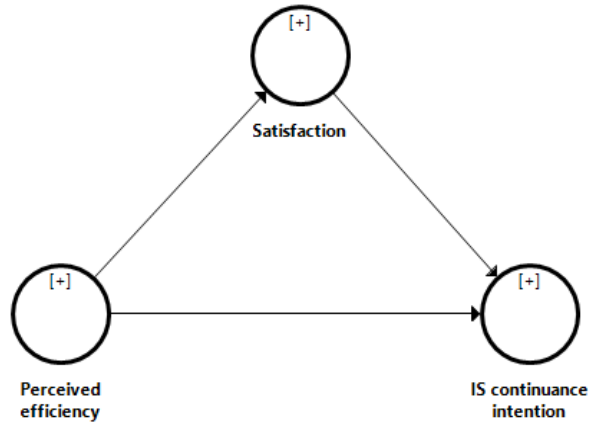

**Figure 15. Isolated mediation model
PFI -> SAT -> CI**

The path model analysis in the previous chapter showed that perceived effectiveness (PFE) has a weak and positive, but statistically non-significant direct effect ($\beta=0.02$; $t=0.32$; $p>0.05$) on continuance intention (CI). However, following the mediation procedure, it can be concluded that satisfaction (SAT) fully mediates ($\beta=0.10$; $t=2.94$; $p<0.01$) this relationship between PFE and CI since “*the indirect effect is significant, but not the direct effect*” (Hair et al., 2017, p. 232). On the contrary, perceived efficiency (PFI) exerts positive and significant direct effect ($\beta=0.17$; $t=2.96$; $p<0.01$) and indirect effect ($\beta=0.06$; $t=2.54$; $p<0.05$) mediated by the satisfaction on the continuance intention. These results indicated a complementary partial mediation where both direct and indirect effects are significant and point in the same direction (Hair et al., 2017). **The findings shown in Table 30 supported both hypotheses H1 and H2:**

H1. Satisfaction mediates the relationship between perceived effectiveness and continuance intention to use the system for acquisition and evaluation of digital competences. **(Supported)**

H2. Satisfaction mediates the relationship between perceived efficiency and continuance intention to use the system for acquisition and evaluation of digital competences. **(Supported)**

Table 30. Summary of the hypotheses (H1. and H2.)

Hypothesized paths	Direct effect	Indirect effect ^a	SD ^b	t-values ^c	p-values ^d	Interpretation
<i>H1.</i> PFE→SAT→CI	PFE→CI (β=0.02; t=0.32; p=0.75) non-sig.	0.10	0.03	2.94	0.00**	Indirect-only (Full mediation); <i>Supported</i>
<i>H2.</i> PFI→SAT→CI	PFI→CI (β=0.17; t=2.96; p=0.00**) sig.	0.06	0.02	2.54	0.01*	Complementary (Partial mediation); <i>Supported</i>

Note: ^a Bootstrapping(c) with 5,000 samples (two-tailed test); ^b Standard deviation (SD); ^c t>1.96 (sig. level=5%);
^d *p<0.05; **p<0.01. Perceived effectiveness (PFE); Perceived efficiency (PFI); IS continuance intention (CI); Satisfaction (SAT).

The moderator variable (construct) can impact the relationship between the exogenous and endogenous latent variables in terms of magnitude or direction (Hair et al., 2017). There are three possible scenarios when it comes to the **moderation effect** (Dardas & Ahmad, 2015):

- (1) The effect of the predictor variable on the outcome (variable) is increased
- (2) The effect of the predictor variable on the outcome is decreased
- (3) The effect of the predictor variable on the outcome is reversed.

The major distinction from examining the mediating effect is that the moderator variable does not depend on the exogenous latent variable. As shown in Figure 16 and Figure 17, nor the level of computer skills nor the duration of use (in hours per week) depends on the satisfaction, but rather potentially moderates its relationship with continuance intention, as stated in the hypotheses.

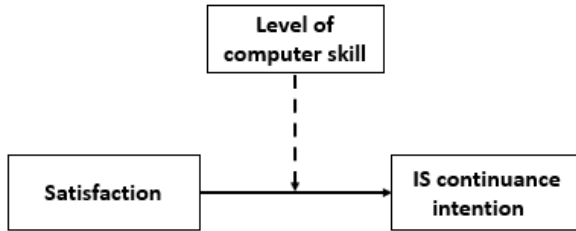

Figure 16. SAT -> CI relationship moderated by level of a computer skill

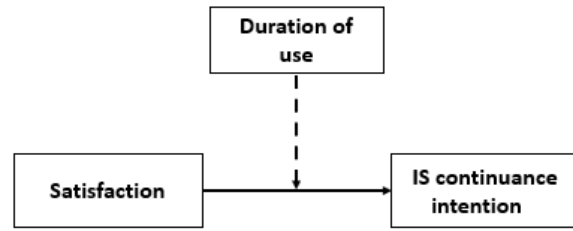

Figure 17. SAT -> CI relationship moderated by the duration of use

In PLS-SEM, the moderator variables require to incorporate an **interaction term** that explains the interrelatedness between the moderator and the exogenous latent variable (Hair et al., 2017). The interaction term was created by applying the two-stage method because it is suitable for identifying the necessary statistical significance of the moderators which are formative (Hair et al., 2017). This was followed by calculating the moderator's effect size. It was found that reported effect sizes in tests of moderation are somewhat lower than in tests of structural model relationship (Kenny, 2018). Consequently, the moderator's effect size was evaluated against a more "optimistic" standard of 0.005, 0.01 and 0.025 for small, medium, and large effects, respectively (Kenny, 2018).

The level of computer skill (CSL) was assessed as a moderating variable in the relationship between satisfaction and continuance intention (*H3*). The results showed a low and negative, but insignificant moderation effect on this relationship ($\beta=-0.01$; $p>0.05$). The 95% bias-corrected bootstrap confidence interval of the interaction term's (SAT \times CSL) effect was [-0.074, 0.050] which additionally confirmed the insignificance of the effect since the range included zero (Hair et al., 2017). The computed moderator's f^2 effect size was 0.000 indicating no effect on the path between SAT and CI whereas their simple effect (0.38) remained unchanged (see Table 29 for standardized coefficients). Figure 18 shows the structural model with the level of computer skill (CSL) as a moderator.

Further, it was examined the influence of the moderator variable, duration of use (number of hours per week), on the relationship between satisfaction and continuance intention to use the CRISS platform (*H2*). The results suggested a low but positive moderation effect on SAT and CI relationship ($\beta=0.03$). However, the computed p-value of 0.47 is greater than 0.05 for the path

linking the interaction term (SAT × DUR) and continuance intention. Additionally, the 95% bias-corrected bootstrap confidence interval of the interaction term's effect was [-0.043,0.098], thus confirming the insignificance of the effect. The moderator's f^2 effect size was 0.002 indicating no effect on the path between SAT and CI. The simple slope plots (produced in SmartPLS) were not analysed because of insignificant p-values for both moderator variables. Figure 19 shows the structural model with the duration of use (DUR) as a moderator. **Data shown in Table 31 did not support hypotheses H3 and H4:**

H3. Level of computer skill moderates the relationship between satisfaction and continuance intention to use the system for acquisition and evaluation of digital competences. **(Rejected)**

H4. Duration of use (number of hours per week) moderates the relationship between satisfaction and continuance intention to use the system for acquisition and evaluation of digital competences. **(Rejected)**

Table 31. Summary of the hypotheses (H3. and H4.)

Hypothesized paths	Direct effect	Indirect effect ^a	SD ^b	t-values ^c	p-values ^d	Interpretation
<i>H3.</i> SAT×CSL→CI	SAT→CI (β=0.38; t=6.08; p=0.00) sig.	-0.01	0.03	0.39	0.70	Non-significant (Rejected)
<i>H4.</i> SAT×DUR→CI	SAT→CI (β=0.37; t=5.84; p=0.00) sig.	0.03	0.04	0.72	0.47	Non-significant (Rejected)

Note: ^a Bootstrapping(c) with 5,000 samples (two-tailed test); ^b Standard deviation (SD); ^c t>1.96 (sig. level=5%);

^d *p<0.05; **p<0.01. Satisfaction (SAT); Level of computer skill (CSL); Duration of use-number of hours per week (DUR); IS continuance intention (CI).

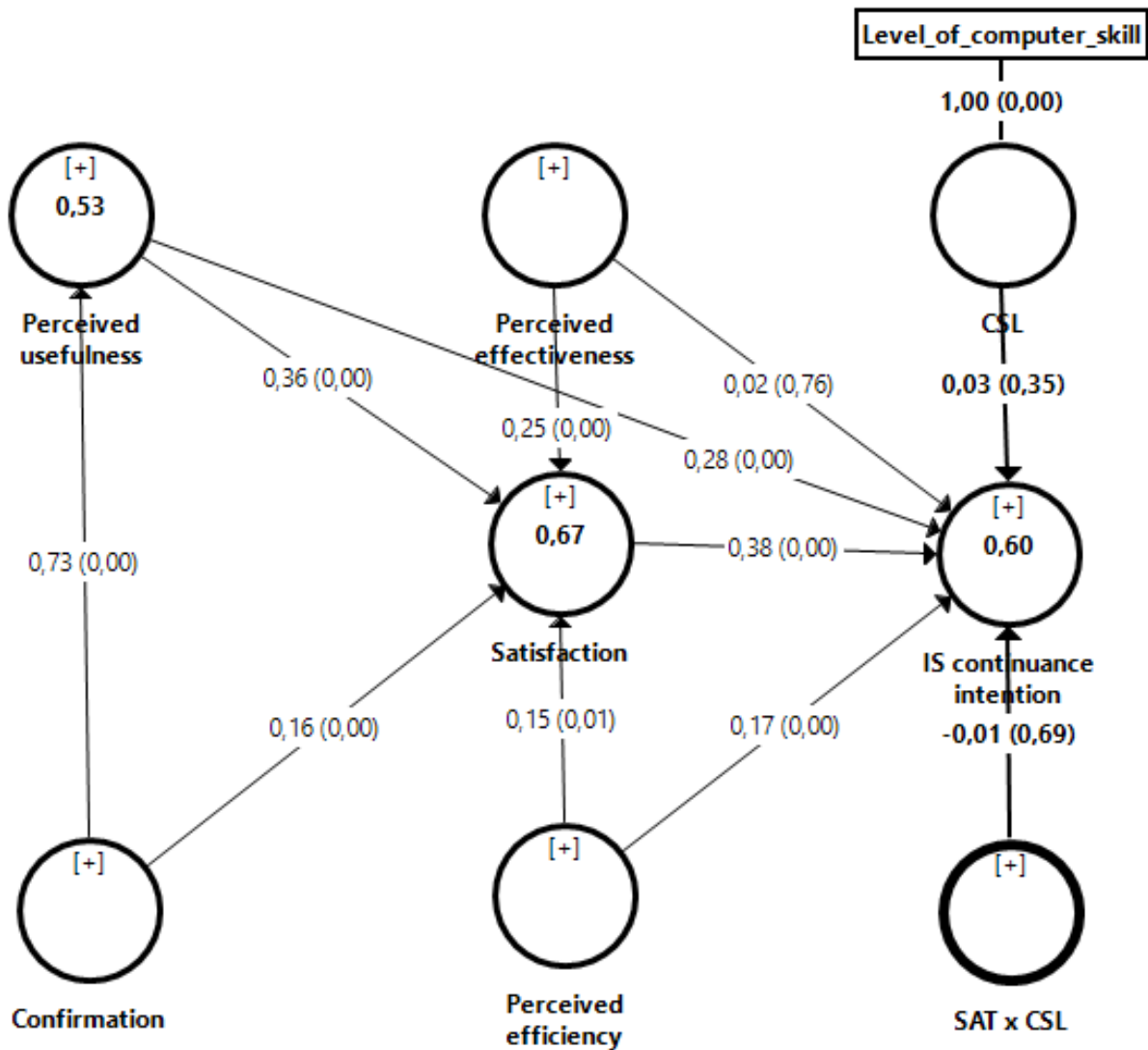

Figure 18. Structural model (Moderator: *Level of computer skill*; Inner model: path coefficients and p-values; Constructs: R Square)

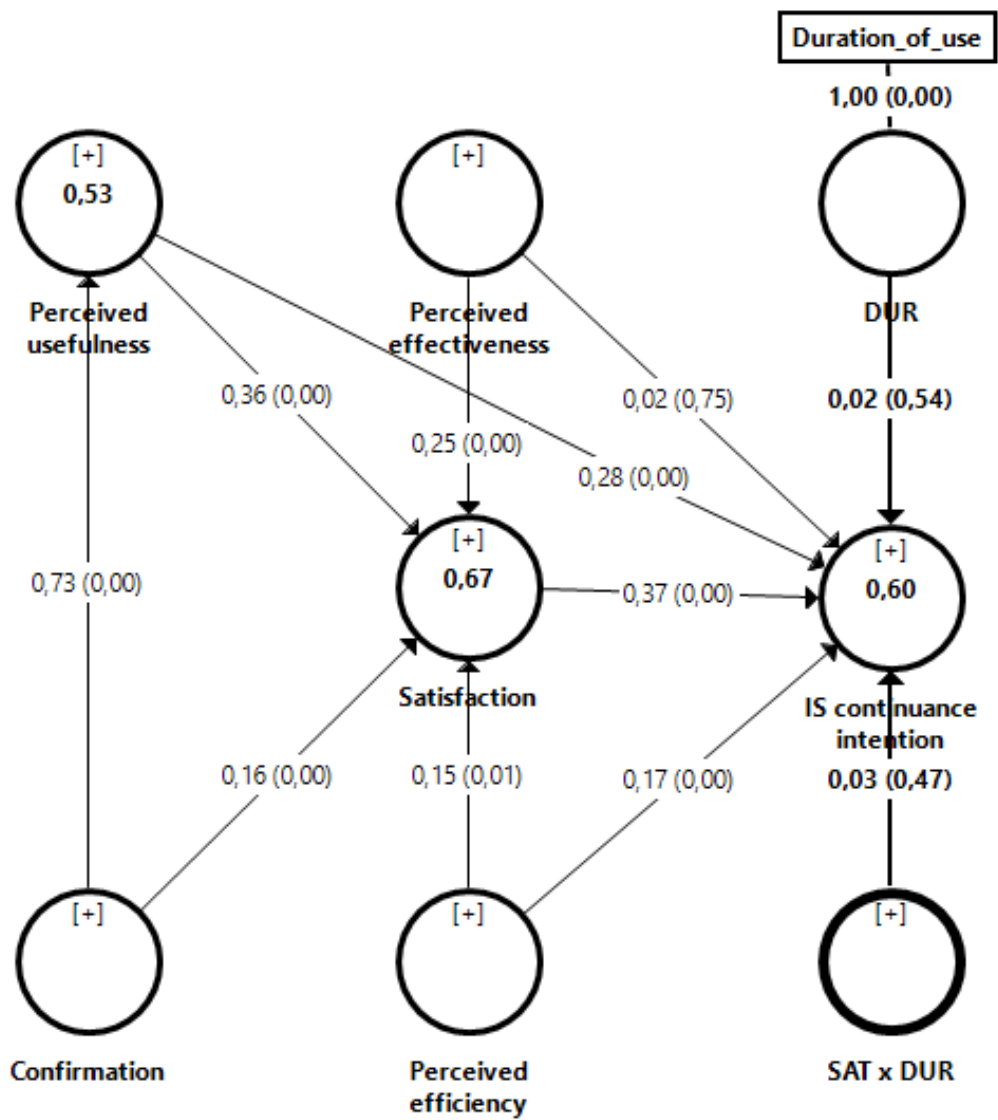

Figure 19. Structural model (Moderator: *Duration of use*; Inner model: path coefficients and p-values; Constructs: R Square)

6 DISCUSSION OF RESULTS

The previous chapter presents the results of data analysis that are systematically interpreted here to be able to generate findings that will increase knowledge in the field of IS and HCI. With this in mind, a short overview of the conducted research is provided in Table 32. This was done by suggestions from Urbach and Ahlemann (2010).

Table 32. An overview of the research

Phase	Activities and Results
<p>Problem definition and research design</p>	<p>Research question</p> <ul style="list-style-type: none"> • What are the most important variables in determining the continuance intention to use the system for acquisition and evaluation of digital competences? <p>Research design</p> <ul style="list-style-type: none"> • Identification in the literature the expectation-confirmation models that are extended with usability constructs • Development of the research model for measuring the continuance intention to use the CRISS platform • Development of a valid instrument for measuring the continuance intention to use the CRISS platform • Determination of cause-and-effect relationships between variables of an extended research model using the method of SEM
<p>Theoretical foundation</p>	<p>Literature review (September – December 2020)</p> <ul style="list-style-type: none"> • Eight scientific databases • Identified 605 studies • Analysed 15 studies (key prerequisites: had empirical findings; applied one or more constructs of ECM (Baker-Eveleth & Stone, 2015) and usability within their research model; had to cite Bhattacharjee (2001) as one of the sources for the development of their research model)
<p>Model construction and instrument development</p>	<p>Structural model</p> <ul style="list-style-type: none"> • Six constructs from both ECM (Bhattacharjee, 2001) and usability norm (ISO 9241-11, 2018): <i>perceived effectiveness, perceived efficiency, satisfaction, IS continuance intention, perceived usefulness and confirmation</i> <p>Measurement model</p> <ul style="list-style-type: none"> • Initially, 46 items based on theoretical findings in the field of IS and HCI • Content validity (11 experts; four focus groups) • Finally, 29 items (reflective indicators)

	<ul style="list-style-type: none"> Measured with a five-point scale of attitudes (agreement/disagreement; expectation on system performance) <p>Instrument: An online survey instrument</p> <p>Pre-test: Eight primary and secondary school teachers</p>
Data collection (Full-scale testing)	<p>Period: April 29, 2019 – June 30, 2019</p> <p>Target: 1.102 emails with the link to an online survey distributed to primary and secondary school teachers across six countries (Croatia, Greece, Italy, Romania, Spain and Sweden)</p> <p>Return: 353 completed surveys (223 in the first round; 130 in the second round)</p> <p>Quality assessment: Evaluated measures of shape (reasonably normal distribution)</p>
Model validation	<p>Validation of measurement model</p> <ul style="list-style-type: none"> Calculated CA and CR (Reliability) Calculated indicator loadings and AVE (Convergent validity) Calculated cross-loadings, Fornell-Larcker Criterion and HTMT (Discriminant validity) <p>Assessed model fit</p> <ul style="list-style-type: none"> Ensured construct validity <p>Validation of the structural model</p> <ul style="list-style-type: none"> Calculated VIF, R², f², Q² and q² Assessed relevance and significance of path coefficients Assessed mediators' and moderators' effects
Interpretation	<p>Discussion</p> <ul style="list-style-type: none"> Evaluated four hypotheses (<i>H1-H4</i>) Provided an answer to the research question Reasoned theoretical and managerial implications Elaborated limitations Suggested further research

The aim of the thesis was fulfilled and the research question was answered by **achieving four stated objectives**: to identify in the literature expectation-confirmation models that are extended with usability constructs (**RO₁ achieved in 2.3.2 Synthesis of Findings**), to develop the research model for measuring the continuance intention to use the system for acquisition and evaluation of digital competences (**RO₂ achieved in 3.2 Hypotheses Development**), to develop a valid instrument for measuring the continuance intention to use the system for acquisition and evaluation of DC

(**RO₃ achieved in 4.3 Instrument Development and 5.3 Measurement Model Assessment**), and to determine the cause-and-effect relationships between variables of an extended research model using the method of structural equation modelling (SEM) (**RO₄ achieved in 5.5 Structural Model Assessment**). The last achieved objective provided measurable results which are discussed regarding the main aim of the thesis, research question and hypotheses. The results are also interpreted against the literature findings.

6.1 Findings in Relation to the Aim and Research Question

The **main aim of the thesis** was to determine the extent to which perceived usability impacts the users' continuance intention to use the system for acquisition and evaluation of DC within primary and secondary education. On the other hand, the **research question** is defined to address the variables that are most important in determining the continuance intention to use the system for acquisition and evaluation of DC within primary and secondary education (the CRISS platform).

The results of the survey analysis showed that the construct of expectation confirmation was rated the worst on average (2.44), and the construct of perception of effectiveness the best (3.38). Given the five-point scale used, it can be concluded that the **system was somewhat below user expectations**. Users generally had a more positive but restrained attitude towards other elements (constructs) that were examined through the instrument survey.

Item analysis found that the **perceived effectiveness** was rated highest in terms of completeness of the information (3.47) and finding the desired option (3.43). The speed of finding information (3.37) and easy-to-read text (4.01) are among the highest-rated elements of **perceived efficiency**. Regarding **continuance use intention**, the highest score was related to the statement regarding the use of the system with traditional means of teaching (3.29). **Satisfaction** with all elements was rated very similarly in the range of 3.23 to 3.33 in terms of recommendation to other teachers, satisfaction with the platform and working on it, and how it facilitates teaching. The greatest **perceived usefulness** of the system that users have seen is that it is useful for teaching. Although the values were low, **confirmation** of expectations was generally the highest in terms of platform layout and monitoring student progress. These results can pinpoint the shortcomings of this system

and target the needs of users and can serve as a list of recommendations for the improvement or development of new ones.

As shown in Figure 20, the **results confirmed the original ECM model** (see Figure 2 in sub-chapter 2.1) in the context of the CRISS platform.

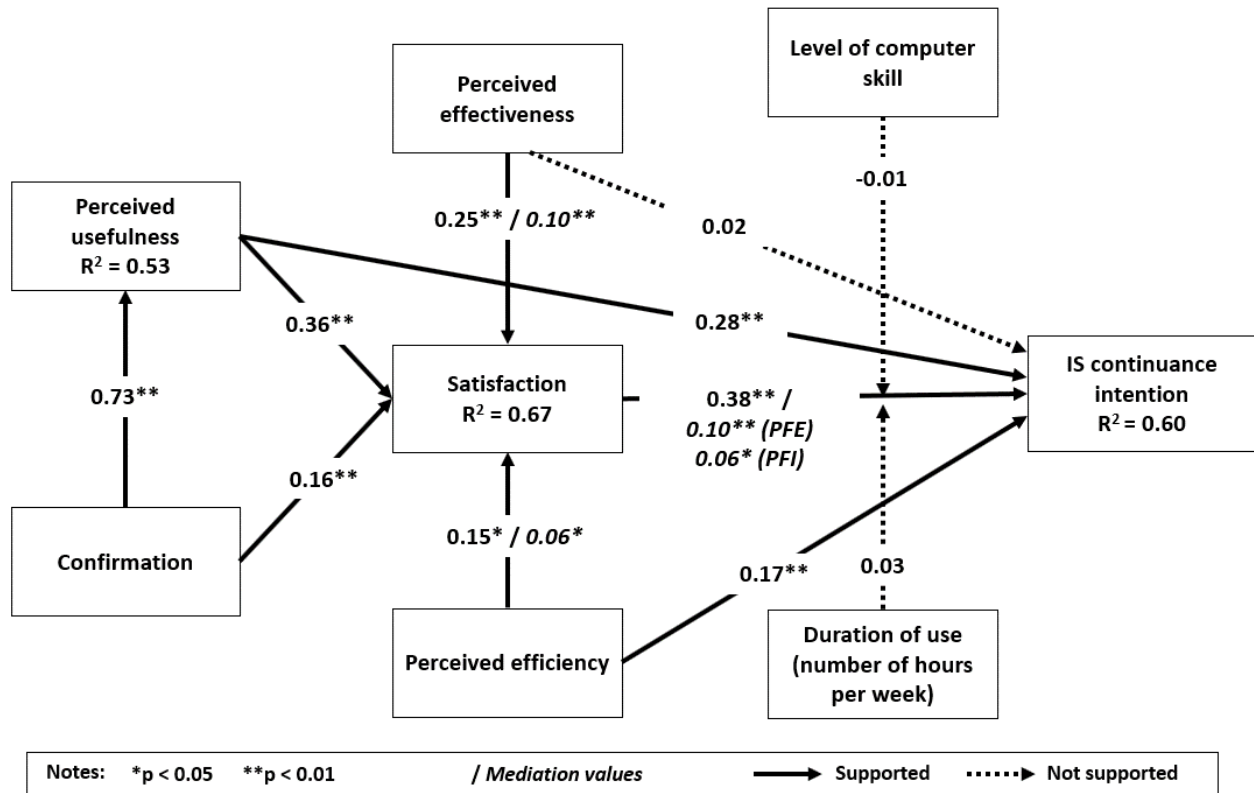

Figure 20. Structural path results

All paths were statistically significant at a 1% level. These results corroborate the findings from previous studies on ECM, see e.g. (Baker-Eveleth & Stone, 2015). Four paths were newly added to the proposed usability-extended ECM. Results indicated that one path (PFE→CI) was insignificant, while others were statistically significant at a 1% and a 5% level. Presumably, the effects of perceived usefulness and satisfaction on IS continuance intention affected this insignificant relationship. In fact, when the perceived usefulness-continuance intention path was removed, the effect of perceived effectiveness increased to 0.11 but remained insignificant. After the satisfaction-continuance intention path was removed, the effect of perceived effectiveness increased to 0.36 and became significant (p<0.01). However, these results suggested that satisfaction, perceived usefulness and perceived efficiency, are more important predictors of

continuance intention than perceived effectiveness. The strongest impact had the satisfaction (0.38), then perceived usefulness (0.28) and perceived efficiency (0.17). Of these, satisfaction and perceived efficiency are variables of perceived usability. In the context of the CRISS platform, satisfaction showed that it is highly regarded as it was in the initial setup of the original ECM (Bhattacharjee, 2001). This relationship is consistent across the literature (Daghan & Akkoyunlu, 2016).

From the usability aspect, teachers' perception of invested time, mental or physical effort in using the CRISS platform is more important in predicting their continuance intention than the perception of accurate and complete achievement of specific goals through the CRISS platform. Given that there are already a large number of IT tools and services in education through which teachers achieve the set teaching goals, another one like the CRISS platform will not influence their decision to continue using it. Baker-Eveleth and Stone (2015) name it "familiarity with the use" that, in some cases as such, can cause the insignificance of the relationship. Nitzl et al. (2016) also state that the reason for no direct effect of the variable could be due to the intermediate role of a third variable. In this case, this proved to be correct, and it was discussed in the following sub-chapter.

However, how fast and easily will they complete the tasks in the systems, will influence their continuance use behaviour towards the CRISS platform. This is also in line with the findings (Daghan & Akkoyunlu, 2016; Hong et al., 2006; Oghuma et al., 2016; Pee et al., 2018) supporting a significant relationship between usability and continuance intention. By contrast, Kim et al. (2019) conclude that the insignificant perceived usability-continuance intention path is not that peculiar in the studies.

Perceived usefulness, confirmation, perceived effectiveness and perceived efficiency had **significant effects on satisfaction**. The relatively stronger effect of perceived usefulness on satisfaction compared to one of the usability variables can be found for IT applications and tools that are used regularly to perform job-related tasks (Najmul Islam et al., 2017). In this context, teachers used the CRISS platform for job-related tasks such as assigning tasks to students through different competence scenarios based on which they would later evaluate them.

A confirmation has a strong effect on **perceived usefulness**, and this is the largest path with the coefficient of 0.73 in the model. It follows that teachers' expectations will have a significant impact

on their perception of outcomes (benefits) already at the first experience of working with the system. Both, confirmation of expectations and perceived usefulness of the system had a significant impact on the satisfaction with use which is in line with findings (C. P. Chen et al., 2015; Eveleth et al., 2015; Nascimento et al., 2018).

The **extended model** accounted for 60% of the variance in users' continuance intention to use, 67% of the variance in user satisfaction and 53% of the variance in perceived usefulness. The **explanatory power** of a proposed model is higher than in other studies, e.g. (Hong et al., 2006; Najmul Islam et al., 2017; Nascimento et al., 2018). The mediation role of satisfaction, which will be further discussed, contributed to the amount of its variance explained by confirmation, perceived usefulness, perceived effectiveness and perceived efficiency. Hong et al. (2006) state that the explained variances may also increase over time given the user experience gained within the system, especially if such systems are still in the infantile stage of development as is the case with the CRISS platform.

6.2 Findings in Relation to the Hypotheses

In the thesis, four hypotheses are proposed, of which the first two predict mediation influence and the other two mediator influence. The results of testing the relationships between the constructs **supported the H1 and H2** hypotheses, while **H3 and H4 refuted them** (see Figure 20). The first two hypotheses are set as follows:

H1. Satisfaction mediates the relationship between perceived effectiveness and continuance intention to use the system for acquisition and evaluation of digital competences.

H2. Satisfaction mediates the relationship between perceived efficiency and continuance intention to use the system for acquisition and evaluation of digital competences.

Results indicated that **satisfaction fully mediated** the effect of perceived effectiveness on continuance intention since their direct relationship is weak and non-significant. In the case of perceived efficiency, **satisfaction had a complementary partial mediation**, because both direct and indirect effects are significant and point in the same direction. Although the studies mostly study the direct effects of variables (Nitzl et al., 2016), certain findings support the mediating role of satisfaction between usability and continuance intention. For instance, Baker-Eveleth and Stone

(2015) found that effectiveness and efficiency as dimensions of usability indirectly impact continuance intention through satisfaction in the context of e-textbooks. The same conclusion was drawn in the context of a jobseekers website (Eveleth et al., 2015). The time or effort (efficiency) that the system will require from the user will partly affect their level of satisfaction and decision to continue using it. However, how it will help them achieve their teaching tasks or goals will fully affect their satisfaction and then the intention of continuance use. People, who have high computer skills, have a high level of computer self-efficacy, result high in the use of a computer (Pellas & Kazanidis, 2014).

Hypotheses H₃ and H₄ are set as follows:

H3. Level of computer skill moderates the relationship between satisfaction and continuance intention to use the system for acquisition and evaluation of digital competences.

H4. Duration of use (number of hours per week) moderates the relationship between satisfaction and continuance intention to use the system for acquisition and evaluation of digital competences.

Contrary to the hypotheses, **no moderator influence** was found on the level of computer skill and duration of use on the relationship between satisfaction and continuance intention. Statistically, both hypotheses were disconfirmed.

Teachers subjectively assessed their level of computer skill against a predetermined scale taken from the ICAS Framework (University of New South Wales (UNSW), n.d.). Over 80% of them reported having intermediate, advanced and proficient computing and applications skills. Presumably, teachers are experienced users of computer systems regarding their subjective assessment of skill level. However, the level of skills at their disposal will not affect the relationship between satisfaction and continuance intention in the context of the CRISS platform - this relationship will remain as strong for teachers with a lower level of skills as for those with a higher level of skills. These findings are in contradiction with the studies claiming that the satisfaction-continuance intention link was stronger in the case of less experienced users (K. M. Lin, 2011; Pee et al., 2018). However, the research has also shown that continuance intention decreases even when users were somewhat satisfied with prior use of the system if they lack confidence in their skills (Bhattacharjee et al., 2008).

Regarding the duration of use, over 70% of teachers spent two or fewer hours per week using the CRISS platform. The literature can determine that a certain number of hours spent in the system will form a habit of use (Abeyrathna & Zainab, 2004). The habit significantly moderated the relationship with continuance intention when the duration of use was longer than 14 weeks (Limayem & Cheung, 2008). In this case, over 60% of teachers used the system for less than three months. Chen et al. (2015) explain that a significant role of habit has been identified in studies with students but not with teachers. This is in line with the herein findings, indicating no relevant influence of use duration on satisfaction-continuance intention relationship.

Possible explanations for the lack of significance in both variables may be due to personal or environmental constraints that may have prevented the conduct of continuance use behaviour (J. Wu & Du, 2012). Additionally, by creating a habit, it is possible to significantly influence the increase in the level of satisfaction (Amoroso & Lim, 2017), or in the opposite case, such influence may be absent. Such a sequence of circumstances where teachers did not acquire the habit of using the system because they knew that they were participating in a time-limited project, could justify the insignificance of the connection.

7 CONCLUSION

Considerable research has been done to increase the understanding of the CRISS platform continuance intention from the teachers' perspective. This was done by focusing on posited objectives: to identify in the literature ECM models that are extended with usability constructs, to develop the research model and a valid instrument for measuring the continuance intention to use the system for acquisition and evaluation of digital competence (DC), and to determine the cause-and-effect relationships between variables of an extended research model using the method of structural equation modelling (SEM). By fulfilling the aforementioned objectives, the research question was answered. Findings provided solid support for the theoretical relationships posited in the original ECM. The continuance intention to use the CRISS platform was directly driven by teachers' levels of satisfaction, perceived usefulness and perceived efficiency, and indirectly through satisfaction by perceived effectiveness. However, it was shown that the level of computer skill and duration of use (in hours per week) does not moderate the satisfaction-continuance intention relationship. The possible reasons for the insignificant interaction effect were discussed in the previous chapter. Theoretical and practical contributions of the thesis are discussed below, followed by limitations and future directions.

7.1 Contribution

The literature review revealed a lack of studies that examine user behaviour after the adoption of a particular IS, and especially, in relation to the usability of systems that support teaching and learning processes. This thesis attempted to provide a deeper understanding of identified phenomena.

7.1.1 Theoretical Contribution

The undertaken scientific approach and conducted research made important theoretical contributions. First, grounded in the recent ISO 9241-11 norm (ISO 9241-11, 2018) supported by Bevan et al. (2016) findings, the thesis candidate derived three constructs (perceived effectiveness, perceived efficiency and satisfaction) as representations of the perceived usability, which served as antecedents of continuance intention. These three constructs were incorporated within the

original ECM of Bhattacharjee (Bhattacharjee, 2001), except for the satisfaction construct being only theoretically extended. Consequently, a usability-extended ECM model was developed to be tested in the context of the system for acquisition and evaluation of DC (referred to as the *CRISS platform* in the thesis). A conducted review of the literature did not detect that such or similar systems were tested by the extended ECM model, this was the first such attempt. Furthermore, this model also bridged the IS and HCI literature by examining the impacts of perceived usability on the continuance intention.

Second, a related survey instrument was developed to measure teachers' continuance intention to use the system for acquisition and evaluation of DC. The instrument measures were assessed as reliable and valid in tests for internal consistency, convergent and discriminant validity.

Third, findings shed a light on the important role of usability in determining teachers' continuance intention to use. As noted, continuance intention is directly driven by teacher's levels of satisfaction, perceived usefulness and perceived efficiency, and indirectly through satisfaction by perceived effectiveness. Hence, a mediation role of satisfaction in relationships of other usability variables (perceived effectiveness and perceived efficiency) with continuance intention was identified. This contributed to the studies that investigated mediation effects in the structural model since most often one can only find analyses of direct influences among variables (Nitzl et al., 2016). Even though moderator effects were disconfirmed, they were included in the research which is in line with the suggestion from Sun and Zhang (2006). This attempt also expanded the existing continuance intention theory where tests on teachers produced the same nonsignificant results, see e.g. Chen et al. (2015).

7.1.2 Practical Contribution

The obtained results also have practical implications in addition to theoretical contributions.

First, the results contributed to the understanding of teachers' adoption and use of the system for acquisition and evaluation of DC. Specifically, teachers' confirmation of expectation influence both their perception of usefulness and level of satisfaction which in turn impacts continuous intention to use the *CRISS platform*. In a practical sense, teachers' perception of usefulness, satisfaction and perceived efficiency will impact their decision on continued use. Therefore, those

are the variables that have to be taken into consideration while developing or improving systems for the acquisition and evaluation of DC. Furthermore, Al-Adaileh (2009) highlight the importance of involving end-users in the development of specific IS. This approach contributes to their more positive attitude, and the sustainability of the system is prolonged.

Second, results can help primary and secondary schools to better understand and manage the trend of implementing the system for acquisition and evaluation of DC and related costs through identified predictors of teachers' continuance intention.

Third, the systems for the acquisition and evaluation of DC are mostly conceptually researched and in non-formal educational contexts, but never from the usability aspect. Therefore, this empirical research contributed to the relevant body of knowledge.

7.2 Limitations and Future Research

Finally, several potential limitations need to be considered, which also creates the opportunity for future research.

As Gelderblom et al. (2019) point out, quantitative instruments are very limited since they often have difficulty identifying problems that users have encountered while working in the system and how their attitudes are formed. In this aspect, in-depth interviews can be employed for further research of systems for the acquisition and evaluation of DC.

The instrument content validity was performed only with the help of experts and teachers who participated in the project that developed the CRISS platform, and there is a possibility that the instrument is limited by their experience primarily focused on education. Future studies could evaluate the instrument using practitioners from the industry, especially HCI.

For this research, the judgement (nonprobability) sampling was chosen since the CRISS platform is one of the first attempts to implement DC in learning and teaching processes and teachers who used it are the only ones who can provide relevant information. For this reason, their responses are considered as an opulent data source (Sekaran and Bougie, 2016, p.248). However, the generalizability of this thesis is limited due to a nonprobability sample of teachers located in Europe and used to verify the research model, although the demographic data analysed largely overlap with statistics related to European teachers in primary and secondary schools. In this thesis, there

were not enough respondents to conduct the research at the individual level of each country. Future studies may target teachers in only one country, as responses might otherwise be culturally conditioned.

As users get more experienced with the system, the model's results might change. Future research would benefit from examining users' perceptions after a year of system use. That way, users could become more experienced or develop a habit of use which can potentially impact the continuance intention to use (Chou & Hsu, 2016).

Future research could study affective measures (e.g. aesthetics, playfulness) or user experience measures as predictors of user satisfaction and continuance intention since effectiveness and efficiency have not maximized the variance of satisfaction (Coursaris & Van Osch, 2016; Hornbæk & Hertzum, 2017). On the other hand, usability can be studied in relation to confirmation of expectations to identify critical usability problems in the system (Sackl et al., 2017).

REFERENCES

- Abeyrathna, P. H. A. S., & Zainab, A. N. (2004). The status of reading habit and interests among secondary school children in Sri Lanka. *Malaysian Journal of Library and Information Science*, 9(2), 109–123.
- Abran, A., Khelifi, A., Suryan, W., & Seffah, A. (2003). Usability meanings and interpretations in ISO standards. *Software Quality Journal*, 11(4), 325–338. <https://doi.org/10.1023/A:1025869312943>
- Ajzen, I. (1991). The theory of planned behavior. *Organizational Behavior and Human Decision Processes*, 50(2), 179–211. [https://doi.org/10.1016/0749-5978\(91\)90020-T](https://doi.org/10.1016/0749-5978(91)90020-T)
- Al-Adaileh, R. M. d. (2009). An evaluation of information systems success: A user perspective - the case of Jordan telecom group. *European Journal of Scientific Research*, 37(2), 226–239.
- Al-Emran, M., Mezhuyev, V., & Kamaludin, A. (2019). PLS-SEM in Information Systems Research: A Comprehensive Methodological Reference. In *Advances in Intelligent Systems and Computing* (Vol. 845). Springer International Publishing. https://doi.org/10.1007/978-3-319-99010-1_59
- Alraimi, K. M., Zo, H., & Ciganek, A. P. (2015). Understanding the MOOCs continuance: The role of openness and reputation. *Computers and Education*, 80, 28–38. <https://doi.org/10.1016/j.compedu.2014.08.006>
- Ambalov, I. A. (2018). A meta-analysis of IT continuance: An evaluation of the expectation-confirmation model. *Telematics and Informatics*, 35(6), 1561–1571. <https://doi.org/10.1016/j.tele.2018.03.016>
- Amoroso, D., & Lim, R. (2017). The mediating effects of habit on continuance intention. *International Journal of Information Management*, 37(6), 693–702. <https://doi.org/10.1016/j.ijinfomgt.2017.05.003>
- Anderson, E. W., & Sullivan, M. W. (1993). The Antecedents and Consequences of Customer Satisfaction for Firms. *Marketing Science*, 12(2), 125–143. <https://doi.org/10.1287/mksc.12.2.125>

- Arbuckle, J. L. (2012). *Amos (Version 21.0)*. SPSS.
- Atcharyachanvanich, K., Okada, H., & Sonehara, N. (2007). Theoretical Model of Purchase and Repurchase in Internet Shopping: Evidence from Japanese Online Customers. *Ninth International Conference on Electronic Commerce*, 243–251. <https://doi.org/10.1145/1282100.1282146>
- Ayre, C., & Scally, A. J. (2013). Critical Values for Lawshe's Content Validity Ratio. *Measurement and Evaluation in Counseling and Development*, 47(1), 79–86. <https://doi.org/10.1177/0748175613513808>
- Bachman, L. F. (2004). *Statistical Analyses for Language Assessment* (1st editio). Cambridge University Press.
- Bagci, K., & Celik, H. E. (2018). Examination of factors affecting continuance intention to use web-based distance learning system via structural equation modelling. *Eurasian Journal of Educational Research*, 78, 43–66. <https://doi.org/10.14689/ejer.2018.78.3>
- Baharum, A., & Jaafar, A. (2015). User Interface Design : a Study of Expectation - Confirmation Theory. *Proceedings of the 5th International Conference on Computing and Informatics, ICOCI 2015, 064*, 17–24.
- Baker-Eveleth, L., & Stone, R. W. (2015). Usability, expectation, confirmation, and continuance intentions to use electronic textbooks. *Behaviour and Information Technology*, 34(10), 992–1004. <https://doi.org/10.1080/0144929X.2015.1039061>
- Balaban, I., Filipović, D., & Peras, M. (2019). CRISS: A cloud based platform for guided acquisition, evaluation and certification of digital competence. *Multi Conference on Computer Science and Information Systems (MCCSIS)*, 41–48.
- Bandura, A. (1986). *Social Foundations of Thought and Action: A Social Cognitive Theory*. Prentice-Hall.
- Barnes, S., & Böhringer, M. (2011). Modeling Use Continuance Behaviour in Microblogging Services: The Case of Twitter. *Journal of Computer Information Systems*, 51(4), 1–10.
- Bartolomé, J., Garaizar, P., & Larrucea, X. (2021). A Pragmatic Approach for Evaluating and

- Accrediting Digital Competence of Digital Profiles: A Case Study of Entrepreneurs and Remote Workers. In *Technology, Knowledge and Learning* (Issue 0123456789). Springer Netherlands. <https://doi.org/10.1007/s10758-021-09516-3>
- Baruch, Y., & Holtom, B. C. (2008). Survey response rate levels and trends in organizational research. *Human Relations*, *61*(8), 1139–1160. <https://doi.org/10.1177/0018726708094863>
- Baş, G., Kubiato, M., & Sünbül, A. M. (2016). Teachers' perceptions towards ICTs in teaching-learning process: Scale validity and reliability study. *Computers in Human Behavior*, *61*, 176–185. <https://doi.org/10.1016/j.chb.2016.03.022>
- Beblavý, M., Baiocco, S., Kilhoffer, Z., Akgüç, M., & Jacquot, M. (2019). *Index of Readiness for Digital Lifelong Learning: Changing How Europeans Upgrade Their Skills*. <https://www.ceps.eu/ceps-publications/index-of-readiness-for-digital-lifelong-learning/>
- Belanche, D., Casaló, L. V., & Guinalíu, M. (2012). Website usability, consumer satisfaction and the intention to use a website: The moderating effect of perceived risk. *Journal of Retailing and Consumer Services*, *19*(1), 124–132. <https://doi.org/10.1016/j.jretconser.2011.11.001>
- Bennett, J. L. (1984). Managing to meet usability requirements. In J. L. Bennett, D. Case, J. Sandelin, & M. Smith (Eds.), *Visual Display Terminals: Usability Issues and Health Concerns* (pp. 161–184).
- Bennett, J. L. (1979). The commercial impact of usability in interactive systems. In B Shackel (Ed.), *Man–Computer Communication, Infotech State of the Art Report, vol. 2*.
- Bentler, P. M., & Bonett, D. G. (1980). Significance tests and goodness of fit in the analysis of covariance structures. *Psychological Bulletin*, *88*(3), 588–606. <https://doi.org/10.1037/0033-2909.88.3.588>
- Bevan, N. (1982). Psychological and ergonomic factors in machine translation. In V. Lawson (Ed.), *Practical experience of machine translation*. North-Holland Publishing Company.
- Bevan, N. (1995). Usability is quality of use. In *Advances in Human Factors/Ergonomics* (Vol. 20, pp. 349–354).
- Bevan, N. (1997). Quality and usability : A new framework. In E. van Veenendaal & J. McMullan

- (Eds.), *Achieving software product quality*. Tutein Nolthenius, Netherlands.
- Bevan, N. (2001). International standards for HCI and usability. *International Journal of Human Computer Studies*, 55(4), 533–552. <https://doi.org/10.1006/ijhc.2001.0483>
- Bevan, N., Carter, J., Earthy, J., Geis, T., & Harker, S. (2016). New ISO Standards for Usability, Usability Reports and Usability Measures. In M. Kurosu (Ed.), *Lecture Notes in Computer Science* (Vol. 9731, Issue July, pp. 268–278). Springer.
- Bevan, N., Kirakowski, J., & Maissel, J. (1991). What is usability? In Bullinger HJ (Ed.), *Proceedings of the 4th International Conference on HCI*. (pp. 1–5). Elsevier.
- Bhattacharjee, A. (2001). Understanding Information Systems Continuance: An Expectation Confirmation Model. *MIS Quarterly*, 25(3), 351–370. <https://doi.org/10.2307/3250921>
- Bhattacharjee, A., & Barfar, A. (2011). Information Technology Continuance Research: Current State and Future Directions. *Asia Pacific Journal of Information Systems*, 21(2), 1–18. <https://doi.org/10.2307/3250921>
- Bhattacharjee, A., Perols, J., & Sanford, C. (2008). Information technology continuance: A theoretic extension and empirical test. *Journal of Computer Information Systems*, 49(1), 17–26. <https://doi.org/10.1080/08874417.2008.11645302>
- Bhattacharjee, A., & Premkumar, G. (2004). Understanding Changes in Belief and Attitude toward Information Technology Usage: A Theoretical Model and Longitudinal Test Understanding Changes in Belief and Attitude Toward Information Technology Usage: A Theoretical Model and Longitudinal Test1. *MIS Quarterly*, 28(2), 229–254. <http://www.jstor.org/stable/25148634> <http://about.jstor.org/terms>
- Boland, A., Cherry, G., & Dickson, R. (2017). *Doing a Systematic Review: A Student's Guide*. Sage.
- Braak, J. van, Tondeur, J., & Valcke, M. (2004). Explaining different types of computer use among primary school teachers. *European Journal of Psychology of Education*, 19(4), 407–422. <https://doi.org/10.1007/BF03173218>
- Brown, T. A. (2015). *Confirmatory Factor Analysis for Applied Research* (2nd ed.). The Guilford

Press.

Calero, C., Moraga, M. A., & Piattini, M. (2010). *Calidad del producto y proceso software*. RA-MA S.A. Editorial y Publicaciones.

Carretero, S., Vuorikari, R., & Punie, Y. (2017). DigComp 2.1: The Digital Competence Framework for Citizens. With eight proficiency levels and examples of use. In *Publications Office of the European Union* (pp. 1–48). [http://publications.jrc.ec.europa.eu/repository/bitstream/JRC106281/web-digcomp2.1pdf_\(online\).pdf](http://publications.jrc.ec.europa.eu/repository/bitstream/JRC106281/web-digcomp2.1pdf_(online).pdf)

Casaló, L. V., Flavián, C., & Guinalú, M. (2008). The role of satisfaction and website usability in developing customer loyalty and positive word-of-mouth in the e-banking services. *International Journal of Bank Marketing*, 26(6), 399–417. <https://doi.org/10.1108/02652320810902433>

Casillas Martín, S., Cabezas González, M., & García Peñalvo, F. J. (2019). Digital competence of early childhood education teachers: attitude, knowledge and use of ICT. *European Journal of Teacher Education*, 43(2), 210–223. <https://doi.org/10.1080/02619768.2019.1681393>

Chao, J.-Y., Chao, S.-J., Lo-Yi, Y., & Liu, C.-H. (2016). A Case Study of Design and Usability Evaluation of the Collaborative Problem Solving Instructional Platform System. *EURASIA Journal of Mathematics, Science & Technology Education*, 12(10), 2647–2655. <https://doi.org/10.12973/eurasia.2016.1278a>

Chen, C. P., Lai, H. M., & Ho, C. Y. (2015). Why do teachers continue to use teaching blogs? the roles of perceived voluntariness and habit. *Computers and Education*, 82(1), 236–249. <https://doi.org/10.1016/j.compedu.2014.11.017>

Chen, Z. (2001). Further investigation of the outcomes of loyalty to supervisor. *Journal of Managerial Psychology*, 16(8), 650–660. <https://doi.org/10.1108/EUM0000000006305>

Cheng, Y.-M. (2014a). Extending the expectation-confirmation model with quality and flow to explore nurses' continued blended e-learning intention. In *Information Technology & People* (Vol. 27, Issue 3). <https://doi.org/10.1108/ITP-01-2013-0024>

Cheng, Y.-M. (2014b). Why do users intend to continue using the digital library? An integrated

- perspective. *Aslib Journal of Information Management*, 66(6), 640–662.
<https://doi.org/http://dx.doi.org/10.1108/MRR-09-2015-0216>
- Chin, W. W. (1998). The partial least squares approach to structural equation modeling. In G. A. Marcoulides (Ed.), *Modern methods for business research* (pp. 295–336). Lawrence Erlbaum Associates.
- Chiu, C. M., Hsu, M. H., Sun, S. Y., Lin, T. C., & Sun, P. C. (2005). Usability, quality, value and e-learning continuance decisions. *Computers and Education*, 45(4), 399–416.
<https://doi.org/10.1016/j.compedu.2004.06.001>
- Chou, S.-W., & Hsu, C.-S. (2016). Understanding online repurchase intention: social exchange theory and shopping habit. *Information Systems and E-Business Management*, 14(1), 19–45.
<https://doi.org/10.1007/s10257-015-0272-9>
- Churchill, G. A., & Surprenant, C. (1982). An Investigation into the Determinants of Customer Satisfaction. *Journal of Marketing Research*, 19(4), 491–504.
<https://doi.org/10.1177/002224378201900410>
- Cohen, L., Manion, L., & Morrison, K. (2018). *Research Methods in Education* (8th ed.). Routledge.
- Cordero, D., & Mory, A. (2019). Education in System Engineering: Digital Competence. 2019 *IEEE 6th International Conference on Industrial Engineering and Applications, ICIEA 2019*, 677–681. <https://doi.org/10.1109/IEA.2019.8715223>
- Council of the European Union. (2018). Council Recommendation of 22 May 2018 on Key Competences for Lifelong Learning. *Official Journal of the European Union*, 1–13.
- Coursaris, C. K., Hassanein, K., Head, M. M., & Bontis, N. (2012). The impact of distractions on the usability and intention to use mobile devices for wireless data services. *Computers in Human Behavior*, 28(4), 1439–1449. <https://doi.org/10.1016/j.chb.2012.03.006>
- Coursaris, C. K., & Van Osch, W. (2016). A Cognitive-Affective Model of Perceived User Satisfaction (CAMPUS): The complementary effects and interdependence of usability and aesthetics in IS design. *Information and Management*, 53(2), 252–264.
<https://doi.org/10.1016/j.im.2015.10.003>

- Cox, K., & Walker, D. (1993). *User-interface design*. Prentice Hall.
- Creswell, J. W. (2014). *Research design: Qualitative, Quantitative and Mixed Methods Approaches* (4th ed.). SAGE Publications, Inc.
- Cyr, D. (2008). Modeling Web Site Design Across Cultures: Relationships to Trust, Satisfaction, and E-Loyalty. *Journal of Management Information Systems*, 24(4), 47–72. <https://doi.org/10.2753/MIS0742-1222240402>
- Dabholkar, P. A., Shepherd, C. D., & Thorpe, D. I. (2000). A comprehensive framework for service quality: an investigation of critical conceptual and measurement issues through a longitudinal study. *Journal of Retailing*, 76(2), 139–173. [https://doi.org/10.1016/S0022-4359\(00\)00029-4](https://doi.org/10.1016/S0022-4359(00)00029-4)
- Daghan, G., & Akkoyunlu, B. (2016). Modeling the continuance usage intention of online learning environments. *Computers in Human Behavior*, 60, 198–211. <https://doi.org/10.1016/j.chb.2016.02.066>
- Danner, U. N., Aarts, H., & De Vries, N. K. (2008). Habit vs. intention in the prediction of future behaviour: The role of frequency, context stability and mental accessibility of past behaviour. *British Journal of Social Psychology*, 47(2), 245–265. <https://doi.org/10.1348/014466607X230876>
- Daramola, O., Oladipupo, O., Afolabi, I., & Olopade, A. (2017). Heuristic evaluation of an institutional E-learning system: A Nigerian case. *International Journal of Emerging Technologies in Learning*, 12(3), 26–42. <https://doi.org/10.3991/ijet.v12i03.6083>
- Dardas, L. A., & Ahmad, M. M. (2015). For fathers raising children with autism, do coping strategies mediate or moderate the relationship between parenting stress and quality of life? *Research in Developmental Disabilities*, 36, 620–629. <https://doi.org/10.1016/j.ridd.2014.10.047>
- Davis, F. D. (1989). Perceived Usefulness, Perceived Ease of Use, and User Acceptance of Information Technology. *MIS Quarterly*, 13(3), 319–340. <https://doi.org/10.2307/249008>
- De Guinea, A. O., & Markus, L. (2009). Why break the habit of a lifetime? Rethinking the roles of intention, habit, and emotion in continuing information technology use. *MIS Quarterly: Management Information Systems*, 33(3), 433–444. <https://doi.org/10.2307/20650303>

- Denscombe, M. (2014). *The good research guide: for small-scale social research projects* (5th ed.). Open University Press. <https://doi.org/http://hdl.handle.net/2086/10239>
- Dybå, T., Dingsøy, T., & Hanssen, G. K. (2007). Applying systematic reviews to diverse study types: An experience report. *Proceedings - 1st International Symposium on Empirical Software Engineering and Measurement, ESEM 2007*, 225–234. <https://doi.org/10.1109/ESEM.2007.21>
- Eason, K. D. (1984). Towards the experimental study of usability. *Behaviour and Information Technology*, 3(2), 133–143. <https://doi.org/10.1080/01449298408901744>
- Engelbrecht, L., Landes, D., & Sedelmaier, Y. (2018). A Didactical Concept for Supporting Reflection in Software Engineering Education. *IEEE Global Engineering Education Conference (EDUCON)*, 547–554.
- European Commission/EACEA/Eurydice. (2013). *Key Data on Teachers and School Leaders in Europe: Vol. Eurydice R* (2013th ed.).
- European Commission. (2019). *2nd Survey of Schools: ICT in Education*. <https://ec.europa.eu/digital-single-market/en/news/survey-schools-ict-education>
- Eurostat. (2016). Women teachers largely over-represented in primary education in the EU. *Eurostat*, 189, 1–5. <http://ec.europa.eu/eurostat/documents/2995521/7672738/3-04102016-BP-EN.pdf/9f0d2d04-211a-487d-87c3-0a5f7d6b22ce>
- Eveleth, D. M., Baker-Eveleth, L. J., & Stone, R. W. (2015). Potential applicants' expectation-confirmation and intentions. *Computers in Human Behavior*, 44, 183–190. <https://doi.org/10.1016/j.chb.2014.11.025>
- Federici, S., & Borsci, S. (2010). Usability evaluation: models, methods, and applications. In *International Encyclopedia of Rehabilitation*. Center for International Rehabilitation Research Information and Exchange (CIRRIE).
- Ferrari, A. (2012). Digital Competence in Practice: An Analysis of Frameworks. *Joint Research Centre of the European Commission*, 91. <https://doi.org/10.2791/82116>
- Field, A. (2009). *Discovering Statistics Using SPSS* (3rd editio). SAGE Publications Ltd.

- Finstad, K. (2010). Interacting with Computers The Usability Metric for User Experience. *Interacting with Computers*, 22(5), 323–327. <https://doi.org/10.1016/j.intcom.2010.04.004>
- Fishbein, M., & Ajzen, I. (1975). *Belief, Attitude, Intention and Behavior: An introduction to theory and research*. Addison-Wesley.
- Flavián, C., Guinalú, M., & Gurrea, R. (2006). The role played by perceived usability, satisfaction and consumer trust on website loyalty. *Information & Management*, 43(1), 1–14. <https://doi.org/10.1016/j.im.2005.01.002>
- FrØkjaer, E., Hertzum, M., & Hornbæk, K. (2000). Measuring usability: Are effectiveness, efficiency, and satisfaction really correlated? *Conference on Human Factors in Computing Systems - Proceedings*, 345–352. <https://doi.org/10.1145/332040.332455>
- Fuller, T. D., Edwards, J. N., Vorakitphokatorn, S., & Sermsri, S. (1993). Using Focus Groups to Adapt Survey Instruments to New Populations: Experience from a Developing Country. In D. L. Morgan (Ed.), *Successful Focus Groups: Advancing the State of the Art* (pp. 89–104). SAGE Publications, Inc. <https://doi.org/10.4135/9781483349008>
- Gefen, D., & Straub, D. (2005). A Practical Guide To Factorial Validity Using PLS-Graph: Tutorial And Annotated Example. *Communications of the Association for Information Systems*, 16. <https://doi.org/10.17705/1CAIS.01605>
- Gelderblom, H., Matthee, M., Hattingh, M., & Weilbach, L. (2019). High school learners' continuance intention to use electronic textbooks: A usability study. *Education and Information Technologies*, 24(2), 1753–1776. <https://doi.org/10.1007/s10639-018-9850-z>
- Gil-Flores, J., Rodríguez-Santero, J., & Torres-Gordillo, J.-J. (2017). Factors that explain the use of ICT in secondary-education classrooms: The role of teacher characteristics and school infrastructure. *Computers in Human Behavior*, 68, 441–449. <https://doi.org/10.1016/j.chb.2016.11.057>
- Granić, A., & Ćukušić, M. (2011). Usability Testing and Expert Inspections Complemented by Educational Evaluation: A Case Study of an e-Learning Platform. *Educational Technology & Society*, 14(2), 107–123.
- Guàrdia, L., Maina, M., & Juliá, A. (2017). Digital Competence Assessment System: Supporting

teachers with the CRISS platform. *Central European Conference on Information and Intelligent Systems*, 77–82.

Guest, G., Namey, E., & McKenna, K. (2016). How Many Focus Groups Are Enough? Building an Evidence Base for Nonprobability Sample Sizes. *Field Methods*, 29(1), 3–22. <https://doi.org/10.1177/1525822X16639015>

Gupta, A., Yousaf, A., & Mishra, A. (2020). How pre-adoption expectancies shape post-adoption continuance intentions: An extended expectation-confirmation model. *International Journal of Information Management*, 52, 1–13. <https://doi.org/10.1016/j.ijinfomgt.2020.102094>

Hair, J. F., Black, W. C., Babin, B. J., & Anderson, R. E. (2010). *Multivariate Data Analysis* (7th ed.). NJ: Prentice-Hall.

Hair, J. F., Hult, G. T. M., Ringle, C. M., & Sarstedt, M. (2017). *A Primer on Partial Least Squares Structural Equation Modeling (PLS-SEM)* (2nd ed.). Thousand Oaks: Sage Publications.

Hair, J. F., Risher, J. J., Sarstedt, M., & Ringle, C. M. (2019). When to use and how to report the results of PLS-SEM. *European Business Review*, 31(1), 2–24. <https://doi.org/10.1108/EBR-11-2018-0203>

Halilovic, S., & Cicic, M. (2013). Antecedents of information systems user behaviour-extended expectation-confirmation model. *Behaviour and Information Technology*, 32(4), 359–370. <https://doi.org/10.1080/0144929X.2011.554575>

Hammond, N., Jørgensen, A., MacLean, A., Barnard, P., & Long, J. (1983). Design practice and interface usability. *Proceedings of the SIGCHI Conference on Human Factors in Computing Systems - CHI '83*, 40–44. <https://doi.org/10.1145/800045.801577>

Henseler, J., Ringle, C. M., & Sarstedt, M. (2015). A new criterion for assessing discriminant validity in variance-based structural equation modeling. *Journal of the Academy of Marketing Science*, 43(1), 115–135. <https://doi.org/10.1007/s11747-014-0403-8>

Henseler, J., Ringle, C. M., & Sinkovics, R. R. (2009). The use of partial least squares path modeling in international marketing. In R. R. Sinkovics & P. N. Ghauri (Eds.), *New Challenges to International Marketing (Advances in International Marketing, Vol. 20)* (pp. 277–319). Emerald Group Publishing Limited, Bingley. <https://doi.org/10.1108/S1474->

7979(2009)0000020014

- Hertzum, M. (2010). Images of usability. *International Journal of Human-Computer Interaction*, 26(6), 567–600. <https://doi.org/10.1080/10447311003781300>
- Hew, J. J., Lee, V. H., Ooi, K. B., & Lin, B. (2016). Mobile social commerce: The booster for brand loyalty? *Computers in Human Behavior*, 59, 142–154. <https://doi.org/10.1016/j.chb.2016.01.027>
- Hoehle, H., & Venkatesh, V. (2015). Mobile Application Usability: Conceptualization and Instrument Development. *MIS Quarterly*, 39(2), 435–472. <https://doi.org/10.25300/MISQ/2015/39.2.08>
- Hong, S. J., Thong, J. Y. L., & Tam, K. Y. (2006). Understanding continued information technology usage behavior: A comparison of three models in the context of mobile internet. *Decision Support Systems*, 42(3), 1819–1834. <https://doi.org/10.1016/j.dss.2006.03.009>
- Hopkins, N., Tate, M., Sylvester, A., & Johnstone, D. (2017). Motivations for 21st century school children to bring their own device to school. *Information Systems Frontiers*, 19(5), 1191–1203. <https://doi.org/10.1007/s10796-016-9644-z>
- Hornbæk, K., & Hertzum, M. (2017). Technology Acceptance and User Experience. *ACM Transactions on Computer-Human Interaction*, 24(5), 1–30. <https://doi.org/10.1145/3127358>
- Hossain, M. A., & Quaddus, M. (2012). Expectation–Confirmation Theory in Information System Research: A Review and Analysis. In Y. K. Dwivedi, M. R. Wade, & S. L. Schneberger (Eds.), *Information Systems Theory - Explaining and Predicting Our Digital Society, Vol. 1* (Vol. 28, pp. 441–469). Springer, New York, NY.
- Howie, S. J., & Blignaut, A. S. (2009). South Africa’s readiness to integrate ICT into mathematics and science pedagogy in secondary schools. *Education and Information Technologies*, 14(4), 345–363. <https://doi.org/10.1007/s10639-009-9105-0>
- Hozhabri, A., Raeesi, R., Salimianrizi, H., & Tayebiniya, J. (2014). Online Re-Purchase Intention: Testing Expectation Confirmation Model ECM on Online Shopping Context in Iran. *8th International Conference on E-Commerce with Focus on e-Trust*.

- Hsu, M. H., Chang, C. M., & Chuang, L. W. (2015). Understanding the determinants of online repeat purchase intention and moderating role of habit: The case of online group-buying in Taiwan. *International Journal of Information Management*, 35, 45–56. <https://doi.org/10.1016/j.ijinfomgt.2014.09.002>
- Hu, L., & Bentler, P. M. (1999). Cutoff criteria for fit indexes in covariance structure analysis: Conventional criteria versus new alternatives. *Structural Equation Modeling: A Multidisciplinary Journal*, 6(1), 1–55. <https://doi.org/10.1080/10705519909540118>
- Hurwitz, L. B., & Schmitt, K. L. (2020). Can children benefit from early internet exposure? Short- and long-term links between internet use, digital skill, and academic performance. *Computers & Education*, 146. <https://doi.org/10.1016/j.compedu.2019.103750>
- Hussain, A. E., & Khuddro, A. (2016). Quest for Truth - New Linguistic Research Methodologies. *British Journal of English Linguistics*, 4(1), 19–35.
- Ifinedo, P. (2018). Determinants of students' continuance intention to use blogs to learn: an empirical investigation. *Behaviour and Information Technology*, 37(4), 381–392. <https://doi.org/10.1080/0144929X.2018.1436594>
- Institute of Electrical and Electronics Engineers. (1990). *IEEE 610.12-1990 - IEEE Standard Glossary of Software Engineering Terminology*.
- ISO/IEC 25010. (2011). *Systems and software engineering - Systems and software Quality Requirements and Evaluation (SQuaRE) - System and software quality models*.
- ISO/IEC 9126-1. (2001). *Software Engineering - Product Quality - Part 1: Quality Model*.
- ISO/IEC 9126. (1991). *Software product evaluation - Quality characteristics and guidelines for their use*.
- ISO 9241-11. (1998). *Ergonomic requirements for office work with visual display terminals (VDTs) — Part 11 Guidance on usability*.
- ISO 9241-11. (2018). Ergonomics of human-system interaction - Part 11: Usability: Definitions and Concepts. In *Iso 9241-11:2018(E)*. <https://www.iso.org/obp/ui/#iso:std:iso:9241:-11:en>
- Jang, H., Ko, I., & Kim, J. (2013). The effect of group-buy social commerce and coupon on

- satisfaction and continuance intention: Focusing on the expectation confirmation model (ECM). *Proceedings of the Annual Hawaii International Conference on System Sciences*, 2938–2948. <https://doi.org/10.1109/HICSS.2013.516>
- Joo, Y. J., Kim, N., & Kim, N. H. (2016). Factors predicting online university students' use of a mobile learning management system (m-LMS). *Educational Technology Research and Development*, 64(4), 611–630. <https://doi.org/10.1007/s11423-016-9436-7>
- Joo, Y. J., Park, S., & Shin, E. K. (2017). Students' expectation, satisfaction, and continuance intention to use digital textbooks. *Computers in Human Behavior*, 69, 83–90. <https://doi.org/10.1016/j.chb.2016.12.025>
- Junjie, Z. (2017). Exploring the factors affecting learners' continuance intention of MOOCs for online collaborative learning: An extended ECM perspective. *Australasian Journal of Educational Technology*, 33(5), 123–135. <https://doi.org/10.14742/ajet.2914>
- Kang, C. R., Hung, M. C., Yang, S. T., Hsieh, T. C., & Tang, S. M. (2010). Factors affecting the continued intention of mobile shopping. *IEEM 2010 - IEEE International Conference on Industrial Engineering and Engineering Management*, 710–713. <https://doi.org/10.1109/IEEM.2010.5674612>
- Kang, Y. S., Hong, S., & Lee, H. (2009). Exploring continued online service usage behavior: The roles of self-image congruity and regret. *Computers in Human Behavior*, 25(1), 111–122. <https://doi.org/10.1016/j.chb.2008.07.009>
- Karahanna, E., Straub, D. W., & Chervany, N. L. (1999). Information Technology Adoption Across Time: A Cross-Sectional Comparison of Pre-Adoption and Post-Adoption Beliefs. *MIS Quarterly*, 23(2), 183. <https://doi.org/10.2307/249751>
- Kenny, D. A. (2018). *Moderator Variables: Introduction*. <http://davidakenny.net/cm/moderation.htm>
- Kim, B. (2010). An empirical investigation of mobile data service continuance: Incorporating the theory of planned behavior into the expectation-confirmation model. *Expert Systems with Applications*, 37(10), 7033–7039. <https://doi.org/10.1016/j.eswa.2010.03.015>
- Kim, D. J. (2012). An investigation of the effect of online consumer trust on expectation,

- satisfaction, and post-expectation. *Information Systems and E-Business Management*, 10(2), 219–240. <https://doi.org/10.1007/s10257-010-0136-2>
- Kim, H. C. (2015). Acceptability engineering: The study of user acceptance of innovative technologies. *Journal of Applied Research and Technology*, 13(2), 230–237. <https://doi.org/10.1016/j.jart.2015.06.001>
- Kim, K. H., Kim, K. J., Lee, D. H., & Kim, M. G. (2019). Identification of critical quality dimensions for continuance intention in mHealth services: Case study of onecare service. *International Journal of Information Management*, 46, 187–197. <https://doi.org/10.1016/j.ijinfomgt.2018.12.008>
- Kim, Y., & Crowston, K. (2011). Technology adoption and use theory review for studying scientists' continued use of cyber-infrastructure. *Proceedings of the ASIST Annual Meeting*, 48. <https://doi.org/10.1002/meet.2011.14504801197>
- Kitchenham, B. (2007). Guidelines for performing Systematic Literature Reviews in Software Engineering Version 2.3. In *EBSE Technical Report EBSE-2007-01* (pp. 1–57). <https://doi.org/10.1016/j.infsof.2008.09.009>
- Kivela, J., Inbakaran, R., & Reece, J. (1999). Consumer research in the restaurant environment, Part 1: A conceptual model of dining satisfaction and return patronage. *International Journal of Contemporary Hospitality Management*, 11(5), 205–222. <https://doi.org/10.1108/09596119910272739>
- Kluzer, S., & Pujol Priego, L. (2018). DigComp into Action - Get inspired, make it happen. In S. Carretero, Y. Punie, R. Vuorikari, M. Cabrera, & W. O'Keefe (Eds.), *European Commission. Publications Office of the European Union*. <https://doi.org/10.2760/112945>
- Kourouthanassis, P., Lekakos, G., & Gerakis, V. (2015). Should i stay or should i go? the moderating effect of self-image congruity and trust on social networking continued use. *Behaviour & Information Technology*, 34(2), 190–203. <https://doi.org/10.1080/0144929X.2014.948489>
- Kwon, O., & Wen, Y. (2010). An empirical study of the factors affecting social network service use. *Computers in Human Behavior*, 26(2), 254–263.

<https://doi.org/10.1016/j.chb.2009.04.011>

- Lancaster, G. (2005). *Research Methods in Management: A Concise Introduction to Research in Management and Business Consultancy*. Elsevier.
- Lazonder, A. W., Walraven, A., Gijlers, H., & Janssen, N. (2020). Longitudinal assessment of digital literacy in children: Findings from a large Dutch single-school study. *Computers and Education, 143*, 1–8. <https://doi.org/10.1016/j.compedu.2019.103681>
- Lee, E.-J., & Overby, J. (2004). Creating Value for Online Shoppers: Implications for Satisfaction and Loyalty. *Journal of Consumer Satisfaction, Dissatisfaction and Complaining Behavior, 17*, 54–67.
- Lewis, J. R. (1995). IBM computer usability satisfaction questionnaires: Psychometric evaluation and instructions for use. *International Journal of Human-Computer Interaction, 7*(1), 57–78.
- Liao, C., Chen, J. L., & Yen, D. C. (2007). Theory of planning behavior (TPB) and customer satisfaction in the continued use of e-service: An integrated model. *Computers in Human Behavior, 23*(6), 2804–2822. <https://doi.org/10.1016/j.chb.2006.05.006>
- Lim, J.-H., Chen, J.-C., & Wu, C. H. (2019). Effects of Consumption Value on Online Repurchase Intention: Mediation Effect of Green Information Visibility. In *Multidisciplinary Social Networks Research* (pp. 43–55). https://doi.org/10.1007/978-981-15-1758-7_4
- Limayem, M., & Cheung, C. M. K. (2008). Understanding information systems continuance: The case of Internet-based learning technologies. *Information and Management, 45*(4), 227–232. <https://doi.org/10.1016/j.im.2008.02.005>
- Limayem, M., Hirt, S. G., Cheung, C. M. K., & Hirt, S. G. (2007). How Habit Limits the Predictive Power of Intention: The Case of Information Systems Continuance. *MIS Quarterly, 31*(4), 705–737.
- LimeSurvey GmbH. (2003). *LimeSurvey: An Open Source survey tool*. LimeSurvey GmbH. <http://www.limesurvey.org>
- Lin, C. S., Wu, S., & Tsai, R. J. (2005). Integrating perceived playfulness into expectation-confirmation model for web portal context. *Information and Management, 42*(5), 683–693.

<https://doi.org/10.1016/j.im.2004.04.003>

- Lin, K. M. (2011). E-Learning continuance intention: Moderating effects of user e-learning experience. *Computers and Education*, 56(2), 515–526. <https://doi.org/10.1016/j.compedu.2010.09.017>
- Lin, W. S. (2012). Perceived fit and satisfaction on web learning performance: IS continuance intention and task-technology fit perspectives. *International Journal of Human Computer Studies*, 70(7), 498–507. <https://doi.org/10.1016/j.ijhcs.2012.01.006>
- Liu, W. (2014). A hybrid model for explaining older adults' continuance intention toward SNSs. *Proceedings - 2014 International Conference on Management of e-Commerce and e-Government, ICMecG 2014*, 138–142. <https://doi.org/10.1109/ICMeCG.2014.36>
- Lukacs, K. S., & Galluzzo, G. R. (2014). Beyond empty vessels and bridges: toward defining teachers as the agents of school change. *Teacher Development*, 18(1), 100–106. <https://doi.org/10.1080/13664530.2013.856338>
- Lund, B. A. M. (2001). Measuring usability with the USE Questionnaire. *Usability Interface*, 8(2), 3–6.
- Lynn, M. R. (1986). Determination and Quantification Of Content Validity. *Nursing Research*, 35(6), 382–386. <https://doi.org/10.1097/00006199-198611000-00017>
- Miller, R. B. (1971). Human ease of use criteria and their tradeoffs. *Technical Report: International Business Machines Corporation*.
- Moore, G. C., & Benbasat, I. (1991). Development of an instrument to measure the perceptions of adopting an information technology innovation. *Information Systems Research*, 2(3), 192–222. <https://doi.org/10.1287/isre.2.3.192>
- Mouakket, S., & Bettayeb, A. M. (2015). Investigating the factors influencing continuance usage intention of Learning management systems by university instructors. *International Journal of Web Information Systems*, 11(4), 491–509. <https://doi.org/http://dx.doi.org/10.1108/MRR-09-2015-0216>
- Mueller, R. O., & Hancock, G. R. (2001). Factor Analysis and Latent Structure, Confirmatory. In

- International Encyclopedia of the Social & Behavioral Sciences* (pp. 5239–5244). Elsevier.
<https://doi.org/10.1016/B0-08-043076-7/00426-5>
- Nabavi, A., Taghavi-Fard, M. T., Hanafizadeh, P., & Taghva, M. R. (2016). Information Technology Continuance Intention: A Systematic Literature Review. *International Journal of E-Business Research*, *12*(1), 58–95. <https://doi.org/10.4018/IJEER.2016010104>
- Najmul Islam, A. K. M., Mäntymäki, M., & Bhattacharjee, A. (2017). Towards a decomposed expectation confirmation model of it continuance: The role of usability. *Communications of the Association for Information Systems*, *40*(1), 502–523. <https://doi.org/10.17705/1CAIS.04023>
- Nascimento, B., Oliveira, T., & Tam, C. (2018). Wearable technology: What explains continuance intention in smartwatches? *Journal of Retailing and Consumer Services*, *43*, 157–169. <https://doi.org/10.1016/j.jretconser.2018.03.017>
- Newman, I., Lim, J., & Pineda, F. (2013). Content Validity Using a Mixed Methods Approach. *Journal of Mixed Methods Research*, *7*(3), 243–260. <https://doi.org/10.1177/1558689813476922>
- Nielsen, J. (1993). *Usability engineering*. Academic Press.
- Nielsen, J. (2012). *Usability 101: Introduction to Usability*. <https://www.nngroup.com/articles/usability-101-introduction-to-usability/>
- Nitzl, C., Roldan, J. L., & Cepeda, G. (2016). Mediation analysis in partial least squares path modeling. *Industrial Management & Data Systems*, *116*(9), 1849–1864. <https://doi.org/10.1108/IMDS-07-2015-0302>
- Norman, D. A. (1986). *User Centered System Design: New Perspectives on Human-computer Interaction* (D. A. Norman & S. W. Draper (eds.)). CRC Press.
- Norman, D. A. (1983). Design principles for human-computer interfaces. *Proceedings of the SIGCHI Conference on Human Factors in Computing Systems - CHI '83*, 1–10. <https://doi.org/10.1145/800045.801571>
- Nulty, D. D. (2008). The adequacy of response rates to online and paper surveys: what can be

- done? *Assessment & Evaluation in Higher Education*, 33(3), 301–314.
<https://doi.org/10.1080/02602930701293231>
- O'Brien, K. (1993). Improving Survey Questionnaires Through Focus Groups. In D. Morgan (Ed.), *Successful Focus Groups: Advancing the State of the Art* (pp. 105–117). SAGE Publications, Inc. <https://doi.org/10.4135/9781483349008>
- Oghuma, A. P., Libaque-Saenz, C. F., Wong, S. F., & Chang, Y. (2016). An expectation-confirmation model of continuance intention to use mobile instant messaging. *Telematics and Informatics*, 33(1), 34–47. <https://doi.org/10.1016/j.tele.2015.05.006>
- Oliver, R. L. (1980). A Cognitive Model of the Antecedents and Consequences of Satisfaction Decisions. *Journal of Marketing Research*, 17(4), 460. <https://doi.org/10.2307/3150499>
- Oliver, R. L. (1993). Cognitive, Affective, and Attribute Bases of the Satisfaction Response. *Journal of Consumer Research*, 20(3), 418. <https://doi.org/10.1086/209358>
- Oliver, R. L., & Burke, R. R. (1999). Expectation Processes in Satisfaction Formation: A Field Study. *Journal of Service Research*, 1(3), 196–214. <https://doi.org/10.1177/109467059913002>
- Ouellette, J. A., & Wood, W. (1998). Habit and Intention in Everyday Life: The Multiple Processes by Which Past Behavior Predicts Future Behavior. *Psychological Bulletin*, 124(1), 54–74. <https://doi.org/10.1037/0033-2909.124.1.54>
- Pang, L., & Jen, C. C. (2018). Inclusive dyslexia-friendly collaborative online learning environment: Malaysia case study. *Education and Information Technologies*, 23(3), 1023–1042. <https://doi.org/10.1007/s10639-017-9652-8>
- Patterson, P. G., Johnson, L. W., & Spreng, R. A. (1997). Modeling the determinants of customer satisfaction for business-to-business professional services. *Journal of the Academy of Marketing Science*, 25(1), 4–17. <https://doi.org/10.1007/BF02894505>
- Patterson, P. G., & Spreng, R. A. (1997). Modelling the relationship between perceived value, satisfaction and repurchase intentions in a business-to-business, services context: an empirical examination. *International Journal of Service Industry Management*, 8(5), 414–434. <https://doi.org/10.1108/09564239710189835>

- Pee, L. G., Jiang, J., & Klein, G. (2018). Signaling effect of website usability on repurchase intention. *International Journal of Information Management*, 39, 228–241. <https://doi.org/10.1016/j.ijinfomgt.2017.12.010>
- Perry, J. L., Nicholls, A. R., Clough, P. J., & Crust, L. (2015). Assessing model fit: Caveats and recommendations for confirmatory factor analysis and exploratory structural equation modeling. *Measurement in Physical Education and Exercise Science*, 19(1), 12–21. <https://doi.org/10.1080/1091367X.2014.952370>
- Pinsonneault, A., & Kraemer, K. (1993). Survey Research Methodology in Management Information Systems: An Assessment. *Journal of Management Information Systems*, 10(2), 75–105. <https://doi.org/10.1080/07421222.1993.11518001>
- Polit, D. F., & Beck, C. T. (2006). The content validity index: Are you sure you know what's being reported? critique and recommendations. *Research in Nursing & Health*, 29(5), 489–497. <https://doi.org/10.1002/nur.20147>
- Quesenbery, W. (2003). Dimensions of Usability: Defining the Conversation, Driving the Process. *Proceedings of the Usability Professional's Association (UPA) Conference on Ubiquitous Usability*.
- Quesenbery, W. (2001). What does usability mean: Looking beyond 'ease of use'. *Proceedings of the 18th Annual Conference Society for Technical Communications*, 432–436.
- R Core Team. (2017). *R: A Language and Environment for Statistical Computing*. R Foundation for Statistical Computing.
- Ramayah, T., Ahmad, N. H., & Hong, T. S. (2016). An Assessment of E-training Effectiveness in Multinational Companies in Malaysia. *Educational Technology & Society*, 15(2), 125–137.
- Rauf, I., Perälä, P., Huotari, J., & Porres, I. (2016). Perceived obstacles by novice developers adopting user interface APIs and tools. *Proceedings of IEEE Symposium on Visual Languages and Human-Centric Computing, VL/HCC*, 223–227. <https://doi.org/10.1109/VLHCC.2016.7739689>
- Recker, J. (2010). Continued use of process modeling grammars: The impact of individual difference factors. *European Journal of Information Systems*, 19(1), 76–92.

<https://doi.org/10.1057/ejis.2010.5>

Ringle, C. M., Wende, S., & Becker, J.-M. (2015). *SmartPLS 3*. SmartPLS GmbH. <http://www.smartpls.com>

Rizana, A. F., & Govindaraju, R. (2016). Enterprise Resource Planning system continuance usage intention at an individual level: An approach from value perspective. *Proceedings of 2016 International Conference on Data and Software Engineering, ICoDSE 2016*, 3–8. <https://doi.org/10.1109/ICODSE.2016.7936154>

Roca, J. C., Chiu, C. M., & Martínez, F. J. (2006). Understanding e-learning continuance intention: An extension of the Technology Acceptance Model. *International Journal of Human Computer Studies*, 64(8), 683–696. <https://doi.org/10.1016/j.ijhcs.2006.01.003>

Rogers, E. M. (1962). *Diffusion of innovations* (1st ed.). Free Press of Glencoe.

Rolf, E., Knutsson, O., & Ramberg, R. (2019). An analysis of digital competence as expressed in design patterns for technology use in teaching. *British Journal of Educational Technology*, 50(6), 3361–3375. <https://doi.org/10.1111/bjet.12739>

Ross, J. A., Hogaboam-Gray, A., & Hannay, L. (2001). Effects of teacher efficacy on computer skills and computer cognitions of canadian students in grades K-3. *Elementary School Journal*, 102(2), 141–156. <https://doi.org/10.1086/499697>

Rubio, D. M., Berg-Weger, M., Tebb, S. S., Lee, E. S., & Rauch, S. (2003). Objectifying content validity: Conducting a content validity study in social work research. *Social Work Research*, 27(2), 94–104. <https://doi.org/10.1093/swr/27.2.94>

Sackl, A., Schatz, R., & Raake, A. (2017). More than I ever wanted or just good enough? User expectations and subjective quality perception in the context of networked multimedia services. *Quality and User Experience*, 2(1), 3. <https://doi.org/10.1007/s41233-016-0004-z>

Sahi, G., & Madan, S. (2013). Developing a Website Usability Framework for B2C E-Commerce Success. *International Journal of Information Communication Technologies and Human Development*, 5(1), 1–19. <https://doi.org/10.4018/jicthd.2013010101>

Saunders, M., Lewis, P., & Thornhill, A. (2016). *Research Methods for Business Students* (7th ed.).

Pearson Education Limited.

- Scherer, R., Siddiq, F., & Teo, T. (2015). Becoming more specific: Measuring and modeling teachers' perceived usefulness of ICT in the context of teaching and learning. *Computers & Education*, 88, 202–214. <https://doi.org/10.1016/j.compedu.2015.05.005>
- Scherer, R., Siddiq, F., & Tondeur, J. (2019). The technology acceptance model (TAM): A meta-analytic structural equation modeling approach to explaining teachers' adoption of digital technology in education. *Computers and Education*, 128(0317), 13–35. <https://doi.org/10.1016/j.compedu.2018.09.009>
- Schoeffel, R. (2003). The concept of product usability. *ISO Bulletin*, March, 5–7.
- Segars, A. H., & Grover, V. (1998). Strategic information systems planning success: An investigation of the construct and its measurement. *MIS Quarterly: Management Information Systems*, 22(2), 139–162. <https://doi.org/10.2307/249393>
- Sekaran, U., & Bougie, R. (2016). *Research Methods for Business: A Skill-Building Approach* (7th ed.). John Wiley & Sons, Ltd.
- Selnes, F. (1998). Antecedents and consequences of trust and satisfaction in buyer-seller relationships. *European Journal of Marketing*, 32(3/4), 305–322. <https://doi.org/10.1108/03090569810204580>
- Shackel, B. (2009). Usability – Context, framework, definition, design and evaluation. *Interacting with Computers*, 21(5–6), 339–346. <https://doi.org/10.1016/j.intcom.2009.04.007>
- Shackel, Brian. (1981). The concept of usability. In J. Bennet, D. Case, J. Sandelin, & M. Smith (Eds.), *Proceedings of IBM software and information usability symposium* (pp. 1–30). Prentice-Hall.
- Shang, D., & Wu, W. (2017). Understanding mobile shopping consumers' continuance intention. *Industrial Management & Data Systems*, 117(1), 213–227. <https://doi.org/10.1108/IMDS-02-2016-0052>
- Sheppard, M., & Vibert, C. (2019). Re-examining the relationship between ease of use and usefulness for the net generation. *Education and Information Technologies*, 24(5), 3205–

3218. <https://doi.org/10.1007/s10639-019-09916-0>

Shneiderman, B. (2000). Universal usability. *Communications of the ACM*, 43(5), 84–91. <https://doi.org/10.1145/332833.332843>

Siddiq, F., Gochyyev, P., & Wilson, M. (2017). Learning in Digital Networks – ICT literacy: A novel assessment of students’ 21st century skills. *Computers and Education*, 109, 11–37. <https://doi.org/10.1016/j.compedu.2017.01.014>

Siddiq, F., Hatlevik, O. E., Olsen, R. V., Throndsen, I., & Scherer, R. (2016). Taking a future perspective by learning from the past - A systematic review of assessment instruments that aim to measure primary and secondary school students’ ICT literacy. *Educational Research Review*, 19, 58–84. <https://doi.org/10.1016/j.edurev.2016.05.002>

Song, B., & Wang, W. (2011). Instant messaging continuance: A media choice theory perspective. *Frontiers of Business Research in China*, 5(4), 537–558. <https://doi.org/10.1007/s11782-011-0144-1>

Sørrebø, Ø., & Eikebrokk, T. R. (2008). Explaining IS continuance in environments where usage is mandatory. *Computers in Human Behavior*, 24(5), 2357–2371. <https://doi.org/10.1016/j.chb.2008.02.011>

Sousa, P., Fonseca, H., Gaspar, P., & Gaspar, F. (2015). Usability of an internet-based platform (Next.Step) for adolescent weight management. *Jornal de Pediatria*, 91(1), 68–74. <https://doi.org/10.1016/j.jpmed.2014.05.010>

Spreng, R. A., MacKenzie, S. B., & Olshavsky, R. W. (1996). A Reexamination of the Determinants of Consumer Satisfaction. *Journal of Marketing*, 60(3), 15–32. <https://doi.org/10.1177/002224299606000302>

Stewart, T. (2000). Ergonomics user interface standards: Are they more trouble than they are worth? *Ergonomics*, 43(7), 1030–1044. <https://doi.org/10.1080/001401300409206>

Stone, R. W., & Baker-Eveleth, L. (2013). Students’ expectation, confirmation, and continuance intention to use electronic textbooks. *Computers in Human Behavior*, 29(3), 984–990. <https://doi.org/10.1016/j.chb.2012.12.007>

- Stopar, K., & Bartol, T. (2019). Digital competences, computer skills and information literacy in secondary education: mapping and visualization of trends and concepts. *Scientometrics*, *118*(2), 479–498. <https://doi.org/10.1007/s11192-018-2990-5>
- Straub, D., & Gefen, D. (2004). Validation Guidelines for IS Positivist Research. *Communications of the Association for Information Systems*, *13*(24), 380–427. <https://doi.org/10.17705/1CAIS.01324>
- Sun, H., & Zhang, P. (2006). The role of moderating factors in user technology acceptance. *International Journal of Human Computer Studies*, *64*(2), 53–78. <https://doi.org/10.1016/j.ijhcs.2005.04.013>
- Susanto, A., Chang, Y., & Ha, Y. (2016). Determinants of continuance intention to use the smartphone banking services An extension to the expectation-confirmation model. *Industrial Management & Data Systems*, *116*(3), 508–525. <https://doi.org/dx.doi.org/10.1108/IMDS-07-2015-0266>
- Susanto, A., Chang, Y., Zo, H., & Park, M. C. (2012). The role of trust and security in Smartphone banking continuance. *Conference Proceedings - IEEE International Conference on Systems, Man and Cybernetics*, 2133–2138. <https://doi.org/10.1109/ICSMC.2012.6378055>
- Susarla, Barua, & Whinston. (2003). Understanding the Service Component of Application Service Provision: An Empirical Analysis of Satisfaction with ASP Services. *MIS Quarterly*, *27*(1), 91. <https://doi.org/10.2307/30036520>
- Swan, J. E., & Trawick, I. F. (1981). Disconfirmation of expectations and satisfaction with a retail service. *Journal of Retailing*, *57*(3), 49–67.
- Tan, M., Prasanna, R., Hudson-Doyle, E., Stock, K., Johnston, D., & Leonard, G. (2018). Usability Factors Affecting the Continuance Intention of Disaster Apps. *ISCRAM Asia Pacific 2018 Proceedings - 1st International Conference on Information Systems for Crisis Response and Management Asia Pacific.*, 326–338.
- Terzis, V., Moridis, C. N., & Economides, A. A. (2013). Continuance acceptance of computer based assessment through the integration of user's expectations and perceptions. *Computers and Education*, *62*, 50–61. <https://doi.org/10.1016/j.compedu.2012.10.018>

- Thong, J. Y. L., Hong, S. J., & Tam, K. Y. (2006). The effects of post-adoption beliefs on the expectation-confirmation model for information technology continuance. *International Journal of Human Computer Studies*, 64(9), 799–810. <https://doi.org/10.1016/j.ijhcs.2006.05.001>
- Tondeur, J., Valcke, M., & Van Braak, J. (2008). A multidimensional approach to determinants of computer use in primary education: Teacher and school characteristics. *Journal of Computer Assisted Learning*, 24(6), 494–506. <https://doi.org/10.1111/j.1365-2729.2008.00285.x>
- Tsai, H. T., Chien, J. L., & Tsai, M. T. (2014). The influences of system usability and user satisfaction on continued Internet banking services usage intention: Empirical evidence from Taiwan. *Electronic Commerce Research*, 14(2), 137–169. <https://doi.org/10.1007/s10660-014-9136-5>
- Tse, D. K., & Wilton, P. C. (1988). Models of Consumer Satisfaction Formation: An Extension. *Journal of Marketing Research*, 25(2), 204. <https://doi.org/10.2307/3172652>
- Tudor, S. L. (2018). The Open Resources and Their Influences on the Formation of Specific Competencies for the Teaching Profession. *10th International Conference on Electronics, Computers and Artificial Intelligence, ECAI 2018*, 1–4. <https://doi.org/10.1109/ECAI.2018.8679010>
- Tulinayo, F. P., Ssentume, P., & Najjuma, R. (2018). Digital technologies in resource constrained higher institutions of learning: a study on students' acceptance and usability. *International Journal of Educational Technology in Higher Education*, 15(1). <https://doi.org/10.1186/s41239-018-0117-y>
- University of New South Wales (UNSW). (n.d.). *International Competitions and Assessments for Schools (ICAS)*. ICAS Computer Skills Assessment Framework. <https://www.unswglobal.unsw.edu.au/educational-assessments/>
- Urbach, N., & Ahlemann, F. (2010). Structural Equation Modeling in Information Systems Research Using Partial Least Squares. *Journal of Information Technology Theory and Application*, 11(2), 5–40.
- Varela, C., Rebollar, C., García, O., Bravo, E., & Bilbao, J. (2019). Skills in computational thinking

- of engineering students of the first school year. *Heliyon*, 5(11), 1–9. <https://doi.org/10.1016/j.heliyon.2019.e02820>
- Venkatesh, Morris, Davis, & Davis. (2003). User Acceptance of Information Technology: Toward a Unified View. *MIS Quarterly*, 27(3), 425. <https://doi.org/10.2307/30036540>
- Venkatesh, V., & Davis, F. D. (2000). A Theoretical Extension of the Technology Acceptance Model: Four Longitudinal Field Studies. *Management Science*, 46(2), 186–204. <https://doi.org/10.1287/mnsc.46.2.186.11926>
- Venkatesh, V., & Goyal, S. (2010). Expectation Disconfirmation and Technology Adoption: Polynomial Modeling and Response Surface Analysis. *MIS Quarterly*, 34(2), 281–303.
- Venter, M., & Swart, A. J. (2018). An integrated model for the continuous use intention of Microsoft Office simulation software. *Global Engineering Education Conference (EDUCON), 2018 IEEE*, 320–329.
- Viswanathan, M., Sudman, S., & Johnson, M. (2004). Maximum versus meaningful discrimination in scale response: Implications for validity of measurement of consumer perceptions about products. *Journal of Business Research*, 57(2), 108–124. [https://doi.org/10.1016/S0148-2963\(01\)00296-X](https://doi.org/10.1016/S0148-2963(01)00296-X)
- Wang, Lew, S.-L., Lau, S.-H., & Leow, M.-C. (2019). Usability factors predicting continuance of intention to use cloud e-learning application. *Heliyon*, 5(6). <https://doi.org/10.1016/j.heliyon.2019.e01788>
- Wang, R.-B., & Du, C.-T. (2014). Mobile Social Network Sites as innovative pedagogical tools: factors and mechanism affecting students' continuance intention on use. *Journal of Computers in Education*, 1(4), 353–370. <https://doi.org/10.1007/s40692-014-0015-9>
- Webster, J., & Watson, R. T. (2002). Analyzing the past to prepare for the future: Writing a literature review. *MIS Quarterly*, 26(2), 13–23.
- Weinerth, K., Koenig, V., Brunner, M., & Martin, R. (2014). Concept maps: A useful and usable tool for computer-based knowledge assessment? A literature review with a focus on usability. *Computers and Education*, 78, 201–209. <https://doi.org/10.1016/j.compedu.2014.06.002>

- Wild, D., Grove, A., Eremenco, S., McElroy, S., Verjee-Lorenz, A., & Erikson, P. (2005). Principles of Good Practice for the Translation and Cultural Adaptation Process for Patient-Reported Outcomes (PRO) Measures: Report of the ISPOR Task Force for Translation and Cultural Adaptation. *Value in Health*, 8(2), 94–104.
- Wohlin, C. (2014). Guidelines for snowballing in systematic literature studies and a replication in software engineering. *Proceedings of the 18th International Conference on Evaluation and Assessment in Software Engineering - EASE '14*, 1–10. <https://doi.org/10.1145/2601248.2601268>
- Wong, E. M. L., & Li, S. C. (2008). Framing ICT implementation in a context of educational change: a multilevel analysis. *School Effectiveness and School Improvement*, 19(1), 99–120. <https://doi.org/10.1080/09243450801896809>
- Wright, K. (2002). Social support within an on-line cancer community: an assessment of emotional support, perceptions of advantages and disadvantages, and motives for using the community from a communication perspective. *Journal of Applied Communication Research*, 30(3), 195–209. <https://doi.org/10.1080/00909880216586>
- Wu, I. L., & Huang, C. Y. (2015). Analysing complaint intentions in online shopping: The antecedents of justice and technology use and the mediator of customer satisfaction. *Behaviour and Information Technology*, 34(1), 69–80. <https://doi.org/10.1080/0144929X.2013.866163>
- Wu, J., & Du, H. (2012). Toward a better understanding of behavioral intention and system usage constructs. *European Journal of Information Systems*, 21(6), 680–698. <https://doi.org/10.1057/ejis.2012.15>
- Yassierli, Y., Vinsensius, V., & Mohamed, M. S. S. (2018). The Importance of Usability Aspect in M-Commerce Application for Satisfaction and Continuance Intention. *Makara Journal of Technology*, 22(3), 149. <https://doi.org/10.7454/mst.v22i3.3655>
- Zabotkina, V., Korovkina, M., & Sudakova, O. (2019). Competence-based approach to a module design for the Master Degree Programme in Translation: Challenge of Tuning Russia Tempus Project. *Tuning Journal for Higher Education*, 7(1). [https://doi.org/10.18543/tjhe-7\(1\)-](https://doi.org/10.18543/tjhe-7(1)-)

2019pp67-92

Zhang, H., Lu, Y., Gupta, S., & Gao, P. (2015). Understanding group-buying websites continuance: An extension of expectation confirmation model. *Internet Research*, 25(5), 767–793. <https://doi.org/http://dx.doi.org/10.1108/MRR-09-2015-0216>

Zhou, T. (2011). An empirical examination of users' post-adoption behaviour of mobile service. *Behaviour & Information Technology*, 30(2), 241–250. <https://doi.org/10.1007/s10660-013-9106-3>

Zikmund, W. G. (2003). *Business Research Methods* (7th ed.). Thomson South Western.

APPENDICES

Appendix A: Initial Set of Items

Construct	No	Items	Adapted from - Reference(s)	Initial construct
Perceived effectiveness	1	Whenever I made an error using the CRISS platform, I could recover easily and quickly.	(Lewis, 1995; Lund, 2001)	Information Quality; Ease of use
	2	Using the CRISS platform helps overall in my teaching.	(Baker-Eveleth & Stone, 2015)	Effectiveness
	3	There are no distraction messages within the CRISS platform.	(Lewis, 1995; Oghuma et al., 2016)	Information Quality; User interface
	4	The CRISS platform is well organized.	(Najmul Islam et al., 2017)	Perceived usability
	5	The CRISS platform has a simple layout for its content.	(Najmul Islam et al., 2017)	Perceived usability
	6	The CRISS platform fits well with how I teach.	(Baker-Eveleth & Stone, 2015)	Effectiveness
	7	The CRISS platform capabilities meet my requirements.	(Finstad, 2010)	Effectiveness
	8	The CRISS platform allows me to accomplish my tasks.	(Finstad, 2010)	Effectiveness
	9	It is easy to complete tasks in the CRISS platform.	(Lewis, 1995)	Interface quality
	10	I would not need to supplement the CRISS platform with an additional one.	(Finstad, 2010)	Effectiveness
	11	I think I would need another digital platform with more features for my tasks.	(Finstad, 2010)	Effectiveness
	12	I can perform the task within the CRISS platform without any errors.	(Finstad, 2010)	Effectiveness
Perceived efficiency	1	The pages within the CRISS platform load quickly.	(Baker-Eveleth & Stone, 2015)	Efficiency
	2	The CRISS platform saves me time.	(Finstad, 2010)	Efficiency
	3	The CRISS platform displays the information at a rate that is fast enough.	(Baker-Eveleth & Stone, 2015)	Efficiency
	4	It provides few clicks to locate the information in the CRISS platform.	(Najmul Islam et al., 2017)	Perceived usability
	5	It is easy to navigate through the CRISS platform.	(Najmul Islam et al., 2017)	Perceived usability

	6	I tend to make a lot of mistakes with the CRISS platform.	(Finstad, 2010)	Efficiency
	7	I have to spend a lot of time correcting things with the CRISS platform.	(Finstad, 2010)	Efficiency
IS continuance intention	1	My intentions are to continue using the CRISS platform rather than using an alternative platform.	(Baker-Eveleth & Stone, 2015; Bhattacharjee, 2001; Najmul Islam et al., 2017)	Continuance intention
	2	If I could, I would like to discontinue my use of the CRISS platform.	(Bhattacharjee, 2001)	IS continuance intention
	3	I plan to continue using the CRISS platform after this class.	(Baker-Eveleth & Stone, 2015; Daghan & Akkoyunlu, 2016; Oghuma et al., 2016)	Continuance intention
	4	I intend to continue using the CRISS platform to teach new digital competence.	(Baker-Eveleth & Stone, 2015; Bhattacharjee, 2001; Oghuma et al., 2016)	Continuance intention
	5	I intend to continue using the CRISS platform rather than discontinue.	(Bhattacharjee, 2001)	IS continuance intention
Satisfaction	1	Using the CRISS platform is a frustrating experience.	(Baker-Eveleth & Stone, 2015; Finstad, 2010)	Satisfaction
	2	The CRISS platform is fun to use.	(Lund, 2001; Oghuma et al., 2016)	Satisfaction; Perceived enjoyment
	3	I would recommend the CRISS platform to another teacher.	(Lund, 2001)	Satisfaction
	4	I would prefer to use something other than the CRISS platform.	(Finstad, 2010)	Satisfaction
	5	I feel comfortable using the CRISS platform.	(Lewis, 1995)	System usefulness
	6	I am pleased with how the CRISS platform facilitates my teaching.	(Baker-Eveleth & Stone, 2015; Bhattacharjee, 2001)	Satisfaction
	7	I am satisfied with the CRISS platform.	(Bhattacharjee, 2001; Lewis, 1995)	Satisfaction; System usefulness
	8	I am extremely satisfied with my use of the CRISS platform.	(Baker-Eveleth & Stone, 2015)	Satisfaction
	9	I am extremely pleased with my use of the CRISS platform.	(Najmul Islam et al., 2017)	Satisfaction
	10	I am extremely delighted with my use of the CRISS platform.	(Baker-Eveleth & Stone, 2015)	Satisfaction
	11	I am extremely contented with my use of the CRISS platform.	(Najmul Islam et al., 2017)	Satisfaction

	12	Given a choice, I would choose the CRISS platform over others.	(Finstad, 2010)	Satisfaction
Perceived usefulness	1	Using the CRISS platform makes it easier to communicate with others.	(Najmul Islam et al., 2017)	Perceived usefulness
	2	Using the CRISS platform is of benefit to me.	(Najmul Islam et al., 2017)	Perceived usefulness
	3	Using the CRISS platform increases my productivity in class.	(Bhattacharjee, 2001; Oghuma et al., 2016)	Perceived usefulness
	4	Using the CRISS platform improves my performance in teaching.	(Alraimi et al., 2015; Bhattacharjee, 2001)	Perceived usefulness
	5	Using the CRISS platform enhances my effectiveness in teaching.	(Alraimi et al., 2015; Bhattacharjee, 2001)	Perceived usefulness
	6	Using the CRISS platform enables me to accomplish document sharing more quickly.	(Najmul Islam et al., 2017)	Perceived usefulness
	7	The CRISS platform is useful for my teaching.	(Alraimi et al., 2015; Bhattacharjee, 2001)	Perceived usefulness
Confirmation	1	The service level provided by the CRISS platform is better than what I expected.	(Daghan & Akkoyunlu, 2016; Oghuma et al., 2016)	Confirmation
	2	My experience with using the CRISS platform was better than what I expected.	(Bhattacharjee, 2001; Daghan & Akkoyunlu, 2016)	Confirmation
	3	Most of my expectations from using the CRISS platform are confirmed.	(Bhattacharjee, 2001)	Confirmation

Appendix B: Judgements of Experts (CVR)

Scoring constructs	Item No.	<i>Experts</i>											<i>Not necessary (1)</i>	<i>Important. but not essential (2)</i>	<i>Essential (3)</i>	Important (rating 2 or 3)	CVR
		1	2	3	4	5	6	7	8	9	10	11					
Perceived effectiveness	1	1	1	1	2	2	2	1	1	1	2	2	6	5	0	5	-0.09
	2	3	2	3	2	3	2	3	1	2	3	2	1	5	5	10	0.82
	3	1	1	1	2	1	2	2	1	1	1	2	7	4	0	4	-0.27
	4	2	3	2	2	2	2	3	2	1	3	3	1	6	4	10	0.82
	5	1	2	1	1	2	1	1	1	1	1	3	8	2	1	3	-0.45
	6	3	3	3	2	3	3	2	1	2	3	2	1	4	6	10	0.82
	7	3	3	3	1	2	3	3	2	2	2	3	1	4	6	10	0.82
	8	3	2	3	3	3	2	2	3	2	2	1	1	5	5	10	0.82
	9	3	2	3	2	3	3	3	3	2	3	1	1	3	7	10	0.82
	10	1	1	2	2	1	1	2	2	2	1	1	6	5	0	5	-0.09
	11	1	1	2	1	2	1	1	1	2	2	1	7	4	0	4	-0.27
	*12	1	2	3	2	3	3	3	2	2	2	2	1	6	4	10	0.82
Perceived efficiency	1	2	3	3	3	3	2	2	2	2	2	1	1	6	4	10	0.82
	2	2	2	3	3	3	3	3	2	2	2	1	1	5	5	10	0.82
	3	1	1	2	2	2	2	1	1	1	2	2	5	6	0	6	0.09
	4	1	3	2	2	3	3	3	3	2	2	3	1	4	6	10	0.82
	5	3	2	2	3	2	3	2	2	1	3	3	1	5	5	10	0.82
	6	1	1	1	1	2	2	2	2	2	2	1	5	6	0	6	0.09
	7	1	1	1	1	1	1	1	2	2	2	1	8	3	0	3	-0.45
IS continuance intention	1	2	3	2	3	3	3	2	3	2	2	3	0	5	6	11	1.00
	2	2	2	1	2	2	2	2	1	1	1	1	5	6	0	6	0.09
	3	3	3	3	3	2	3	3	2	2	3	3	0	3	8	11	1.00
	4	2	2	3	3	2	3	3	3	1	3	3	1	3	7	10	0.82

	5	2	2	3	3	2	3	3	3	3	2	3	0	4	7	11	1.00
Satisfaction	1	1	1	1	2	2	2	2	1	1	2	2	5	6	0	6	0.09
	2	3	3	3	3	3	3	3	1	3	2	3	1	1	9	10	0.82
	3	3	3	3	3	3	3	3	1	3	2	3	1	1	9	10	0.82
	4	3	1	3	3	2	3	3	1	1	2	3	3	2	6	8	0.45
	5	3	3	3	3	2	3	3	3	3	3	3	0	1	10	11	1.00
	6	3	1	3	3	2	2	3	3	2	2	3	1	4	6	10	0.82
	7	2	3	2	3	2	2	2	3	3	3	3	0	5	6	11	1.00
	8	3	2	2	3	2	1	3	1	2	2	3	2	5	4	9	0.64
	9	3	1	2	3	2	1	3	2	3	3	3	2	3	6	9	0.64
	10	1	1	2	2	2	1	1	1	1	1	1	8	3	0	3	-0.45
	11	1	1	2	1	2	2	2	1	2	1	2	5	6	0	6	0.09
	12	1	1	2	1	2	2	2	1	1	1	1	7	4	0	4	-0.27
Perceived usefulness	1	3	2	3	3	3	3	3	2	3	2	1	1	3	7	10	0.82
	2	2	3	3	3	3	3	3	3	3	2	3	0	2	9	11	1.00
	3	3	2	3	3	2	3	3	2	3	3	3	0	3	8	11	1.00
	4	3	3	3	2	3	3	3	3	3	1	3	1	1	9	10	0.82
	5	3	3	3	2	2	3	3	3	3	2	2	0	4	7	11	1.00
	6	1	1	3	2	2	3	3	3	3	1	2	3	3	5	8	0.45
	7	1	2	3	2	2	3	2	2	2	2	2	1	8	2	10	0.82
Confirmation	1	1	1	1	1	1	1	3	1	1	1	2	9	1	1	2	-0.64
	2	3	2	2	3	3	3	3	3	3	3	3	0	2	9	11	1.00
	3	3	3	3	3	3	3	2	1	2	2	3	1	3	7	10	0.82

Note: Each item of a construct is rated on a 3-point rating scale ('1 – Not necessary', '2 – Important, but not essential', and '3 – Essential'). CVR (Content validity ratio) value ranges from -1 to +1. The suggested cut-off value is at least .818 (min. 80%) and the minimum number of experts agreed an item is important for the inclusion in the instrument should be at least 9 out of 11 (Ayre & Scally, 2013).

Appendix C: Survey in Croatian

1. dio: Uvod u anketu

Poštovani nastavnici,

kao sudionici CRISS projekta, vaši učenici i vi koristili ste platformu CRISS koja je rezultat projekta H2020 "*Demonstration of a scalable and cost-effective cloud-based digital learning infrastructure through the Certification of digital competences in primary and secondary schools – CRISS*".

Ovim upitnikom želimo saznati više o vašim iskustvima vezanim za korištenje platforme CRISS iz različitih aspekata. Vaši odgovori omogućit će autorima CRISS platforme daljnji razvoj i poboljšanja. Nadalje, vaše će povratne informacije omogućiti našim istraživačima analizu i opis primjera dobrih praksi u korištenju takvih sustava te tako omogućiti budući razvoj sličnih sustava u različitim domenama.

Upitnik je anonimn i odgovori će se tumačiti na razini grupe s ciljem postizanja ciljeva CRISS projekta. **Upitnik se sastoji od šest dijelova te je za njegovo popunjavanje potrebno oko 15 minuta**. Napominjemo da uvod svakog dijela sadrži kratki opis cilja kako bi vam omogućio razumijevanje konteksta navedenih tvrdnji upitnika. Molimo Vas da pažljivo pročitate ove opise te da u slučaju bilo kakvih dodatnih pitanja i komentara pošaljete upit na: aleksandra.sobodic@foi.hr.

Zahvaljujemo za vaše uloženo vrijeme i trud,

S poštovanjem,
CRISS istraživački tim

Postoji 42 pitanja u ovom upitniku.

Informacija o privatnosti

Ovaj upitnik je anonimn.

Zapisi Vaših odgovora ne sadrže informacije preko kojih bi Vas se moglo identificirati, osim ukoliko se to izričito ne traži u anketi. Ukoliko koristite identifikacijske tokene za pristup ovom upitniku, budite sigurni da token neće biti spremljeni zajedno sa Vašim odgovorima. Tokeni se spremaju u zasebnu bazu podataka i biti će izmijenjeni nakon što završite (ili ne završite) ispunjavanje upitnika. Ne postoji način za povezivanje tokena s danim odgovorima.

2. dio: Demografska pitanja

Šifra	Pitanje	Odgovori
D1	Spol:	<ul style="list-style-type: none"> <input type="radio"/> Muški <input type="radio"/> Ženski
D2	Starost:	<ul style="list-style-type: none"> <input type="radio"/> Ispod 25 <input type="radio"/> 25-29 <input type="radio"/> 30-39 <input type="radio"/> 40-49 <input type="radio"/> 50-59 <input type="radio"/> Iznad 60
D3	Koja je vaša razina obrazovanja?	<ul style="list-style-type: none"> <input type="radio"/> Gimnazijsko srednjoškolsko obrazovanje; Četverogodišnje i petogodišnje strukovno srednjoškolsko obrazovanje <input type="radio"/> Strukovno specijalističko usavršavanje i osposobljavanje; Programi za majstore uz najmanje dvije godine vrednovanog radnog iskustva <input type="radio"/> Sveučilišni preddiplomski studiji; Stručni preddiplomski studiji <input type="radio"/> Sveučilišni diplomski studij; Specijalistički diplomski stručni studij; Poslijediplomski specijalistički studij <input type="radio"/> Poslijediplomski znanstveni magistarski studij; Poslijediplomski sveučilišni (doktorski) studij; Obrana doktorske disertacije izvan studija
D4	Škola u kojoj ste trenutno zaposleni:	<p>[PADAJUĆA LISTA]</p> <ul style="list-style-type: none"> <input type="radio"/> Nije na popisu <input type="radio"/> Popis škola
D5	Ukoliko škola nije na popisu, upišite naziv škole u kojoj radite (ako nije na popisu):	[SLOBODNI UNOS]
D6	Razina škole u kojoj radite:	<ul style="list-style-type: none"> <input type="radio"/> Osnovna škola <input type="radio"/> Srednja škola
D7	Koliko imate godina nastavničkog iskustva?	<ul style="list-style-type: none"> <input type="radio"/> manje od 1 godine <input type="radio"/> 1-2 godine <input type="radio"/> 3-5 godine <input type="radio"/> 6-10 godina <input type="radio"/> 11-15 godina <input type="radio"/> 16-20 godina <input type="radio"/> Više od 20 godina
D8	S koliko vaših učenika provodite aktivnosti na CRISS platformi? (približno)	[SLOBODNI UNOS]
D9	Kojem ukupnom broju učenika trenutno predajete? (približno)	[SLOBODNI UNOS]
D10	Koja je vaša razina vještina rada na računalu?	<ul style="list-style-type: none"> <input type="radio"/> Osnovne vještine rada na računalu (npr. tipkanje, rad mišem) <input type="radio"/> Osnovne vještine rada na računalu i upotrebe aplikacija <input type="radio"/> Samostalan rad na računalu i pri upotrebi aplikacija <input type="radio"/> Napredan rad na računalu i pri upotrebi aplikacija <input type="radio"/> Stručan rad na računalu i pri upotrebi aplikacija te vještina programiranja
		<ul style="list-style-type: none"> <input type="radio"/> Osnovne vještine rada na računalu (npr. tipkanje, rad mišem) <i>Opis: Sposobnost identificiranja računalnih komponenti (miš, tipkovnica, pisač, zaslon, itd.), Razumijevanje aplikacijskih izbornika, stvaranje, spremanje i brisanje dokumenata, izvođenje osnovnog ispisa itd.</i> <input type="radio"/> Osnovne vještine rada na računalu i upotrebe aplikacija

<p><i>Opis: Sposobnost stvaranja, uređivanja i oblikovanja tekstualnih dokumenata, računskih tablica i prezentacija, slanje, prosljeđivanje i kopiranje (CC) e-pošte, za obavljanje online pretraživanja, ocjenjivanje rezultata, pretraživanje informacija o preuzimanju itd.</i></p> <ul style="list-style-type: none"> ○ Samostalan rad na računalu i pri upotrebi aplikacija <i>Opis: Sposobnost razumijevanja operacijskih sustava, umetanja linkova, tablica, videozapisa itd. u dokumente, poznavanje rada s različitim pogledima u računskim tablicama i bazama podataka, prepoznavanje datoteka različitih formata, sposobnost identifikacije veličine datoteke i ispravnog korištenja privitka prilikom slanja e-pošte, znanje izvođenja složenog sortiranja, korištenje filtera itd.</i> ○ Napredan rad na računalu i pri upotrebi aplikacija <i>Opis: Sposobnost razumijevanja elemenata računala i računalnih programa, stvaranje distribucijskih lista, prijenos datoteka putem mrežnih resursa, stvaranje složenih grafova, korištenje složenih operacija kao što su makro naredbe, korištenje naprednih formula u računskim tablicama, za osnovno razumijevanje programiranja, itd.</i> ○ Stručan rad na računalu i pri upotrebi aplikacija te vještina programiranja <i>Opis: Sposobnost izvođenja naprednih operacija s bazama podataka, poznavanje programskih jezika i korištenje specifičnih računalnih vještina.</i> 		
D11	Koliko dugo koristite CRISS platformu?	<ul style="list-style-type: none"> ○ Manje od 1 mjeseca ○ 1-2 mjeseca ○ 2-3 mjeseca ○ Više od 3 mjeseca
D12	Koliko puta tjedno pristupate CRISS platformi?	<ul style="list-style-type: none"> ○ Nijednom ○ 1 - 3 puta tjedno ○ 4 - 6 puta tjedno ○ 7 - 9 puta tjedno ○ 10 - 12 puta tjedno ○ Više od 12 puta tjedno
D13	Koliko sati tjedno provodite na CRISS platformi?	<ul style="list-style-type: none"> ○ Manje od 1 sata ○ 1-2 sata ○ 3-4 sata ○ Više od 4 sata

3. dio: Anketni upitnik

ZA NASTAVNIKE pojam aktivnost odnosi se na planiranje (zadavanje rokova, dodavanje sadržaja s obzirom na scenarij učenja, i sl.), ocjenjivanje priče / dokaza učenika, praćenje analitike učenja putem CRISS platforme i slično.

Korištena ljestvica (#1):

1	2	3	4	5
Uopće se ne slažem	Uglavnom se ne slažem	Niti se slažem, niti se ne slažem	Uglavnom se slažem	U potpunosti se slažem

Percipirana djelotvornost

DIO 1: CRISS platforma je napravljena na način da omogući nastavnicima da na ispravan, cjelovit i prikladan način izvrše određene aktivnosti te ostvare postavljene ciljeve. Zato nam je veoma važno vaše mišljenje o tome možete li pronaći odgovarajuću opciju za izradu novog plana, postavljanje rokova ili praćenje analitike učenja svojih učenika ili jesu li vam informacije prikazane na prikladan način što se tiče veličine i boje slova i sl.

Šifra	Čestice	Ljestvica
PFE1	CRISS platforma mi pomaže u poučavanju.	1 2 3 4 5
PFE2	CRISS platforma je dobro organizirana.	1 2 3 4 5
PFE3	CRISS platforma odgovara mom načinu poučavanja.	1 2 3 4 5
PFE4	CRISS platforma mi omogućuje da obavim neku aktivnost na svoj način.	1 2 3 4 5
PFE5	Informacije prikazane na CRISS platformi su potpune.	1 2 3 4 5
PFE6	Na CRISS platformi mogu bez većih problema pronaći opciju kako bi izvršio/la neku aktivnost (npr. za izradu novog plana, dodavanje sadržaja u plan, dodjeljivanje roka za rješavanje zadatka, provjeru analitike učenja i sl.).	1 2 3 4 5
Percipirana učinkovitost		
DIO 2: CRISS platforma je napravljena na način da omogući nastavnicima da brzo i jednostavno izvrše određene aktivnosti. Zato nam je veoma važno vaše mišljenje o tome smatrate li da ste brzi u izvršavanju određenih aktivnosti na CRISS platformi ili je li vam lako pronaći opciju za prikaz napretka svojih učenika ili za izradu novog plana, i sl.		
Šifra	Čestice	Ljestvica
PFI1	CRISS platforma je brza (npr. stranice se brzo učitavaju).	1 2 3 4 5
PFI2	CRISS platforma mi omogućuje da brže napravim neku aktivnost.	1 2 3 4 5
PFI3	Jednostavno je napraviti neku aktivnost na CRISS platformi.	1 2 3 4 5
PFI4	Jednostavno je komunicirati putem CRISS platforme.	1 2 3 4 5
PFI5	Na CRISS platformi brzo pronalazim informacije koje trebam.	1 2 3 4 5
PFI6	Kretanje kroz CRISS platformu je jednostavno.	1 2 3 4 5
PFI7	Tekst prikazan na CRISS platformi je lako čitljiv (veličina, tip i boja slova).	1 2 3 4 5
Namjera ponovnog korištenja platforme		
DIO 3: Glavna ideja CRISS-a je stvoriti platformu koja će unaprijediti svakodnevno poučavanje, ocjenjivanje i praćenje napretka vaših učenika. Stoga nam je važno primiti povratnu informaciju o tome biste li nastavili koristiti CRISS platformu i sljedeće školske godine.		
Šifra	Čestice	Ljestvica
CI1	Želio/željela bih nastaviti koristiti CRISS platformu uz tradicionalne načine poučavanja (npr. zadaci na papiru, e-Dnevnik i sl.).	1 2 3 4 5
CI2	Namjeravam nastaviti učestalo koristiti CRISS platformu.	1 2 3 4 5
CI3	Radije bih nastavio/la koristiti CRISS platformu nego je prestao/la koristiti.	1 2 3 4 5
Zadovoljstvo		
DIO 4: Autorima CRISS platforme važno je znati jesu li nastavnici zadovoljni s mogućnostima i svojim radom na platformi. Molimo vas povratnu informaciju o tome koliko ste zadovoljni s mogućnostima i sadržajem dostupnima na CRISS platformi.		
Šifra	Čestice	Ljestvica
SAT1	Preporučio/la bih CRISS platformu drugim nastavnicima/ama.	1 2 3 4 5
SAT2	Sviđa mi se koristiti CRISS platformu.	1 2 3 4 5
SAT3	Zadovoljan/na sam kako sam koristio/la CRISS platformu.	1 2 3 4 5

SAT4	Zadovoljan/na sam načinom na koji mi CRISS platforma olakšava poučavanje.	1 2 3 4 5
Percipirana korisnost		
DIO 5: Cilj autora CRISS platforme je da pomognu nastavnicima ostvariti bolje rezultate u poučavanju. Molimo vas povratnu informaciju o očekivanim dobitima korištenja CRISS platforme.		
Šifra	Čestice	Ljestvica
PU1	CRISS platforma mi pomaže da brže poučavam.	1 2 3 4 5
PU2	CRISS platforma mi pomaže da ostvarim bolje rezultate u poučavanju.	1 2 3 4 5
PU3	CRISS platforma je korisna za poučavanje.	1 2 3 4 5
PU4	CRISS platforma ima više prednosti nego nedostataka.	1 2 3 4 5

Korištena ljestvica (#2):

1	2	3	4	5
Daleko ispod mojih očekivanja	Donekle ispod mojih očekivanja	U skladu s mojim očekivanjima	Donekle iznad mojih očekivanja	Daleko iznad mojih očekivanja

Potvrda		
DIO 6: Autorima CRISS-a važno je znati ispunjava li ili pak nadilazi platforma očekivanja nastavnika. Stoga nam je važno primiti vašu povratnu informaciju jesu li izgled i korištenje CRISS platforme u skladu ili iznad vaših očekivanja.		
Šifra	Čestice	Ljestvica
CON1	CRISS platforma je zadovoljila sva moja očekivanja.	1 2 3 4 5
CON2	Izgled CRISS platforme je zadovoljio moja očekivanja.	1 2 3 4 5
CON3	CRISS platformu je lagano koristiti kao što sam i očekivao/la.	1 2 3 4 5
CON4	Kroz CRISS platformu sam poučavao/la brzo kao što sam i očekivao/la.	1 2 3 4 5
CON5	CRISS platforma mi je pomogla u praćenju napretka mojih učenika kao što sam i očekivao/la.	1 2 3 4 5

Appendix D: Survey in English

1. part: Survey introduction

Dear teacher,

As participants of the CRISS project your students and you have been using the CRISS platform resulting from the H2020 project 'Demonstration of a scalable and cost-effective cloud-based digital learning infrastructure through the Certification of digital competences in primary and secondary schools – CRISS'. With this questionnaire we would like to find out more about your experience related to the use of the CRISS platform from different aspects. Your answers will enable CRISS platform creators its further development and improvements. Furthermore, your feedback will enable our researchers to analyse and define best practice examples in using such systems and therefore foster future development of similar systems in different domains.

This is an anonymous questionnaire, and the answers will be interpreted at a group level with the aim to accomplish CRISS project objectives. The questionnaire consists of six main sections and it takes around 15 minutes for its completion. Please note that the header of each section includes the description of its aim in order to enable you to understand the context of the associated questions. Please read carefully these descriptions and in case of any additional comments or questions please contact aleksandra.sobodic@foi.hr.

Thank you for the invested time and effort,

Respectfully,

CRISS Research Team

There are 42 questions in this survey.

A note on privacy

This survey is anonymous.

The record of your survey responses does not contain any identifying information about you, unless a specific survey question explicitly asked for it. If you used an identifying token to access this survey, please rest assured that this token will not be stored together with your responses. It is managed in a separate database and will only be updated to indicate whether you did (or did not) complete this survey. There is no way of matching identification tokens with survey responses.

2. part: Demographic questions

Code	Question	Answers
D1	What is your gender?	<input type="radio"/> Man <input type="radio"/> Women
D2	How old are you?	<input type="radio"/> Under 25 <input type="radio"/> 25-29 <input type="radio"/> 30-39 <input type="radio"/> 40-49 <input type="radio"/> 50-59 <input type="radio"/> Over 60
D3	What is the highest level of education you have completed? <i>*Each country should adapt the level of education to its own standards.</i>	<input type="radio"/> High school diploma <input type="radio"/> Associate's degree <input type="radio"/> Bachelor's Degree <input type="radio"/> Master's Degree <input type="radio"/> Doctorate Degree
D4	What is the name of school you are currently working at?	[DROPDOWN MENU] <input type="radio"/> Not listed <input type="radio"/> Provided list of schools
D5	Type the name of your school (<i>if not listed above</i>):	[FREE ENTRY]
D6	Type of school:	<input type="radio"/> Primary school <input type="radio"/> Secondary school
D7	How many years of teaching experience do you have?	<input type="radio"/> Less than 1 year <input type="radio"/> 1-2 years <input type="radio"/> 3-5 years <input type="radio"/> 6-10 years <input type="radio"/> 11-15 years <input type="radio"/> 16-20 years <input type="radio"/> Over 20 years
D8	How many students do you administer/guide in the CRISS platform? (approximately)	[FREE ENTRY]
D9	How many students do you currently teach? (approximately)	[FREE ENTRY]
D10	What is your level of computer skill?	<input type="radio"/> Fundamental Skills (Typing, Mouse) <input type="radio"/> Basic Computing and Applications <input type="radio"/> Intermediate Computing and Applications <input type="radio"/> Advanced Computing and Applications <input type="radio"/> Proficient Computing, Applications, and Programming
<input type="radio"/> Fundamental Skills (Typing, Mouse) <i>Description: Ability to identify computer components (mouse, keyboard, printer, screen, etc.), to understand application menus, to create, save and delete documents, to perform basic printing, etc.</i>		
<input type="radio"/> Basic Computing and Applications <i>Description: Ability to create, edit and format text document, spreadsheet and presentation, to send, forward and carbon copy (CC) emails, to conduct online search, evaluate search results, to download information etc.</i>		
<input type="radio"/> Intermediate Computing and Applications <i>Description: Ability to understand operating systems, to insert hyperlinks, tables, videos, etc. into documents, to be able to work with different views in spreadsheets and databases, to recognize different file formats, identify file size and to properly use attachments when sending an email, to conduct complex sorting, use of filters, etc.</i>		

<ul style="list-style-type: none"> ○ Advanced Computing and Applications <i>Description: Ability to understand computer hardware and software elements, to create distribution lists, to transfer files via online resources, to create complex graphs, to use complex operations such as macro commands, to use advanced formulas in spreadsheets, to have basic understanding of programming, etc.</i> ○ Proficient Computing, Applications, and Programming <i>Description: Ability to perform advanced operations with databases, to know programming languages and to use specific computer skills.</i> 		
D11	How long do you use the CRISS platform?	<ul style="list-style-type: none"> ○ Less than 1 month ○ 1-2 months ○ 2-3 months ○ More than 3 months
D12	How many times a week do you access the CRISS platform?	<ul style="list-style-type: none"> ○ Never ○ 1 - 3 times a week ○ 4 - 6 times a week ○ 7 - 9 times a week ○ 10 - 12 times a week ○ More than 12 times a week
D13	How many hours a week do you spend on the CRISS platform?	<ul style="list-style-type: none"> ○ Less than 1 hour a week ○ 1 - 2 hours a week ○ 3 - 4 hours a week ○ More than 4 hours a week

3. part: Survey questionnaire

FOR TEACHERS the term ACTIVITY refers to planning (setting deadlines, adding content based on learning scenarios, etc.), evaluating student's story/evidence, tracking learning analytics through the CRISS platform, and similar.

Used scale (#1):

1	2	3	4	5
Strongly disagree	Somewhat disagree	Neither agree nor disagree	Somewhat agree	Strongly agree

Perceived effectiveness		
PART 1: CRISS platform is designed to enable teachers to perform certain activities in an accurate, complete and appropriate way and to achieve the set goals. Therefore, it is very important to receive your opinion about whether you can find the appropriate option to create a new plan, set deadlines or check students' learning analytics or are the information presented in an appropriate way regarding the size and colour of the letters, and similar.		
Code	Items	Scale
PFE1	CRISS platform helps me in teaching.	1 2 3 4 5
PFE2	CRISS platform is well organized.	1 2 3 4 5
PFE3	CRISS platform suits my way of teaching.	1 2 3 4 5

PFE4	CRISS platform allows me to do a certain activity in the way I want it.	1 2 3 4 5
PFE5	The information provided on the CRISS platform is complete.	1 2 3 4 5
PFE6	I can find an option on the CRISS platform without much trouble (e.g. for making a new plan, adding content to planning, setting the due date for task solving, checking the learning analytics, and similar).	1 2 3 4 5
Perceived efficiency		
PART 2: CRISS platform is designed to enable teachers to perform certain activities in a quick and easy way. Therefore, it is very important to receive your opinion about how fast do you think you are in performing certain activities with the support of the CRISS platform, or whether it is easy for you to find an option to check students' progress or make a new plan, and similar.		
Code	Items	Scale
PFI1	CRISS platform is fast (e.g. pages load quickly).	1 2 3 4 5
PFI2	CRISS platform allows me to quickly perform a certain activity.	1 2 3 4 5
PFI3	It is easy to complete a certain activity in the CRISS platform.	1 2 3 4 5
PFI4	It is easy to communicate through the CRISS platform.	1 2 3 4 5
PFI5	I can quickly find the information I need in the CRISS platform.	1 2 3 4 5
PFI6	It is easy to navigate through the CRISS platform.	1 2 3 4 5
PFI7	It is easy to read the text (font size, type and colour) on the CRISS platform.	1 2 3 4 5
IS continuance intention		
PART 3: The main idea behind CRISS is to create a platform which will improve different aspects of teacher's everyday teaching, assessment and tracking students' progress. Therefore, it is very important for us to receive feedback on whether you would continue using the CRISS platform for the next school year.		
Code	Items	Scale
CI1	I intend to continue using the <i>CRISS platform</i> together with traditional ways of teaching (e.g. pencil-paper tasks, *web application for checking grades, absences or notes written by teachers available for both students and their parents) <i>*This description can be replaced by any other web application used in your school.</i>	1 2 3 4 5
CI2	I intend to continue using the <i>CRISS platform</i> frequently.	1 2 3 4 5
CI3	I would like to continue using the <i>CRISS platform</i> rather than discontinue its use.	1 2 3 4 5
Satisfaction		
PART 4: It is very important for CRISS creators to know whether the teachers are satisfied with the possibilities and their work on the platform. Please let us know your level of satisfaction with the features and content available on the CRISS platform.		
Code	Items	Scale
SAT1	I would recommend the CRISS platform to other teachers.	1 2 3 4 5
SAT2	I like using the CRISS platform.	1 2 3 4 5
SAT3	I am satisfied with my use of the CRISS platform.	1 2 3 4 5
SAT4	I am pleased with how the CRISS platform facilitates my teaching.	1 2 3 4 5
Perceived usefulness		

PART 5: The aim of CRISS creators is to help teachers to achieve better results in teaching. Please provide the feedback on the expected benefits of using the platform.

Code	Items	Scale
PU1	CRISS platform helps me to teach faster.	1 2 3 4 5
PU2	CRISS platform helps me to achieve better results in teaching.	1 2 3 4 5
PU3	CRISS platform is useful for teaching.	1 2 3 4 5
PU4	CRISS platform has more advantages than disadvantages.	1 2 3 4 5

Used scale (#2):

1	2	3	4	5
Far below my expectations	Somewhat below my expectations	In line with my expectations	Somewhat over my expectations	Far beyond my expectations

Confirmation

PART 6: It is very important for CRISS creators to know whether the platform meets or exceeds teachers' expectations. Therefore, it is very important to receive feedback on whether the layout and use of the CRISS platform are in line or above your expectations.

Code	Items	Scale
CON1	CRISS platform has met all my expectations.	1 2 3 4 5
CON2	The layout of the CRISS platform has met my expectations.	1 2 3 4 5
CON3	CRISS platform is easy to use as I expected.	1 2 3 4 5
CON4	Through CRISS platform I taught as fast as I expected.	1 2 3 4 5
CON5	CRISS platform helped me to track the progress of my students as I expected.	1 2 3 4 5

CURRICULUM VITAE

Aleksandra Sobodić was born in Pula in 1990. In 2014 she obtained her master's degree from the Faculty of Organization and Informatics, University of Zagreb. In the academic year 2012/2013 she received the Rector's Award at the University of Zagreb for her student scientific paper.

In 2014 she started working as an expert assistant at the Centre for International Projects of the Faculty of Organization and Informatics, after which in 2015 she moved to the position of teaching assistant at the Department of Computing and Technology. In the same year, she enrolled in the postgraduate doctoral study in Information Science at the Faculty of Organization and Informatics.

She has published several scientific papers and presented at domestic and international scientific conferences. She is a member of the Laboratory for Advanced Technologies in Education, and actively participates in the projects of the Faculty.

List of published papers:

1. Balaban, Igor; Sobodić, Aleksandra. Prioritizing factors for the successful deployment of digital competence certification systems in schools. // *IEEE Technology & Engineering Management Conference - Europe (TEMSCON-EUR) Virtual Conference: IEEE*, 2021. pp. 1-5 doi:10.1109/temscon-eur52034.2021.9488572 (other, international peer review, full paper, scholarly)
2. Balaban, Igor; Sobodić, Aleksandra. Exploring Relationship Between User Satisfaction and Impacts of Digital Competence Certification System in Schools. // *Human Systems Engineering and Design III. IHSED 2020. Advances in Intelligent Systems and Computing, vol 1269* / Karwowski, Waldemar ; Ahram, Tareq ; Etinger, Darko ; Tanković, Nikola ; Taiar, Redha (ed.). Cham: Springer International Publishing, 2021. pp. 344-349 doi:10.1007/978-3-030-58282-1_54 (lecture, international peer review, full paper, scholarly)
3. Sobodić, Aleksandra; Balaban, Igor; Filipović, Danijel. A Case Study of Students' Usage of a Platform for Digital Competence Certification in Schools. // *31st International Scientific Conference* / Strahonja, Vjeran ; Steingartner, William ; Kirinić, Valentina (ed.).

- Varaždin: Faculty of Organization and Informatics, University of Zagreb, 2020. pp. 1-6. (<https://www.bib.irb.hr/1114048>) (other, international peer review, full paper, scholarly)
4. Sobodić, Aleksandra; Balaban, Igor. Usability Testing of a Digital Competence Assessment and Certification System. // *Lecture Notes in Computer Science / Zaphiris, P. ; Ioannou, A. (ed.)*. Cham: Springer International Publishing, 2020. pp. 194-206 doi:10.1007/978-3-030-50513-4_15 (lecture, international peer review, full paper, scholarly)
 5. Sobodić, Aleksandra; Balaban, Igor. Interplay Between Usability and Information System Continuance: An Extended Model. // *Advances in Intelligent Systems and Computing / Ahram, T. ; Falcão, C. (ed.)*. Cham: Springer International Publishing, 2020. pp. 399-411 doi:10.1007/978-3-030-19135-1_39 (lecture, international peer review, full paper, scholarly)
 6. Balaban, Igor; Ravet, Serge; Sobodić, Aleksandra. EPortfolio Maturity Framework. // *The Challenges of the Digital Transformation in Education. Advances in Intelligent Systems and Computing. / Auer, Michael E. ; Tsiatsos, Thrasyvoulos (ed.)*. Cham: Springer International Publishing, 2019. pp. 473-484 doi:10.1007/978-3-030-11935-5_45 (lecture, international peer review, full paper, scholarly)
 7. Balaban, Igor; Sobodić, Aleksandra. The development of an instrument for assessing the deployment success of a cloud based system for the acquisition of digital competences. // *Proceedings of EDULEARN18 Conference / Gómez Chova, L. ; López Martínez, A. ; Torres, Candel (ed.)*. Palma de Mallorca: IATED Academy, 2018. pp. 2644-2653 doi:10.21125/edulearn.2018.0706 (other, international peer review, full paper, scholarly)
 8. Balaban, Igor; Stančin, Kristian; Sobodić, Aleksandra. Analysis of correlations between indicators influencing successful deployment of ePortfolios. // *Proceedings of the 41st MIPRO International Convention on Computers in Education Rijeka: Croatian Society for Information and Communication Technology, Electronics and Microelectronics*, 2018. pp. 864-869 (lecture, international peer review, full paper, scholarly)
 9. Sobodić, Aleksandra; Balaban, Igor; Kermek, Dragutin. Usability Metrics for Gamified E-learning Course: A Multilevel Approach. // *International Journal of Emerging Technologies in Learning (iJET)*, 13 (2018), 05; 41-55 doi:10.3991/ijet.v13i05.8425 (international peer review, article, scholarly)

10. Sobodić, Aleksandra; Balaban, Igor; Tomašević, Mia. The Impact of Cultural Dimensions on Student's Use of E-Learning System. // *Proceedings of 28th Central European Conference on Information and Intelligent Systems (CECIIS 2017)* / Strahonja, Vjeran ; Kirinić, Valentina (ur.) (ed.). Varaždin: Faculty of Organization and Informatics, University of Zagreb, 2017. pp. 53-60. (<https://www.bib.irb.hr/897455>) (lecture, international peer review, full paper, scholarly)
11. Spahić, Amir; Grd, Petra; Sobodić, Aleksandra; Škvorc, Lana; Grabar, Darko; Knowledge Management 2.0 for SMEs., Warsava, *Poljska: Management Observatory Foundation*, 2015 (handbook). (<https://www.bib.irb.hr/740473>)
12. Horvat, Jelena; Klačmer Čalopa, Marina; Sobodić, Aleksandra. Analysis of human resources in science and technology in ICT companies-case of Croatia. // *Journal of information and organizational sciences*, 38 (2014), 2; 97-107. (<https://www.bib.irb.hr/1125877>) (international peer review, article, other)
13. Horvat, Jelena; Klačmer Čalopa, Marina; Sobodić, Aleksandra. Social responsibility of companies - green jobs. // *Book of Proceedings, 6th International Scientific Conference on Economic and Social fevelopment and 3rd Eastern European ESD Conference: Business Continuity* / Jadranka Bendekovic, Marina Klacmer Calopa and Davor Filipovic (ed.). Varazdin: Varazdin Development and Entrepreneurship Agency, Varazdin, Croatia, 2014. pp. 565-574 (lecture, international peer review, full paper, scholarly)