

# Model predictive control in hydro turbine power control

---

**Beus, Mateo**

**Doctoral thesis / Disertacija**

**2021**

*Degree Grantor / Ustanova koja je dodijelila akademski / stručni stupanj:* **University of Zagreb, Faculty of Electrical Engineering and Computing / Sveučilište u Zagrebu, Fakultet elektrotehnike i računarstva**

*Permanent link / Trajna poveznica:* <https://urn.nsk.hr/urn:nbn:hr:168:953422>

*Rights / Prava:* [In copyright / Zaštićeno autorskim pravom.](#)

*Download date / Datum preuzimanja:* **2024-07-31**



*Repository / Repozitorij:*

[FER Repository - University of Zagreb Faculty of Electrical Engineering and Computing repository](#)





University of Zagreb

FACULTY OF ELECTRICAL ENGINEERING AND COMPUTING

Mateo Beus

**MODEL PREDICTIVE CONTROL IN HYDRO  
TURBINE POWER CONTROL**

DOCTORAL THESIS

Zagreb, 2021.



University of Zagreb

FACULTY OF ELECTRICAL ENGINEERING AND COMPUTING

Mateo Beus

# **MODEL PREDICTIVE CONTROL IN HYDRO TURBINE POWER CONTROL**

DOCTORAL THESIS

Supervisor: Professor Hrvoje Pandžić, PhD

Zagreb, 2021.



Sveučilište u Zagrebu  
FAKULTET ELEKTROTEHNIKE I RAČUNARSTVA

Mateo Beus

# **MODELSKO PREDIKTIVNO UPRAVLJANJE U REGULACIJI SNAGE HIDROTURBINE**

DOKTORSKI RAD

Mentor: prof. dr. sc. Hrvoje Pandžić

Zagreb, 2021.

The doctoral thesis was completed at the University of Zagreb Faculty of Electrical Engineering and Computing, Department of Energy and Power Systems, Zagreb, Croatia

Supervisor: Professor Hrvoje Pandžić, PhD

The thesis has: 84 pages

Thesis number: \_\_\_\_\_

## About the Supervisor

Hrvoje Pandžić was born in 1984 in Zagreb, Croatia. He received his Masters and PhD degrees from the University of Zagreb Faculty of Electrical Engineering and Computing (UNIZG-FER) in 2007 and 2011, respectively. After being a postdoctoral researcher at the University of Washington, Seattle, 2012-2014, he became an Assistant Professor at UNIZG-FER in 2014. Currently, he is an Associate Professor at UNIZG-FER and the Head of the Department of Energy and Power Systems.

He has coordinated many European and national projects focused on electricity markets, energy storage, batteries, electric vehicles, microgrids and power system flexibility. He published over 50 papers in journals categorized as Q1/Q2 according to JCR.

He received numerous awards, including the Award Science by the Government of the Republic of Croatia, 2018; Award for the highest scientific and artistic achievements in Croatia by the Croatian Academy of Science and Arts for 2018; Award Vera Johanides by the Croatian Academy of Engineering, 2015. He has been an Associate Member of the Croatian Academy of Science and Arts since 2020.

He is an Editor of IEEE Transactions on Power Systems and Energies journals.

He is an IEEE Senior Member, as well as a member of INFORMS and CIGRE.

Besides research achievements, he has led 10 technical studies for commercial partners.

---

## O mentoru

Hrvoje Pandžić rođen je 1984. godine u Zagrebu. Završio je diplomski studij 2007. i doktorski studij 2011. godine na Sveučilištu u Zagrebu Fakultetu elektrotehnike i računarstva (UNIZG-FER). Nakon pozicije poslijedoktoranda na Sveučilištu Washington u Seattleu 2012-2014., postaje docent na UNIZG-FER 2014. godine. Trenutno je izvanredni profesor i predstojnik Zavoda za visoki napon i energetiku.

Vodio je mnoge europske i nacionalne projekte usmjerene na energetska tržišta, spremnike energije, baterije, električna vozila, mikromreže i fleksibilnost elektroenergetskog sustava. Objavio je preko 50 znanstvenih radova u znanstvenim časopisima kvalificiranima kao Q1 ili Q2 prema JCR.

Dobitnik je mnogih nagrada, uključujući nagradu Znanost Republike Hrvatske za 2018. godinu, Nagradu za najviše znanstvene i umjetničke uspjehe Hrvatske akademije znanosti i umjetnosti za 2018. godinu te nagradu Vera Johanides Hrvatske akademije tehničkih znanosti za 2015. godinu. Član-suradnik je Hrvatske akademije znanosti i umjetnosti od 2020. godine.

Član je uređivačkog odbora časopisa IEEE Transactions on Power Systems i Energies.

Član je profesionalnih udruženja IEEE (Senior Member), INFORMS i CIGRE.

Osim znanstvenih uspjeha, vodio je 10 tehničkih projekata za komercijalne naručitelje.

## **Preface**

Throughout the writing of this dissertation I have received a great deal of support and assistance.

I would first like to thank my family, especially my wife Rafaela and our daughter Doris, for their continuous support. Furthermore, I would like to thanks for the support of my parents Ana and Vlatko, as well as support from my mother-in-law Zorka.

Many thanks to my supervisor prof. Hrvoje Pandžić for his mentoring throughout my doctoral research as well as to my colleagues from the Department of Energy and Power Systems at FER for technical and nontechnical discussions which ultimately help me to frame this dissertation.



## Abstract

Hydro turbine governor applications mainly rely on classical Proportional-Integral-Derivative (PID) controllers. The main weakness of classical controllers is their design based on a linear plant model and a fixed parameter scheme. This means that a classical controller can perform optimally only at the operating point chosen during the controller design. However, hydro power plants are highly nonlinear systems, thus alternative control approaches based on adaptive parameters are needed. This research investigates the possibility of applying model predictive controller (MPC) as the load/frequency controller in hydro turbine governors. In the first part of the research the MPC algorithm is validated on the nonlinear simulation model of a laboratory hydro power plant, while in the second part of the research the MPC controller is implemented on a programmable logic controller that is used as a hydro turbine governor in the hydro power plant available in the Smart Grid laboratory at the University of Zagreb Faculty of Electrical Engineering and Computing. Furthermore, MPC controller behavior and practical implementation potential are validated for different operating conditions.

Scientific contribution of the thesis consists of the following:

- Model predictive control algorithm for a load/frequency controller of a hydro turbine governor
- Methodology for real-time implementation of model predictive control algorithm using programmable logic controller, as well as an evaluation of MPC algorithm's practical implementation potential for a load/frequency controller of a hydro turbine governor

**Keywords:** load frequency control, Pelton turbine, programmable logic controller, model predictive control, hydro turbine governor

# Prošireni sažetak

## Modelsko prediktivno upravljanje u regulaciji snage hidroturbine

U modernim elektroenergetskim mrežama hidroelektrane se koriste kao okosnica za pružanje usluga primarne regulacije frekvencije zbog njihove brzine odziva. Naime, hidroelektrane imaju mogućnost promjene snage u cijelom području rada kroz 10 do 15 sekundi. U tom smislu turbinski regulatori su jedna od glavnih komponenti svake hidroelektrane koji osiguravaju njihovu veliku brzinu odziva. Općenito govoreći svaki turbinski regulator sastoji se regulatora snage i regulatora brzine vrtnje. Regulator snage se koristi za upravljanje izlaznom snagom hidroelektrane dok elektrana radi u paralelnom pogonu s krutom mrežom. Regulator brzine vrtnje se koristi prilikom sinkronizacije hidroelektrane na mrežu kao i prilikom otočnog pogona hidroelektrane za regulaciju brzine vrtnje turbine, odnosno regulaciju frekvencije. Klasični proporcionalno-integracijsko-derivacijski (PID) regulatori najčešća su vrsta regulatora koji se koriste u svrhu turbinske regulacije svih vrsta vodnih turbina. Glavni razlog za to su njihova robusnost i jednostavnost implementacije. Međutim, veliki nedostatak klasičnih regulatora s fiksnim parametrima leži u činjenici da se oni projektiraju na temelju linearnih modela sustava, dok se simulacije obično obavljaju na nelinearnim modelima.

Budući da su hidroelektrane izrazito nelinearni sustavi, klasični regulatori s fiksnim parametrima mogu raditi optimalno samo u radnoj točki za koju su projektirani, dok odmakom od te radne točke dolazi do pogoršavanja upravljačkih performansi. U znanstvenoj i stručnoj literaturi postoji veliki broj metoda za unapređenje upravljačkih karakteristika hidroelektrana preko cijelog pogonskog područja prilagođavajući parametre regulatora trenutnoj radnoj točki. Najčešće korišteni napredni upravljački algoritmi dostupni u literaturi su neizrazita logika (engl. fuzzy logic), metaheuristički algoritam PSO (eng. Particle Swarm Optimization – PSO) te algoritmi prediktivnog upravljanja. Međutim, pregled dostupne literature ukazao je na nedostatak trenutno dostupnih algoritama za regulaciju snage hidroelektrane. Naime, niti jedan od dostupnih algoritama nije implementiran na komercijalno dostupnom turbinskom regulatoru čime bi se provela i praktična validacija upravljačkog algoritma. U tom smislu, glavni cilj ovog istraživanja je da ispuni prazninu, odnosno da napravi poveznicu između teorijskog razvoja prediktivnog regulatora snage hidroelektrane i njegove praktične implementacije i validacije na komercijalno dostupnom turbinskom regulatoru. U doktorskom radu je predstavljen algoritam modelskog prediktivnog regulatora (engl. Model Predictive Control – MPC) snage čiji parametri linearnog predikcijskog modela se ažuriraju u ovisnosti o trenutnoj radnoj točki hidroturbine. Nadalje, predloženi algoritam je implementiran i validiran na komercijalno dostupnom turbinskom regulatoru.

Razvoj upravljačkog algoritma proveden je koristeći Matlab razvojnu okolinu te TIA Portal V14 za implementaciju upravljačkog algoritma na programibilni logički kontroler (engl.

---

Programmable Logic Controller – PLC) turbinskog regulatora. Za praktičnu validaciju upravljačkog rješenja korišten je PLC tvrtke SIEMENS koji ima oznaku ET200 SP s CPU modulom 1512SP–1 PN. Dodatno, koristeći alat WinCC flexible proširen je i ekran (engl. human machine interface – HMI) koji se koristi za parametriranje regulatora. Na ovaj način moguće je mijenjati ograničenja koja se koriste u sklopu optimizacijskog algoritma implementiranog prediktivnog regulatora. Sva tehnička ograničenja hidroelektrane zasnovana su na parametrima laboratorijske hidroelektrane. Dio parametara laboratorijske hidroelektrane javno je dostupan, dok je dio parametara identificiran izravnim mjerenjima na hidroelektrani koja su opisana u doktorskom radu.

Glavne komponente laboratorijske hidroelektrane korištene za praktičnu validaciju predloženog algoritma regulacije snage hidroturbine su: tlačni cjevovod, Pelton turbina te sinkroni generator. Ovdje treba istaknuti da se tlak na izlazu iz tlačnog cjevovoda regulira koristeći vodenu pumpu koja ima mogućnost regulacije tlaka između 5.5 bara i 6.5 bara. Na ovaj način se može simulirati neto pad od 55 m do 65 m. Nadalje, na laboratorijskoj hidroelektrani su instalirani senzori za mjerenje svih veličina potrebnih za realizaciju predloženog algoritma upravljanja. U tom smislu na kraju tlačnog cjevovoda instaliran je mjerni pretvornik za mjerenje tlaka na izlazu iz tlačnog cjevovoda, enkoder za mjerenje brzine vrtnje turbine, senzori položaja hidrauličkih cilindara te na stezaljama sinkronog generatora mjerni pretvornik za mjerenje energetskih veličina (djelatna snaga, prividna snaga, jalova snaga, frekvencija mreže i harmoničko izobličenje napona i struja po fazama). Budući da se radi o laboratorijskoj hidroelektrani na kućištu sinkronog generatora instaliran je i senzor za mjerenje vibracija generatora te su u svakom od faznih namota sinkronog generatora instalirane temperaturne sonde za mjerenje temperature svakog namota. Nadalje, budući da je hidroelektrana sastavni dio laboratorijske mikromreže realiziran je i daljinski nadzor i upravljanje hidroelektranom koristeći laboratorijski centralni nadzorni i upravljački sustav (engl. Supervisory Control and Data Acquisition System – SCADA). Koristeći laboratorijski SCADA sustav moguće je nadgledati glavna energetska mjerenja hidroelektrane, brzinu vrtnje turbine te tlak na izlazu iz tlačnog cjevovoda. Isto tako moguće je i slati naloge za pokretanje/zaustavljanje hidroelektrane kao i zahtjeve za promjenom postavnih vrijednosti djelatne i jalove snage elektrane.

Istraživanje je provedeno u dva glavna koraka. U prvom koraku razvijen je algoritam prediktivnog regulatora snage hidroelektrane čiji se parametri linearnog predikcijskog modela ažuriraju ovisno o trenutnoj radnoj točki hidroelektrane koja je određena tlakom na izlazu iz tlačnog cjevovoda, položajem igle koja regulira protok vode kroz turbinu te brzinom vrtnje turbine. Parametri linearnog predikcijskog modela laboratorijske hidroelektrane su određeni za različite radne točke u ovisnosti o tlaku na izlazu iz tlačnog cjevovoda i položaju igle kojom se regulira protok vode, dok je brzina vrtnje turbine bila nepromjenjena u svim radnim točkama budući da je hidroelektrana bila sinkronizirana na mrežu. Koristeći parametre linernog modela

---

hidroelektrane koji su određeni za različite radne točke formirana je tablica za pretraživanje iz koje prediktivni regulator povlači koeficijente predikcijskog modela u ovisnosti o tome koja mu je radna točka iz tablice za pretraživanje najbliža trenutnoj radnoj točki. Razvijeni upravljački algoritma je potom validiran na nelinearnom simulacijskom modelu laboratorijske hidroelektrane koja se nalazi u Laboratoriju za napredne elektroenergetske mreže (SGLab) pri Fakultetu elektrotehnike i računarstva Sveučilišta u Zagrebu. Simulacijski rezultati su pokazali da predloženi upravljački algoritam ima potencijal za primjenu u sklopu turbinskog regulatora hidroelektrane. U drugom koraku provedena je praktična implementacija predloženog MPC algoritma na programibilnom logičkom kontroleru koji se koristi kao turbinski regulator laboratorijske hidroelektrane. Na ovaj način se validirala mogućnost praktične primjene predloženog MPC regulatora te usporedila kvaliteta odziva MPC regulatora s različitim tipovima regulatora, kao što su GS-PI (engl. Gain-Scheduled PI), PSO-PI te regulator zasnovan na eksponencijalnom upravljačkom zakonu (engl. Exponential Control Law – EXP), koji su za potrebe validacije predloženog MPC algoritma također implementirani na laboratorijskoj hidroelektrani. U tom smislu, napravljeni su eksperimenti u kojima je hidroelektrana bila sinkronizirana na mrežu te je za skokovitu promjenu postavne vrijednosti djelatne snage sniman odziv u slučajevima kad je svaki od prethodno spomenutih regulatora bio aktiviran. Kvaliteta odziva se validirala uspoređujući kriterije brzine odziva, nadvišenja i vremena potrebnog za stabilizaciju odziva. Neminimalno fazno vladanje koje je fizikalna značajka hidroelektrane u ovom slučaju nije promatrano budući da laboratorijska hidroelektrana ima veoma kratak cjevovod i tlak na izlazu iz cjevovoda je reguliran korištenjem vodene pumpe. Iz tog razloga kod promjene snage pad tlaka je praktično zanemariv. U pogledu ostalih kriterija hidroelektrana je korištenjem predloženog algoritma prediktivnog upravljanja imala najbrži odziv i najkraće vrijeme stabilizacije izlazne snage, dok su ostali tipovi regulatora pokazali superiornost u pogledu nadvišenja odziva. Što se tiče kriterija brzine i stabilizacije odziva ovdje treba istaknuti da je nakon MPC regulatora PSO-PI regulator imao najbrže vrijeme odziva i najkraće vrijeme stabilizacije izlazne snage elektrane, dok je EXP regulator imao najsporiye vrijeme odziva i najduže vrijeme potrebno za stabilizaciju izlazne snage hidroelektrane. Isto tako potrebno je istaknuti da su svi tipovi regulatora zadovoljili sve kriterije uz iznimku EXP regulatora koji nije zadovoljio u pogledu kriterija brzine odziva. Dakle, drugi korak provedenog istraživanja kao glavni cilj imao je popuniti prazninu između teorijskih razmatranja i praktične primjene naprednih upravljačkih rješenja za turbinsku regulaciju hidroelektrana. Nadalje, optimizacijski problem postavljen u sklopu MPC algoritma je u formi kvadratnog optimizacijskog problema (engl. Quadratic Programming – QP) koji uključuje ograničenja na minimalnu/maksimalnu brzinu promjene upravljačke veličine kao i na vrijednost minimalne/maksimalne amplitude upravljačke veličine. Dodatna prednost ovog istraživanja je u definiranju QP rješavača (engl. Solver) prikladnog za praktičnu implementaciju na PLC turbinskog regulatora. U tom smislu Hildrethov algoritam je korišten kao rješavač

---

koji je implementiran na PLC za rješavanje QP optimizacijskog problema u sklopu predstavljenog algoritma upravljanja. Ovaj tip rješavača pripada porodici takozvanih dualnih metoda za rješavanje QP optimizacijskih problema. Dakle, ovaj rješavač rješava dualni optimizacijski problem te pronalazi Lagrangeove multiplikatore koji definiraju aktivni set ograničenja primala. U slučaju da brzina konvergiranja Lagrangeovih multiplikatora nije zadovoljavajuća moguće je povećati broj iteracija koje se koriste za njihov izračun. Nakon što su izračunati Lagrangeovi multiplikatori izračunava se primal na način da se prvo pronade rješenje primala bez ograničenja te se oduzme korekcijski član koji uključuje aktivna ograničenja. Glavna prednost ovog tipa rješavača je njegova robustnost i jednostavnost implementacije na PLC.

U sklopu istraživanja također je predstavljena i troslojna hijerarhijska upravljačka struktura mikromreže u koju se može integrirati predloženi regulator snage hidroelektrane te koja također može poslužiti kao osnova za integraciju mikromreže na tržište električne energije. Naime, u sklopu predložene hijerarhijske strukture upravljanja mikromrežom prvi sloj je zadužen za dugoročnu optimizaciju pogona mikromreže, drugi sloj omogućuje da mikromreža koja je priključena na mrežu sudjeluje u regulaciji frekvencije. Treći sloj u predloženoj hijerarhijskoj strukturi predstavljaju lokalni regulatori na razini svake komponente mikromreže koji su zaduženi za praćenje postavnih vrijednosti primljenih iz prva dva sloja.

Izvršavanje hijerarhijske strukture upravljanja odvija se u sljedećim koracima. U prvom koraku poziva se prvi upravljački sloj koji je zadužen za dugoročnu optimizaciju pogona mikromreže u sklopu kojeg se rješava problem dinamičkog ekonomskog dispečiranja mikromreže. Rezultati ovog upravljačkog sloja su optimalne postavne vrijednosti snage za svaku upravljivu komponentu laboratorijske mikromreže. Predikcijski horizont prvog upravljačkog sloja je 15 minuta uz vremenski korak od 1 minute. U drugom koraku se rezultati prvog upravljačkog sloja proslijeđuju drugom upravljačkom sloju koji je zadužen za pružanje primarne regulacije frekvencije od strane mikromreže. U tom smislu drugi upravljački sloj je formuliran kad MPC algoritam s predikcijskim horizontom od 20 sekundi, koji u ovisnosti o odstupanju frekvencije radi korekcije postavnih vrijednosti upravljivih komponenti mikromreže. Ukoliko nema odstupanja frekvencije ne radi se korekcija postavnih vrijednosti primljenih od strane prvog upravljačkog sloja. U zadnjem koraku se postavne vrijednosti koje su rezultat drugog upravljačkog sloja proslijeđuju lokalnim regulatorima na razini svake komponente koji su zaduženi za praćenje primljenih postavnih vrijednosti od strane gornjih upravljačkih slojeva. U tom smislu, klasični regulator snage hidroelektrane koja je dio laboratorijske mikromreže mogao bi se zamijeniti regulatorom snage predstavljenim u ovom radu.

Sukladno navedenim koracima istraživanja definirana su dva doprinosa ove doktorske disertacije. U tom smislu ova doktorska disertacija za glavni cilj ima popuniti prazninu između teorijskih razmatranja i praktične primjene naprednih algoritama upravljanja u regulaciji snage hidroturbine.

---

Doprinosi doktorske disertacije su formulirani kako je navedeno u nastavku:

- Algoritam modelskog prediktivnog regulatora snage u sklopu turbinskog regulatora hidroelektrane.
- Metodologija izvedbe u stvarnom vremenu algoritma modelskog prediktivnog upravljanja koristeći programibilni logički kontroler te evaluacija njegovog potencijala za praktičnu primjenu u sklopu turbinskog regulatora hidroelektrane.

**Ključne riječi:** regulacija snage, Pelton turbina, programibilni logički kontroler, modelsko prediktivno upravljanje, turbinski regulator

# Contents

- 1. Introduction** . . . . . 1
  - 1.1. Background and motivation . . . . . 1
  - 1.2. Problem statement . . . . . 2
  - 1.3. Objective of the Thesis . . . . . 3
  - 1.4. Structure of the Thesis . . . . . 3
  
- 2. Hydro Turbine Governor** . . . . . 5
  - 2.1. Hydro Turbine Governor - Tuning Techniques . . . . . 6
    - 2.1.1. Classical Techniques . . . . . 6
    - 2.1.2. Optimization Techniques . . . . . 8
  - 2.2. Hydro Turbine Governors Based on Advanced Control Structures . . . . . 10
  - 2.3. Applications of MPC in Hydro Turbine Governors . . . . . 11
  - 2.4. Industrial Standards for Hydro Turbine Governors . . . . . 12
  - 2.5. Connections to the Contributions . . . . . 13
  
- 3. Hydro Power Plants - Modelling and Control** . . . . . 14
  - 3.1. Hydro Power Plant Models . . . . . 14
    - 3.1.1. Impulse Turbines . . . . . 18
  - 3.2. Model Predictive Controller . . . . . 19
    - 3.2.1. Constrained Quadratic Programming Formulation . . . . . 21
    - 3.2.2. Hildreth Algorithm . . . . . 21
  - 3.3. Quality of the Hydro Power Plant Response . . . . . 22
  
- 4. Main Scientific Contributions of the Thesis** . . . . . 23
  
- 5. List of Publications** . . . . . 25
  
- 6. Author’s Contributions to the Publications** . . . . . 26
  
- 7. Conclusion and Future Directions** . . . . . 28
  - 7.1. The Main Conclusions of the Thesis . . . . . 28

7.2. Future Research Directions . . . . .	29
<b>Bibliography</b> . . . . .	30
<b>Publications</b> . . . . .	40
<b>Biography</b> . . . . .	80
<b>Životopis</b> . . . . .	84



# Chapter 1

## Introduction

Stability of power systems is predominantly guaranteed by hydro power plants. Namely, in modern power systems hydro power plants are primarily used for frequency regulation due to their fast response capabilities, since large hydro power plants are capable of varying their power output over the entire operating region within 10-15 s. In that regard, a hydro turbine governor is a crucial component of any hydro power unit. Classical Proportional-Integral-Derivative (PID) controllers are the most commonly used controllers in the power sector. The main reason for this is their robustness and straightforward implementation. Although PID-based hydro turbine governors have been proven efficient in practical applications, their main disadvantage lies in the fixed parameters structure in which the parameters are selected upon the results of linear models. Since hydro power plants are highly nonlinear systems, to improve the response of the plant it is necessary to consider alternative control approaches where parameters of the controller are updated depending on the current operating point. This thesis proposes a model predictive control (MPC) based algorithm for the design of the hydro power plant's load/frequency controller whose internal linear prediction model parameters are being continuously updated depending on the current operating point. Furthermore, the introduced controller was experimentally validated on a laboratory hydro power plant.

### 1.1 Background and motivation

As highly nonlinear systems, hydro power plants' efficient operation requires control methods that take into account hard constraints and multivariable effects. Although many control methods include hard constraints of the plant, probably the most suitable control method that naturally deals with hard constraints on control variables is MPC [1], [2]. In that regard, it is reasonable to assume that MPC as a control method can be effectively applied in hydro turbine governor applications. By and large, MPC as a control method has been widely accepted and used for control of industrial and power plants with slow dynamics such as coal-fired ther-

mal power plants or heating, ventilation and air conditioning systems. An interested reader is referred to an overview of MPC applications in [3]. A considerable amount of literature is available on the application of MPC algorithms on coal/gas-fired thermal power plants, wind power plants, power converters or even nuclear power plants.

A great attention in the research community has been devoted to the control of power converters by using a finite control set-MPC, which is a form of explicit MPC algorithm [4], [5], [6]. Furthermore, the application of MPC control strategy for wind power plants was elaborated in [7], [8], [9] while applicability of an industrial MPC to thermal power plants was demonstrated in [10], [11], [12]. Additionally, a number of MPC-based approaches are also available for controlling a cascade of hydro power plants [13], [14], [15], [16]. The idea of applying MPC algorithm in hydro turbine governor applications is not entirely new [17]. However, there is still a lack of research that covers the gap between theoretical aspects and practical validation.

Increased computation capabilities of the latest generation of microprocessors and programmable logic controllers (PLC) used in the governor hardware have enabled the application of many advanced control methods in hydro turbine governors, e.g. robust control, adaptive control, sliding mode control, fuzzy-neural control and predictive control, all aiming to improve control characteristics of the plant over the entire operating region.

## 1.2 Problem statement

In terms of controlling active power output, the main characteristics of hydro power plants are their poorly damped poles, nonminimum-phase (NMP) dynamics and nonlinear relationships between mechanical power, volume flow of water and guide vane angle for Francis type of turbine or needle position for Pelton type of turbine [18]. Furthermore, the following nonlinearities are invariably included in hydro turbine governors:

- a fixed rate limit - this constraint is included to prevent excessive pressure variations in the penstock
- a saturation constraint - this constraint is included in the governor due to physical limitations of the actuator

Since hydro power plants are nonlinear systems, the PID based hydro turbine governors with fixed parameters can perform optimally only in the vicinity of the operating point chosen during governor design. In order to improve control characteristics of the hydro power plant over the entire operating envelope alternative control approaches should be considered. This research has the main goal to introduce an MPC based algorithm that can be used as an alternative to the existing classical PID based controllers. The main aim of the introduced algorithm is to increase the speed of the response of the hydro power plant, while at the same time preventing the violation of other criteria such as overshoot, undershoot and settling time. The thesis presents

an MPC algorithm for load/frequency controller of the hydro power plant whose internal linear prediction model parameters are updated depending on the current operating point. To make a fair comparison between the introduced MPC algorithm and PID based controller, the classical controller with fixed parameters has been replaced with gain-scheduled PI (GS-PI), particle swarm optimization PI (PSO-PI) and the controller based on exponential control law (EXP). In this manner, the quality of the MPC controller has been practically validated by comparing its response with the responses of the GS-PI, PSO-PI and EXP controllers.

### **1.3 Objective of the Thesis**

The research conducted in this thesis is oriented towards analyzing the possibility of applying an MPC based algorithm as an alternative to the widely accepted classical PID based load/frequency controllers in the hydro power plants. The objective of the conducted research is to formulate a quadratic programming (QP) problem that is used within the MPC controller. A linear models, in a form of transfer functions, are defined for laboratory hydro power plant's different operating points. These linear models have been used as a prediction models in the MPC algorithm. Furthermore, the developed MPC algorithm has been implemented in the PLC and validated on laboratory hydro power plant by comparing the response to the one of the GS-PI, PSO-PI, and EXP load/frequency controllers. In this manner, practical implementation potential of the developed MPC has been assessed.

The research hypotheses assumes that utilization of MPC algorithm as a load/frequency controller can lead to the improvement of the response characteristics of the hydro power plant compared to classical PID controllers.

The scientific contributions of the thesis are defined as follows:

1. Model predictive control algorithm for a load/frequency controller of a hydro turbine governor.
2. Methodology for real-time implementation of model predictive control algorithm using programmable logic controller, as well as an evaluation of MPC algorithm's practical implementation potential for a load/frequency controller of a hydro turbine governor.

### **1.4 Structure of the Thesis**

The thesis is organised as follows. The Chapter 2 provides an introduction and review of related work in the field of hydro turbine governors. The emphasis is given to the existing work on the application of MPC algorithms in hydro turbine governors. Chapter 3 briefly explains MPC as a control technique. The emphasis is given on modelling aspects of the hydro power plants and general structure of the MPC controller. Chapter 4 introduces the scientific contributions of

the thesis. Chapter 5 presents the list of all relevant publications, while Chapter 6 summarizes author's contributions to the publications. Finally, Chapter 7 concludes the thesis and introduces a potential direction for future research.

# Chapter 2

## Hydro Turbine Governor

As stated in Chapter 1 classical PID based controllers have been mainly used in hydro turbine governors. Generally speaking, the overall structure of each hydro turbine governor is made of two controllers, i.e. speed and load/frequency controller. The speed controller is only active during the start-up sequence, while the hydro power plant unit is being in the synchronisation procedure with the utility grid. The load/frequency controller is active only when the hydro power plant unit works in parallel with the utility grid. The tuning of these type of controllers is normally based on linear models. However, hydro power plants are nonlinear systems so any control law design based on linearised representation is a compromise. By and large, the main objective of controller's tuning is to achieve a good balance between sensitivity, control effort and the speed of response [19]. In that regard, the tuning procedure for parameters of PID controllers for hydro turbine governor is based on trade-off among the following criteria:

- primary response - at least 90% of demanded step power change should be realized within the specified time
- overshoot
- undershoot (NMP behavior)
- settling time.

Furthermore, the parameters of the controller should be chosen in the way that system has a reasonable values of the phase margin ( $30^\circ \leq P_m \leq 60^\circ$ ) and the gain margin ( $2 \leq G_m \leq 5$ ) [20]. Various techniques of governor tuning have been introduced in the literature for hydro turbine governors. These techniques not only indicate stability but also provide information on the adjustments needed to obtain a given specification of performance. The controller tuning techniques are applicable for PID controllers with both fixed and adaptive parameters structure, i.e. PID controllers whose parameters for different operating points have been chosen using meta-heuristic algorithms or fuzzy logic. Figure 2.1 shows the general overview of the PID controller tuning techniques. Tuning techniques in blue frames are the most commonly used in the literature for tuning the parameters of a hydro turbine governor.

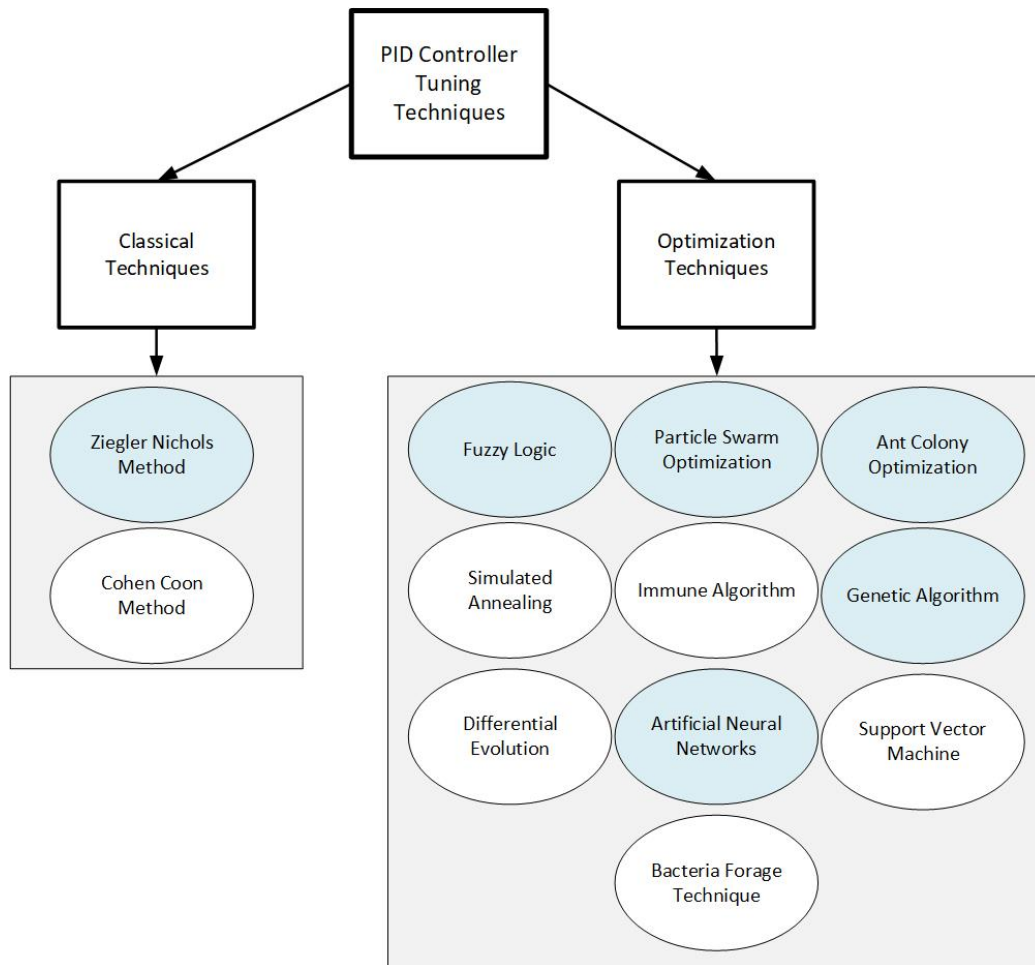

**Figure 2.1:** Overview of PID tuning techniques (based on analysis in [21], [22]).

## 2.1 Hydro Turbine Governor - Tuning Techniques

A large body of literature is available in the context of the PID controller design procedures for the hydro power plants. In the following Sections (2.1.1 and 2.1.2) we give an insight in the current state-of-the art for the classical tuning techniques and optimization tuning techniques for hydro turbine governors.

### 2.1.1 Classical Techniques

Generally speaking, by far the most popular tuning method in use for PID tuning is Ziechler-Nichols (ZN) method. In that regard, this technique is also very often used for tuning the PID controller available within the hydro turbine governor. The first step in applying this method is to set the integral and differential gains to zero. In the second step the value of proportional gain is increased until the system becomes unstable. The value of proportional gain  $K_p$  at the point of instability is called  $K_{MAX}$ , while the frequency of oscillation is  $f_0$ . In the last step, the value of proportional gain  $K_p$  is returned to a predetermined amount and the integral and differential

gains are calculated as a function of  $f_0$ . A flowchart for the ZN method is illustrated in Figure 2.2.

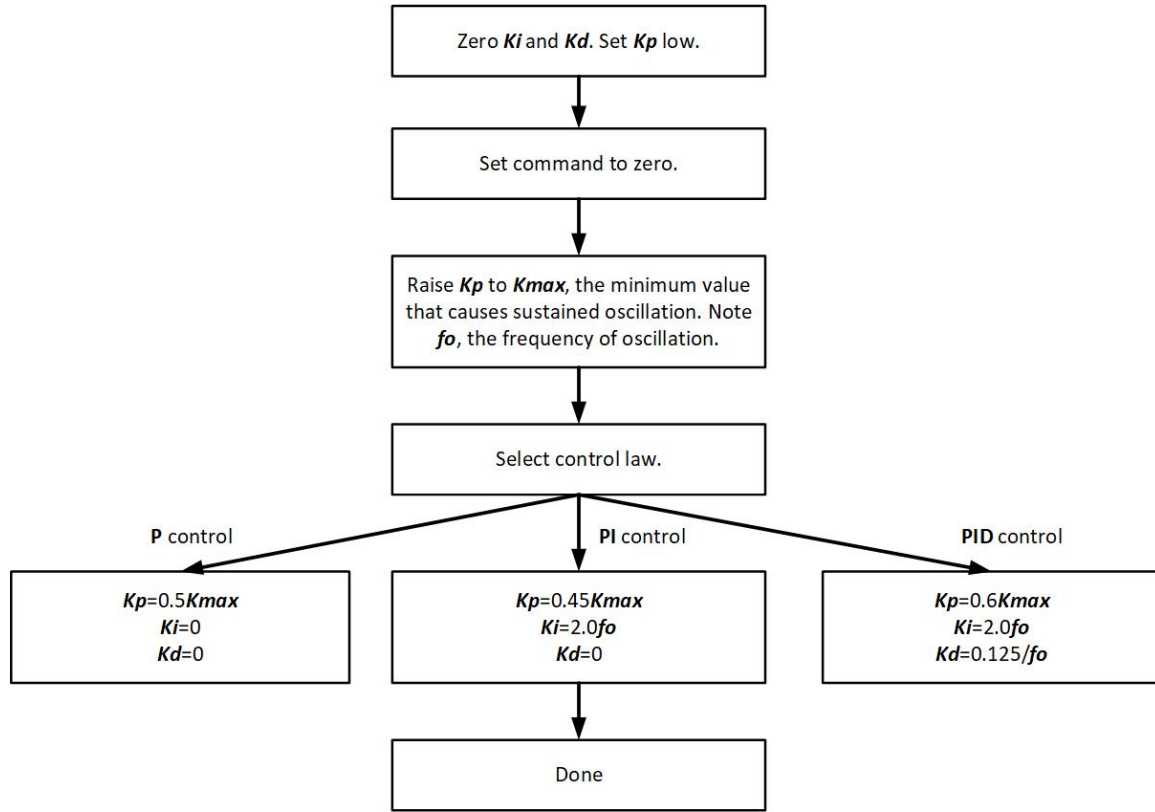

**Figure 2.2:** Ziegler–Nichols method for tuning P, PI, and PID controllers (adapted from [23]).

A numerous studies are available on hydraulic turbine models and hydro turbine governor PID design and classical tuning procedures [24], [25], [26]. A comprehensive review on hydro power plant model development and control is available in [27], [28], [29]. The performance of small scale hydro power plant using the classical PID controller is investigated in [30], [31]. The reader is also referred to [32], where a PID controller design for the control of hydraulic turbines over the entire operating envelope based on sensitivity margin specifications is presented. It is shown that due to the NMP behavior of hydraulic turbines, phase and gain margins as the commonly used PID controller performance indicators could be replaced with a more adequate metric, i.e. sensitivity margin. Furthermore, the pole placement method is also often used method for setting the parameters of PID controller in the hydro turbine governor. The pole placement design procedure for a gain-scheduled PID based speed and load/frequency controllers for hydro turbine governor is introduced in [33]. Additionally, a gain-scheduled controller for hydraulic turbine in which the PID controller parameters are calculated as a function of guide vane angle is elaborated in [34].

## 2.1.2 Optimization Techniques

Throughout the years, numerous findings were obtained for PID tuning methods for more performance-specific criteria and to deal with more complicated systems. In this regard, different optimization techniques were used to obtain optimal parameters of PID based controllers for different operating points. A large body of literature is available for the design of PID based hydro turbine governors using the PSO algorithms, fuzzy logic (FL), genetic algorithms (GA), ant colony optimization (ACO) or artificial neural networks (ANN).

Fuzzy logic can be considered as an interface between artificial intelligence and control engineering. The FL controller is integrated in the structure of conventional PID controller to adjust the parameters of the PID controller on-line according to the change of the signals error and change of the error. The structure of PID controller based on FL is illustrated in Figure 2.3.

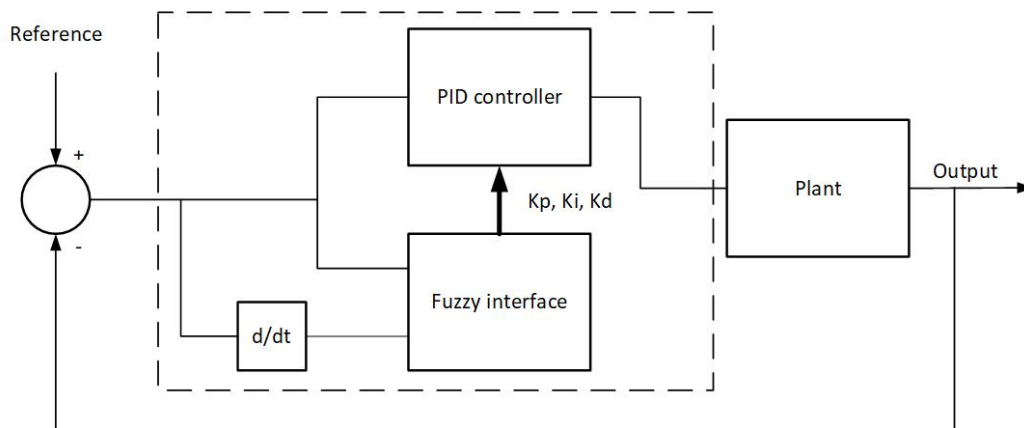

**Figure 2.3:** Structure of self tuning fuzzy PID controller (adapted from [35]).

Application of FL to obtain the PID parameters of hydro turbine governor is widespread in the literature. However, as with other optimization tuning techniques there is a lack of research that combines theoretical analysis with the experimental validation. Hydro turbine governor based on FL is elaborated in [36], [37], [38]. Hydro turbine governor based on FL was used to control hydro power plant with several hydraulically coupled turbines [36]. The results have shown that FL controller could replace the commonly used control arrangement in which each turbine has an independent PID based hydro turbine governor. Additionally, the fuzzy PID control strategy for controlling the governor of a hydro power plant during different fault conditions was proposed in [37]. The potential of fuzzy-neural logic for the development of power system stabilizers is introduced in [39], [40]. ANN algorithm was used to develop a control system that automatically adjusts the turbine speed based on the current operating conditions [41], [42].

In the context of optimization tuning techniques for the parameters of the hydro turbine governor a great attention in the research community was paid to the use of evolutionary algorithms. PSO algorithms are the most commonly technique used in PID tuning [43]. In PSO technique, there is population of particles. These particles move through the solution space to



find optimal solution based on a cost function. Integral absolute error (IAE), integral square error (ISE), integral time absolute error (ITAE) and integral time square error (ITSE) are the most commonly used types of cost functions in these algorithms. The system keeps a track of the best solution obtained in the previous iteration and each individual particle keeps a track of its own individual best solution. Based on these two principles, each particle moves to a new position decided by a velocity and its current position. The particle velocity is dependent on the global and particle's best solution. Furthermore, the GA algorithms are also often used for PID tuning [43]. The structure of PID controller based on GA-PID is illustrated in Figure 2.4.

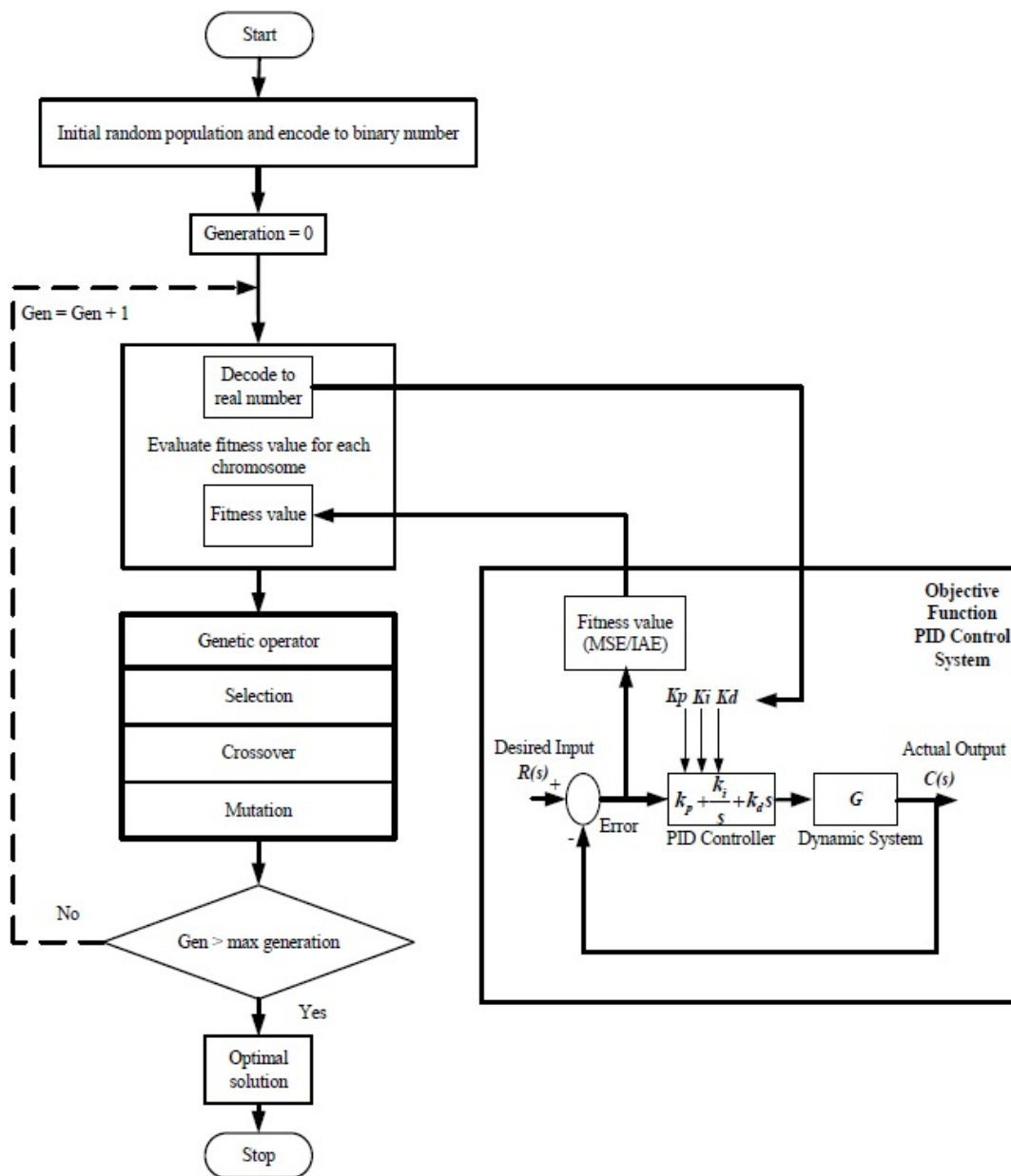

Figure 2.4: Structure of the GA-PID controller [44].

An improved evolutionary programming algorithm with a deterministic mutation factor for online PID parameters optimization of a hydro turbine governor is presented in [45]. The reader is also referred to [46], where the ACO technique was applied to obtain the parameters of the PID controller. The results have shown that the PID controller whose parameters are obtained in that way outperforms the PID controller with parameters obtained using the classical ZN technique. Furthermore, improved PSO techniques were applied for tuning the hydro turbine governor PID parameters [47], [48], [49]. The results of this research have shown that the PSO is an effective and easily implementable method for optimal tuning of PID parameters in a hydro turbine governor. Additionally, PSO technique have shown application potential for the development of power system stabilizers [50], [51].

## 2.2 Hydro Turbine Governors Based on Advanced Control Structures

In the context of advanced control algorithms, sliding mode control, robust control and EXP controllers are proven as a promising techniques that can be used for the design of hydro turbine governors.

Since hydro power plants, due to their role in primary frequency regulation, are crucial to enable stable operation of power system, a great research attention has been paid to the development of hydro turbine governors based on robust control algorithm. The reader is referred to [52], [53], [54], [55], [56], [57], where robust control algorithms are applied for the development of PID based hydro turbine governor. An algorithm for stability design of a pole-placement adaptive controller based on the parameter space method is introduced in [52]. The results have shown that the proposed controller is robust and can guarantee system stability over the entire plant's operating region. The dynamic behavior of hydraulically coupled turbines with emphasis on oscillations that occur at certain frequencies during the black start is investigated in [53]. In this case, a robust control techniques for the synthesis of the controller that takes into account these oscillations has been applied. Furthermore, a method for robust PID controller design is proposed in [54]. In this regard, the proposed controller has shown a good performance ensuring stability over many operating points in terms of guaranteed gain and phase margins. An interesting approach is proposed in [57], where an control algorithm based on optimal pole shift theory to damp out load angle and speed oscillations through the excitation and governor subsystems in a hydro power plant connected as single machine infinite bus system, is introduced.

The reader is also referred to [58], [59], [60], [61], [62], [63], [64], where a sliding mode control for hydro turbine governors is elaborated. A hydro turbine governor is designed using the control method of reduced-order sliding mode [58]. A group of parameters of the predefined

sliding surface is set up using a genetic algorithm, while a fuzzy interface system is utilized to decrease the chattering problem. A similar approach is used in [59], where a hydro turbine governor has been designed combining the sliding mode control with fuzzy logic. In this approach a predefined sliding surface guarantees the robustness of the controller, while the chattering phenomenon is mitigated by the fuzzy logic. Furthermore, a complimentary sliding mode controller for the control of variable speed hydro power plant is developed in [62]. The efficiency of the proposed controller over the wide range of operating conditions is demonstrated. The reader is also referred to [65], where a hydro power governor based on EXP controller is used to minimize the initial active power negative excursions due to the water hammer effect.

## 2.3 Applications of MPC in Hydro Turbine Governors

Predictive control algorithms, as advanced control algorithms, are also applicable for the design of hydro turbine governors. The reader is referred to [66], [17], [67] where MPC algorithms are applied for the design of hydro turbine governors. The predictive feedforward term is included in the structure of conventional hydro turbine governor [66]. The results have shown that in part-load operation mode the predictive feedforward term can significantly improve plant's response. Additionally, for practical application aspects it is important to emphasize that predictive feedforward term is incorporated in the structure of conventional governor with fixed-parameters structure. This implies that predictive feedforward term can easily be integrated in the governor's PLC. A generalized predictive control algorithm has been applied as a hydro turbine governor to a simulation model of a pumped storage hydro power plant [17]. The possibilities of the proposed predictive algorithm have been demonstrated by comparing the response of linear plant model with constrained predictive control algorithm with the response of conventional PI controller. The results have shown that predictive control algorithm could improve the plant's response over the entire operating region. Furthermore, a predictive control algorithm for the design of a hydro turbine governor based on neural networks is introduced in [67]. The proposed algorithm consists of one-step ahead neuropredictor and neurocontroller. The role of the neuropredictor is twofold. Namely, the first role of the neuropredictor is to track the dynamic characteristics of the plant, while the second role is to predict plant's output. The main role of the neurocontroller is to produce optimal control signal. The proposed algorithm is validated on a linear simulation plant model of the plant. Additionally, the reader is referred to [68], [69], [70], where control strategy based on an MPC algorithm has been applied for variable speed hydro power plants. An MPC controller was proposed to orchestrate the turbine controller with the virtual synchronous generator control of the power electronics converter used to integrate the hydro power plant in the grid. The conducted simulations have shown that the virtual synchronous generator control could provide fast power responses by utilizing the rotational energy

of the turbine and the generator, while at the same time the MPC algorithm controls the guide vane opening of the turbine to regain the nominal turbine rotational speed. To summarize, the main conclusion of the conducted studies is that the introduced predictive control system allows the variable speed hydro power plants to provide fast frequency reserves.

## 2.4 Industrial Standards for Hydro Turbine Governors

The applicable industrial standards for the hydro power plants are defined by the Hydroelectric Power IEEE Subcommittee. The main intention of these standards is to provide the guidelines for operation and maintenance of the hydro power plants. The overview of the most relevant industrial standards with respect to hydro turbine governors is given in Table 2.1.

**Table 2.1:** Overview of industrial standards for hydro turbine governors.

Standard	Short description
IEEE Std. 125-2007 [71]	This standard recommends performance characteristics and equipment for electric-hydraulic governors for all types of hydraulic turbines intended to drive electric generators of all sizes.
IEEE Std. 1010-2006 [72]	This standard describes the control and monitoring requirements for equipment and systems associated with all types of hydro power plants. It includes typical methods of local and remote control, details of the control interfaces for plant equipment, and requirements for centralized and off-site control.
IEEE Std. 1020-1988 [73]	This standard is a guide with the objective of assisting in the planning, design, development and operation of control systems for small scale hydro power plants.
IEEE Std. 1147-2005 [74]	This standard describes some alternatives that should be considered before carrying out a rehabilitation of hydro power plants.
IEEE Std. 1207-2004 [75]	This guide provides application details and addresses the impact of plant and system features on hydro power unit governing performance.
IEEE Std. 1248-1998 [76]	This guide describes tests performed and provides processes to be followed during the commissioning of electrical and control systems in hydro power plants.
IEEE Std. 1249-1996 [77]	This guide addresses the application, design concepts, and implementation of computer-based control systems for hydro power plant automation.

## **2.5 Connections to the Contributions**

The literature review presented in Chapter 2 showed that comprehensive work in the area of hydro turbine governors already exists. The first contribution of the thesis is related with different types of controllers used in hydro turbine governors that are discussed in Sections 2.1.1, 2.1.2, 2.3, 2.4. Namely, these sections elaborated currently available control algorithms in the literature for hydro turbine governors. The first contribution of this thesis is an extension of the existing body of knowledge by introducing a load/frequency controller of the hydro turbine governor based on MPC algorithm whose prediction model coefficients are updated depending on the current operating point. Furthermore, the literature review also revealed a gap between theoretical contributions and industrial practice. The intention of the thesis's second contribution is to fill this gap and to analyse a practical implementation potential of the proposed predictive control algorithm.

## Chapter 3

# Hydro Power Plants - Modelling and Control

This chapter briefly introduces the reader with the main elements of the hydro power plant and the fundamental relationships between the elements of the hydro power plant. The modelling details for the components of the laboratory hydro power plant which is used for experimental validations are omitted intentionally from this chapter and only the operating principle of the hydro power plant is discussed. However, the reader is referred to [Pub1], [Pub2], where modeling details for the components of the laboratory hydro power plant are available.

Over the last couple of decades, increasing concern about the pollution of environment triggered the investments in small-scale hydro power plants. The main advantages of small-scale hydro power plants compared to the conventional hydro power plants are significantly lower investment cost and lower environmental footprint. By and large, the small-scale hydro power plants are not associated with environmental degradation because of reduced levels of civil-engineering activities and negligible capacity of water impoundment. In the literature, there is no clear consensus on the upper limit for the definition of small-scale hydro power plants. However, a Table 3.1 gives a general classification of small-scale hydro power plants with respect to the installed capacity. Important to emphasize is that the laboratory hydro power plant used for experimental testing has rated power of 20 kVA which means it can be classified as a microhydro power plant.

### 3.1 Hydro Power Plant Models

The large change in behavior of nonlinear plants across its operating region requires different control objectives. In that regard, different control actions are required for each variation in the operating point. The nonlinear dynamic characteristics of hydro power plants are dependent on a set point change and disturbances, causing a shift from its optimum operating point. A

**Table 3.1:** Classification of small-scale hydro power plants with respect to installed capacity.

Classification	Installed Capacity
Picohydro	$\leq 5$ kW [78] $\leq 10$ kW [79]
Microhydro	$\leq 20$ kW [80] between 5 kW and 100 kW [81], [82] $\leq 100$ kW [83] between 10 kW and 200 kW [84] $\leq 500$ kW [79]
Mini hydro	between 500 kW and 2 MW [79]
Small hydro	$\leq 10$ MW [85] between 100 kW and 10 MW [83] between 2.5 MW and 25 MW [79]

crucial component of any hydro power plant is a hydro turbine governor, which provides a means of controlling a frequency and power. As hydro power plants are highly nonlinear, the turbine model considered in the design of the hydro turbine governor plays a crucial role. In that regard, a great attention has been paid towards linearized models. Governor tuning based on classic techniques has been done using a linear representation of the turbine system. However, this tuning is valid only for small signal performance studies, i.e. in the vicinity of the operating points. This means that load variations should be within  $\pm 10\%$  of the rated power, while frequency variations should be  $\pm 1\%$  of the rated value. A linearized model is not suitable for large variations in power output ( $> \pm 25\%$  of the rated power) and frequency ( $> \pm 8\%$ ) [86]. Since hydraulic turbines have highly nonlinear characteristics that vary with the current operating point, i.e. with the unpredictable load on the unit, a controller with fixed-parameters structure can not perform optimally. Namely, the controller parameters are chosen for the worst operating conditions. In case of large variations of operating points to capture a nonlinear characteristics a different nonlinear models of the hydro power plant are required. The basic requirement for nonlinear hydro power plant model is to include the effect of water compressibility, i.e. inclusion of water wave reflections which occurs in the elastic-wall pipe carrying compressible fluid [87]. The type of hydro power plant model is specially important for plants with long penstock. Furthermore, a penstock-turbine model with elastic water column effect is also important for modelling a hydro power plants with long penstock and multiple units. Another important aspect that should be considered is hydraulic coupling that occurs between the units in the plant. The reader is referred to [88], [89], where hydraulic coupling effect between units in the plant is explained. Generally speaking, the research conducted so far in the field of hydro power plants is so comprehensive that is difficult to cover all aspects of

modelling, operation and control in various configurations. However, the general overview that summarizes the most commonly used hydro power plant models is illustrated in Figure 3.1.

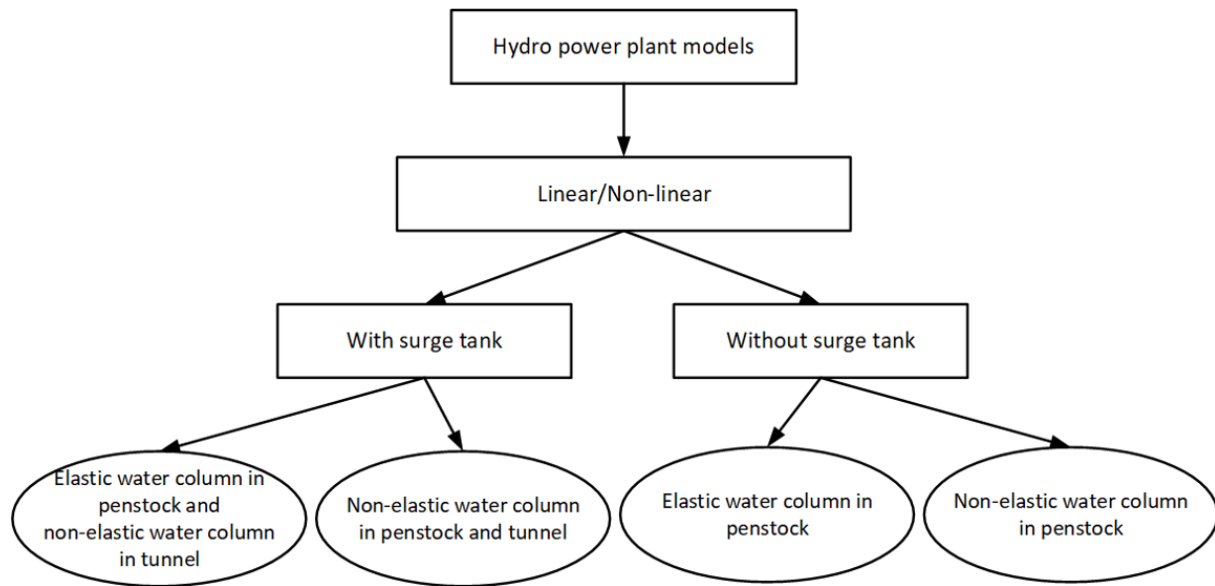

**Figure 3.1:** Overview of hydro power plant models (adapted from [27]).

Generally, the hydro power plant models can be classified as: linear (non-elastic) models and nonlinear (elastic) models. The linear models use equations linearized at an operating point, while nonlinear models use nonlinear relationship between mechanical power, turbine head, turbine flow and gate/needle opening depending on the type of turbine. Furthermore, in case of necessity for more detailed modelling a surge tank, if exist, could be incorporated in the hydro power plant model. Hydro turbine governor design is usually based on models with non-elastic column. These models are designed based on following assumptions: velocity of water proportional to gate position, inelastic penstock wall and incompressible water flow, turbine output proportional to the product of head and volume flow and negligible hydraulic resistance. If a more detailed model is needed, which takes into account the compressibility property of water and elastic property of the penstock, then a model with elastic water column effect is applied. In this type of model a pressure wave in the penstock is represented as a hydraulic transmission line terminated by an open circuit at the side of turbine and a short circuit at side of water reservoir [90], [91], [92]. These models are difficult to apply in system stability studies, since the parameters of the model are distributed.

The laboratory hydro power used for practical validation has a very short penstock. In that regard, it is reasonable to apply linear model with non-elastic water column for the development of plant prediction model used within the MPC algorithm. Although, the details on the plant parameters are available in [Pub1] and [Pub2], a detailed schematic diagram of the laboratory hydro power plant is illustrated in Figure 3.2. The main components of the laboratory hydro power plant are water reservoir with the pump, a penstock, Pelton turbine and synchronous



generator. The characteristics of the Pelton turbine are discussed in Section 3.1.1.

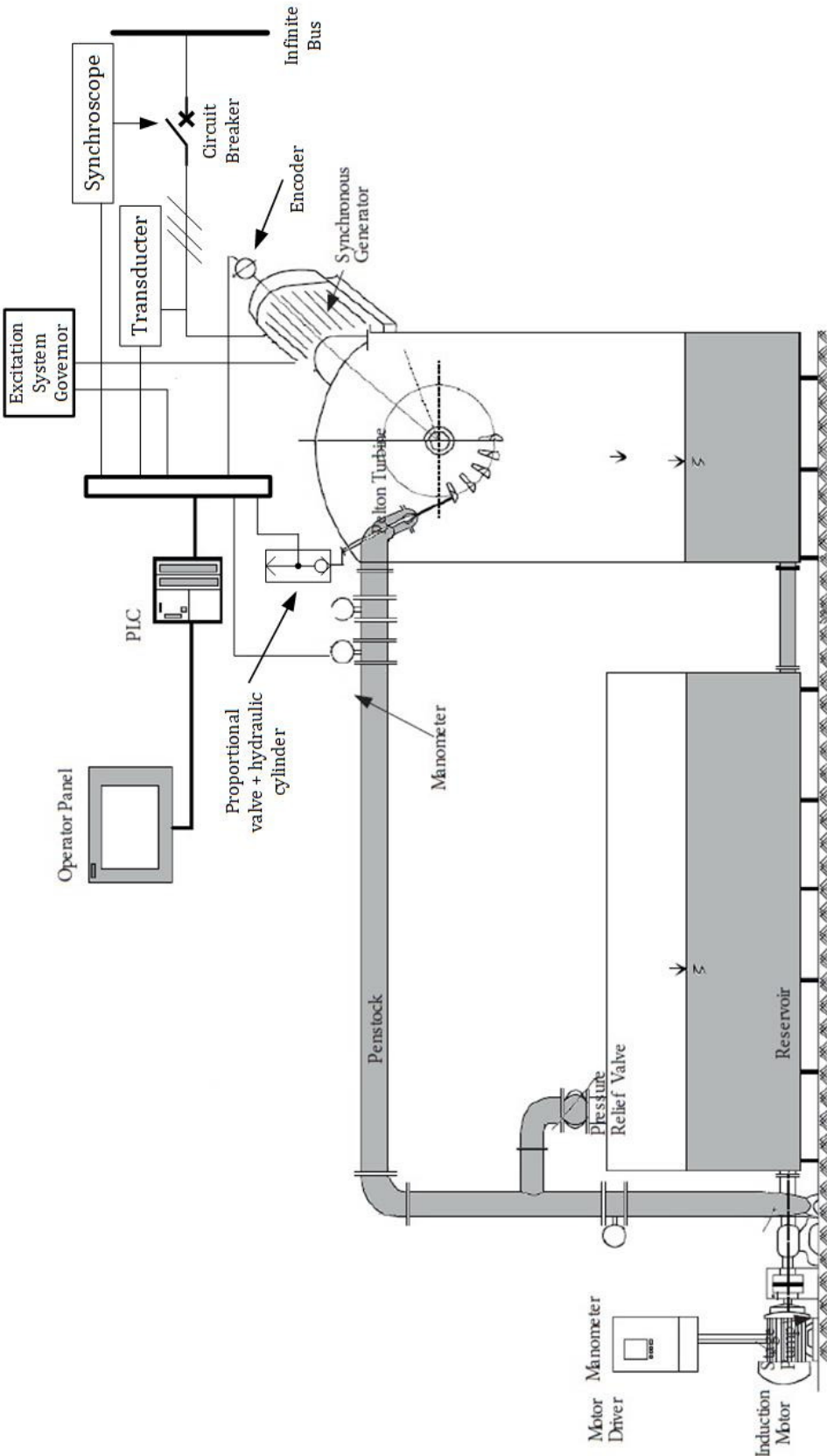
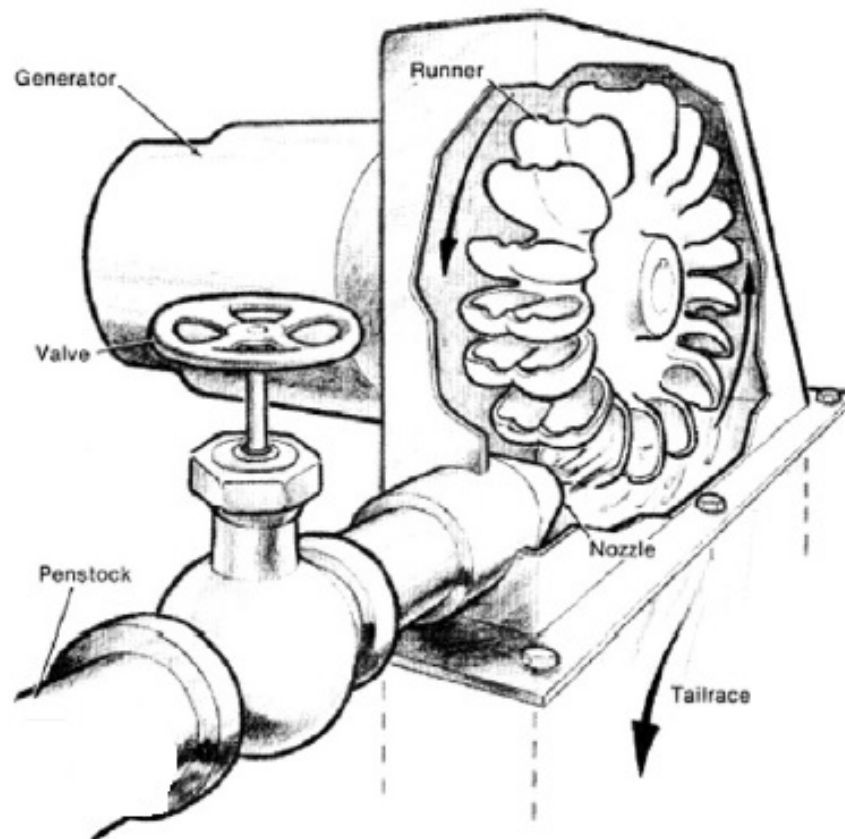

Figure 3.2: Schematic diagram of the laboratory hydro power plant in SGLab (adapted from [93]).

### 3.1.1 Impulse Turbines

The main characteristic of impulse turbines is that the hydraulic energy is first converted into kinetic energy in a form of free water jet by nozzles. Then the water jet from nozzles hits the turbine runner blades. This causes a change of momentum of the jet. Consequently, a force is created on the runner blades causing the rotation of the turbine. Furthermore, in impulse turbines the pressure across the turbine runner is constant at atmospheric pressure. This implies that the turbine runner is not submerged in the water. Compared to reaction turbines, impulse turbines do not require special pressure casing, which results in lower investments cost. The main representative of the impulse turbines is the Pelton turbine. Depending on the size of turbine, Pelton turbine can have one or more nozzles. Figure 3.3 illustrates the Pelton turbine with one nozzle, while Figure 3.4 explains the basic functioning of Pelton turbine. Namely, the water jet from nozzles hits buckets that are positioned around periphery of the rim. When the jet from nozzles hits the bucket it is split in half by a ridge, so each half of the jet is deflected and turned back. The deflection of the jet occurs at nearly  $180^\circ$  [94]. This maximizes the turbine power production. The jet, i.e. water flow, in Pelton turbines is controlled by a needle at the end of nozzle. Namely, the needle adjusts the flow through the nozzle to the turbine runner causing the power to increase or decrease.



**Figure 3.3:** Sketch of a small scale Pelton turbine [79].

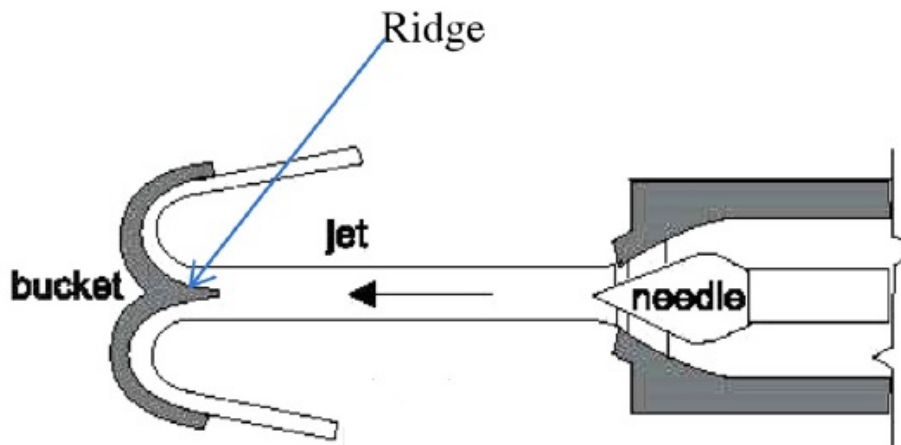

Figure 3.4: Basic functioning of a Pelton turbine [85].

## 3.2 Model Predictive Controller

This section briefly introduces the reader with MPC control technique. MPC is an advanced control technique of process control that is used to control a process, while satisfying a set of physical or economical constraints. A literature review in Section 2.3 has shown that the hydro turbine governor based on MPC algorithm has a potential to improve the performance of hydro power plant due to the integrated control approach and the following features:

- takes actuator limitations into account,
- enables the process to operate near constraints,
- has a short updating time,
- deals with multivariable processes.

MPC is a general name for all optimization based control techniques that find the future control sequence by looking for the minimum of a cost function over a fixed prediction horizon. Figure 3.5 illustrates the basic concept of MPC.

The basic operating principle of the MPC is to calculate, using the mathematical model of the plant, the predicted control signal over a defined horizon in the future. The control signal calculation is performed in a way to minimize the performance index. Furthermore, an MPC technique can also calculate future reference trajectory that the output of the system must follow. This thesis defines an MPC based load/frequency controller that produces reference trajectory for the controller that controls the positioning of the hydraulic piston. Namely, in case of laboratory hydro power plant used for experimental validation (refer to Figure 3.2) hydraulic piston is responsible for changing the position of the needle in the nozzle and consequently increase or decrease active power production of the plant.

As mentioned previously, the control sequence calculation is performed based on optimization criteria. The optimization criteria for a given control problem is defined in a form of objective function. The form of objective function and constraints in the formulation of the MPC algorithm depend on the goal of the applied MPC algorithm. Namely, the MPC algorithm can be applied to optimize operating cost of the process, e.g. power plant, microgrid, industrial facility, etc., or to improve the control characteristics of the plant. For instance, the reader is referred to [Pub3], where three-level hierarchical control approach for microgrids is introduced. The first two control levels are based on MPC, while the third one can use conventional controllers or MPC based controllers. The first control level is responsible for long-term behavior of the microgrid and ignores transient behavior of fast dynamic. The main goal of this control level is to minimize operating costs of the microgrid. In that regard, the first control level is an dynamic economic dispatch (DED) problem. The objective function and constraints are linear and the problem is set up as linear programming problem (LP). The second control level is responsible for primary frequency provision in grid-connected mode of microgrid operation. The optimization problem in this level is set up in a form of quadratic programming problem (QP). Furthermore, this control level is based on more accurate representation of specific devices within the microgrid and real-time control problem is solved on an aggregated level. The lowest control level in this control setup is responsible for tracking the optimal set points received from upper two control levels. This control level can be based on classical controllers or on MPC based controller introduced in this thesis.

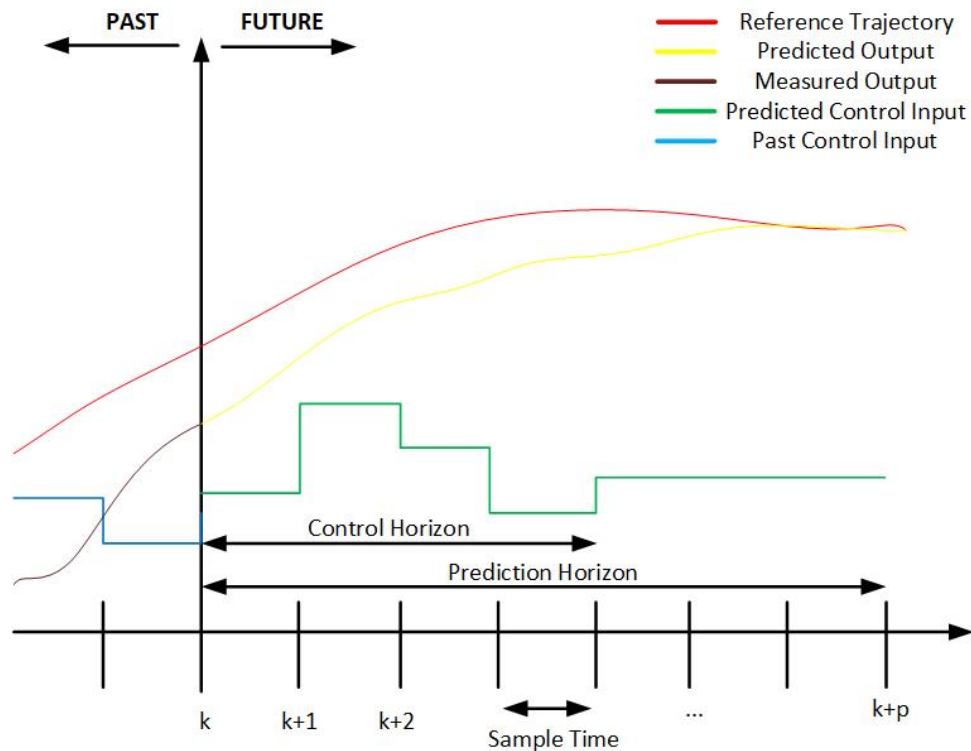

Figure 3.5: MPC strategy.

### 3.2.1 Constrained Quadratic Programming Formulation

An MPC based controller defined in this thesis is set up as an QP optimization problem. The standard QP optimization problem has been extensively investigated in the literature [95]. The QP optimization problem implies that objective functional  $f$  is quadratic and the constraints  $h$  and  $g$  are linear in  $x \in R^n$ . The general form of QP is defined as [96]:

$$\min f(x) := \frac{1}{2}x^T Bx - x^T b \quad (3.1)$$

over  $x \in R^n$

subject to:

$$A_1 x = c \quad (3.2)$$

$$A_2 x \leq d, \quad (3.3)$$

where  $B \in R^{n \times n}$  is symmetric,  $A_1 \in R^{m \times n}$ ,  $A_2 \in R^{p \times n}$ , and  $b \in R^n$ ,  $c \in R^m$ ,  $d \in R^p$ .

The QP (3.1)-(3.3) can be solved iteratively by active set strategies or interior point methods where each iteration requires the solution of an equality constrained QP problem.

### 3.2.2 Hildreth Algorithm

Hildreth's algorithm belongs to a family of dual methods for solving QP problems. Generally speaking, a dual method can be used systematically to identify the constraints that are not active. These constraints can be eliminated in the final solution of the QP problem. The reader is referred to [97], where a formulation of Hildreth's algorithms is given. However, in here we will point out the main advantages of this method. The main advantages of Hildreth's algorithm in solving QP problems can briefly be summarized as follows:

- relatively simple implementation of the algorithm,
- the algorithm does not require matrix inversion since it is based on element by element search,
- in case of infeasible solution the algorithm will use the unconstrained solution limited to the value of constraints.

Keeping in mind the above mentioned advantages the Hildreth's algorithm is chosen as a solver for solving the QP problem formulated for load/frequency controller in the hydro turbine governor. To summarize, the algorithm has ability to automatically recover from an ill-conditioned constrained problem which is essential for the safety of the plant operation.

### 3.3 Quality of the Hydro Power Plant Response

In order to validate the quality of the predictive controller response compared to other types of controllers the specification for the transient and steady-state responses of a hydro power plant operating in grid-connected mode should be defined. In that regard, the reader is referred to [98], where specifications of hydro power plant response are defined. When comparing the quality of the response between different types of load/frequency controllers implemented in the laboratory hydro power plant the criteria illustrated in Figure 3.6 are used.

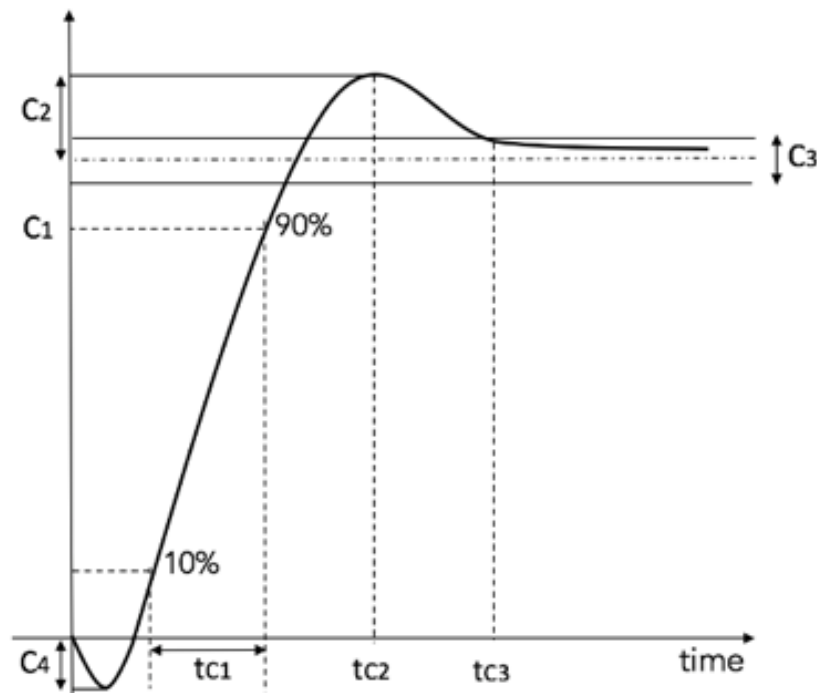

**Figure 3.6:** Specifications of the plant response [Pub4].

The first criterion  $C_1$  named primary response defines that at least 90% of demanded step power change should be realized within specified time  $tc_1$ . The second criterion  $C_2$  is related to the overshoot, while the third criterion  $C_3$  is related to settling time. It should be emphasized that the undershoot ( $C_4$  criterion) related to the NMP behavior of the hydro power plant is not considered in the evaluation of the quality of the response of different controllers, since the laboratory hydro power plant has a very short penstock and the water pressure at the end of penstock is regulated by the water pump.

# Chapter 4

## Main Scientific Contributions of the Thesis

The thesis has two scientific contributions. The first part of the thesis deals with the development and validation of a load/frequency predictive controller on a nonlinear simulation model of a laboratory hydro power plant available in SGLab at University of Zagreb Faculty of Electrical Engineering and Computing. The second part of the thesis deals with the practical implementation of the proposed MPC controller on the PLC that is used as a hydro turbine governor of the laboratory hydro power plant.

The achieved scientific contributions of the research conducted in this thesis are defined as follows:

### **1) Model predictive control algorithm for a load/frequency controller of a hydro turbine governor**

Hydro power plants are highly nonlinear systems whose power production control has numerous challenges. Industrial practice has shown that classical controllers with fixed-parameters can be used for controlling the hydro power plants. However, these controllers are conservatively designed for the worst case operating scenario. This implies that the plant operates optimally only in the vicinity of the operating point chosen during the controller design. The literature review conducted in Chapter 2 showed that alternative controllers based on parameters that are updated depending on the current operating point could improve the control characteristics of the plant.

We have introduced a load/frequency controller based on MPC algorithm whose internal prediction model coefficients are updated depending on the current operating point [Pub1], [Pub2], [Pub4]. Simulation results have shown that this controller could be used as an alternative to the existing classical controllers applied in practice.

### **2) Methodology for real-time implementation of model predictive control algorithm using programmable logic controller, as well as an evaluation of MPC algorithm's practical implementation potential for a load/frequency controller of a hydro turbine governor**

The literature review clearly indicated that there is a gap between theoretical contributions

and industrial practice with respect to the hydro turbine governor applications.

The introduced load/frequency controller based on MPC has been implemented on the PLC that serves as a hydro turbine governor of a laboratory hydro power plant [Pub2]. The practical implementation potential of the proposed predictive controller is validated by comparing the response of predictive controller with the responses of GS-PID, PSO-PID and EXP controllers. A currently existing gap between theoretical contributions and industrial practice has been reduced in this way.

Additional contribution of the research conducted in this thesis is the introduction of the three-level hierarchical control framework for optimal operation of the microgrids [Pub3]. The load/frequency predictive controller introduced in this thesis can be incorporated in the lowest control level responsible for tracking the optimal set points received from upper two control levels.



# Chapter 5

## List of Publications

The main publication, both journal and conference ones that are related to the thesis are listed as follows:

### Journal Papers

- [Pub<sub>1</sub>] M. Beus and H. Pandžić, “Application of an adaptive model predictive control algorithm on the pelton turbine governor control,” *IET Renewable Power Generation*, vol. 14, pp. 1720–1727, Apr. 2020, ISSN: 1752-1416. DOI: 10.1049/iet-rpg.2019.1291
- [Pub<sub>2</sub>] M. Beus and H. Pandžić, “Practical Implementation of a Hydro Power Unit Active Power Regulation Based on an MPC Algorithm,” *IEEE Transactions on Energy Conversion*, pp. 1–1, Jul. 2021, ISSN: 1558-0059. DOI: 10.1109/TEC.2021.3094059
- [Pub<sub>3</sub>] M. Beus, F. Banis, H. Pandžić, and N. Poulsen, “Three-level hierarchical microgrid control - model development and laboratory implementation,” *Electric Power System Research*, vol. 189, Dec. 2020, ISSN: 0378-7796. DOI: 10.1016/j.epsr.2020.106758

### Conference Papers

- [Pub<sub>4</sub>] M. Beus and H. Pandžić, “Application of Model Predictive Control Algorithm on a Hydro Turbine Governor Control,” in *2018 Power Systems Computation Conference (PSCC)*, IEEE, Jun. 2018, pp. 1–7. DOI: 10.23919/PSCC.2018.8442594

# Chapter 6

## Author's Contributions to the Publications

The research results presented in this thesis ([Pub1], [Pub2], [Pub3], [Pub4]) are based on the research conducted during the period 2017-2021 at the University of Zagreb Faculty of Electrical Engineering and Computing, Department of Energy and Power Systems under the guidance of the supervisor professor Hrvoje Pandžić, PhD. The results are related with the following research projects:

- Title: microGrid Positioning (uGrip); funding: SmartGrids Plus ERA-Net
- Title: Flexibility of Converter-based Microgrids (FLEXIBASE); funding: Croatian Science Foundation
- Title: Smart Integration of RENEwables (SIREN); funding: Croatian Science Foundation and Croatian Transmission System Operator (HOPS)
- Title: Universal Communication and Control System for Industrial Facilities (UKUS); funding: The European Regional Development Fund Operational programme Competitiveness and Cohesion

The thesis consists of 4 publications written in collaboration with coauthors. The author is listed as the leading author in all journal and a conference publications. The author's contributions to each published paper include manuscript writing and presentation, development of a control algorithm, establishing experimental setup and conducting experiments, and results analysis.

Author's contributions in each publication are defined as follows:

[Pub<sub>1</sub>] In the journal paper entitled: "*Application of an adaptive model predictive control algorithm on the Pelton turbine governor control*", the author: identified the need for advanced control approaches in hydro turbine governor applications, conducted literature review, develop load/frequency controller based on MPC, wrote the manuscript and analysed the results.

[Pub<sub>2</sub>] In the journal paper entitled: "*Practical Implementation of a Hydro Power Unit Active Power Regulation Based on an MPC Algorithm*", the author: formulated the predictive

control algorithm, conducted literature review, performed practical implementation of the predictive control algorithm on the PLC (establish laboratory setup), performed the experiments, wrote the manuscript and elaborated the results.

[Pub<sub>3</sub>] In the journal paper entitled: "*Three-level hierarchical microgrid control—model development and laboratory implementation*", the author: envisioned three level control framework for the microgrid, conducted literature review, formulated the first control level based on dynamic economic dispatch algorithm, established the experimental setup, performed the experiments and wrote the manuscript.

[Pub<sub>4</sub>] In the conference paper entitled: "*Application of Model Predictive Control Algorithm on a Hydro Turbine Governor Control*", the author: conducted literature review, defined the control algorithm, created the simulation model of the hydro power plant, wrote the paper and presented the paper at the conference.

# Chapter 7

## Conclusion and Future Directions

The presented thesis conducted through research in the field of hydro power plant control provided insights in the practical application potential of load/frequency controllers based on an MPC algorithm. The Section 7.1 will briefly summarize the main conclusions of the thesis, while Section 7.2 will define author's future research directions.

### 7.1 The Main Conclusions of the Thesis

The research conducted in this thesis is oriented towards analyzing the possibility of applying an MPC based algorithm as an alternative to the widely accepted PID based load/frequency controllers in the hydro power plants. The research started with the identification of all currently available types of load/frequency controllers in the literature. Although, different types of advanced controllers, including predictive controllers, have already been defined for hydro turbine governors, the literature review has revealed that there is a lack of research in the practical validation of advanced control algorithms in the hydro turbine governors. The intermediate step of conducted research was to define a load/frequency controller based on an MPC algorithm. The introduced algorithm includes the update of the coefficients of linear prediction model depending on the current operating point. The simulation results shows a superiority of this algorithm compared to the classical PID based load/frequency controllers. In the last step of conducted research the developed MPC algorithm has been implemented to the laboratory hydro power plant's governor PLC. To validate the practical application potential of the proposed algorithm the response of MPC based load/frequency controller has been compared to the responses of GS-PI, PSO-PI and EXP controllers. The results shows improved control characteristics of the plant. It is also shown that this type of control algorithm has a potential for practical application in hydro turbine governors.

## **7.2 Future Research Directions**

Each hydro turbine governor consists of two controllers, i.e. the load/frequency controller and the speed controller. The research conducted in this thesis is focused solely on the load/frequency controller which is active only when hydro power unit operates in parallel with the utility grid. This implies that additional research is possible with respect to the speed controllers. In that regard, the author's future research direction will be oriented towards developing a speed controller based on MPC algorithm and validating its practical implementation potential. In this way, a hydro turbine governor based on MPC algorithm could be applicable in all operating modes of the hydro power plant, i.e. grid-connected mode of operation and islanded mode of operation.

# Bibliography

- [1] J. M. Maciejowski, *Predictive control with constraints*, 1st ed. Prentice Hall, 2002.
- [2] E. F. Camacho and C. A. Bordons, *Model Predictive Control*, 2nd ed. Springer, 2007.
- [3] S. J. Qin and T. A. Badgwell, “A survey of industrial model predictive control technology,” *Control Engineering Practice*, vol. 11, pp. 733–764, 2003. DOI: 10.1016/S0967-0661(02)00186-7.
- [4] T. Dragičević, “Model Predictive Control of Power Converters for Robust and Fast Operation of AC Microgrids,” *IEEE Transactions on Power Electronics*, vol. 33, pp. 6304–6317, 2018. DOI: 10.1109/TPEL.2017.2744986.
- [5] Y. Zhang, J. Liu, H. Yang, and S. Fan, “New Insights Into Model Predictive Control for Three-Phase Power Converters,” *IEEE Transactions on Industry Applications*, vol. 55, pp. 1973–1982, 2019. DOI: 10.1109/TIA.2018.2873505.
- [6] M. Tomlinson, H. d. T. Mouton, R. Kennel, and P. Stolze, “A Fixed Switching Frequency Scheme for Finite-Control-Set Model Predictive Control—Concept and Algorithm,” *IEEE Transactions on Industrial Electronics*, vol. 63, pp. 7662–7670, 2016. DOI: 10.1109/TIE.2016.2593997.
- [7] A. J. Sguarezi Filho, M. E. de Oliveira Filho, and E. Ruppert Filho, “A Predictive Power Control for Wind Energy,” *IEEE Transactions on Sustainable Energy*, vol. 2, pp. 97–105, 2011. DOI: 10.1109/TSTE.2010.2088408.
- [8] L. Henriksen, M. Hansen, and N. Poulsen, “Wind turbine control with constraint handling: a model predictive control approach,” *IET Control Theory and Applications*, vol. 6, pp. 97–105, 2012, ISSN: 1751-8644. DOI: 10.1049/iet-cta.2011.0488.
- [9] W. Qi, J. Liu, X. Chen, and P. D. Christofides, “Supervisory Predictive Control of Standalone Wind/Solar Energy Generation Systems,” *IEEE Transactions on Control Systems Technology*, vol. 19, pp. 199–207, 2011. DOI: 10.1109/TCST.2010.2041930.
- [10] C. Aurora, L. Magni, R. Scattolini, P. Colombo, F. Pretolani, and G. Villa, “Predictive control of thermal Power Plants,” *International Journal of Robust and Nonlinear Control*, vol. 14, pp. 415–433, 2004. DOI: 10.1002/rnc.890.

- [11] M. Draganescu, S. Guo, J. Wojcik, J. Wang, X. Liu, G. Hou, Y. Xue, and Q. Gao, “Generalized Predictive Control for superheated steam temperature regulation in a supercritical coal-fired power plant,” *CSEE Journal of Power and Energy Systems*, vol. 1, pp. 69–77, 2015. DOI: 10.17775/CSEEJPES.2015.00009.
- [12] A. Krishnany, B. V. Patilx, H. B. Gooiy, and K. V. Lingy, “Predictive control based framework for optimal scheduling of combined cycle gas turbines,” in *2016 American Control Conference (ACC)*, IEEE, Jun. 2016, pp. 6066–6072. DOI: 10.1109/ACC.2016.7526622.
- [13] C. Setz, A. Heinrich, P. Rostalski, G. Papafotiou, and M. Morari, “Application of Model Predictive Control to a Cascade of River Power Plants,” *IFAC Proceedings Volumes*, vol. 41, pp. 11 978–11 983, 2008. DOI: 10.3182/20080706-5-KR-1001.02027.
- [14] J. M. Maestre, M. A. Ridao, A. Kozma, C. Savorgnan, M. Diehl, M. D. Doan, A. Sadowska, T. Keviczky, B. De Schutter, H. Scheu, W. Marquardt, F. Valencia, and J. Espinosa, “A comparison of distributed MPC schemes on a hydro-power plant benchmark,” *Optimal Control Applications and Methods*, vol. 36, pp. 306–332, 2015. DOI: 10.1002/oca.2154.
- [15] D. Faille, F. Davelaar, S. Murgey, and D. Dumur, “Hierarchical Model Predictive Control applied to Hydro Power Valley,” *IFAC Proceedings Volumes*, vol. 45, pp. 295–300, 2012. DOI: 10.3182/20120902-4-FR-2032.00053.
- [16] N. R., L. Z., and H. H., *Intelligent Systems, Control and Automation: Science and Engineering*. Springer, Dordrecht, 2009, vol. 42. DOI: 10.1007/978-90-481-3598-1\_18.
- [17] G. A. M. Munoz-Hernandez and D. Jones, “MIMO Generalized Predictive Control for a Hydroelectric Power Station,” *IEEE Transactions on Energy Conversion*, vol. 21, pp. 921–929, 2006. DOI: 10.1109/TEC.2005.860405.
- [18] P. Kundur, *Power System Stability and Control*. New York: McGraw-Hill, 2000.
- [19] J. A. Rossiter, *Model-Based Predictive Control - A Practical Approach*, 1st ed. CRC Press, Boca Raton, 2003, p. 344. DOI: 10.1201/9781315272610.
- [20] K. J. Astrom and R. M. Murray, *Feedback Systems: An Introduction for Scientists and Engineers*, 1st ed. Princeton University Press, 2008.
- [21] R. P. Borase, D. K. Maghade, S. Sondkar, and S. N. Pawar, “A review of PID control, tuning methods and applications,” *International Journal of Dynamics and Control*, vol. 9, pp. 818–827, 2021. DOI: 10.1007/s40435-020-00665-4.

- [22] H. O. Bansal, R. Sharma, and P. R. Shreeraman, "PID Controller Tuning Techniques: A Review," *Journal of Control Engineering and Technology*, vol. 2, pp. 168–176, 2012.
- [23] G. Ellis, *Control System Design Guide, Chapter 6 - Four Types of Controllers*, 4th ed. Butterworth-Heinemann, 2012, pp. 97–114. DOI: 10.1016/B978-0-12-385920-4.00006-0.
- [24] W. G. P. Mover and E. Supply, "Hydraulic turbine and turbine control models for system dynamic studies," *IEEE Transactions on Power Systems*, vol. 7, pp. 167–179, 1992. DOI: 10.1109/59.141700.
- [25] I. Power and E. Society, "Dynamic models for turbine-governors in power system studies," IEEE, Tech. Rep., 2013.
- [26] J. Culberg, M. Negnevitsky, and K. A. Kashem, "Hydro-turbine governor control: theory, techniques and limitations," in *Australasian Universities Power Engineering Conference (AUPEC 2006)*, 2006, pp. 1–7.
- [27] N. Kishor, R. P. Saini, and S. P. Singh, "A review on hydropower plant models and control," *Renewable and Sustainable Energy Reviews*, vol. 11, pp. 776–796, 2007, ISSN: 1364-0321. DOI: 10.1016/j.rser.2005.06.003.
- [28] R. Kumari, K. Desingu, T. R. Chelliah, and S. V. A. Sharma, "Development Trends and Future Prospects of Hydro-Turbine Control Systems," in *2019 IEEE Industry Applications Society Annual Meeting*, IEEE, 2019, pp. 1–10. DOI: 10.1109/IAS.2019.8912312.
- [29] R. R. Bajya and M. R. Taparia, "Modeling of a nonlinear hydro power plant and analysis with PID controllers," in *2016 International Conference on Control, Computing, Communication and Materials (ICCCCM)*, 2016, pp. 1–3. DOI: 10.1109/ICCCCM.2016.7918262.
- [30] P. Pravin and J. J. Abdul, "Performance evaluation of an isolated small hydro power plant using conventional controllers," in *2013 International Conference on Circuits, Power and Computing Technologies (ICCPCT)*, 2013, pp. 58–62. DOI: 10.1109/ICCPCT.2013.6528907.
- [31] N. Sobhan, "Automatic generation control and monitoring the mechanism of micro hydro power plant with impulse turbine and synchronous generator," in *2016 2nd International Conference on Robotics and Artificial Intelligence (ICRAI)*, 2016, pp. 175–179. DOI: 10.1109/ICRAI.2016.7791249.



- [32] P. Hušek, “PID controller design for hydraulic turbine based on sensitivity margin specifications,” *International Journal of Electrical Power and Energy Systems*, vol. 55, pp. 460–466, 2014, ISSN: 0142-0615. DOI: 10.1016/j.ijepes.2013.09.029.
- [33] B. Strah, O. Kuljaca, and Z. Vukic, “Speed and active power control of hydro turbine unit,” *IEEE Transactions on Energy Conversion*, vol. 20, pp. 424–434, 2005. DOI: 10.1109/TEC.2004.837278.
- [34] G. Orelind, L. Wozniak, J. Medanic, and T. Whittemore, “Optimal PID gain schedule for hydrogenerators-design and application,” *IEEE Transactions on Energy Conversion*, vol. 4, pp. 300–307, 1989. DOI: 10.1109/60.43228.
- [35] Z. Zulfatman and M. F. Rahmat, “Application of self-tuning Fuzzy PID controller on industrial hydraulic actuator using system identification approach,” *The International Journal on Smart Sensing and Intelligent Systems*, vol. 2, pp. 246–261, 2009.
- [36] M. Mahmoud, K. Dutton, and M. Denman, “Design and simulation of a nonlinear fuzzy controller for a hydropower plant,” *Electric Power Systems Research*, vol. 73, pp. 87–99, 2005, ISSN: 0378-7796. DOI: 10.1016/j.epsr.2004.05.006.
- [37] A. Sami, M. B. Kadri, N. Aziz, and Z. Pirwani, “Design and simulation of fuzzy PID for hydro power plant,” in *2016 Sixth International Conference on Innovative Computing Technology (INTECH)*, 2016, pp. 683–687. DOI: 10.1109/INTECH.2016.7845077.
- [38] R. Fan, J. Zhao, B. Pan, N. Chen, T. Wang, and H. Ma, “Automatic generation control of three-area small hydro system based on fuzzy PID control,” in *2014 International Conference on Power System Technology*, 2014, pp. 2522–2528. DOI: 10.1109/POWERCON.2014.6993826.
- [39] S. Radaideh, I. Nejdawi, and M. Mushtaha, “Design of power system stabilizers using two level fuzzy and adaptive neuro-fuzzy inference systems,” *International Journal of Electrical Power and Energy Systems*, vol. 35, pp. 47–56, 2012, ISSN: 0142-0615. DOI: 10.1016/j.ijepes.2011.08.022.
- [40] H. E. Talaat, A. Abdenmour, and A. A. Al-Sulaiman, “Design and experimental investigation of a decentralized GA-optimized neuro-fuzzy power system stabilizer,” *International Journal of Electrical Power and Energy Systems*, vol. 32, pp. 751–759, 2010, ISSN: 0142-0615. DOI: 10.1016/j.ijepes.2010.01.011.
- [41] J. Fraile-Ardanuy, J. Wilhelmi, J. Fraile-Mora, and J. Perez, “Variable-speed hydro generation: operational aspects and control,” *IEEE Transactions on Energy Conversion*, vol. 21, pp. 569–574, 2006. DOI: 10.1109/TEC.2005.858084.

- [42] D. Borkowski and T. Węgiel, “Small Hydropower Plant With Integrated Turbine-Generators Working at Variable Speed,” *IEEE Transactions on Energy Conversion*, vol. 28, pp. 452–459, 2013. DOI: 10.1109/TEC.2013.2247605.
- [43] M. El-Telbany, “Employing Particle Swarm Optimizer and Genetic Algorithms for Optimal Tuning of PID Controllers: A Comparative Study,” *Automatic Control and System Engineering Journal*, vol. 7, pp. 49–54, 2007, ISSN: 1687-4811.
- [44] M. S. Saad, H. Jamaluddin, and I. Darus, “PID controller tuning using evolutionary algorithms,” *WSEAS Transactions on Systems and Control archive*, vol. 7, pp. 139–149, 2012.
- [45] C. Jiang, Y. Ma, and C. Wang, “PID controller parameters optimization of hydro-turbine governing systems using deterministic-chaotic-mutation evolutionary programming (DCMEP),” *Energy Conversion and Management*, vol. 47, pp. 1222–1230, 2006, ISSN: 0196-8904. DOI: 10.1016/j.enconman.2005.07.009.
- [46] O. Singh and A. Verma, “Frequency Control for Stand-Alone Hydro Power Plants using Ant Colony Optimization,” in *2020 IEEE International Conference on Advent Trends in Multidisciplinary Research and Innovation (ICATMRI)*, 2020, pp. 1–6. DOI: 10.1109/ICATMRI51801.2020.9398417.
- [47] H. Fang, L. Chen, and Z. Shen, “Application of an improved PSO algorithm to optimal tuning of PID gains for water turbine governor,” *Energy Conversion and Management*, vol. 52, pp. 1763–1770, 2011, ISSN: 0196-8904. DOI: 10.1016/j.enconman.2010.11.005.
- [48] C. Gonggui, D. Yangwei, G. Yanyan, H. Shanwai, and L. Lilan, “PID Parameters Optimization Research for Hydro Turbine Governor by an Improved Fuzzy Particle Swarm Optimization Algorithm,” *The Open Electrical and Electronic Engineering Journal*, vol. 10, pp. 101–117, 2016, ISSN: 1874-1290. DOI: 10.2174/1874129001610010101.
- [49] A. V. Jha, D. K. Gupta, and B. Appasani, “The PI Controllers and its optimal tuning for Load Frequency Control (LFC) of Hybrid Hydro-thermal Power Systems,” in *2019 International Conference on Communication and Electronics Systems (ICCES)*, 2019, pp. 1866–1870. DOI: 10.1109/ICCES45898.2019.9002150.
- [50] H. E. Mostafa, M. A. El-Sharkawy, A. A. Emary, and K. Yassin, “Design and allocation of power system stabilizers using the particle swarm optimization technique for an interconnected power system,” *International Journal of Electrical Power and Energy Systems*, vol. 34, pp. 57–65, 2012, ISSN: 0142-0615. DOI: 10.1016/j.ijepes.2011.09.005.

- [51] E. Ali and S. Abd-Elazim, “BFOA based design of PID controller for two area Load Frequency Control with nonlinearities,” *International Journal of Electrical Power and Energy Systems*, vol. 51, pp. 224–231, 2013, ISSN: 0142-0615. DOI: 10.1016/j.ijepes.2013.02.030.
- [52] O. Malik and Y. Zeng, “Design of a robust adaptive controller for a water turbine governing system,” *IEEE Transactions on Energy Conversion*, vol. 10, pp. 354–359, 1995.
- [53] H. V. Pico, D. Aliprantis, J. McCalley, N. Elia, and N. Castrillon, “Analysis of hydro-coupled power plants and design of robust control to damp oscillatory modes,” in *2015 IEEE Power Energy Society General Meeting*, 2015, pp. 1–6. DOI: 10.1109/PESGM.2015.7285611.
- [54] K. Natarajan, “Robust PID controller design for hydroturbines,” *IEEE Transactions on Energy Conversion*, vol. 20, pp. 661–667, 2005. DOI: 10.1109/TEC.2005.845448.
- [55] J. Jiang, “Design of an optimal robust governor for hydraulic turbine generating units,” *IEEE Transactions on Energy Conversion*, vol. 10, pp. 188–194, 1995. DOI: 10.1109/60.372586.
- [56] J. Liang, X. Yuan, Y. Yuan, Z. Chen, and Y. Li, “Nonlinear dynamic analysis and robust controller design for Francis hydraulic turbine regulating system with a straight-tube surge tank,” *Mechanical Systems and Signal Processing*, vol. 85, pp. 927–946, 2017, ISSN: 0888-3270. DOI: 10.1016/j.ymsp.2016.09.026.
- [57] N. Kishor, “Oscillation Damping With Optimal Pole-Shift Approach in Application to a Hydro Plant Connected as SMIB System,” *IEEE Systems Journal*, vol. 3, pp. 317–330, 2009. DOI: 10.1109/JSYST.2009.2022577.
- [58] C. Xu and D. Qian, “Governor Design for a Hydropower Plant with an Upstream Surge Tank by GA-Based Fuzzy Reduced-Order Sliding Mode,” *Energies*, vol. 8, pp. 13 442–13 457, 2015. DOI: 10.3390/en81212376.
- [59] X. Yuan, Z. Chen, Y. Yuan, and Y. Huang, “Design of fuzzy sliding mode controller for hydraulic turbine regulating system via input state feedback linearization method,” *Energy*, vol. 93, pp. 173–187, 2015. DOI: 10.1016/j.energy.2015.09.025.
- [60] D. Qian, J. Yi, and X. Liu, “Design of reduced order sliding mode governor for hydro-turbines,” in *Proceedings of the 2011 American Control Conference*, 2011, pp. 5073–5078. DOI: 10.1109/ACC.2011.5991268.

- [61] Z. Chen, X. Yuan, Y. Yuan, X. Lei, and B. Zhang, "Parameter estimation of fuzzy sliding mode controller for hydraulic turbine regulating system based on HICA algorithm," *Renewable Energy*, pp. 551–565, ISSN: 0960-1481. DOI: 10.1016/j.renene.2018.10.061.
- [62] R. Kumari, K. K. Prabhakaran, K. Desingu, T. R. Chelliah, and S. V. A. Sarma, "Improved Hydroturbine Control and Future Prospects of Variable Speed Hydropower Plant," *IEEE Transactions on Industry Applications*, vol. 57, pp. 941–952, 2021. DOI: 10.1109/TIA.2020.3028798.
- [63] A. H. Kardile, S. M. Mule, R. M. Nagarale, and U. D. Shiurkar, "Small Hydro Power Plant control based on Fuzzy Sliding Mode Controller using Particle Swarm Optimization algorithm," in *2016 International Conference on Electrical, Electronics, and Optimization Techniques (ICEEOT)*, 2016, pp. 1274–1280. DOI: 10.1109/ICEEOT.2016.7754888.
- [64] R. Kumari, T. R. Chelliah, and K. Desingu, "Development Trends and Future Prospects of Control Systems Serving to Hydropower Plant," in *2018 IEEE International Conference on Power Electronics, Drives and Energy Systems (PEDES)*, 2018, pp. 1–6. DOI: 10.1109/PEDES.2018.8707794.
- [65] Y. Kazantsev, G. Glazyrin, S. Shayuk, D. Tanfilyeva, O. Tanfilyev, and V. Fyodorova, "Hydro Unit Active Power Controller Minimizing Water Hammer Effect," in *2020 Ural Smart Energy Conference (USEC)*, 2020, pp. 47–50. DOI: 10.1109/USEC50097.2020.9281252.
- [66] D. Jones and S. Mansoor, "Predictive feedforward control for a hydroelectric plant," *IEEE Transactions on Control Systems Technology*, vol. 12, pp. 956–965, 2004. DOI: 10.1109/TCST.2004.833405.
- [67] Z. Xiao, S. Meng, N. Lu, and O. P. Malik, "One-Step-Ahead Predictive Control for Hydroturbine Governor," *Mathematical Problems in Engineering*, pp. 1–10, 2015. DOI: 10.1155/2015/382954.
- [68] T. I. Reigstad and K. Uhlen, "Optimized Control of Variable Speed Hydropower for Provision of Fast Frequency Reserves," *Electric Power Systems Research*, vol. 189, pp. 1–10, 2020, ISSN: 0378-7796. DOI: 10.1016/j.epsr.2020.106668.
- [69] T. I. Reigstad and K. Uhlen, "Variable Speed Hydropower Conversion and Control," *IEEE Transactions on Energy Conversion*, vol. 35, pp. 386–393, 2020. DOI: 10.1109/TEC.2019.2943233.

- [70] T. I. Reigstad and K. Uhlen, “Nonlinear model predictive control of variable speed hydropower for provision of fast frequency reserves,” *Electric Power Systems Research*, vol. 194, pp. 1–10, 2021, ISSN: 0378-7796. DOI: 10.1016/j.epsr.2021.107067.
- [71] “IEEE Recommended Practice for Preparation of Equipment Specifications for Speed-Governing of Hydraulic Turbines Intended to Drive Electric Generators,” *IEEE Std 125-2007 (Revision of IEEE Std 125-1988)*, pp. 1–55, 2007. DOI: 10.1109/IEEESTD.2007.4383553.
- [72] “IEEE Guide for Control of Hydroelectric Power Plants,” *IEEE Std 1010-2006 (Revision of IEEE Std 1010-1987)*, pp. 1–81, 2006. DOI: 10.1109/IEEESTD.2006.226661.
- [73] “IEEE Guide for Control of Small Hydroelectric Power Plants,” *IEEE Std 1020-1988*, pp. 1–36, 1988. DOI: 10.1109/IEEESTD.1988.81616.
- [74] “IEEE Guide for the Rehabilitation of Hydroelectric Power Plants,” *IEEE Std 1147-2005 (Revision of IEEE Std 1147-1991)*, pp. 1–63, 2006. DOI: 10.1109/IEEESTD.2006.99379.
- [75] “IEEE Guide for the Application of Turbine Governing Systems for Hydroelectric Generating Units,” *IEEE Std 1207-2011 (Revision to IEEE Std 1207-2004)*, pp. 1–139, 2011.
- [76] “IEEE Guide for the Commissioning of Electrical Systems in Hydroelectric Power Plants,” *IEEE Std 1248-2020 (Revision of IEEE Std 1248-1998)*, pp. 1–155, 2020. DOI: 10.1109/IEEESTD.2020.9086954.
- [77] “IEEE Guide for Computer-Based Control for Hydroelectric Power Plant Automation,” *IEEE Std 1249-1996*, pp. 1–72, 1997. DOI: 10.1109/IEEESTD.1997.82358.
- [78] K. Sopian and J. Razak, “Pico hydro: Clean power from small streams,” in *3rd WSEAS Int. Conf. on RENEWABLE ENERGY SOURCES*, 2009, pp. 414–419.
- [79] O. Paish, “Small hydro power: technology and current status,” *Renewable and Sustainable Energy Reviews*, vol. 6, pp. 537–556, 2002, ISSN: 1364-0321. DOI: 10.1016/S1364-0321(02)00006-0.
- [80] K. Alexander and E. Giddens, “Microhydro: Cost-effective, modular systems for low heads,” *Renewable Energy*, vol. 33, pp. 1379–1391, 2008, ISSN: 0960-1481. DOI: 10.1016/j.renene.2007.06.026.
- [81] T. Hoq, U. A. Nawshad, N. Islam, K. Syfullah, and R. Rahman, “Micro Hydro Power: Promising Solution for Off-grid Renewable Energy Source,” *International Journal of Scientific and Engineering Research*, vol. 2, pp. 1–155, 2011, ISSN: 2229-5518.

- [82] I. Hussein and N. Raman, "Reconnaissance studies of micro hydro potential in Malaysia," in *Proceedings of the International Conference on Energy and Sustainable Development: Issues and Strategies (ESD 2010)*, 2010, pp. 1–10.
- [83] J. Kueny, "Objectives for Small Hydro technology," Institut National Polytechnique De Grenoble Ecole Nationale Supérieure D'hydraulique Et De Mécanique De Grenoble, Tech. Rep., 2013, p. 35.
- [84] S. Khennas and A. Barnett, "BEST PRACTICES FOR SUSTAINABLE DEVELOPMENT OF MICRO HYDRO POWER IN DEVELOPING COUNTRIES," ITDG final synthesis report contract R7215, Tech. Rep., 2000, p. 119.
- [85] E. S. H. Association, "Guide on how to develop a small hydropower plant, 2004 | Guideline book," ESHA, Tech. Rep., 2004, p. 145.
- [86] S. Zongshu, Z. Chengang, and F. Wenyuan, "Water-hammer pressure compensation in turbine regulating systems," *Water Power and Dam Construction*, vol. 9, 1986.
- [87] D. G. Ramey and J. W. Skooglund, "Detailed Hydrogovernor Representation for System Stability Studies," *IEEE Transactions on Power Apparatus and Systems*, vol. PAS-89, 1970. DOI: 10.1109/TPAS.1970.292676.
- [88] C. Vournas and A. Zaharakis, "Hydro turbine transfer functions with hydraulic coupling," *IEEE Transactions on Energy Conversion*, vol. 8, pp. 527–532, 1993. DOI: 10.1109/60.257069.
- [89] L. Hannett, J. Feltes, B. Fardanesh, and W. Crean, "Modeling and control tuning of a hydro station with units sharing a common penstock section," *IEEE Transactions on Power Systems*, vol. 14, pp. 1407–1414, 1999. DOI: 10.1109/59.801904.
- [90] C. Vournas, "Second order hydraulic turbine models for multimachine stability studies," *IEEE Transactions on Energy Conversion*, vol. 5, pp. 239–244, 1990. DOI: 10.1109/60.107216.
- [91] C. K. Sanathanan, "Accurate Low Order Model for Hydraulic Turbine-Penstock," *IEEE Transactions on Energy Conversion*, vol. EC-2, pp. 196–200, 1987. DOI: 10.1109/TEC.1987.4765829.
- [92] C. Sanathanan, "A frequency domain method for tuning hydro governors," *IEEE Transactions on Energy Conversion*, vol. 3, pp. 14–17, 1988. DOI: 10.1109/60.4193.
- [93] M. Özdemir and A. Orhan, "A new approach to the development of a nonlinear model for micro-Pelton turbines," *Turkish Journal of Electrical Engineering and Computer Sciences*, vol. 23, pp. 1272–1283, 2015. DOI: doi:10.3906/elk-1303-72.

- [94] C. S. Kaunda, C. Z. Kimambo, and T. K. Nielsen, “A technical discussion on microhydro-power technology and its turbines,” *Renewable and Sustainable Energy Reviews*, vol. 35, pp. 1272–1283, 2014. DOI: 10.1016/j.rser.2014.04.035.
- [95] S. Boyd and L. Vandenberghe, *Convex Optimization*. Cambridge University Press, 2004.
- [96] J. Nocedal and S. J. Wright, *Numerical Optimization*, 2nd ed. Berlin, New York: Springer-Verlag, 2006.
- [97] C. Hildreth, “A quadratic programming procedure,” *Naval Research Logistics Quarterly*, vol. 4, pp. 79–85, 1957. DOI: 10.1002/nav.3800040113.
- [98] D. Jones, S. Mansoor, F. Aris, G. Jones, D. Bradley, and D. King, “A standard method for specifying the response of hydroelectric plant in frequency-control mode,” *Electric Power Systems Research*, vol. 68, pp. 19–32, 2004, ISSN: 0378-7796. DOI: 10.1016/S0378-7796(03)00152-4.

## Publications

- [Pub1] M. Beus and H. Pandžić, “Application of an adaptive model predictive control algorithm on the pelton turbine governor control,” *IET Renewable Power Generation*, vol. 14, pp. 1720–1727, Apr. 2020, ISSN: 1752-1416. DOI: 10.1049/iet-rpg.2019.1291.
- [Pub2] M. Beus and H. Pandžić, “Practical Implementation of a Hydro Power Unit Active Power Regulation Based on an MPC Algorithm,” *IEEE Transactions on Energy Conversion*, pp. 1–1, Jul. 2021, ISSN: 1558-0059. DOI: 10.1109/TEC.2021.3094059.
- [Pub3] M. Beus, F. Banis, H. Pandžić, and N. Poulsen, “Three-level hierarchical microgrid control - model development and laboratory implementation,” *Electric Power System Research*, vol. 189, Dec. 2020, ISSN: 0378-7796. DOI: 10.1016/j.epsr.2020.106758.
- [Pub4] M. Beus and H. Pandžić, “Application of Model Predictive Control Algorithm on a Hydro Turbine Governor Control,” in *2018 Power Systems Computation Conference (PSCC)*, IEEE, Jun. 2018, pp. 1–7. DOI: 10.23919/PSCC.2018.8442594.



### **Publication 1**

M. Beus and H. Pandžić, “Application of an adaptive model predictive control algorithm on the pelton turbine governor control,” *IET Renewable Power Generation*, vol. 14, pp. 1720–1727, Apr. 2020, ISSN: 1752-1416. DOI: 10.1049/iet-rpg.2019.1291

# Application of an adaptive model predictive control algorithm on the Pelton turbine governor control

Mateo Beus<sup>1</sup> ✉, Hrvoje Pandžić<sup>1</sup>

<sup>1</sup>Department of Energy and Power Systems, University of Zagreb, Faculty of Electrical Engineering and Computing, Unska 3, Zagreb, Croatia

✉ E-mail: mateo.beus@fer.hr

ISSN 1752-1416

Received on 5th November 2019

Revised 17th January 2020

Accepted on 1st April 2020

E-First on 9th June 2020

doi: 10.1049/iet-rpg.2019.1291

www.ietdl.org

**Abstract:** Traditionally, hydro turbine governor applications mainly rely on classical proportional–integral–derivative controllers. A classical controller can perform optimally only at the operating point chosen during the controller design. Since hydro power plants are highly non-linear systems alternative control approaches based on adaptive parameters are needed. Historically, due to the limited computation capabilities of microprocessors and programmable logic controllers (PLCs) used in hydro turbine governors, adaptive control schemes were not frequently applied. However, the latest generation of microprocessors and PLCs facilitate the application of adaptive control scheme based on predictive control algorithm for plants with faster dynamic behaviour. In that regard, this study introduces an adaptive controller based on model predictive control (MPC) algorithm developed and applied to a non-linear simulation model of a laboratory hydro power plant. The applied MPC algorithm is based on a linear prediction model whose parameters are identified offline for different operating points across the plant's operating range. The adaptive control scheme updates the prediction model parameters depending on the current operating point. Furthermore, the predictive control algorithm applied in this study is set up as a quadratic programming (QP) optimisation problem that is solved online using a QP solver in a form of Hildreth's algorithm.

## 1 Introduction

Classical proportional–integral–derivative (PID) are the most commonly used controllers in turbine governor applications with all types of hydro turbines [1, 2]. The main reason for this is their robustness and straightforward implementation. However, severe weakness of classical controllers with fixed parameters is that their design is based on linearised models, while the simulation is usually performed on a non-linear plant model.

Since hydro power plants are highly non-linear systems, classical controllers with fixed parameters can perform optimally only at the operating point selected during the controller design. Therefore, researchers have introduced a number of methods for improving hydro power plant control characteristics across their operating range by adapting the controller parameters according to the current operating point. For instance, Orelind *et al.* [3] demonstrated a potential of a gain-scheduled controller for controlling Francis turbines. The developed controller selects the parameters of a PID compensator as a function of a guide vane angle. On the other hand, Simani *et al.* [4] introduced an advanced control strategy for a typical hydro electric dynamic process. The proposed methodology relies on an adaptive control design by means of an on-line identification of the system model. In [5], the authors proposed a robust PID controller design for an electro-hydraulic governor of a hydraulic unit based on sensitivity margin specification. The authors concluded that due to the non-minimum phase behaviour of hydraulic power unit the sensitivity margin is a more adequate measure and performance indicator than commonly used gain and phase margins. Additionally, in [6] the authors described procedure for designing classical speed and active power controller of hydro turbine unit using a pole placement method. As a representative of heuristic methods, Gonggui *et al.* [7] introduced an improved fuzzy particle swarm optimisation algorithm to calculate optimal turbine governor PID parameters under frequency and load disturbance conditions. Furthermore, in [8] the authors presented a genetic algorithm based fuzzy reduced-order sliding mode controller to govern the hydro turbine speed for a hydro power plant with an upstream surge tank. In [9], the authors described a one-step ahead predictive control based on on-line

trained neural networks for hydro turbine governor with variations in gate position.

Generally, each hydro turbine governor consists of two automatic controllers, which are known as the speed controller and the frequency/load controller [10]. The speed controller is active during the start-up sequence, i.e. when hydro power plant is being synchronised to the grid, while the load/frequency controller takes over once the hydro power plant is synchronised to the grid.

Being highly non-linear systems, efficient operation of hydro power plants requires control methods that take into account hard constraints and multivariable effects. These requirements call for a MPC algorithm since this control method naturally deals with hard constraints on control variables [11, 12]. In that regard, it is reasonable to assume that MPC as a control method can be effectively applied in hydro turbine governor applications, which is the main goal of this paper. The main contribution is the development of an adaptive frequency/load controller based on an MPC algorithm and applied to a non-linear simulation model of a small-scale hydro power plant located in the Smart Grid Lab (SGLab) at the University of Zagreb, Faculty of Electrical Engineering and Computing.

The paper is organised as follows. Review of the publications on the application of MPC in power plants with an emphasis on hydro power plants is performed in Section 2. An adaptive MPC algorithm formulation is presented in Section 3, while the developed plant model is explained in Section 4. The simulation results and discussions are provided in Section 5. The paper is concluded in Section 6.

## 2 Review of MPC applications in power plants

MPC as a control method has been widely used for control of industrial and power plants with slow dynamics such as heating, ventilation and air conditioning systems or coal-fired thermal power plants. Historically, the main reason for this can be found in the limited computation capabilities of microprocessors and PLCs used in governors. However, the latest generation of microprocessors and PLCs facilitates the application of MPC as a control method for plants with faster dynamic behaviour. Fig. 1

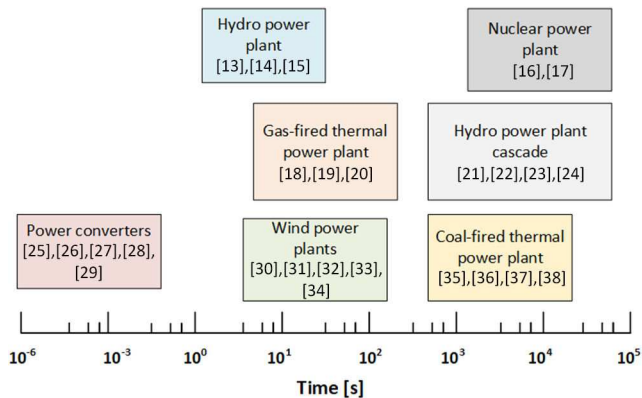

**Fig. 1** Visualisation of time constants for different power plants

illustrates approximate operating time scales for different power plants and existing literature regarding the MPC applications.

A fair amount of the literature is available on the application of MPC algorithms on wind, coal/gas-fired thermal power plants, power converters and even nuclear power plants. However, the majority of the literature in this topic is focused on control of a hydro power plant cascade.

A finite control set-MPC, which is a form of explicit MPC algorithm, has attracted wide attention in control of power converters [25–27]. This is primarily because power converters operate in the time scale of  $\mu\text{s}$  and it is difficult to employ on-line optimisation procedures at that time scale. In [28], the authors presented an MPC strategy for inverters in renewable power generation applications. In the islanded mode, the main goal of MPC strategy applied to inverters is to provide stable voltage conditions for the loads. In the grid-connected mode, the main goal of MPC strategy applied to the inverters is to fulfil flexible active and reactive power regulation. In [29], the authors provided a comprehensive survey on different control strategies for power converter devices interfaced distributed generation units.

An MPC controller for double-fed induction generators (DFIGs), which are widely used in wind power plants, is proposed in [30]. A linearised state-space DFIG model is used as the MPC controller's internal prediction model. Additionally, Henriksen *et al.* [31] considered an MPC-based control approach for a wind turbine controller, in contrast, Qi *et al.* [32] introduced a supervisory MPC control method for optimal management and operation of a hybrid standalone wind-solar plant. Supervisory MPC control scheme calculates active power set points for wind and a solar power plant at each sampling instant. These set points are then passed on to two local plant level controllers responsible to drive the plants to the requested power set points. In [33], an MPC control algorithm based on linear parameter-varying models subject to input/output constraints is applied to control a wind turbine. The effectiveness of this approach is demonstrated on a utility scale wind turbine over the entire operating envelope. In addition, the authors in [34] investigated the application of MPC on preserving voltage stability of a hybrid wind–diesel system operating in islanded mode using reactive power control.

Applicability of an industrial MPC to thermal power plants is demonstrated in [35], where a dynamic matrix control is applied as an MPC algorithm on a detailed thermal power plant simulator used for tuning the controllers. The presented results indicate that MPC as a control method has great potential in terms of improved flexibility and economical savings. Furthermore, MPC is used in [18] as a control method for improving thermal efficiency and load/frequency control capabilities of a gas turbine power plant. Application of MPC also improves frequency and load following capabilities. In [16], a state-space MPC method is applied to the control of the core power in a pressurised water reactor. Additional applications of MPC to thermal power plant processes can be found in [36–38] for coal-fired power plants, [19, 20] for gas-fired power plants, and in [17] for nuclear power plants.

In [13], a predictive feedforward control is used to govern a hydro power plant to its active power set point while operating in the load control mode (LCM)/frequency control mode (FCM). The

results show that this type of control improves active power tracking in the LCM/FCM. However, the authors indicate that this approach results in more aggressive movements of the guide vane which can cause a mechanical wear. An MPC algorithm is applied to a multiple-input–multiple-output (MIMO) model of a pumped hydro power plant in [14]. The proposed algorithm improves the plant's response as compared to the classical PI controller. Additional advantage of this approach is that the applied MPC algorithm is based on a MIMO plant prediction model that takes into account hydraulic coupling effect between the turbines connected to a common supply tunnel. Since hydraulic coupling effect has negative impact on the stability margin in a closed loop, the proposed approach extends the stability margin. In [15], a generalised predictive control algorithm is applied to a linearised model of a high-head hydro power plant's unit. As in the previous case, the predictive controller response is competitive with the classical PID response. However, the MPC algorithms in both [14, 15] used the same linear model as the controller's internal prediction model and for plant simulation purposes as well.

A number of MPC-based approaches are available for controlling a cascade of hydro power plants as well. For instance, a supervisory MPC scheme for controlling a cascade of five hydro power plants is introduced in [21]. Goal of the proposed MPC scheme is to minimise water-level deviations by manipulating turbine discharges in a coordinated fashion. Maestre *et al.* [22] compared five distributed MPC (DMPC) schemes on a hydro power plant cascade model using a 24-hour power tracking scenario. In addition, a hierarchical MPC scheme used for control of a hydro power plant cascade is introduced in [23]. The proposed hierarchical MPC scheme consists of two layers. The upper control layer optimises power profiles during a one-day horizon with a 30-minute step, while the lower control level optimises power profiles within a 30-minute horizon and a 1-minute step. An MPC scheme is applied in [24] on a hydro power plant cascade to schedule available hydro power with a goal of counteracting the variability of wind generation and minimising environmental impact of hydro power plants caused by water level variations.

Considering the reviewed papers, some preliminary work on applying MPC algorithms to turbine governor control already exists. However, the main drawback of these models is that the proposed MPC algorithms are based on fixed-parameter linear prediction models and linear plant simulation models. The main contribution of this paper is to extend the existing state-of-the-art by introducing an MPC algorithm based on the adaptive linear prediction model. Prediction model parameters in the proposed model are updated depending on the needle opening at the end of the penstock and active power production. Additional contribution of this paper is that the proposed control algorithm is validated using a non-linear simulation model of the plant.

### 3 Formulation of adaptive MPC algorithm

MPC algorithm as a control strategy includes predictive model of a plant within the controller to calculate the future output of the plant by adjusting the control signal values. Response of the plant is predicted at each sampling instant for a specified number of samples  $N$  into the future by calculating the future control signal sequence for a specific number of samples  $N_c$ . In this setting,  $N$  is known as the prediction horizon and  $N_c$  is the control signal horizon.  $N_c$  determines the number of parameters used to capture the future control sequence. The control sequence at each sampling instant is based on a solution of an optimisation problem whose objective function is defined based on the response specifications of the plant and the type of optimisation problem. Although at each sampling instant the optimisation problem is solved and control sequence for the entire control horizon is calculated, only the first value of the control sequence is implemented because at the next sampling instant the plant measurements are updated and control sequence calculation is repeated based on the receding horizon approach. An interested reader can find a detailed description of MPC formulation in [11, 12].

The structure of a QP optimisation problem used to form the control algorithm based on MPC is introduced in the following subsections.

### 3.1 Objective function

$$J = [R_s - P]^T W_y [R_s - P] + \Delta U^T W_u \Delta U, \quad (1)$$

where  $R_s$  is a reference trajectory expressed as:

$$R_s = [r(k+1)r(k+2)r(k+3)\dots r(k+N)]. \quad (2)$$

The first term in quadratic objective function (1) denotes the errors between the reference trajectory  $R_s$  and the predicted plant output  $P$ , while the second term represents the control effort. In this regard,  $W_y$  and  $W_u$  can be considered as tuning parameters, where  $W_y$  penalises the predicted plant output deviations from the reference trajectory, while  $W_u$  penalises the change of the control signal value.

### 3.2 Model of the plant

Structure of a linear discrete-time model identified for different operating points is:

$$\frac{P(z)}{U(z)} = G(z) = \frac{c_3 z + c_4}{z^2 + c_1 z + c_2}, \quad (3)$$

where coefficients  $c_1$ ,  $c_2$ ,  $c_3$  and  $c_4$  are identified from the hydro power plant measurements at different operating points, as described in Section 4. To avoid using an observer, variables in the state-variable vector are defined based on the availability of direct measurements, i.e. active power production and needle opening. This implies that linear state-space model formulation is used as a prediction model in this MPC algorithm. Therefore, to obtain an augmented state-space formulation, the discrete-time model expressed in (3) is reformulated into a difference equation that relates the input to the output:

$$P(k+1) + c_1 P(k) + c_2 P(k-1) = c_3 u(k) + c_4 u(k-1), \quad (4)$$

where  $P(k)$  is active power generation of the hydro power plant at sampling instant  $k$ , while  $u(k)$  is a control signal/needle opening that controls water flow into the turbine. By defining the state-variable vector as:

$$x_m(k) = [P(k) P(k-1) u(k-1)]^T, \quad (5)$$

and combining it with (4), we obtain a state-space model formulation:

$$\begin{bmatrix} P(k+1) \\ P(k) \\ u(k) \end{bmatrix} = \begin{bmatrix} -c_1 & -c_2 & c_4 \\ 1 & 0 & 0 \\ 0 & 0 & 0 \end{bmatrix} \begin{bmatrix} P(k) \\ P(k-1) \\ u(k-1) \end{bmatrix} + \begin{bmatrix} c_3 \\ 0 \\ 1 \end{bmatrix} u(k), \quad (6)$$

$$P(k) = [1 \ 0 \ 0] x_m(k). \quad (7)$$

Finally, the augmented state-space prediction model formulation used in the MPC algorithm is obtained by extending the state-variable vector defined in (5) and combining it with (6) and (7):

$$x(k) = [\Delta P(k) \ \Delta P(k-1) \ \Delta u(k-1) \ P(k)]^T, \quad (8)$$

$$\begin{bmatrix} \Delta P(k+1) \\ \Delta P(k) \\ \Delta u(k) \\ P(k+1) \end{bmatrix} = \begin{bmatrix} -c_1 & -c_2 & c_4 & 0 \\ 1 & 0 & 0 & 0 \\ 0 & 0 & 0 & 0 \\ -c_1 & -c_2 & c_4 & 1 \end{bmatrix} \begin{bmatrix} \Delta P(k) \\ \Delta P(k-1) \\ \Delta u(k-1) \\ P(k) \end{bmatrix} + \begin{bmatrix} c_3 \\ 0 \\ 1 \\ c_3 \end{bmatrix} \Delta u(k), \quad (9)$$

$$P(k) = [0 \ 0 \ 0 \ 1] x(k), \quad (10)$$

where  $\Delta P(k)$  and  $\Delta u(k)$  are expressed as:

$$\Delta P(k) = P(k) - P(k-1), \quad (11)$$

$$\Delta u(k) = u(k) - u(k-1). \quad (12)$$

Based on the state-space formulation (9) and (10), the future hydro power plant output can be calculated sequentially using the following compact matrix form:

$$P = Fx(k) + \phi \Delta u, \quad (13)$$

where  $P$  and  $\Delta U$  are expressed as:

$$P = [P(k+1) P(k+2) P(k+3) \dots P(k+N)]^T, \quad (14)$$

$$\Delta U = [\Delta u(k) \ \Delta u(k+1) \ \Delta u(k+2) \dots \Delta u(k+N_c-1)]^T. \quad (15)$$

A detailed description of matrices  $F$  and  $\phi$  can be found in [11, 12].

### 3.3 Constraints formulation

One of the key advantages of MPC as a control strategy is that it includes different types of constraints on control and output signals during the controller design phase. In this case, only the constraints for the control signal are included within the MPC algorithm. The constraints for the control signal of amplitude  $u$  and rate of the control signal  $\Delta u$  are expressed as:

$$U^{\min} \leq U \leq U^{\max}, \quad (16)$$

$$-\Delta U^{\min} \leq \Delta U \leq \Delta U^{\max}. \quad (17)$$

where  $U^{\min}$ ,  $U^{\max}$ ,  $\Delta U^{\min}$  and  $\Delta U^{\max}$  are column vectors with  $N_c$  elements of  $u^{\min}$ ,  $u^{\max}$ ,  $\Delta u^{\min}$  and  $\Delta u^{\max}$ , respectively. These constraints are expressed in the compact matrix form for the entire control horizon as:

$$M_c \Delta U \leq c, \quad (18)$$

where  $M_c^{[4N_c \times N_c]}$  and  $c^{[4N_c \times 1]}$  are defined as follows:

$$M_c = \begin{bmatrix} I \\ -I \\ L \\ -L \end{bmatrix}, \quad c = \begin{bmatrix} l(\Delta u^{\max}) \\ l(\Delta u^{\min}) \\ l(u^{\max} - u(k-1)) \\ l(u^{\min} + u(k-1)) \end{bmatrix}, \quad I = \begin{bmatrix} 1 \\ \vdots \\ 1 \end{bmatrix}.$$

The dimension of vector  $l$  is  $[N_c \times 1]$ . The inclusion of the above control signal constraints is important primarily due to safety reasons since a fixed-rate at which a needle can change its opening mitigates pressure variations in the penstock that can destroy or severely damage the hydro power plant. Amplitude constraints for the control signal are imposed due to physical limitations of the actuator.

### 3.4 Hildreth algorithm

The objective function (1) and the constraints (9), (10) and (18) form a typical QP optimisation problem. Generally, practical implementation of an MPC algorithm is limited by the governor's hardware inability of dealing with computation requirements necessary for solving the optimisation problem online. Therefore, for real-time applications it is essential to choose a QP solver that is robust enough to provide close-to-optimal solution in the situation when conflicts of constraints arise. Another important criteria for choosing appropriate QP solver are computation requirements and simplicity of implementing the solver on a PLC. In this paper, Hildreth's QP algorithm is used for solving the QP optimisation problem online. This algorithm does not require

$$\mathbf{K} = \mathbf{c} + \mathbf{M}_c \mathbf{E}^{-1} \mathbf{F}. \quad (23)$$

Finally, optimal control sequence is then calculated as:

$$\Delta \mathbf{U} = -\mathbf{E}^{-1}(\mathbf{F} + \mathbf{M}_c^T \boldsymbol{\lambda}). \quad (24)$$

Mechanics of the Hildreth's algorithm are explained in Steps 4–5 in Fig. 2. The algorithm calculates the solution in two steps. In the first step the algorithm calculates the unconstrained solution. If the unconstrained solution satisfies the constraints, the solution is applied to the plant. However, if any constraint is violated, then a constrained QP is solved using the method formulated in (20)–(24). If the maximum number of iterations of the Hildreth's algorithm is reached and the optimal solution is still not found, the unconstrained solution from Step 4, adjusted to the unsatisfied constraints, is applied to the plant.

### 3.5 Adaptive MPC

Adaptive MPC algorithm is an extension of the basic MPC explained in the previous subsection. The main difference between the former and the latter is that in case of the adaptive MPC, controller's internal prediction model parameters are updated depending on the current operating point. This enables approximation of a highly non-linear system, such as hydro power plant, with a number of linear models. These models describe well the behaviour of the plant in the narrow area around the operating point for which they are identified. The internal discrete-time linear prediction model coefficients  $c_1$ – $c_4$  are identified for different operating points from the open-loop step response measurements of a hydro power plant. Flowchart of the adaptive MPC algorithm is shown in Fig. 2. The entire procedure consists of seven major steps. Step 1 is conducted offline, while Steps 2–7 are conducted online. In Step 1, the controller's look-up table is formed with internal prediction model coefficients for different operating points. This step also initialises controller's input and output signal values. These values are used by the internal prediction model and updated with the values from the previous iteration at the beginning of each online iteration. Online computation procedure starts in Step 2. First, current active power and needle opening measurements are updated. Based on these measurements, the algorithm updates the internal prediction model coefficients from the appropriate row in the look-up table formed in Step 1. In Step 3, the Hildreth's algorithm is called to solve the QP optimisation problem. After calculation of the optimal control sequence in Step 6, only the first control sequence value is applied to the plant. In Step 7, the controller's input and output signal values from current iteration are saved. After completion of Step 7, the entire computation procedure with Steps 2–7 is repeated.

## 4 Hydro power plant model

Non-linear simulation model of the laboratory hydro power plant is derived to investigate the behaviour of the A-MPC algorithm. In the following subsections, a detailed description of the laboratory hydro power plant as well as the simulation setup is provided.

### 4.1 Plant description

To validate the A-MPC algorithm, the load/frequency controller is developed and tested on the non-linear simulation model of the hydro power plant available at the SGLab at the University of Zagreb, Faculty of Electrical Engineering and Computing [41]. A schematic diagram of the analysed hydro power plant is represented in Fig. 3, where numbers 1–9 are used to represent the main plant's components. Hydraulic unit (number 1) is used to produce the hydraulic oil pressure necessary to control the hydraulic cylinders that serve as actuators for the needle and the deflector. The deflector (number 2) is used to deflect water jet from the turbine runner. Needle valve (number 3) is used to adjust the flow through the nozzle to the turbine runner. The water jet from the nozzle hits the Pelton turbine (number 4) runner blades and causes a tangential force on the runner due to change of

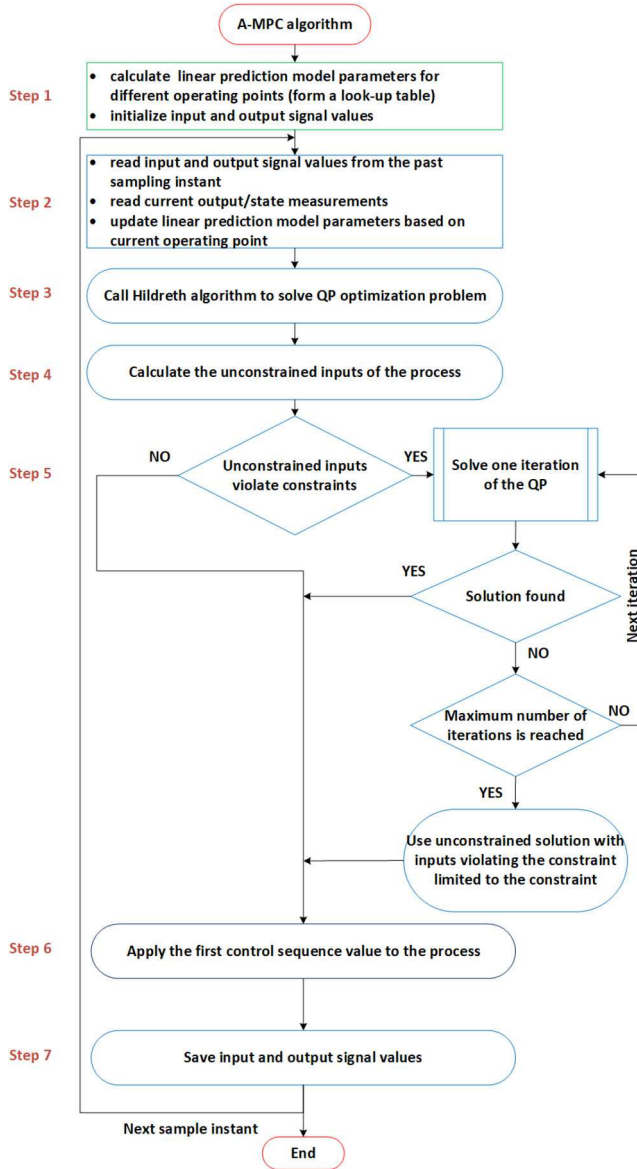

Fig. 2 Adaptive MPC algorithm

matrix inversion because it is based on an element-by-element search [39]. This implies lower computation demands. In addition, in case of a conflict of constraints, the algorithm gives a near-optimal solution. In order to apply Hildreth's algorithm, the previously introduced QP problem is reformulated and expressed as:

$$\mathbf{J}_* = \frac{1}{2} \Delta \mathbf{U}^T \mathbf{E} \Delta \mathbf{U} + \Delta \mathbf{U}^T \mathbf{F}, \quad (19)$$

subject to (9), (10) and (18). An interested readers can find the formulation of matrices  $\mathbf{E}$  and  $\mathbf{F}$  in [39]. To find the Lagrange multipliers, which are the solution of Hildreth's algorithm, an element-by-element search method is applied. This method can be expressed as [39, 40]:

$$\lambda_i^{m+1} = \max(0, w_i^{m+1}), \quad (20)$$

$$w_i^{m+1} = -\frac{1}{h_{ii}} \left[ k_i + \sum_{j=1}^{i-1} h_{ij} \lambda_j^{m+1} + \sum_{j=i+1}^n h_{ij} \lambda_j^m \right], \quad (21)$$

where  $h_{ij}$  and  $k_i$  are defined as  $ij$ th and  $i$ th elements of matrix  $\mathbf{H}$  and vector  $\mathbf{K}$ , respectively. Matrix  $\mathbf{H}$  and vector  $\mathbf{K}$  are expressed as:

$$\mathbf{H} = \mathbf{M}_c \mathbf{E}^{-1} \mathbf{M}_c^T, \quad (22)$$

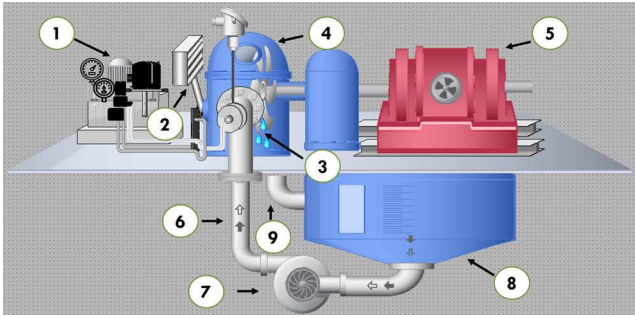

Fig. 3 Schematic diagram of the hydro power plant in the SGLab

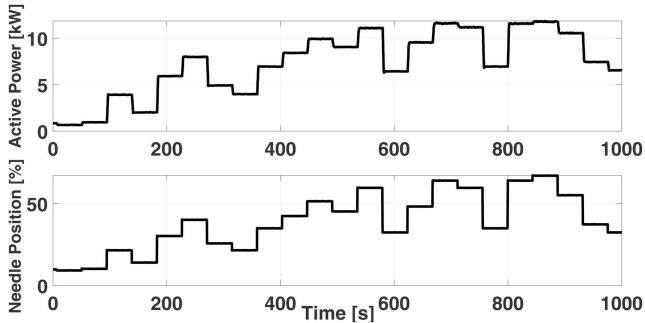

Fig. 4 Open-loop hydro power plant measurements – non-linear model identification

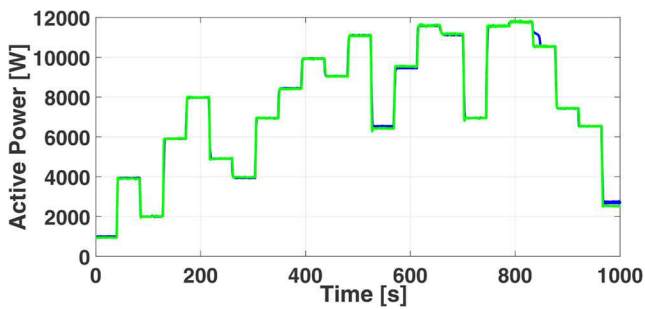

Fig. 5 Measured and simulated non-linear model output

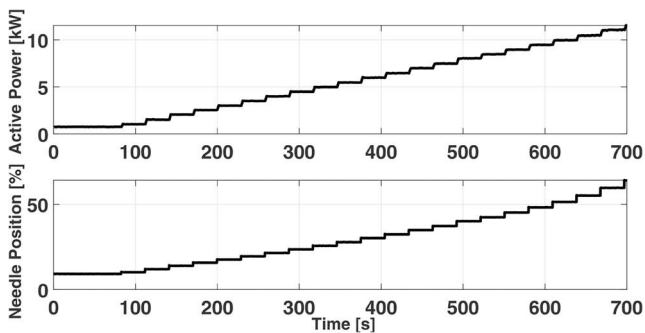

Fig. 6 Open-loop hydro power plant measurements – linear model identification

momentum. Turbine runner blades of a Pelton turbine have a bucket shape and when the jet hits the bucket a ridge splits the jet into half, so that each half is turned and deflected back through an angle close to  $180^\circ$  to maximise power production [42]. Another important characteristic of a Pelton turbine is that the turbine is not submerged in water. This implies that the pressure across the runner is constant at atmospheric pressure. Number 5 represents the synchronous generator, while number 6 represents the penstock. Number 7 represents water pump used to pump the water from the water reservoir to the turbine represented by number 8. The water pump can produce pressure levels at the end of the penstock from 5.5 to 6.4 bar. This enables simulating a net head

from around 55 to 64 m. Finally, number 9 represents a pipe used to bring the water back to the water reservoir.

The basic parameters of the analysed plant are as follows: rated power is 11.8 kW, rated speed 1000 rpm, rated flow  $0.027 \text{ m}^3 \text{ s}^{-1}$ , net head is 64 m, length of the penstock is 5 m and penstock diameter 0.6 m. A more detailed description of the plant can be found in [43].

#### 4.2 Non-linear plant simulation model

In this paper, a non-linear autoregressive exogenous (ARX) model is used for the hydro power plant simulation, while linear discrete time transfer-function models identified for different operating points are transformed into augmented state-space models and used as controller's internal prediction models. Model identification of both the linear and non-linear models is conducted using MATLAB/System Identification toolbox.

Non-linear ARX model is an extension of the linear ARX model and has the following structure [44]:

$$y(t) = f(y(t-1), \dots, y(t-n_a), u(t-n_k), \dots, u(t-n_k-n_b+1)), \quad (25)$$

where  $f$  is a non-linear function and input to  $f$  are model regressors. A wavelet network is chosen as a non-linear mapping function in the identification procedure. In addition, in (25)  $n_a$  is defined as the number of past output terms,  $n_b$  is the number of past input terms and  $n_k$  is the delay from the input to the output expressed as the number of samples. In this case, values of  $n_a$ ,  $n_b$  and  $n_k$  are set to 1.

Hydro power plant open-loop measurements are used to identify the non-linear and linear plant models. In both identification procedures, Pelton turbine needle opening serves as an input/control signal, while active power production is an output signal. Fig. 4 shows hydro power plant measurements used for the identification of the non-linear ARX model. Control signal values are randomly generated to capture the plant's dynamic over the entire operating envelope. After conducting the identification, the obtained non-linear ARX model response is compared with the measured response of the plant. The results are shown in Fig. 5, where simulated non-linear ARX model response represented by the blue line fits 95.43% to the measured plant response represented by the green line.

Fig. 6 shows that the step responses around different operating points are used to identify the linear prediction models. Sampling time  $T_s$  used to discretise identified linear plant models is set to 100 ms. The measurements are taken over the entire plant's operating range for a fixed value of the pressure of 6.4 bar at the end of the penstock, which simulates the net head of 64 m. Pressure measurements are given in Fig. 7.

#### 4.3 Simulation setup

A schematic diagram of the MATLAB/Simulink simulation setup used to validate the proposed algorithm is given in Fig. 8. The proposed A-MPC algorithm is used as a load/frequency controller, i.e. the plant is synchronised to the main grid during the simulation. The cases without LCM and with FCM provision of primary reserve are simulated. In the latter case, active power reference trajectory is readjusted depending on the frequency deviation  $\Delta f$  and the droop setting  $D$ .

Criterion  $C_1$  in Table 1 represents the primary response and implies that at least 90% of the demanded step power change is realised within the defined time  $t_{C_1}$  of initiation. Criterion  $C_2$  represents overshoot realised within the defined time  $t_{C_2}$ . Criterion  $C_3$  represents the settling time of the response. This criterion defines that the response should be settled within the defined time  $t_{C_3}$ . Criterion  $C_4$ , which represents the non-minimum phase behaviour, is neglected in this analysis. This is primarily because water inertia effect responsible for non-minimum phase behaviour is barely visible. The main reason for this is very short penstock and the fact that the water pressure at the end of the penstock is regulated by a water pump. Thus, pressure variations are very low

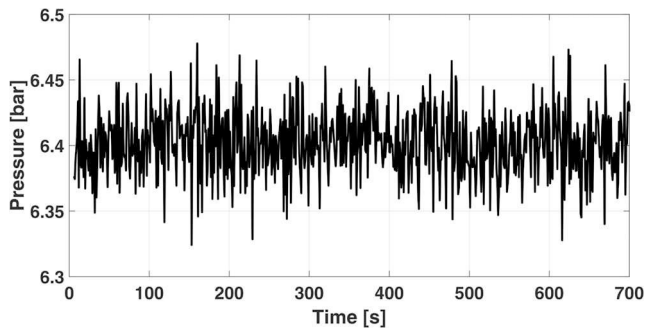

Fig. 7 Pressure measurements

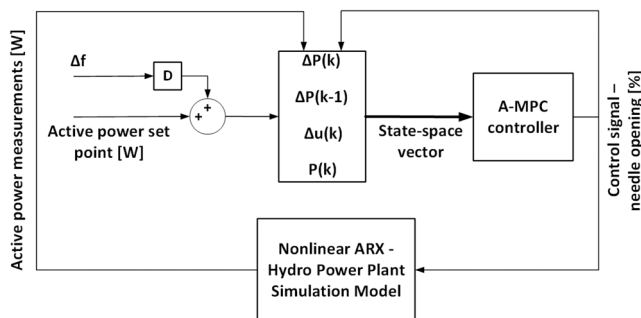

Fig. 8 Schematic diagram of the simulation setup

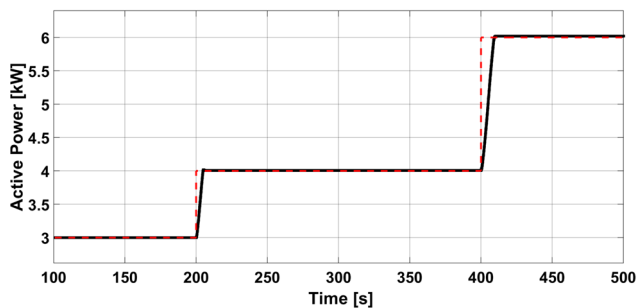

Fig. 9 A-MPC step response – LCM

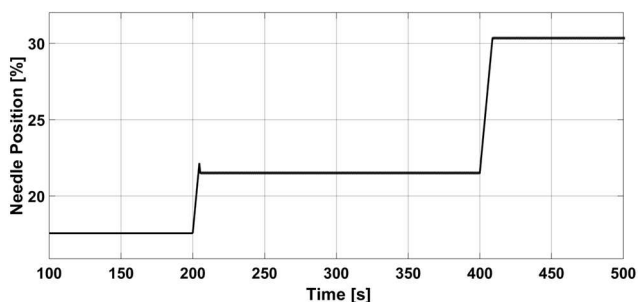

Fig. 10 Needle position – LCM

(approximately  $\pm 0.1$  bar) during the change of the operating point. This effect is evident in Figs. 6 and 7. Table 1 lists specifications for the A-MPC controller design. Overshoot should be under 4%, the plant's response should be settled within 10 s and demanded step power change should be realised within 10 s of initiation.

## 5 Simulation results and discussion

A-MPC controller settings used in both simulation cases are given in Table 2.

### 5.1 Load control mode

A-MPC response in the LCM is shown in Fig. 9. Red dotted line presents the active power set point, while the black line presents the active power response. During the first 200 s, the hydro power

Table 1 Specifications for the control design [45, 46]

Criterion	Specification for a single-unit step response
$C_1$ – rise time	$C_1 \geq 90\%$ at $t_{C_1} = 10$ s
$C_2$ – overshoot	$C_2 \leq 4\%$ and $t_{C_2} \leq 10$ s
$C_3$ – settling time	$t_{C_3} = 10$ s for $C_3 \leq 0.5\%$

Table 2 Controller settings

prediction horizon – $N$	10
control horizon – $N_c$	10
weighting factor – $W_y$	1000
weighting factor – $W_u$	250
maximal control signal amplitude – $u^{\max}$	70%
minimal control signal amplitude – $u^{\min}$	6%
maximal rate of control signal – $\Delta u^{\max}$	0.1%
minimal rate of control signal – $\Delta u^{\min}$	–0.1%

Table 3 A-MPC response for the LCM (LCM) and the FCM.

Criterion	LCM		FCM
	3 kW	4 kW	3 kW
$C_1$	90% at 4.4 s	90% at 8.2 s	90% at 1.3 s
$C_2$	1.7% at 5.2 s	1.1% at 9.4 s	3.4% at 1.8 s
$C_3$	6.5 s	9.7 s	4.2 s

plant operates at 3 kW or 25.42% of the full load. At  $t = 200$  s, a step demand of 1 kW (8.47% of the rated power) is applied to the plant and the operating point is changed to 4 kW or 33.89% of the full load. At  $t = 400$  s, a step demand of 2 kW (16.94% of the rated power) is applied and the operating point is changed to 6 kW. In this mode, droop  $D$  is set to 0%, which means that the hydro power plant ignores frequency disturbances in the grid and strictly follows the turbine governor's active power set point. The quality of the A-MPC response in the LCM is analysed calculating the values  $C_1$ – $C_3$  and comparing them to the response requirements. These values are given in columns under LCM in Table 3. Compared to the response specification criterion for the operating point of 3 kW and a step change of 1 kW, the primary response is 5.6 s faster than the required time  $t_{C_1}$  defined by  $C_1$  criterion. The response overshoot realised within the required time  $t_{C_2}$  is 2.3% lower compared to the value defined by  $C_2$  criterion, while the response settles 3.5 s before the time  $t_{C_3}$  defined by  $C_3$  criterion. On the other hand, for the operating point of 4 kW and a step change of 2 kW, the primary response is 1.8 s faster than the required time  $t_{C_1}$  defined by  $C_1$  criterion. The response overshoot realised within the required time  $t_{C_2}$  is 2.9% lower compared to the value defined by  $C_2$  criterion, while the response settles 0.3 s before the time  $t_{C_3}$  defined by  $C_3$  criterion. Thus, the step response in the LCM with A-MPC controller satisfies the response specifications defined in Table 1.

Additionally, the control signal response given in Fig. 10 shows that the values of the control signal for these operating points corresponds to the control signal values from the hydro power plant open-loop measurements given in Figs. 4 and 6.

### 5.2 Frequency control mode

A-MPC response in the FCM is shown in Fig. 11. Again, the red dotted line denotes the active power set point adjustment, while the black line presents the active power response.

The hydro power plant operates initially at 3 kW or 25.42% of the full load and droop  $D$  is set to 3% which means if the grid frequency decreases by 1%, the hydro power plant will increase its power output by 3% of total rated power to stop further frequency drop. Additionally, if the grid frequency increases by 1%, the hydro power plant will decrease its power output by 3% of total rated power to stop further frequency increase. In Fig. 11, at  $t = 100$  s, a

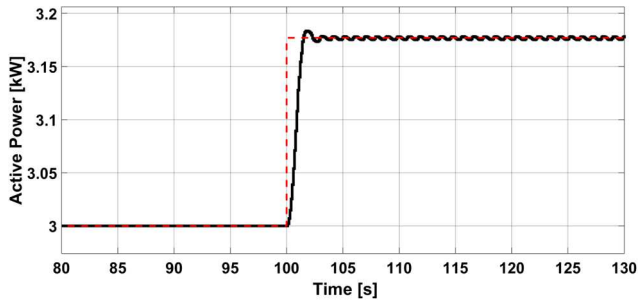

Fig. 11 A-MPC response – FCM

disturbance occurs and the grid frequency is decreased by 0.5% or 0.25 Hz. Since  $D = 3\%$ , the active power set point is increased by 1.5% or 0.177 kW to compensate for this frequency deviation. The quality of the A-MPC response in the FCM is analysed calculating the values  $C_1$ – $C_3$  and comparing them to the response requirements. These values are given in column under FCM in Table 3. Compared to the response specification criterion the primary response is 8.7 s faster than the required time  $t_{C_1}$  defined by  $C_1$  criterion. The response overshoot realised within the required time  $t_{C_2}$  is 3.4% lower compared to the value defined by  $C_2$  criterion, while the response settles 5.8 s before the time  $t_{C_3}$  defined by  $C_3$  criterion. This indicates that the response in the FCM with the A-MPC controller satisfies the response specifications defined in Table 1.

## 6 Conclusion

The main idea of this paper was to investigate the possibility of applying an A-MPC controller as the load/frequency controller in a hydro turbine governor. To validate the proposed MPC algorithm, a non-linear plant model was used for simulation purposes. Two simulation cases were analysed. In the first simulation case, an A-MPC controller response in the LCM was validated, while in the second simulation case an A-MPC controller response in the FCM was validated. Simulation results in both cases show that the A-MPC controller responses are within the required specifications. An additional value of the paper is in demonstration of the practical implementation potential of the formulated A-MPC controller. Since Hildreth's algorithm is used as a QP solver, it is relatively simple to implement the proposed A-MPC controller on an PLC. Therefore, our further research will be focused on practical implementation on the PLC and further validation of the algorithm introduced in this paper.

## 7 Acknowledgment

This work was one of the results of the H2020 ERA Net Smart Grids+ project 'microGRID Positioning - uGRIP' funded in part by the Croatian Environmental Protection and Energy Efficiency Fund.

## 8 References

- [1] Culberg, J., Negnevitsky, M., Kashem, K.A.: 'Hydro turbine governor control: theory, techniques and limitations'. Australasian Universities Power Engineering Conf. (AUPEC 2006), Melbourne, Australia, 2006
- [2] Kishor, N., Saini, R.P., Singh, S.P.: 'A review on hydro power plant models and control', *Renew. Sustain. Energy Rev.*, 2007, **11**, pp. 776–796
- [3] Oreilind, G., Wozniak, L., Medanic, J., et al.: 'Optimal PID gain schedule for hydrogenerators - design and application', *IEEE Trans. Energy Convers.*, 1989, **4**, (3), pp. 300–307
- [4] Simani, S., Alvisi, S., Venturini, M.: 'Study of the time response of a simulated hydroelectric system', *J. Phys., Conf. Series*, 2014, **570**, (5), pp. 1–14
- [5] Husek, P.: 'PID controller design for hydraulic turbine based on sensitivity margin specifications', *Electr. Power Energy Syst.*, 2014, **55**, pp. 460–466
- [6] Strah, B., Kuljaca, O., Vukic, Z.: 'Speed and active power control of hydro turbine unit', *IEEE Trans. Energy Convers.*, 2005, **20**, (2), pp. 424–434
- [7] Gongui, C., Yangwei, D., Yanyan, G., et al.: 'PID parameters optimization research for hydro turbine governor by an improved fuzzy particle swarm optimization algorithm', *The Open Electr. Electron. Eng. J.*, 2016, **10**, pp. 101–117
- [8] Xu, C., Qian, D.: 'Governor design for a hydro power plant with an upstream surge tank by GA-based fuzzy reduced-order sliding mode', *Energies*, 2015, **8**, pp. 13442–13457
- [9] Xiao, Z., Meng, S., Malik, O.P.: 'One-step-ahead predictive control for hydro turbine governor', *Math. Probl. Eng.*, 2015, **2015**, pp. 1–10
- [10] ABB 'Hydro power - Intelligent solutions for hydro governors', 2016
- [11] Maciejowski, J.M.: 'Predictive control: with constraints' (Prentice-Hall, Englewood Cliffs, NJ, 2002)
- [12] Camacho E. F., Bordons, C.: 'Model predictive control' (Springer-Verlag, New York, 1999)
- [13] Jones, D., Mansoor, S.: 'Predictive feedforward control for a hydroelectric plant', *IEEE Transactions on Control System Technology*, 2004, **12**, (6), pp. 921–929
- [14] Munoz Hernandez, G.A., Jones, D.I.: 'MIMO generalized predictive control for a hydroelectric power station', *IEEE Trans. Energy Convers.*, 2006, **21**, (4), pp. 921–929
- [15] Beus, M., Pandzic, H.: 'Application of model predictive control algorithm on a hydro turbine governor control'. 2018 Power Systems Computation Conf. (PSCC), Dublin, Ireland, 2018
- [16] Wang, G., Wu, J., Zeng, B., et al.: 'State-space model predictive control method for core power control in pressurized water reactor nuclear power stations', *Nucl. Eng. Technol.*, 2017, **49**, pp. 134–140
- [17] Liu, X., Jiang, D., Lee, K.Y.: 'Decentralized fuzzy MPC on spatial power control of a large PHWR', *IEEE Trans. Nucl. Sci.*, 2016, **63**, (4), pp. 2343–2351
- [18] Mohamed, O., Wang, J., Khalil, A., et al.: 'Predictive control strategy of a gas turbine for improvement of combined cycle power plant dynamic performance and efficiency', *SpringerPlus*, 2016, **5**, (1), p. 980
- [19] Krishnan, A., Patil, B.V., Gooi, H.B., et al.: 'Predictive control based framework for optimal scheduling of combined cycle gas turbines'. Proc. of the 2016 American Control Conf. (ACC), Boston, USA, 2016
- [20] Nieto-Chaupis, H.: 'Prospects of model predictive control of the drum level at a 225 MW combined cycle power plant'. 2016 IEEE Ecuador Technical Chapters Meeting ETCM, Guayaquil, Ecuador, 2016
- [21] Setz, C., Heinrich, A., Rostalski, P., et al.: 'Application of model predictive control to a cascade of river power plants', *Proceedings of the 17th World Congress of the Int Feder. Autom. Control*, 2008, **41**, (2), pp. 11978–11983
- [22] Maestre, J.M., et al.: 'A comparison of distributed MPC schemes on a hydro-power plant benchmark', *Opt. Control Appl. Methods*, 2014, **36**, pp. 306–332
- [23] Faille, D., Davelaar, F., Murgey, S., et al.: 'Hierarchical model predictive control applied to hydro power valley', *Proc. Int. Feder. Autom. Control*, 2012, **45**, (21), pp. 295–300
- [24] Hug-Glanzmann, G.: 'Predictive control for balancing wind generation variability using run-of-river power plants'. IEEE Power and Energy Society General Meeting, Detroit, USA, 2011, pp. 1–8
- [25] Dragicevic, T.: 'Model predictive control of power converters for robust and fast operation of AC microgrids', *IEEE Trans. Power Electron.*, 2018, **33**, (7), pp. 6304–6317
- [26] Zhang, Y., Liu, J., Yang, H.: 'New insights into model predictive control for three-phase power converters', *IEEE Trans. Ind. Appl.*, 2019, **55**, (2), pp. 1973–1982
- [27] Tomlinson, M., Mouton, H.T., Kennel, R., et al.: 'A fixed switching frequency scheme for finite-control-Set model predictive control - concept and algorithm', *IEEE Trans. Ind. Electron.*, 2016, **63**, (12), pp. 7662–7670
- [28] Hu, J., Zhu, J., Dorrel, D.G.: 'Model predictive control of inverters for both islanded and grid-connected operations in renewable power generations', *IET Renew. Power Gener.*, 2014, **8**, (3), pp. 240–248
- [29] Meral, M.E., Celik, D.: 'A comprehensive survey on control strategies of distributed generation power systems under normal and abnormal conditions', *Annu. Rev. Control*, 2019, **47**, pp. 112–132
- [30] Sguarezzi Filho, A.J., Oliveira Filho, M.E., Ruppert Filho, E.: 'A predictive power control for wind energy', *IEEE Trans. Sustain. Energy*, 2011, **2**, (1), pp. 1–8
- [31] Henriksen, L.C., Hansen, M.H., Poulsen, N.K.: 'Wind turbine control with constraint handling: a model predictive control approach', *IET Control Theory and Applications*, 2012, **6**, (11), pp. 1722–1734
- [32] Qi, W., Liu, J., Chen, X., et al.: 'Supervisory predictive control of standalone wind/Solar energy generation systems', *IEEE Trans. Control Syst. Technol.*, 2011, **19**, (1), pp. 199–207
- [33] Morsi, A., Abbas, S.H., Mohamed, A.M.: 'Wind turbine control based on a modified model predictive control scheme for linear parameter-varying systems', *IET Control Theory Appl.*, 2017, **11**, (17), pp. 3056–3068
- [34] Kassem, A.M., Abdelaziz, A.Y.: 'Reactive power control for voltage stability of standalone hybrid wind-diesel power system based on functional model predictive control', *IET Renew. Power Gener.*, 2014, **8**, (8), pp. 887–899
- [35] Aurora, C., Magni, L., Scattolini, R., et al.: 'Predictive control of thermal power plants', *Int. J. Robust Nonlinear Control*, 2004, **14**, (4), pp. 415–433
- [36] Rossiter, J.A., Neal, P.W., Yao, L.: 'Applying predictive control to a fossil-fired power station', *Trans. Inst. Meas. Control*, 2002, **24**, (3), pp. 177–194
- [37] Franzosi, R., Miotti, A., Pretolani, F., et al.: 'Traditional and advanced control of coal power plants: a comparative study'. Proc. of the 2006 American Control Conf. (ACC), Minneapolis, USA, 2006
- [38] Draganescu, M., Guo, S., Wojcik, J., et al.: 'Generalized predictive control for superheated steam temperature regulation in a supercritical coal-fired power plant', *CSEE J. Power Energy Syst.*, 2015, **1**, (1), pp. 69–77
- [39] Wang, L.: 'Model predictive control system design and implementation using MATLAB' (Springer, London, UK, 2009)
- [40] Hilderth, C.: 'A quadratic programming procedure', *Nav. Res. Logist. Q.*, 1957, **4**, pp. 79–85
- [41] Smart Grid Laboratory, Available at [www.fer.unizg.hr/zvne/research/research\\_labs/sglab/laboratory](http://www.fer.unizg.hr/zvne/research/research_labs/sglab/laboratory), accessed 12 August 2019



- [42] Kaunda, C.S., Kimambo, C.Z., Nielsen, T.K.: 'A technical discussion on microhydropower technology and its turbines', *Renew. Sustain. Energy Rev.*, 2014, **35**, pp. 445–459
- [43] Kuzle, I., Havelka, J., Pandzic, H., *et al.*: 'Hands-on laboratory course for future power system experts', *IEEE Trans. Power Syst.*, 2014, **29**, (4), pp. 1963–1971
- [44] Ljung, L.: 'MATLAB & SIMULINK: System Identification Toolbox - User's Guide'. MathWorks, 2018
- [45] Astrom, K.J., Hagglund, T.: '*PID controllers: theory, design and tuning*' (Instrument Society of America, Research Triangle Park, NC, 1995)
- [46] Jones, D.I., Mansoor, S.P., Aris, F.C., *et al.*: 'A standard method for specifying the response of hydroelectric plant in frequency-control mode', *Electr. Power Syst. Res.*, 2004, **68**, (1), pp. 19–32

## Publication 2

M. Beus and H. Pandžić, “Practical Implementation of a Hydro Power Unit Active Power Regulation Based on an MPC Algorithm,” *IEEE Transactions on Energy Conversion*, pp. 1–1, Jul. 2021, ISSN: 1558-0059. DOI: 10.1109/TEC.2021.3094059

# Practical Implementation of a Hydro Power Unit Active Power Regulation Based on an MPC Algorithm

Mateo Beus, *Student Member, IEEE* and Hrvoje Pandžić, *Senior Member, IEEE*

**Abstract**—Traditionally,proportional–integral–derivative (PID) based hydro turbine governors are mainly used due to their robustness and simple implementation. However, the weakness of these controllers is their design based on linear models and fixed parameters structure. This implies that the controller’s parameters are usually calculated for the critical operating point leading to the controller’s underperformance when operating away from the critical operating point. This paper introduces a Model Predictive Control (MPC) based hydro turbine’s governor load/frequency controller whose linear prediction model parameters are updated depending on the operating point. The main intention of the paper is to reduce the gap between theoretical contributions and industrial practice. The experimental validation is achieved by implementing the introduced MPC algorithm to a laboratory hydro power plant’s governor Programmable Logic Controller (PLC) and comparing its response with the responses of the gain-scheduled PI (GS-PI) controller, PI controller based on Particle Swarm Optimization (PSO-PI) and the controller based on exponential control law (EXP). Experimental results indicate the improvement in the response of a hydro power plant in the terms of primary response and settling time by using a load controller based on the MPC algorithm. The MPC controller reached 90% of the demanded step power change within 5.8 s, while the response in that case settles within 6.6 s. When using GS-PI and PSO-PI the hydro power plant reached 90% of demanded step power change within 7.9 s and 6.2 s, respectively. The response in case of GS-PI settles after 8.85 s, while in case of PSO-PI the response settles after 6.85 s. Additionally, it should be emphasized that in case of EXP controller the primary response reached desired level after 10.8 s which indicates that EXP controller violates the required response specifications in term of primary response criterion. However, in all cases the overshoot criterion was satisfied.

**Index Terms**—load frequency control, Pelton turbine, programmable logic controller, model predictive control, turbine governor.

## I. INTRODUCTION

In many power systems the hydro power plants are primarily used for frequency regulation due to their fast response capabilities. Namely, hydro power plants are capable of varying their power output over an entire operating envelope within 10 to 15 seconds, making them ideal candidates for the primary frequency regulation. Hydro turbine governor is a crucial component of any hydro power unit. In that regard, a great attention is devoted to the design and analysis of hydro turbine governors in the research community. Classical Proportional-Integral-Derivative (PID) controllers, due their simplicity and reliability, are the most commonly used controllers in the power sector. References [1], [2] provide comprehensive studies on hydraulic turbine models and hydro turbine governor PID design procedures.

Generally, the structure of each hydro turbine governor consists of two main controllers. The first controller, which is

known as the speed controller, is only active during the start up sequence while the hydro power unit is being synchronized to the grid. After synchronization the second controller, which is known as the load/frequency controller, takes over.

Although, PID-based hydro turbine governors have been proven efficient in practical applications, their main disadvantages are the controller’s fixed parameters selected upon the results of the linear models. However, hydro power plants are nonlinear systems and, therefore, the PID-based hydro turbine governors with fixed parameters can perform optimally only in the vicinity of the operating point considered during the governor design. Therefore, in the last few decades researchers have proposed many advanced control techniques for the design of the hydro turbine governors aimed to improve the hydro power plants control characteristics over the entire operating region. Many of the applied advanced control techniques rely on updating the controller parameters based on the current operating point.

In this paper, an MPC-based control algorithm for the design of hydro power plant’s load/frequency controller is introduced. A novelty of this algorithm lies in the fact that the controller’s internal linear prediction model parameters are being continuously updated depending on the current operating point. Furthermore, the algorithm has been implemented in a Programmable Logic Controller (PLC) and validated on a laboratory hydro power plant by comparing the response to the one of the GI-PI, PSO-PI and EXP load/frequency controllers.

The rest of the paper is organised as follows. Review of publications focused on hydro turbine governor design with an emphasis on hydro turbine governors based on predictive control algorithms is given in Section II. The proposed model of a laboratory hydro power unit is introduced in Section III. The MPC controller formulation, as well as the design of a benchmark GS-PI, PSO-PI and EXP controllers, is presented in Section IV. The experimental results are provided in Section V. The paper is concluded in Section VI.

## II. LITERATURE REVIEW

Traditionally, hydro turbine governors are based on classical PID controllers due to their reliability and simplicity. Thus, a large body of the literature is available in the context of the PID controller design for hydraulic turbines. For instance, in [3]– [4], the authors provide a review on hydro power plant model development and control, while in [5], the author propose a PID controller design for the control of hydraulic turbines over the entire operating envelope based on sensitivity margin specifications. The main conclusion of the paper is that due to the non-minimum phase behavior of hydraulic power unit the sensitivity margin represents a more adequate

metric to be used as a performance indicator compared to the commonly used phase and gain margin. Furthermore, the authors in [6] introduced a design procedure for a gain-scheduled PID based speed and load/frequency controllers for hydro turbine governors. The paper introduced a methodology for designing the gain-scheduled hydro turbine governor using a pole placement method. On the other hand, in [7], the authors presented a gain-scheduled controller for hydraulic turbine in which the PID controller parameters are calculated as a function of the guide vane angle. In addition, [8] developed a detailed mathematical and simulation model of a hydro power plant unit with double-regulated hydraulic turbine. In this case, a PID controller was applied as a hydro turbine governor for simulation purposes. Furthermore, the authors in [9] developed hydro power unit active power controller based on optimal exponential control law. The main objective of the introduced control law was to minimize the initial active power negative excursions due to the water hammer phenomenon.

Increased computation capabilities of microprocessors and PLCs used in the governor hardware have enabled the application of many advanced control techniques in hydro turbine governors, e.g. fuzzy-neural control, robust control, adaptive control, sliding mode control and predictive control.

In [10]– [11], the authors introduced hydro turbine governor based on fuzzy logic. In [10], a hydro turbine governor based on fuzzy logic was developed to control a hydro power plant with several hydraulically coupled turbines. The presented simulation with three turbines showed that the fuzzy-based controller may replace the commonly used control arrangement in which each turbine has an independent PID based hydro turbine governor. In [11], the authors proposed the fuzzy PID control strategy for controlling the governor of a hydro power plant during different fault conditions. In addition, the authors in [12]– [13] showed the application potential of a fuzzy-neural logic for the development of power system stabilizers, while in [14]– [15] the artificial neural networks were used to develop a control system that automatically adjusts the turbine speed based on the current operating conditions.

Power system stability is closely related to the stable operation of hydro power plants due to their role in primary frequency regulation. Thus, a great attention was given to the development of hydro turbine governors based on robust control algorithm. In [16]– [21], the authors applied robust control algorithms for the development of PID-based hydro turbine governor. In [16], the authors introduced an algorithm for stability design of a pole-placement adaptive controller based on the parameter space method. The simulation results have shown that the controller is robust and can guarantee system stability over the entire plant's operating region. Furthermore, in [18], the authors proposed a method for a robust PID controller design. The results have shown a good performance of the controller, ensuring stability over many operating points with respect to the guaranteed gain and phase margins. On the other hand, in [17], the authors investigated the dynamic behavior of hydraulically coupled turbines with emphasis on oscillations that can occur at certain frequencies during a black start. In that regard, the authors applied a robust control techniques for the synthesis of the controller that

takes into account these oscillations. Furthermore, the author in [21] applied an control algorithm based on optimal pole shift theory to damp out load angle and speed oscillations through the excitation and governor subsystems in a hydro power plant connected as single machine infinite bus system. The proposed control algorithm has been validated on light, normal and heavy load operating conditions. It is shown that the proposed control design is robust over a wide range of operating conditions.

In the context of advanced control techniques, the sliding mode control was also proven as a promising technique that can be applied to the design of hydro turbine governors. In [22]– [25], the authors applied a sliding mode control for hydro turbine governors. In [22], a hydro turbine governor is designed using the control method of reduced-order sliding mode. In that regard, a genetic algorithm is used to search a group of parameters of the predefined sliding surface. Furthermore, a fuzzy inference system is utilized to decrease the chattering problem. A similar approach was used in [23], where the authors designed a hydro turbine governor combining the sliding mode control with fuzzy logic. The robustness of the designed controller is guaranteed by a predefined sliding surface, while the chattering phenomenon is mitigated by the fuzzy logic. The authors in [26] introduced a complimentary sliding mode controller for the control of variable speed hydro power plant. The simulation results have shown the efficiency of the proposed controller during the wide range of operating conditions.

In addition to robust and fuzzy control, hydro turbine governors can also be designed based on evolutionary algorithms. For instance, in [27]– [32], evolutionary algorithms were applied to design hydro turbine governors. In [27] the authors introduced an improved evolutionary programming algorithm with a deterministic mutation factor for online PID parameters optimization of a hydro turbine governor. In addition, in [28]– [29], improved particle swarm optimization (PSO) techniques were applied for tuning the hydro turbine governor PID parameters. It was shown that the PSO is an effective and easily implementable method for optimal tuning of PID parameters in a hydro turbine governor. In addition, authors in [30]– [31] showed the application potential of the PSO for the development of power system stabilizers. In [32] the authors applied ant colony optimization technique to obtain the parameters of the PID controller. Simulation results have shown the PID controller whose parameters are obtained in that way outperforms the PID controller with parameters obtained using the classical Ziegler-Nichols technique.

In the context of the already mentioned advanced control techniques applied for to the design of hydro governors, a special place is reserved for predictive control algorithms. For instance, in [33] the authors employed a predictive feedforward control to help a hydro power plant achieve its target delivered power in the frequency control mode. It is shown that the predictive feedforward control can significantly improve a plant's response in part-load operation mode. It is important to emphasize that the control structure with fixed-parameter PID controller remains the same, while the predictive feedforward part can be easily integrated in the governor's PLC. This

feature is very important for practical applications. In [34], the authors applied a generalized predictive control algorithm to a multivariable model of a pumped stored hydro power plant. In order to demonstrate the possibilities of a predictive control algorithm, the response of the linear plant model with constrained predictive control algorithm is compared to the PI controller. The results indicate that the predictive control algorithm can ensure better performance across the operating envelope of the plant. Similarly, in [35] the authors applied an MPC algorithm whose linear prediction model parameters have been updated depending on the current operating point. The controller developed based on this algorithm is validated on a nonlinear ARX model of the hydro power plant that is identified based on the plant measurements. Furthermore, in [36] the authors applied a predictive control algorithm for the design of a hydro turbine governor based on neural networks. Namely, the control algorithm consists of a one-step ahead neuropredictor and neurocontroller. The neuropredictor tracks the dynamic characteristics of the plant and predicts the plant output, while the neurocontroller produces the optimal control signal. The proposed algorithm is validated on a linear simulation model of the plant. Furthermore, in [37]– [39] the authors introduced the control strategy for variable speed hydro power plants based on an MPC algorithm. Namely, an MPC controller was introduced to orchestrate the turbine controller with the virtual synchronous generator control of the power electronics converter used to integrate the hydro power plant in the grid. The simulation studies have shown that the virtual synchronous generator control is capable of providing fast power responses by utilizing the rotational energy of the turbine and the generator, while at the same time the MPC algorithm controls the guide vane opening of the turbine to regain the nominal turbine rotational speed. The main conclusion is that the proposed control system allows the variable speed hydro power plants to provide fast frequency reserves.

The review of the relevant papers indicates that some preliminary work on MPC applications to hydro turbine governors already exists. However, the main drawback of the proposed predictive control algorithms is that they are based on fixed-parameter linear prediction models. Furthermore, predictive control algorithms are mainly validated on linear simulation models of hydro power plants. This is quite unrealistic since hydro power plants are highly nonlinear systems whose parameters vary with the flow and net head. In addition, the existing state-of-the-art has not considered practical implementation potential of the proposed algorithms on the PLC of the hydro turbine governor. In that regard, the main intention of the paper is to reduce the gap between theoretical contributions and industrial practice. The main contributions are listed as follows:

- 1) an MPC-based control algorithm for the hydro power plant's load/frequency controller whose linear prediction model parameters are being updated depending on the current operating point;
- 2) an experimental validation by implementing the MPC algorithm on the laboratory hydro power plant's governor

PLC and comparing the MPC controller response with the responses of the GS-PI, PSO-PI and EXP load/frequency controllers.

### III. HYDRO POWER PLANT MODEL

In order to develop and validate our MPC control algorithm as well as the GS-PI, PSO-PI and EXP controllers that serve as a benchmark, a linear model of a laboratory hydro power plant located in Smart Grid Lab (SGLab) at the University of Zagreb Faculty of Electrical Engineering and Computing is derived [40]. A layout of a laboratory hydro power plant is shown in Fig. 1. The plant consists of a penstock, a Pelton turbine with one nozzle, an electrohydraulic actuator and a synchronous generator. The laboratory plant parameters are given in Table III in the Appendix.

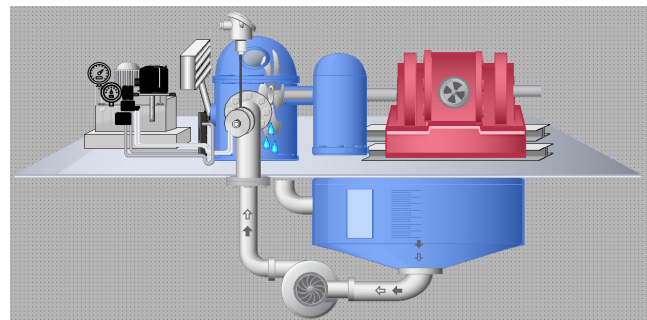

Fig. 1: A layout of the laboratory hydro power plant in the SGLab [35].

#### A. Penstock

The penstock dynamics is usually represented with a set of partial differential equations described in detail in [1]– [3]. These equations consider a one-dimensional water flow through a chosen plane of a penstock. In terms of the control system analysis, it is sufficient to consider only the dynamics on the penstock outlet [1].

Further simplification of the penstock model is approved in case of a very short penstock. This simplified model is usually referred to as a penstock model with non-elastic water column effect [3]. Equation (1) describes this simplified penstock model [3]:

$$h_{TC} = -T_w \frac{dq_T}{dt} \quad (1)$$

where  $T_w$  is the water inertia time constant expressed in s, while  $h_{TC}$  is the dynamic pressure at the penstock outlet.

In case of a laboratory hydro power plant, the penstock is very short and the linear penstock model is obtained by linearizing equation (1). The penstock transfer function has the following form:

$$F_p = \frac{\Delta h_{TC}(s)}{\Delta q_T(s)} = -T_w s \quad (2)$$

#### B. Pelton turbine

The laboratory hydro power plant at the SGLab contains a Pelton type of turbine. The turbine model is expressed using the following characteristic equations that relate the flow of water through the turbine and the mechanical power output as a function of the dynamic pressure, runner speed and needle opening [1]:

$$q_T = f_Q(h_{TC}, w_N, y) = y\sqrt{h_{TC}} \quad (\text{p.u.}) \quad (3)$$

$$P = f_P(h_{TC}, w_N, y) = A_t(q_T - q_{NL})h_{TC} - D_a y \Delta w \quad (\text{p.u.}) \quad (4)$$

where  $q_{NL}$  represents the water flow at no load expressed in p.u., i.e. at zero power output.  $D_a$  is a water turbine damping coefficient, while  $A_t$  is a transformation coefficient that relates the turbine and the generator base power. The expression used to calculate this coefficient is given in the Appendix. Furthermore,  $y$  represents the needle position at the end of the nozzle. By changing the needle position it is possible to control the water flow through the turbine and, consequently, the active power production of the hydro power unit.

Equations (3)–(4) render the turbine model nonlinear. To obtain a linear model of the turbine it is necessary to linearize eqs. (3)–(4) as follows:

$$\Delta q_T = k_{11}\Delta h_{TC} + k_{12}\Delta w_N + k_{13}\Delta y \quad (5)$$

$$\Delta P = k_{21}\Delta h_{TC} + k_{22}\Delta w_N + k_{23}\Delta y \quad (6)$$

where coefficients  $k_{1i}$  and  $k_{2i}$  ( $i = 1, 2, 3$ ) are defined as partial derivatives of the water flow  $f_Q$  and power function  $f_P$  in the following way:

$$k_{11} = \frac{\partial q_T}{\partial h_{TC}}, \quad k_{12} = \frac{\partial q_T}{\partial w_N}, \quad k_{13} = \frac{\partial q_T}{\partial y} \quad (7)$$

$$k_{21} = \frac{\partial P}{\partial h_{TC}}, \quad k_{22} = \frac{\partial P}{\partial w_N}, \quad k_{23} = \frac{\partial P}{\partial y} \quad (8)$$

By deriving partial derivatives expressions it is possible to calculate the linear turbine model parameters for different operating points. Each operating point is defined by the dynamic pressure, runner speed, and needle position  $(h_{TC0}, w_{N0}, y_0)$ .

### C. Electrohydraulic actuator

In the laboratory plant, the hydraulic piston is used as an actuator for needle positioning. By and large, the hydraulic unit turbine control system has slow dynamic behavior as compared to the dynamics of the hydraulic piston positioning control system. In that regard, the hydraulic piston positioning control system is expressed as a first-order element:

$$F_a = \frac{y}{u} = \frac{1}{T_a s + 1} \quad (9)$$

where  $T_a$  is the time constant of the hydraulic piston positioning system and  $u$  is a control signal (needle position set point) produced by the controller. In order to determine  $T_a$ , which is a time constant of the closed-loop hydraulic piston positioning control system, a step response of the hydraulic piston control system was measured on the laboratory hydro power plant. Fig. 2 shows a step response of 6% in the hydraulic piston position.  $T_a$  is defined as the time necessary for the piston to achieve 63% of the required final position. In this case,  $T_a$  is 0.12 s.

### D. Hydro power unit model

By combining the partial models of the hydro power plant's penstock, turbine, and electrohydraulic actuator, one can derive a linear model of the laboratory hydro power unit. The linear model of the plant that relates the turbine's mechanical power output with the needle position can be expressed by combining (2) and (5)–(6). In this paper we consider the hydro power plant load/frequency control (unit synchronized with the utility

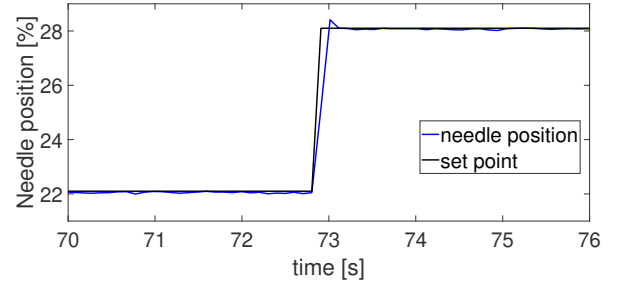

Fig. 2: Needle positioning.

grid), i.e.  $\Delta w_N = 0$ . Finally, the transfer function for the hydro power unit can be expressed as:

$$G(s) = \frac{\Delta P}{\Delta y} = \frac{k_{23} - (k_{13}k_{21} - k_{11}k_{23})T_w s}{(T_a s + 1)(1 + k_{11}T_w s)} \quad (10)$$

## IV. FORMULATION OF THE CONTROL ALGORITHM

### A. MPC Formulation

MPC, as an advanced control technique, is widespread in the scientific community and in the industrial process control. Although MPC is widespread in the industrial process control (see an overview in [41]), to the best of the authors' knowledge an MPC algorithm has not yet been implemented on the PLC of a hydro turbine governor. In that regard, the main goal of this paper is to demonstrate a practical implementation potential of an MPC algorithm in the hydro turbine governor by implementing an MPC-based load/frequency controller on the governor's PLC of a laboratory hydro power plant. Generally speaking, an MPC algorithm's calculates the optimal control sequence based on predictions of the plant's response by solving an optimization problem that includes different types of constraints, i.e. control signal amplitude and rate limit constraints. The fact that the MPC control algorithm deals naturally with the plant's constraints is the main advantage of this control algorithm as compared to the classical linear control methods. Since hydro power plants are nonlinear systems, in order to improve the plant's response characteristics over the entire operating envelope, we design an MPC algorithm whose linear prediction model parameters are updated depending on the current operating point. The following subsections introduce the formulation of an MPC algorithm for the load/frequency controller.

#### 1) Objective Function

The quadratic objective function to be minimized at each sampling instant  $k$  is given by:

$$J = \sum_{j=1}^N [P_*(k+j)k - R_s(k+j)]^2 \mathbf{Q} + \sum_{j=1}^{N_c} [\Delta u(t+j-1)]^2 \mathbf{R}, \quad (11)$$

where  $P_*$  and  $R_s$  are predicted plant's output and reference trajectories, respectively.  $N$  represents the prediction horizon, while  $N_c$  is the control horizon. In (11), the first term represents the error between the predicted plant's output and the reference trajectory, while the second term represents the control effort.  $\mathbf{Q}$  and  $\mathbf{R}$  are positive weighting matrices.  $\mathbf{Q}$  penalizes the predicted plant's output deviation from the reference trajectory, while  $\mathbf{R}$  penalizes the change of the

control signal value.

### 2) Predictive Model of the Plant

Structure of the linear discrete-time model for different operating points is obtained by discretizing (10) with sampling period  $T_s$  set to 50 ms:

$$G_*(z) = \frac{P_*(z)}{u(z)} = \frac{c_3 z + c_4}{z^2 + c_1 z + c_2}, \quad (12)$$

where coefficients  $c_1$ ,  $c_2$ ,  $c_3$  and  $c_4$  are calculated offline for different operating points and noted in a look up table. Each operating point is defined by the specific dynamic pressure, runner speed and needle position. The discrete-time predictive model used in this paper is derived based on a generalized formulation of the Controlled Auto Regressive Moving Average (CARIMA) expressed as:

$$a(z)\Delta P_*(k) = b(z)\Delta u(k) + T(z)\epsilon(z). \quad (13)$$

Since in our laboratory hydro power plant the active power production measurements are directly available, the prediction model uses variables of the output and input increments and assumes the best estimate of the future random term  $T(z)\epsilon(z) = 0$ .

In (13),  $a(z)$  is a polynomial that represents the denominator of the transfer function, while  $b(z)$  is a polynomial that represents the numerator of the transfer function. These polynomials are expressed as:

$$a(z) = 1 + a_1 z^{-1} + \dots + a_n z^{-n}, \quad a(z)\Delta = A(z), \quad (14)$$

$$b(z) = b_1 z^{-1} + \dots + b_m z^{-m}. \quad (15)$$

where  $\Delta$  is the  $(1 - z^{-1})$  operator. The prediction model expressed in this way does not require a disturbance estimate since it is implicit within the increments. A compact matrix/vector form used to express the laboratory hydro power plant active power production predictions is given by:

$$P_{*k+1} = \mathbf{K}_0 \Delta U_{\underline{k}} + \mathbf{K}_1 \Delta U_{\underline{k-1}} + \mathbf{K}_2 P_{*k}, \quad (16)$$

where  $\mathbf{K}_0$ ,  $\mathbf{K}_1$  and  $\mathbf{K}_2$  matrices are expressed as:

$$\mathbf{K}_0 = C_A^{-1} C_b, \mathbf{K}_1 = C_A^{-1} H_b, \mathbf{K}_2 = C_A^{-1}. \quad (17)$$

Matrices  $C_A$ ,  $C_b$ ,  $H_A$  and  $H_b$  are given in the Appendix.

In (16), the vector  $P_{*k+1}$  represents the predicted active power production, while vector  $\Delta U_{\underline{k}}$  represents the control sequence in a form of the needle position increments. These vectors are expressed as follows:

$$P_{*k+1} = [P_*(k+1) \ P_*(k+2) \ \dots \ P_*(k+N)]^T \quad (18)$$

$$\Delta U_{\underline{k}} = [\Delta U(k) \ \Delta U(k+1) \ \dots \ \Delta U(k+N_c-1)]^T \quad (19)$$

Since the MPC algorithm formulated in this paper is set up in a way that the control signal increment, i.e. the needle position, is calculated at each time instant  $k$ , the control signal produced by the controller at time instant  $k$  is expressed as:

$$U(k) = U(k-1) + \Delta U(k). \quad (20)$$

### 3) Constraints

MPC as a control technique is widespread due to its ability to incorporate different types of constraints on control and output signals into the control design. In this paper, the MPC formulation includes constraints on the control signal, i.e. needle position rate and amplitude constraints. These constraints are expressed as:

$$\Delta U^{\min} \leq \Delta U \leq \Delta U^{\max} \quad (21)$$

$$U^{\min} \leq U \leq U^{\max} \quad (22)$$

where  $\Delta U^{\min}$ ,  $\Delta U^{\max}$ ,  $U^{\min}$  and  $U^{\max}$  are column vectors with  $N_c$  elements of  $\Delta u^{\min}$ ,  $\Delta u^{\max}$ ,  $u^{\min}$ ,  $u^{\max}$ . A compact matrix formulation of these constraints over the entire control horizon is:

$$\mathbf{M} \Delta U \leq m, \quad (23)$$

where  $\mathbf{M}^{[4N_c \times N_c]}$  and  $m^{[4N_c \times 1]}$  are formulated as:

$$\mathbf{M} = \begin{bmatrix} I \\ -I \\ L \\ -L \end{bmatrix}, m = \begin{bmatrix} l(\Delta u^{\max}) \\ l(\Delta u^{\min}) \\ l(u^{\max} - u(k-1)) \\ l(u^{\min} + u(k-1)) \end{bmatrix}, l = \begin{bmatrix} 1 \\ 1 \\ \vdots \\ 1 \end{bmatrix}.$$

The dimension of vector  $l$  is  $[N_c \times 1]$ .

Objective function (11) and constraints (16) and (23) form a quadratic programming (QP) optimization problem. This QP problem is solved at each sampling instant  $k$  using the Hildreth algorithm. This solver is chosen due to its two important features essential for real-time applications: solver robustness and simplicity of implementation on the governor PLC. Details on the formulation of Hildreth algorithm are given in [42]–[43].

The execution steps of the MPC algorithm on the PLC are given in **Algorithm 1**. The distinction is made between the steps that are conducted offline and online. In the offline part of the algorithm, for known values of  $N$  and  $N_c$  matrices  $\mathbf{K}_0$ ,  $\mathbf{K}_1$ ,  $\mathbf{K}_2$  and  $\mathbf{M}$  are precomputed. As a part of the online calculations routine, the linear prediction model parameters are found in the look-up table (step 4) based on the current measurements that are closest to the available operating point (OP) defined in the look-up table. Furthermore, in step 5 the Hildreth algorithm is called to solve the QP problem. Online execution steps are explained in detail in **Algorithm 1**.

### B. Gain Scheduled PI Governor

To make a fair comparison, the fixed parameter PI controller currently implemented in the laboratory hydro power plant was modified. In that regard, a gain-scheduled PI controller using a pole placement method was designed and the proportional feedforward term was included in the controller design. The linear plant model in (10) is used to calculate the PI controller settings for different operating points. For consistency, the PI controller settings are calculated for the same operating points as the linear prediction model parameters included in the MPC algorithm. The settings of the PI controller for each operating point are calculated choosing the positions of the poles in a way that the system has reasonable values of the phase margin ( $30^\circ \leq P_m \leq 60^\circ$ ) and the gain margin ( $2 \leq G_m \leq 5$ ) [44]. Equation (24) is used to express how the modified PI controller calculates the control signal.

$$u = P_{SP} K_{ff} + (P_{SP} - P) \left( K_p + \frac{K_i}{s} \right) \quad (24)$$

In eq. (24),  $K_{ff}$  is a feedforward term, while  $K_p$  and  $K_i$  represent proportional and integral terms.  $P_{SP}$  represents the active power set point.

---

**Algorithm 1: MPC algorithm**

---

**OFFLINE:**

1.  $N_c, N, M$
2. Calculate matrices  $\mathbf{K}_0, \mathbf{K}_1, \mathbf{K}_2$ .
- for different operating points (OP)  $(h_{TC}, w_N, y)$
3. Create the look-up table
- for all precomputed linear prediction model parameters

**ONLINE:**

```

while CPU is in run mode do
  if 50 ms passed since the last call then
    1. CALL MPC controller function
    2. Read input/output values from the last sampling
       instants to form vectors  $\Delta U_{k-1}, P_{*k}$ 
    3. Read pressure (h), needle opening (y) and power
       (P) measurements
    4. while OP closest to the measurements not found
       do
         | 4.1 Search in the look-up table
       end
    5. CALL Hildreth algorithm
    6. Calculate the unconstrained solution
    7. if unconstrained solution violates constraints then
       | 7.1. while maximum number of iterations is not
       |   reached and solution not found do
       |   | 7.1.1 Solve one iteration of the QP
       |   | 7.1.2. if maximum number of iterations is
       |   |   reached then
       |   |   | 7.1.2.1 Use the unconstrained solution
       |   |   |   limited to the constraints
       |   end
       | end
    else
       | 7.2 Use unconstrained solution
    end
    8. Apply the first control sequence
       value for needle positioning
    9. Save the input/output values
       from the current sampling instant
    end
  end
end

```

---

### C. PSO based PI Governor

The conducted literature review revealed that different control techniques have been considered for the development of hydro turbine governors. PSO, as a representative of a meta heuristic algorithms, has shown a good potential for tuning of PID-based hydro turbine governors. The authors in [28]– [29] elaborated in detail how a PSO algorithm can be applied for tuning of PID gains in the hydro turbine governor. To demonstrate the practical application potential of a hydro turbine governor based on a predictive control algorithm, a standard PSO algorithm extended with the constriction coefficients defined in (25)–(29) was applied to determine the PI parameters for the PI controller currently implemented in the laboratory hydro power plant. Furthermore, the PSO algorithm conducted a search for PI parameters by minimizing integral square of error, i.e. ISE, as a objective function (30) of the algorithm. The response of the PSO-based PI controller was compared to the response of the MPC-based controller.

Constriction coefficients:

$$\phi = \phi_1 + \phi_2 \quad (25)$$

$$\chi = \frac{2}{\left|2 - \phi - \sqrt{\phi^2 - 4\phi}\right|} \quad (26)$$

$$w = \chi \quad (27)$$

$$c_1 = \chi\phi_1 \quad (28)$$

$$c_2 = \chi\phi_2 \quad (29)$$

where  $w$  is inertia weight, while  $c_1$  and  $c_2$  are acceleration factors in the PSO algorithm.

Objective function:

$$J_{PSO} = \int e^2 dt \quad (30)$$

where  $e$  represents error, i.e. the difference between set point value and active power measurement as defined in (24). PSO controller settings are available in Table II.

### D. Exponential Control Law

Another promising control technique for the practical application in the hydro turbine governors is the exponential control law. The main goal of the controller with optimal exponential control law is to minimize the effect of non-minimum phase behavior of the hydro power plant. To demonstrate the practical application potential of the predictive control algorithm introduced in this paper, the hydro turbine governor based on the exponential control law was implemented to the laboratory hydro power plant. The response of the MPC controller was compared to the response of the controller with the exponential control law.

Fig. 3 shows the main steps in the execution of the exponential control law implemented in the laboratory hydro power plant. In this case exponential control law formulation was used from [9].

In Fig. 3 steps 1 and 2 are used to agree sign of error  $e$  and initial control signal rate of change. On the other hand, steps 10 and 11 are responsible for the inverse conversion. Step 3 checks the sign of control action from the previous control cycle. If the control signal changed sign, the control signal rate of change in this cycle shall be defined as in step 4. However, if the control signal has the same sign as in previous cycle, then the control signal rate of change in this cycle increases with the exponential law as defined in step 5. Steps 6 and 7 limit the control signal rate of change to the maximum allowed value. Finally, Steps 7 and 8 reduce the speed at the final phase of control transient when the turbine power approaches the set point.

## V. EXPERIMENTAL RESULTS

Practical validation of the introduced MPC control strategy for active power regulation in the hydro power plant is performed using PLC Siemens ET200 SP with CPU 1512SP-1 PN. The CPU has a 16-bit resolution, which means that an analog input of 10 VDC or 24 mA will be represented by an integer value of 27648. 5 MB of the CPU's work memory is reserved for data, while 1 MB is reserved for the program. Memory card of 24 MB is used for load memory. The CPU processing time is between 10 ns (bit operations) and 64 ns (floating-point arithmetic) [45]. Process image input/output minimum update time is 39  $\mu$ s/word, while the basic time expenditure



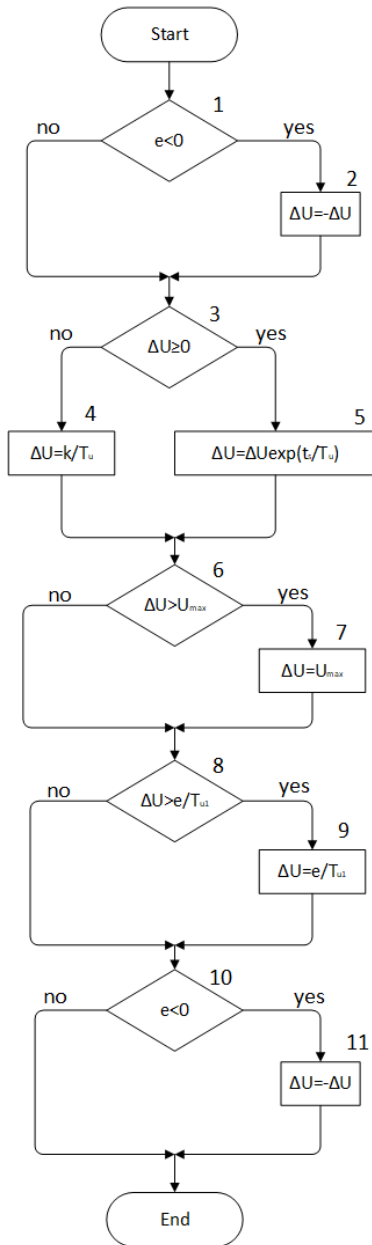

Fig. 3: Exponential rate of change calculation algorithm [9].

for an interrupt is 80  $\mu$ s. The laboratory hydro power plant experimental setup is shown in Fig. 4.

Practical validation of the proposed MPC algorithm was performed by comparing the response of the MPC controller with the responses of the GS-PI controller, PSO-PI controller and the controller based on the exponential control law. In [46], the criteria for validation of the hydro power plant step response is introduced. In this analysis only three criteria (primary response ( $C_1$ ), overshoot ( $C_2$ ) and settling time ( $C_3$ )) will be considered, while the non-minimum phase (NMP) behavior as the last criterion is neglected. Namely, the NMP behavior of a hydro power plant is caused by the water inertia effect. We neglect this effect due to a very short penstock of the laboratory hydro power plant and the fact that the water pressure at the end of penstock is regulated by a water pump.

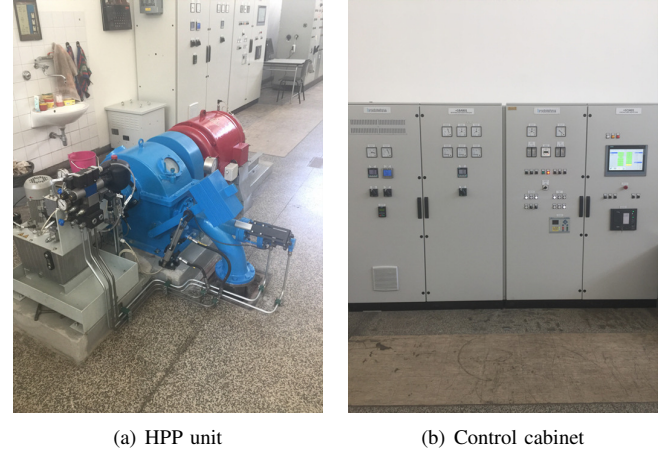

Fig. 4: HPP experimental setup in the SGLab.

This implies that the pressure variations are very low during the change of the operating point. One can see this effect in Fig. 7. It is visible that for a power increase of 4 kW (0.34 p.u.) the pressure is decreased for only 0.05 bar. Therefore, the NMP effect is barely visible in the power responses shown in Fig. 5.

Table I shows the criteria used to validate the quality of the responses. Criterion  $C_1$  defines that at least 90% of the demanded step power change should be realized within the specified time  $t_{C_1}$ , while  $C_2$  represents the overshoot reached within the specified time  $t_{C_2}$ . The last criterion  $C_3$  defines the settling time of the response. Furthermore, this criterion also defines that the steady-state error of the response should be less than 0.5%.

#### A. Controller settings

The controller settings used for experimental validation are given in Table II. The weighting factors for the MPC were chosen in a way that the reference tracking has a priority over the control effort, i.e. more aggressive control movements are allowed. The sampling time is  $T_s=50$  ms.

#### B. Experimental validation

To demonstrate the effectiveness of the proposed controller we conduct a demonstration in which an active power step change of 4 kW is applied. The recorded power responses are shown in Fig. 5.

The black dotted line presents the active power point set point. The blue line represents the response when the MPC controller is active, while the black line represents the response obtained with the PSO-PI controller. Furthermore, the green line represents the response obtained by the GS-PI controller, while the red line represents the response of the EXP controller. Initially, during the first 9.6 s the laboratory hydro power plant produces 1 kW at operating point ( $h_{TC} = 6.4$

TABLE I: Specifications for the control design [46].

Criterion	Specification for single unit step response
$C_1$ - rise time	$C_1 \geq 90\%$ at $t_{C_1} = 10$ s
$C_2$ - overshoot	$C_2 \leq 4\%$ and $t_{C_2} \leq 15$ s
$C_3$ - settling time	$t_{C_3} = 30$ s for $C_3 \leq 0.5\%$

TABLE II: Controller settings.

Controller	Settings	
	MPC	$N = 6$
$u^{\max} = 65\%$		$u^{\min} = 8\%$
$\Delta u^{\max} = 0.4\%$		$\Delta u^{\min} = -0.4\%$
$Q = 1000$		$R = 1$
PSO-PI	$\phi_1 = 2.05$	$\phi_2 = 2.05$
	$\chi = 0.73$	$w = 0.73$
	$c_1 = 1.49$	$c_2 = 1.49$
	$K_p = 0.32$	$K_i = 0.38$
GS-PI	$K_p = 0.2$	$K_i = 0.2$
EXP	$T_u = 2.5$	$T_{u1} = 2$
	$k = 0.12$	$\Delta u^{\max} = 0.2\%$

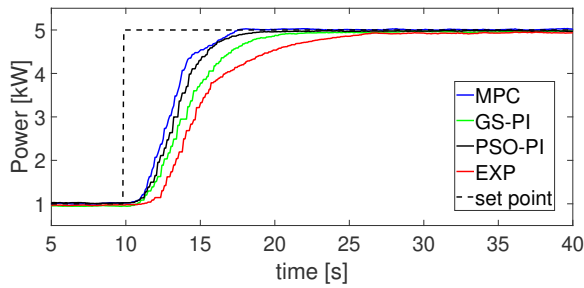

Fig. 5: Power tracking.

bar,  $w = 104.79$  rad/s,  $y = 10\%$ ). At  $t = 9.6$  s, a step demand of 4 kW (34.48% of the rated power) is applied to the plant causing the increase of power production to 5 kW (43.1% of the rated power). The quality of the response of each controller is quantified by calculating the criteria  $C_1$ - $C_3$  and comparing them to the specifications given in Table I. Criterion  $C_1$  is satisfied with MPC, PSO-PI and GS-PI controllers, while the EXP controller violates it. The primary response obtained with MPC is 4.2 s faster than the specified time  $t_{C_1}$ , while the PSO-PI primary response is 3.8 s faster than the  $t_{C_1}$ . Furthermore, the primary response obtained by the GS-PI controller is 2.1 s faster than the specified time  $t_{C_1}$ , while the EXP primary response does not satisfy criterion  $C_1$ . Namely, the EXP controller response violates the criterion  $C_1$  since 90% of demanded step power change (4.6 kW) has been reached at  $t = 20.4$  s, which is 0.8 s slower the specified time  $t_{C_1}$ . Related to criterion  $C_2$ , all controllers satisfy the specifications. Overshoot of the MPC controller response at specified time  $t_{C_2}$  is 3.8% lower as compared to the value defined by the criterion  $C_2$ . On the other hand, the PSO-PI, GS-PI and EXP controllers do not result in overshoot. In all cases the responses settle before time  $t_{C_3}$  specified by  $C_3$  criterion. In case of the MPC controller, the response settles after 6.6 s, while in the case of PSO-PI controller, the response settles after 6.85 s. Furthermore, in case of the GS-PI controller the response settles after 8.85 s, while the EXP controller response settles after 12.95 s. By comparing the criteria values for all controllers, one can conclude that MPC, PSO-PI and GS-PI controllers satisfy the imposed response specifications. However, the MPC controller shows superiority in terms of primary response and settling time, while PSO-PI and GS-PI controllers demonstrate superiority in terms of

overshoot. Furthermore, the control signal responses given in Fig. 6 indicate that the control signal satisfies the constraints defined in Table II. The blue line representing the control signal produced by the MPC controller has more aggressive control movements as compared to the the control signal produced by the PSO-PI (black line), GS-PI (green line) and EXP (red line) controllers. This can be explained by the fact that weighting factor  $R$  used to penalise the control effort is 1000 times lower than the weighting factor  $Q$  used to penalise the reference tracking allowing highly aggressive control movements.

Although each operating point is determined by the pressure, the rotational speed and the control signal value (needle position), in case of the load controller, i.e. when the unit operates in parallel with the grid, rotational speed can be considered constant. In that regard, Fig. 8 proves it is reasonable to make that assumption. Namely, the nominal rotational speed of the laboratory power plant is 104.74 rad/s. Therefore, all controllers considered only the changes in the pressure and needle position, while the rotational speed is considered to be constant for all operating points.

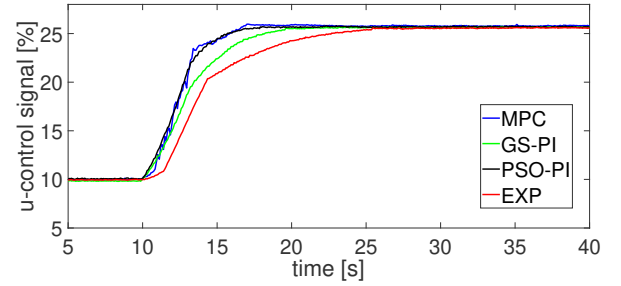

Fig. 6: Control signal.

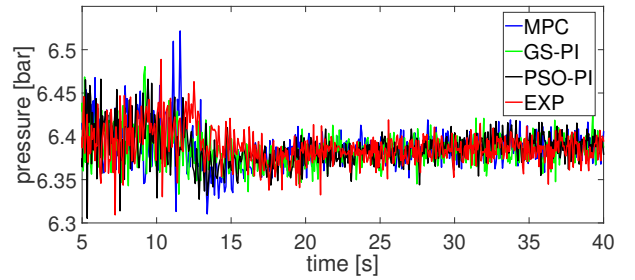

Fig. 7: Pressure variations.

Although all controllers, except EXP controller, satisfy the response specification, these are not optimal control parameters. In case of the PI-based controllers it is possible to increase/decrease the response by tuning the PI parameters, while in case of EXP controller the response can be increased/decreased by changing the parameters  $T_u$ ,  $T_{u1}$ ,  $U_{max}$  and  $k$ . Furthermore in case of the MPC controller a similar effect can be achieved by tuning the weighting factors  $Q$  and  $R$  or by changing the constraints on the control signal. This effect is visible in Fig. 9, where the responses for different values of the control signal rate limit are shown. Namely,

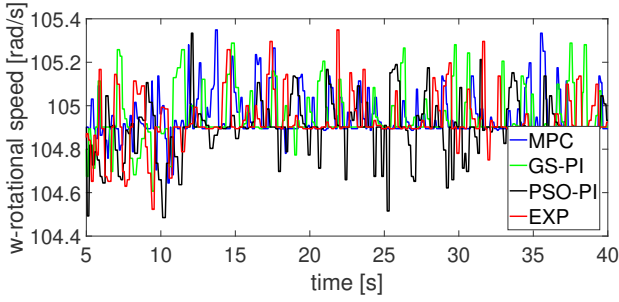

Fig. 8: Turbine runner rotational speed.

the control signal rate limit was varied from 0.4% to 1%. As expected, the lowest value of the control signal rate limit (0.4% - the magenta line) produced the slowest response, while the highest value of the control signal rate limit (1% - the blue line) produced the fastest response. In terms of criterion  $C_1$  the response when the signal rate limit is 0.4% has a primary response 4.2 s faster than the specified time  $t_{C_1}$ , while the primary response when the signal rate limit is 1% is 5.84 s faster than a time  $t_{C_1}$ . Related to criterion  $C_2$  the responses satisfied the specifications. All the responses have an overshoot less than 2.5%. In all cases the response settles within the specified time  $t_{C_3}$ . Namely, in case when control signal rate limit is 0.4% the response settles after 6.6 s, while in case when control signal rate limit is 1% the response settles after 4.15 s.

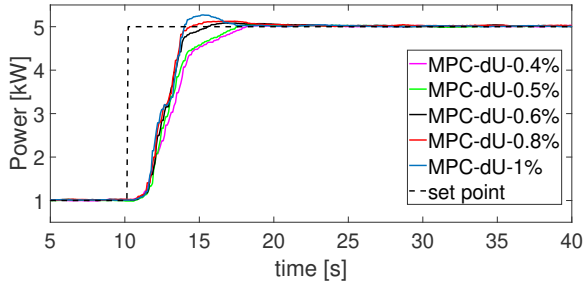

Fig. 9: MPC responses for different values of the control signal rate limit.

## VI. CONCLUSION

The main aim of this paper is to reduce the gap between the theoretical contributions and the industrial practice related to hydro turbine governors. The paper investigates practical implementation potential of an MPC-based load controller in the hydro turbine governor. In that regard, an MPC based load controller is developed and implemented on the governor's PLC. To validate its quality, the response of the predictive controller is compared to the response of the PSO-PI, GS-PI and EXP controllers, all of which were implemented on the governor's PLC. A comparison of the responses showed that with the MPC controller the hydro power plant reached 90% of the demanded step power change within 5.8 s, while the response in that case settled within 6.6 s. Furthermore, the responses of the GS-PI and PSO-PI controllers also satisfied the required response specifications. Namely, in case of GS-PI and PSO-PI controller, the hydro power plant reached 90% of the demanded step power change within 10 s and the responses

settled within 30 s. However, in case of the EXP controller the hydro power plant reached 90% of the demanded step power change after 10.8 s, which indicates that the EXP controller violates the required response specifications. In all cases the overshoot criterion was satisfied. Experimental validation demonstrates that it is possible to improve the response of a hydro power plant in terms of primary response and settling time by using a load controller based on the MPC algorithm. Thus, we conclude that predictive control algorithms have practical implementation potential in the hydro turbine governors and should be considered in industrial practice.

## APPENDIX

TABLE III: SGLab hydro power plant parameters [35].

Number of units	1
Type of turbine	Pelton
Rated power ( $P_n$ )	11.6 kW
Rated speed ( $n$ )	1000 rpm
Rated flow ( $Q_n$ )	$0.022 \text{ m}^3 \text{ s}^{-1}$
Net head ( $H_n$ )	64 m
Length of penstock ( $L_p$ )	2 m
Penstock diameter ( $D_p$ )	0.15 m

Water inertia time constant  $T_w$  [1]:

$$T_w = \frac{L_p Q_n}{\frac{D_p^2}{4} \pi g H_n}$$

$A_t$  coefficient [1]:

$$A_t = \frac{1}{y_{FL} - y_{NL}}$$

Matrices  $C_A$ ,  $C_b$ ,  $H_A$  and  $H_b$ :

$$C_A = \begin{bmatrix} 1 & \dots & 0 & 0 \\ A_1 & 1 & 0 & 0 \\ \vdots & \ddots & \vdots & 0 \\ A_{N-1} & A_{N-2} & \dots & 1 \end{bmatrix},$$

$$H_A = \begin{bmatrix} A_1 & A_2 & \dots & A_{n-4} & A_{n-3} & \dots & A_{n-1} & A_n \\ A_2 & A_3 & \dots & A_{n-3} & A_{n-2} & \dots & A_n & 0 \\ \vdots & \dots & \dots & A_{n-2} & A_{n-1} & \dots & 0 & 0 \\ A_N & A_{N+1} & \dots & A_{n-1} & A_n & \dots & 0 & 0 \end{bmatrix},$$

$$C_b = \begin{bmatrix} b_1 & 0 & 0 & 0 \\ b_2 & b_1 & 0 & 0 \\ \vdots & \ddots & \vdots & 0 \\ b_N & b_{N-1} & \dots & b_1 \end{bmatrix},$$

$$H_b = \begin{bmatrix} b_2 & b_3 & \dots & b_{m-4} & b_{m-3} & \dots & b_{m-1} & b_m \\ b_3 & b_4 & \dots & b_{m-3} & b_{m-2} & \dots & b_m & 0 \\ \vdots & \dots & \dots & b_{m-2} & b_{m-1} & \dots & 0 & 0 \\ b_{N+1} & b_{N+2} & \dots & b_{m-1} & b_m & \dots & 0 & 0 \end{bmatrix}.$$

## ACKNOWLEDGMENT

This work was funded by the European Union through the European Regional Development Fund Operational programme Competitiveness and Cohesion 2014–2020 of the Republic of Croatia under project No.KK.01.1.1.07. "Universal Communication and Control System for Industrial Facilities". The content of this work is the sole responsibility of the University of Zagreb Faculty of Electrical Engineering and Computing.

## REFERENCES

- [1] IEEE Working Group on Prime Mover and Energy Supply Models for System Dynamic Performance Studies, "Hydraulic turbine and turbine control models for system dynamic studies," *IEEE Trans. Power Syst.*, vol. 7, no. 1, pp. 167-179, 1992.
- [2] IEEE Power and Energy Society, "Dynamic Models for Turbine-Governors in Power System Studies," Technical Report PES-TR1, 2013. Accessed on: Nov., 2, 2020. [Online]. Available: [https://site.ieee.org/fw-pes/files/2013/01/PES\\_TR1.pdf](https://site.ieee.org/fw-pes/files/2013/01/PES_TR1.pdf).
- [3] N. Kishor, R. P. Saini, and S. P. Singh, "A review on hydropower plant models and control," *Renewable and Sustainable Energy Reviews*, vol. 11, pp. 776-796, 2007.
- [4] R. Kumari et al., "Development Trends and Future Prospects of Hydro-Turbine Control Systems," *2019 IEEE Industry Applications Society Annual Meeting*, pp. 1-10, 2019.
- [5] P. Husek, "PID controller design for hydraulic turbine based on sensitivity margin specifications," *Elect. Power and Energy Syst.*, vol.55, pp. 460-466, 2014.
- [6] B. Strah, O. Kuljaca, and Z. Vukic, "Speed and Active Power Control of Hydro Turbine Unit," *IEEE Trans. Energy Conv.*, vol.20, no.3, pp. 424-434, 2005.
- [7] G. Oreilind, L. Wozniak, J. Medanic, and T. Whitmore, "Optimal PID gain schedule for hydrogenerators - design and application," *IEEE Trans. Energy Conv.*, vol.4, no.2, pp. 300-307, 1989.
- [8] M. Brezovec, I. Kuzle, and T. Tomisa, "Nonlinear Digital Simulation Model of Hydroelectric Power Unit With Kaplan Turbine," *IEEE Trans. Energy Conv.*, vol.21, no.1, pp. 235-241, 2006.
- [9] Y. Kazantsev et al., "Hydro Unit Active Power Controller Minimizing Water Hammer Effect", *2020 Ural Smart Energy Conference (USEC)*, pp. 47-50, Ekaterinburg, Russia, 2020.
- [10] M. Mahmoud, K. Dutton, and M. Denman, "Design and simulation of a nonlinear fuzzy controller for a hydropower plant," *Electr. Power Syst. Res.*, vol. 73, issue 2, pp. 87-99, 2005.
- [11] A. Sami, M.B. Kadri, N. Aziz and Z. Pirwani, "Design and Simulation of Fuzzy PID for Hydro Power Plant," *2016 Sixth International Conference on Innovative Computing Technology (INTECH)*, pp. 683-687, 2016.
- [12] S.M. Radaideh, I.M. Nejdawi, and M.H. Mustaha, "Design of power system stabilizers using two level fuzzy and adaptive neuro-fuzzy inference systems," *Elect. Power and Energy Syst.*, vol. 35, issue 1, pp. 47-56, 2012.
- [13] H.E.A. Talaat, A. Abdennour, and A.A. Al-Sulaiman, "Design and experimental investigation of a decentralized GA-optimized neuro-fuzzy power system stabilizer," *Elect. Power and Energy Syst.*, vol. 32, issue 7, pp. 751-759, 2010.
- [14] J.F. Ardanuy, J.R. Wilhelmi, J.J.F. Mora and J.I. Perez, "Variable-Speed Hydro Generation: Operational Aspects and Control," *IEEE Trans. Energy Conv.*, vol. 21, no. 2, pp. 569-574, 2006.
- [15] D. Borkowski and T. Al-Wegiel, "Small Hydropower Plant With Integrated Turbine-Generators Working at Variable Speed," *IEEE Trans. Energy Conv.*, vol. 28, no. 2, pp. 452-459, 2013.
- [16] O.P. Malik, and Y. Zeng, "Design of a Robust Adaptive Controllers for a Water Turbine Governing System," *IEEE Trans. Energy Conv.*, vol.10, no.2, pp. 354-359, 1995.
- [17] H.N. Villegas Pico, et al., "Analysis of Hydro-Coupled Power Plants and Design of Robust Control to Damp Oscillatory Modes," *IEEE Trans. Power Syst.*, vol.30, no.2, pp. 632-643, 2015.
- [18] K. Natarajan, "Robust PID Controller Design for Hydroturbines," *IEEE Trans. Energy Conv.*, vol.20, no.3, pp. 661-667, 2005.
- [19] J. Jiang, "Design of an Optimal Robust Governor for Hydraulic Turbine Generating Units," *IEEE Trans. Energy Conv.*, vol.10, no.1, pp. 188-194, 1995.
- [20] J. Liang et al., "Nonlinear dynamic analysis and robust controller design for Francis hydraulic turbine regulating system with a straight-tube surge tank," *Mech. Syst. and Signal Proc.*, vol.85, pp. 927-946, 2017.
- [21] N. Kishor, "Oscillation Damping With Optimal Pole-Shift Approach in Application to a Hydro Plant Connected as SMIB System," *IEEE Systems Journal.*, vol.3, no. 3, pp. 317-330, 2009.
- [22] C. Xu, and D. Qian, "Governor Design for a Hydropower Plant with an Upstream Surge Tank by GA-Based Fuzzy Reduced-Order Sliding Mode," *Energies*, vol.8, pp. 13442-13457, 2015.
- [23] X. Yuan, Z. Chen, Y. Yuan and Y. Huang, "Design of fuzzy sliding mode controller for hydraulic turbine regulating system via input state feedback linearization method," *Energy*, vol.93, part 1., pp. 173-187, 2015.
- [24] D. Qian, J. Yi, and X. Liu, "Design of Reduced Order Sliding Mode Governor for Hydro-turbines," *2011 American Control Conference (ACC 2011)*, San Francisco, USA, 2015.
- [25] Z. Chen et al., "Parameter estimation of fuzzy sliding mode controller for hydraulic turbine regulating system based on HICA algorithm," *Renewable Energy*, vol. 133, pp. 551-565, 2019.
- [26] R. Kumari et al., "Improved Hydro-Turbine Control and Future Prospects of Variable Speed Hydropower Plant," *IEEE Trans. on Industry Applications*, vol.57, no. 1, pp. 941-952, 2020.
- [27] C. Jiang, Y. Ma, and Z. Wang "PID controller parameters optimization of hzdro-turbine governing system using deterministic-chaotic-mutation evolutionary programming (DCMEP)," *Energy Conv. and Manag.*, vol. 47, issues 9-10 pp. 1222-1230, 2005.
- [28] H. Fang, L. Chen, and Z. Shem, "Application of an improved PSO algorithm to optimal tuning of PID gains for water turbine governor," *Energy Conv. and Manag.*, vol. 52, issue 4, pp. 1763-1770, 2011.
- [29] C. Gonggui et al., "PID Parameters Optimization Research for Hydro Turbine Governor by an Improved Fuzzy Particle Swarm Optimization Algorithm," *The Open Electrical Electronic Engin. Jour.*, vol. 10, pp. 101-117, 2016.
- [30] H.E. Mostafa, M.A. El-Sharkawy, A.A. Emary and K. Yassin, "Design and allocation of power system stabilizers using the particle swarm optimization technique for an interconnected power system," *Electr. Power and Energy Syst.*, vol. 34, issue 1, pp. 57-65, 2012.
- [31] E.S. Ali and S.M. Abd-Elazim, "BFOA based design of PID controller for two area Load Frequency Control with nonlinearities," *Electr. Power and Energy Syst.*, vol. 51, pp. 224-231, 2013.
- [32] O. Singh and A. Verma, "Frequency Control for Stand-Alone Hydro Power plants using Ant Colony Optimization", *2020 IEEE International Conference on Advent Trends in Multidisciplinary Research and Innovation (ICATMRI)*, pp. 1-6, Buldhana, India, 2020.
- [33] D. Jones and S. Mansoor, "Predictive Feedforward Control for a Hydroelectric Plant," *IEEE Trans. on Control Syst. Techn.*, vol. 12, no. 6, pp. 921-929, 2004.
- [34] G. A. Munoz Hernandez and D. I. Jones, "MIMO generalized predictive control for a hydroelectric power station," *IEEE Trans. Energy Conv.*, vol. 21, no. 4, pp. 921-929, 2006.
- [35] M. Beus and H. Pandzic, "Application of an adaptive model predictive control algorithm on the Pelton Turbine governor control," *IET Renew. Power Gener.*, vol. 14, issue 10, pp. 1720-1727, 2020.
- [36] Z. Xiao, S. Meng, N. Lu and O. P. Malik, "One-Step-Ahead Predictive Control for Hydroturbine Governor," *Mathem. Problems in Engin.*, vol. 2015.
- [37] T.I. Reigstad and K. Uhlen, "Optimized Control of Variable Speed Hydropower for Provision of Fast Frequency Reserves", *Electr. Power Syst. Res.*, vol. 189, 2020.
- [38] T.I. Reigstad and K. Uhlen, "Variable Speed Hydropower Conversion and Control", *IEEE Trans. Energy Conv.*, vol. 35, no. 1, pp. 386 2020.
- [39] T.I. Reigstad and K. Uhlen, "Nonlinear Model Predictive Control of Variable Speed Hydropower for Provision of Fast Frequency Reserves", *Electr. Power Syst. Res.*, vol. 194, 2021.
- [40] "Smart Grid Laboratory", Accessed on: Nov., 10, 2020. [Online]. Available: [www.fer.unizg.hr/zvne/research/research\\_labs/sglab/laboratory](http://www.fer.unizg.hr/zvne/research/research_labs/sglab/laboratory)
- [41] S.J. Qin and T.A. Badgwell, "A survey of industrial model predictive control technology," *Cont. Engin. Pract.*, vol. 11, issue 7., pp. 733-764, 2003.
- [42] L. Wang, "Model Predictive Control System Design and Implementation Using MATLAB", Springer, 2009, London, UK
- [43] C. Hilderth, "A quadratic programming procedure", *Naval Research Logistics Quarterly*, 1957, 4, pp. 79-85
- [44] K. J. Astrom and R. M. Murray, *Feedback Systems: An Introduction for Scientists and Engineers.*, vol. 36, no. 4. 2008.
- [45] Siemens, "SIMATIC ET200SP CPU 1512SP-1 PN Manual," Manual, 2014. Accessed on: Nov., 24, 2020. [Online]. Available: [https://cache.industry.siemens.com/dl/files/013/90157013/att\\_83463/v1/et200sp\\_cpu1512sp\\_1\\_pn\\_manual\\_en-US\\_en-US.pdf](https://cache.industry.siemens.com/dl/files/013/90157013/att_83463/v1/et200sp_cpu1512sp_1_pn_manual_en-US_en-US.pdf).
- [46] D.I. Jones, S.P. Mansoor, F.C. Aris, G.R. Jones, D.A. Bradely, and D.J. King, "A standard method for specifying the response of hydroelectric plant in frequency-control mode", *Electr. Power Syst. Res.*, vol. 68, issue 1, pp. 19-32, 2004.



**Mateo Beus** (S'17) received his M. Sc. degree in electric power engineering from the University of Zagreb Faculty of Electrical Engineering and Computing, Croatia, in 2014. His employment experience includes working as an engineer at Brodarski Institute Ltd and Eccos Engineering Ltd. Currently, he works as a senior researcher and teaching assistant at the University of Zagreb Faculty of Electrical Engineering and Computing. His research interests include distribution grid automation, integration and management of distributed energy resources, control

of hydro power plants and control & protection of microgrids.



**Hrvoje Pandžić** (SM'2017) received the M.E.E. and Ph.D. degrees from the University of Zagreb Faculty of Electrical Engineering and Computing, Croatia, in 2007 and 2011, respectively. From 2012 to 2014, he was a Postdoctoral Researcher with the University of Washington, Seattle, WA, USA. He is currently an Associate Professor and Head of the Department of Energy and Power Systems with the University of Zagreb Faculty of Electrical Engineering and Computing. He has coordinated multiple European and national research projects as well as commercial

projects for industrial partners. He received numerous awards for his research work, including the award for the highest scientific and artistic achievements in Croatia from the Croatian Academy of Science and Arts. His research interests include power system operation and planning.

### **Publication 3**

M. Beus, F. Banis, H. Pandžić, and N. Poulsen, “Three-level hierarchical microgrid control - model development and laboratory implementation,” *Electric Power System Research*, vol. 189, Dec. 2020, ISSN: 0378-7796. DOI: 10.1016/j.epsr.2020.106758



Contents lists available at ScienceDirect

## Electric Power Systems Research

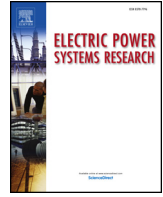
journal homepage: [www.elsevier.com/locate/epsr](http://www.elsevier.com/locate/epsr)

## Three-level hierarchical microgrid control—model development and laboratory implementation

Mateo Beus<sup>a,\*</sup>, Frederik Banis<sup>b</sup>, Hrvoje Pandžić<sup>a</sup>, Niels Kjølstad Poulsen<sup>b</sup><sup>a</sup> Department of Energy and Power Systems, University of Zagreb, Faculty of Electrical Engineering and Computing, Zagreb, Croatia<sup>b</sup> Department of Applied Mathematics and Computer Science, Technical University of Denmark, Lyngby, Denmark

## ARTICLE INFO

## Keywords:

Hierarchical control  
Microgrid  
Model predictive control  
Kalman filter

## ABSTRACT

This paper presents a three-level hierarchical control approach for microgrids in grid-connected mode. The first level optimizes microgrid operation in the long run, e.g. 15 min, with the goal of minimizing microgrid's operating costs. The second level takes part in frequency control in grid-connected microgrids. It utilizes a Model Predictive Controller and Kalman Filter based on available frequency measurements in the microgrid. The third level is the plant level, in which classical controllers are used for tracking optimal set points received from upper two control levels. The developed control scheme is applied to the Smart Grid Lab (SGLab) at the University of Zagreb Faculty of Electrical Engineering and Computing. The findings from this close-to-real-world application are also presented.

### 1. Introduction

The desire to satisfy electricity consumption in a sustainable way has led to an increased share of electricity produced from renewable energy sources (RES). Power systems dominated by RES result in lower conventional power plant capacity that was essential to secure the required flexibility by adapting their production levels. Therefore, in power systems with high share of RES it is essential to provide new sources of flexibility in power systems. As potential solutions to ensure the required flexibility we can rely on demand response (DR) and flexibility available in the distribution network in general. So far, distribution networks were observed as a set of passive consumers able only to withdraw electricity from the transmission network. The increased share of different types of distributed generation (DG) caused a paradigm change and bi-directional power flows. In other words, electricity in modern power systems is frequently injected from the distribution to the transmission network.

Since DGs usually do not have sufficient installed capacity to participate independently in electricity markets, it is crucial to establish a mechanism that enables market-participation of multiple DGs. A possible solution is to enable coupling of multiple DG units into one entity from the grid perspective, i.e. combining them into a microgrid. Microgrids reduce the impact of DGs on distribution networks and thus allow large-scale integration of DGs [1]. Although there is no unique definition of microgrid, it is generally accepted that it is an *integrated*

energy system consisting of interconnected loads and different types of DG, which as an integrated system connected to the grid through the Point of Common Coupling (PCC) can operate in parallel with the grid or in islanded mode [2,3]. Typical microgrid can consist of:

- energy storage, e.g. batteries;
- dispatchable DGs, e.g. small-scale hydro power plants, biogas plants, diesel plants, combined heat and power plants (CHP);
- non-dispatchable RES, e.g. solar power plants, wind power plants;
- dispatchable and non-dispatchable loads.

The main goal of this paper is to develop and validate a hierarchical control scheme for microgrid operation that can serve as a basis for integration of microgrids in electricity markets. The proposed hierarchical control scheme consists of three levels. The first level is an economic problem that minimizes overall operating cost of a microgrid. The second level uses more accurate representation of specific devices within the microgrid and solves real-time control problems on an aggregated level. Finally, the third level is based on classical controllers and serves only for tracking optimal set points received from the upper two control levels. The third control level will not be further analyzed in this paper. Instead, we focus on the first two control levels.

The layout of the paper is as follows. Review of the publications related to the optimization of microgrid operation is elaborated in Section 2. Hierarchical control scheme is introduced in Section 3, while

\* Corresponding author.

E-mail addresses: [mateo.beus@fer.hr](mailto:mateo.beus@fer.hr) (M. Beus), [freba@dtu.dk](mailto:freba@dtu.dk) (F. Banis), [hrvoje.pandzic@fer.hr](mailto:hrvoje.pandzic@fer.hr) (H. Pandžić), [nkpo@dtu.dk](mailto:nkpo@dtu.dk) (N.K. Poulsen).<https://doi.org/10.1016/j.epsr.2020.106758>

Received 4 October 2019; Received in revised form 17 April 2020; Accepted 2 August 2020

Available online 10 August 2020

0378-7796/ © 2020 Elsevier B.V. All rights reserved.

the laboratory setup used to validate the proposed control scheme and simulation results are presented in Section 4. The paper is concluded in Section 5.

## 2. Literature review

In the context of the long-term optimization of microgrid operation (up to one day), which is related to the first control level proposed in this paper, a considerable amount of literature can be found. For instance, in Chen et al. [4] and Marzband et al. [5], the authors formulate Mixed-Integer Nonlinear Optimization Problems (MINLP) used in the context of optimal microgrid operating strategy. In both cases, MINLP optimization problems are used as energy management system (EMS) control tools with the main goal of performing optimal operation and scheduling of microgrids. In Zhu et al. [6], a coordinated two-level control approach is developed for microgrid management. Both control levels are based on the receding horizon concept. The main task of the lower control level is to maintain the power output from the RES constant during short periods. On the other hand, the upper control level is used to mitigate severe fluctuations of the power output from convectional generators caused by balancing the output of intermittent sources. In order to fulfill their tasks, both control levels rely on the use of battery storage.

The second control level related to frequency primary reserve provision in grid-connected mode is based on Model Predictive Control (MPC) approach. The body of literature on MPC as a control approach in power system operation problems is very broad. In this context, MPC algorithm is usually formed in a way that typical unit commitment or dynamic economic dispatch problem is extended with the receding horizon approach. In Parisio et al. [7,8], the authors apply an MPC approach based on MILP to the problem of efficiently optimizing microgrid's operations while satisfying time-varying requests and operation constraints. In Xie et al. [9], the authors use an MPC approach to solve a multi-objective economic/environmental dispatch problem in a power system with high share of RES. The conclusion is that the MPC algorithm is able to minimize the generation costs by directly dispatching the output from RES in order to compensate for temporal load variations over the time horizon. Further, in Xia et al. [10], the authors apply an MPC algorithm to solve a dynamic economic dispatch problem with the main goal of minimizing the microgrid operating costs. In addition, the difference in formulations between the optimal control dynamic dispatch based on control theory and the dynamic economic dispatch based on optimization theory is demonstrated. In Qi et al. [11,12], a supervisory control system based on an MPC algorithm is developed for optimal management and operation of a hybrid wind-solar power plant. The MPC algorithm calculates optimal power set points for the solar and wind subsystems at each sampling time while minimizing the cost function. These set points are then sent to two local controllers responsible for tracking optimal set points received from the supervisory control system.

Microgrids are considered to be complex energy systems since their control requirements involve different control approaches and different time scales. For instance, voltage and frequency control tasks have the time scales of seconds, while microgrid unit commitment problems have the time scale of hours. In that regard, different control structures, i.e. hierarchical, distributed and decentralized, have been analysed in order to find a suitable solution for microgrid's control requirements. Hierarchical control approach has shown as a most promising solution for microgrid's complex control requirements. As a starting point for the development of the control structure introduced in this paper the research on the hierarchical control in microgrids in Bidram and Davoudi [13], Vandoorn et al. [14], Feng et al. [15] has been used. It should be emphasized that the main strength of hierarchical control approach introduced in this paper compared to the previous solutions lies in the application of co-simulation framework that ensures scalability and flexibility of the control structure. In [13], the authors review the

hierarchical control strategies applied to microgrids. The hierarchical control structure introduced in this paper consists of primary, secondary and tertiary control levels. The goal of the primary control level is to stabilize the voltage and frequency, the secondary control level is responsible for compensating voltage and frequency variations caused by the primary control level, while the third level is responsible for power flow control through PCC and optimal operation in grid-connected operating mode. In a similar fashion, in Vandoorn et al. [14] the authors analyze a three-level hierarchical control structure that can be implemented in islanded microgrids. In addition, this paper provides an overview of the control strategies related to the reserve provision by DG units, loads, and storage. In [15], the authors provide a comprehensive comparison between hierarchical control structures and distributed control structures for microgrids. The main advantage of hierarchical control compared to distributed control can be seen in the use of the optimal solution since hierarchical control integrates a centralized EMS. This implies that in the case of hierarchical control, computational complexity is higher due to the use of more advanced optimization algorithms compared to the distributed control. The main disadvantage of this is that hardware platform in the hierarchical approach requires more powerful computers. Although the communication network is important for both control approaches, the main advantage of the distributed approach is that any single point failure in the communication of the control system would not have severe impact on the normal system operation. An overview of the main features of the hierarchical and distributed control approaches is given in Table 1.

## 3. Hierarchical control formulation

The hierarchical control approach designed in this paper consists of three levels illustrated in Fig. 1. The first-level controller is responsible for the long-term behavior of the microgrid and it is not influenced by the transient behavior of the fast dynamics. The second-level controller is in charge of frequency primary reserve provision in grid-connected mode; third level controllers are responsible for tracking set points received from the upper two control levels.

### 3.1. Upper optimization level — EMS

Here, we introduce the dynamic economic dispatch formulation used in the first control level. Parameters and variables used in the formulation are described in Table 2. The main goal of this control level is to minimize the total operating costs while satisfying the demand and other technical constraints over a prediction horizon.

#### 3.1.1. Cost function

The goal is to optimize the following cost function:

$$\min \sum_{t=1}^T \sum_{g \in \mathcal{G}} c_1 p_g(t) + c_2 s(t) \quad (1)$$

where the first term represents the cost associated with energy production from DGs and the second term represents cost/profit from the interaction with the utility grid. In addition,  $t$  is a time instant and  $T$  is

**Table 1**

Comparison of hierarchical and distributed control approach for microgrid [15].

Features	Hierarchical control	Distributed control
Economics	Optimal	Suboptimal
Control system reliability	Limited reliability	Reliable
Design complexity	Complex	Simple
Scalability	High	Low
Computational complexity	High	Low
Hardware platform	Powerful computer	Embedded controller
Communication bandwidth	Low	High



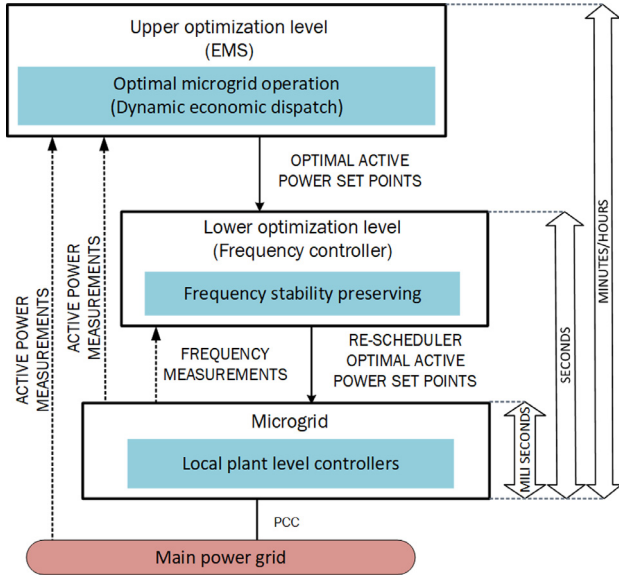

Fig. 1. Proposed hierarchical control levels of a microgrid.

**Table 2**  
Parameters and variables in the upper optimization level.

Parameters	Description
$N_g$	Number of DG units
$N_l$	Number of dispatchable loads
$BL$	Total consumption level of non-dispatchable loads [kW]
$p_g^{\text{MIN}}$	Minimum power level of a DG unit [kW]
$p_g^{\text{MAX}}$	Maximum power level of a DG unit [kW]
$RU_g^{\text{MAX}}$	Ramp up limit of a DG unit [kW/h]
$RD_g^{\text{MAX}}$	Ramp down limit of a DG unit [kW/h]
$P_{\text{RES}}$	Total power production from RES [kW]
$L_t$	Forecasted power level of a dispatchable load [kW]
$p_g^{\text{INIT}}$	Active power measurements of DG units [kW]
$c_1$	Production cost [EUR/kWh]
$c_2$	Energy price [EUR/kWh]
Variables	Description
$D_l$	Dispatchable load consumption level [kW]
$p_g$	Power level of a DG unit [kW]
$s$	Power exchanged with the utility grid [kW]

the length of the prediction horizon.

### 3.1.2. Operational constraints

Balance between the production and the consumption must be satisfied at each sampling instant  $t$ , so the following equality constraint is defined:

$$\sum_{g=1}^{N_g} p_g(t) + p^{\text{RES}} \geq \sum_{l=1}^{L_c} D_l(t) + BL(t) \quad (2)$$

where the first term represents production level from the dispatchable DGs at time instant  $t$  and the second term represents total production level from non-dispatchable RES units in the microgrid for the entire prediction horizon. The first term on the right-hand side of constraint (2) represents consumption level of non-critical dispatchable loads at time instant  $t$ , while the second term represents consumption level of critical non-dispatchable loads at time instant  $t$ .

In addition, each DG unit needs to satisfy the following technical constraints:

$$p_{g,t}^{\text{MIN}} \leq p_{g,t} \leq p_{g,t}^{\text{MAX}} \quad (3)$$

$$p_{g,t+1} - p_{g,t} \leq RU_g^{\text{MAX}} \quad (4)$$

$$p_{g,t_1} - p_g^{\text{INIT}} \leq RU_g^{\text{MAX}} \quad (5)$$

$$p_{g,t-1} - p_{g,t} \leq RD_g^{\text{MAX}} \quad (6)$$

$$p_g^{\text{INIT}} - p_{g,t_1} \leq RD_g^{\text{MAX}} \quad (7)$$

with  $g=1, \dots, N_g$ . Terms (3)–(7) constrain production level,  $p_{g,t}$  by minimum and maximum output limits,  $p_{g,t}^{\text{MIN}}$  and  $p_{g,t}^{\text{MAX}}$ , as well as ramp up and ramp down rates,  $RU_g^{\text{MAX}}$  and  $RD_g^{\text{MAX}}$ , of the DG units. Parameter  $p_g^{\text{INIT}}$  represents the power output at  $t = 0$ .

Since dispatchable loads have the possibility to provide DR, an additional constraint is introduced below to ensure that the total energy of the consumer does not change over the operating horizon.

$$\sum_{t=1}^T \sum_{l=1}^{L_c} D_{l,t} = \sum_{t=1}^T \sum_{l=1}^{L_c} L_{l,t} \quad (8)$$

In (8),  $L_{l,t}$  represents forecasted load profiles for each load, while  $D_{l,t}$  represents set points sent to local load controllers.

## 3.2. Lower optimization level — frequency controller

### 3.2.1. Controller model

The frequency control problem at the aggregated system level is commonly stated using the swing equation as a means to describe the inertia of the system [20,21]. In the linear approximation it can be formulated as:

$$\frac{d}{dt} \Delta f_t = -\frac{D_{\text{load}}}{2H_t} \Delta f_t + \frac{1}{2H_t} \Delta P_t^m \quad (9)$$

Here,  $\Delta f$  is the frequency deviation from the nominal frequency,  $H_t$  is the inertia based supply time and  $D_{\text{load}}$  is the load damping coefficient. Notice that  $H_t$  may be time varying [27]. The swing equation expresses the approximated inertia with respect to a single center of gravity.

$\Delta P^m$  is the mechanical power balance within the considered grid:

$$\Delta P_t^m = P_t^+ - P_t^- \quad (10)$$

The power injections  $P_t^+$  and extractions  $P_t^-$  are nonlinear functions and must be linearized in order to use them within linear MPC. The overall system is then linearized around a chosen stationary point and discretized using zero-order hold approach. The linearized discrete time system model can be stated as:

$$\Delta x_{i,k+1} = A_{i,k} \Delta x_{i,k} + B_{i,k} \Delta u_{i,k} + G_{i,k} \Delta d_{i,k} + r_{i,k} + w_i \quad (11a)$$

$$\Delta y_{i,k} = C \Delta x_{i,k} + v_i \quad (11b)$$

See [22] and [29] for further details of this formulation. Here,  $\Delta u_{i,k}$  are the control inputs at discrete time instant  $i$  and optimization horizon instant  $k$ . Similarly, we have states  $\Delta x_{i,k}$  and disturbance inputs  $\Delta d_{i,k}$ . In the simplest form,  $\Delta y_{i,k}$  equals the state of the swing equation. Then, this is a multiple-input single-output (MISO) system.

### 3.2.2. Model predictive controller

Let the perturbation variables  $\Delta y_{i,k}$ ,  $\Delta x_{i,k}$ ,  $\Delta u_{i,k}$ ,  $\Delta d_{i,k}$  in (11) be substituted by  $y_k$ ,  $x_k$ ,  $u_k$ ,  $d_k$  respectively. Furthermore,  $x_k$  and  $d_k$  are estimates and therefore denoted as  $\hat{x}_k$  and  $\hat{d}_k$  respectively. The quadratic and convex controller objective is then stated as:

$$\min_{u,k} J = \|\Phi_x \hat{x}_{k|k} + \Gamma_u u_k + \Gamma_d \hat{d}_{k|k} + \Phi_r r_{k|k}\|_{W_z}^2 + \|u_k\|_{W_{\Delta u}}^2 \quad (12)$$

$$\text{s.t. } u_k^{\text{MIN}} \leq u_k \leq u_k^{\text{MAX}} \quad (13)$$

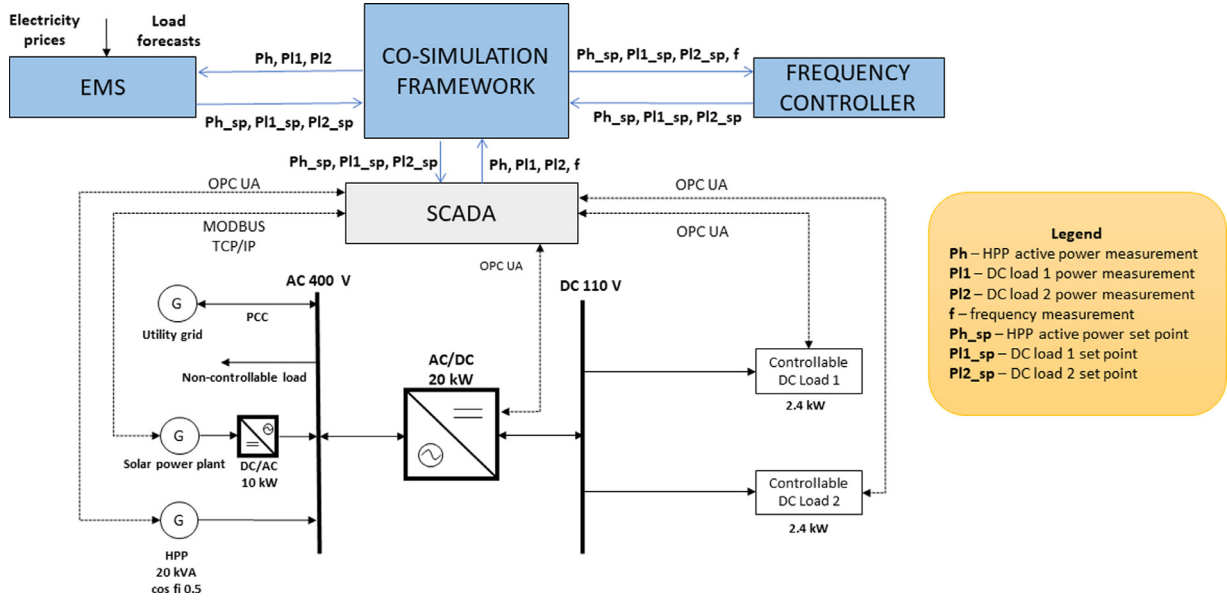

Fig. 2. Structure of the microgrid in the SGLab.

$$\Delta u_k^{\text{MIN}} \leq \Delta u_k \leq \Delta u_k^{\text{MAX}} \quad (14)$$

$$G_k u_k \leq h_k \quad (15)$$

$\Phi_x$  are Markov parameters (MP) of the free system response.  $\Gamma_u, \Gamma_d$  are MP of the forced system response with respect to the control decisions and system disturbances respectively. The MP implement the linear prediction model.  $\Phi_r$  are MP with respect to the dynamics residual and are non-zero when the controller reference does not satisfy the model dynamics [29].

Notice that  $\Gamma_d$  entails modeled disturbance dynamics and approximated residual disturbance process dynamics. The state of this residual process is estimated using the augmented state observer denoted in (18) below.

### 3.2.3. State observer

We estimate the state estimate  $\hat{x}$  and residual disturbance estimate  $\hat{d}_r$ . Using formulations given in Pannocchia and Rawlings [23,24], we have the augmented system model:

$$A_{i,o} = \begin{bmatrix} A_i & B_{i,d} \\ 0 & I \end{bmatrix} \quad (16)$$

$$B_{i,o} = \begin{bmatrix} B_i \\ 0 \end{bmatrix} \quad (17)$$

$B_{i,d}$  are dynamics associated with the residual error  $\hat{d}_r$ . As these are uncertain they have to be approximated.

Following the notation in [30, P. 44] we can state the prediction step:

$$\hat{x}_k^- = A_{i,o} \hat{x}_{k-1} + B_{i,o} u_{k-1} \quad (18a)$$

$$P_k^- = A_{i,o} P_{k-1} A_{i,o}^T + Q_k \quad (18b)$$

and following update step:

$$K_k = P_k^- C_i^T (C_i P_k^- C_i^T + R_k)^{-1} \quad (18c)$$

$$P_k = (I - K_k C_i) P_k^- \quad (18d)$$

$$\hat{x}_k = \hat{x}_k^- + K_k (y_k - C_i \hat{x}_k^-) \quad (18e)$$

See also [22] and [28].

## 4. Implementation of hierarchical control for experimental microgrid

### 4.1. Laboratory setup

The microgrid test site consists of the following units [16,17]:

- Hydro power plant – total rated power of the plant is 11.8 kW and power factor is 0.5. The plant represents a DG in the simulation;
- Solar power plant – total installed capacity of the solar power plant is 10 kW. The plant is connected to the AC part of the microgrid using a three-phase inverter;
- Load bank of resistors – maximum power of 8 kW equally distributed over three phases. The load is non-dispatchable and represents critical load in the simulation;
- Bi-directional converter – rated power of 20 kW and it is used to couple the AC and DC parts of the microgrid;
- Two DC electronic loads – each has rated power of 2.4 kW and the loads are fully controllable.

In Fig. 2 it is depicted that all the components of the microgrid are integrated into a Supervisory and Control Data Acquisition System (SCADA) called PROZA NET [18]. Although this SCADA system supports different types of communication protocols, i.e. IEC 104, IEC 61850, Modbus RTU and TCP/IP, OPC, in this setup only OPC UA and Modbus TCP/IP communication protocols were used to integrate the microgrid's components. Further, a central component that couples all three control levels is a flexible smart grid co-simulation framework MOSAIK [19], whose main goals are to coordinate execution of all controllers and to control data exchange between controllers. Therefore, MOSAIK is used to orchestrate when the controller at each control level will be called and how often the data among them will be exchanged. An additional strength of this approach can be seen in that existing SCADA infrastructure is integrated within MOSAIK as an additional component. Therefore, minimal requirements are necessary in terms of upgrades of communication and control infrastructure to integrate the proposed hierarchical control solution.

EMS and frequency controller (FC) are being directly connected through MOSAIK, while the local plant level controllers are integrated into the hierarchical control structure through SCADA that is connected with MOSAIK using a gateway based on TCP client-server communication. In that regard, MOSAIK represents a TCP client and SCADA is

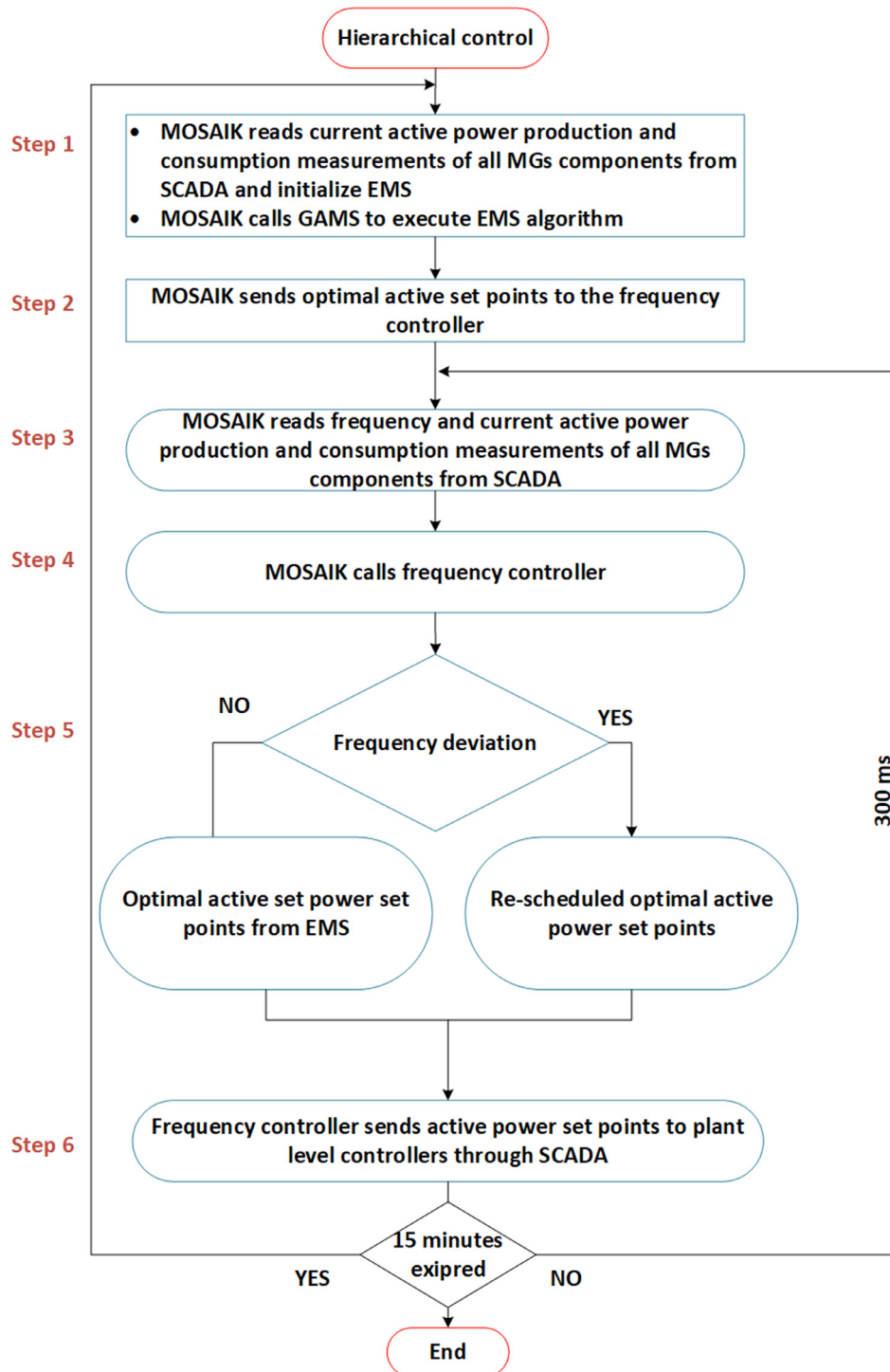

Fig. 3. Hierarchical control flowchart.

a TCP server.

Working principle of the hierarchical control approach is illustrated in Fig. 3. The entire operating procedure consists of six steps. Step 1 is conducted every 15 min. In this step, MOSAIK initializes and executes the EMS algorithm in General Algebraic Modeling System (GAMS). Results of the EMS are optimal active power set points for each controllable unit for the next 15 min. In Step 2, MOSAIK sends optimal active power set points to the FC. In Step 3, MOSAIK reads frequency and current active power measurements of all microgrid’s components from SCADA and forwards those measurements to the FC. In Step 4, MOSAIK calls the FC to execute. In Step 5, if frequency measurement

does not deviate from the nominal frequency, FC will send through SCADA optimal active power set points received from MOSAIK in Step 2 to the local plant-level controllers. In case of frequency deviations, FC will send rescheduled optimal active power set points to the local plant-level controllers in order to provide primary reserve in the grid connected mode. In addition, Steps 3–6 are cyclically executed every 300 ms.

#### 4.2. Simulation results

In this section we present two deterministic simulation experiments

**Table 3**  
Load profiles.

Time	$L_1$ [kW]	$L_2$ [kW]
$t_1$	0.4	1.1
$t_2$	0.7	1.2
$t_3$	0.8	0.8
$t_4$	0.8	0.5
$t_5$	0.6	1.1
$t_6$	1.0	1.0
$t_7$	0.9	0.7
$t_8$	1.2	1.0
$t_9$	1.2	1.0
$t_{10}$	0.8	0.8
$t_{11}$	1.5	0.6
$t_{12}$	1.7	0.5
$t_{13}$	1.2	0.5
$t_{14}$	1.0	0.5
$t_{15}$	0.4	1.3

demonstrating the functionality of the proposed microgrid hierarchical control setup. In both experiments the microgrid operates in the grid-connected mode. The microgrid topology shown in Fig. 2 is used.

During both experiments, the microgrid is operated with the same consumption profiles of the dispatchable loads. The dispatchable loads in both experiments have the ability to provide DR which is modeled in a way that the total energy consumption does not change over the operating horizon. Table 3 shows load profiles for dispatchable loads.

The presented experiments differ in the choice of input reference deviation penalization:

$$\text{Experiment 1 } \tilde{W}_{\Delta u} = \begin{bmatrix} 1 & 0 & 0 \\ 0 & 5 & 0 \\ 0 & 0 & 5 \end{bmatrix}$$

$$\text{Experiment 2 } \tilde{W}_{\Delta u} = \begin{bmatrix} 4 & 0 & 0 \\ 0 & 5 & 0 \\ 0 & 0 & 5 \end{bmatrix}$$

$\tilde{W}_{\Delta u}$  is hereby a single distinct element in the overall deviation penalization matrix  $W_{\Delta u}$ . Consequently, the hydro power plant is given higher degrees of freedom in terms of deviations away from the input reference than the two dispatchable loads. This is true for both experiments, however in *Experiment 1* deviations of the hydro power plant are penalized less.

Both experiments are conducted with a 15-minute prediction horizon and a time step of 1 min, while the FC controller uses 20-seconds prediction horizon. Since the microgrid in both experiments operates in grid-connected mode, the main goal of EMS is to minimize power flows

to/from the utility grid, while the main purpose of FC is to provide primary reserve. Hydro power plant, as the only dispatchable DG in both experiments, has ramp up/down limit 1.5 kW/min, maximum power 11.5 kW and minimum production level 1 kW. Base load value in both experiments is set to 3 kW. The cost of electricity generated by the hydro power is  $c_1 = 0.25$  EUR/kWh [25], while the electricity price  $c_2$  is 0.31 EUR/kWh during the first seven minutes and 0.21 EUR/kWh during the rest of the simulation time [26]. During the first experiment, solar power plant production level was 6.28 kW, while during the second experiment solar power plant production level was 2.98 kW.

Simulation results of both experiments are shown in Figs. 4 and 5. FC in both cases follows the set points received from the EMS. In *Experiment 1*, the lower reference penalization value for the hydro power plant causes the hydro power plant references generated by the FC to deviate more from the references given by the EMS as compared to the second experiment. In Figs. 4 and 5 the dashed lines in the input space represent FC references, while the solid lines represent the references received from the EMS.  $U_0$  represents the hydro power plant reference,  $U_1$  represents reference for the dispatchable load 1 and  $U_2$  for dispatchable load 2. Further,  $y_m$  represents frequency measurements, while  $\hat{y}$  represents frequency estimations. In the lower graph in Fig. 4, the largest deviation occurred at time 16:05 when, instead of reducing the output of the hydro power plant (blue line) the FC actually increased the power (dashed blue line).

This is because the negative frequency deviation at the same time (see the first graph in Fig. 4) caused the FC to increase the output of the hydro power plant in order to increase the frequency (input reference deviation penalization equal to 1).

On the other hand, the dispatchable loads ( $U_1$  and  $U_2$ ) strictly follow the given set points from the EMS as they do not take part in frequency regulation (input reference deviation penalization equal to 5). In Fig. 5, which shows the result for *Experiment 2*, the hydro power plant output deviates much less because its input reference deviation penalization is increased to 4, while the loads behave the same way as in *Experiment 1*.

## 5. Conclusion

The main idea of this paper was to present a three-level hierarchical control approach that can be applied to microgrids. The first control level is based on dynamic economic dispatch algorithm and its main purpose is to optimize microgrid operation in the long-run with the goal of minimizing microgrid's operating costs. The second control level optimizes the aggregated system frequency control problem. Using a Model Predictive Control formulation and extended Kalman filter, both the constraints and the unknown disturbances are accounted for based

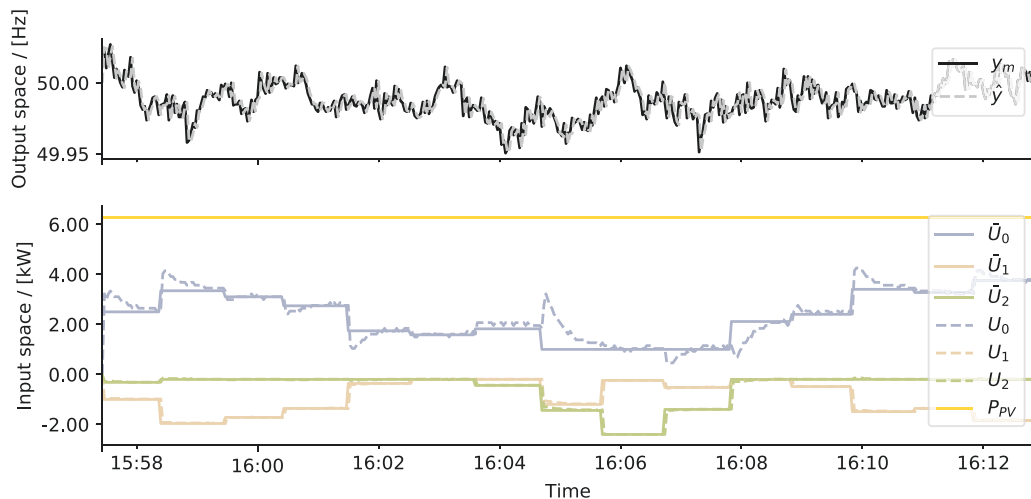

Fig. 4. Results of *Experiment 1* (deviations of the hydro power plant are penalized less compared to *Experiment 2*).

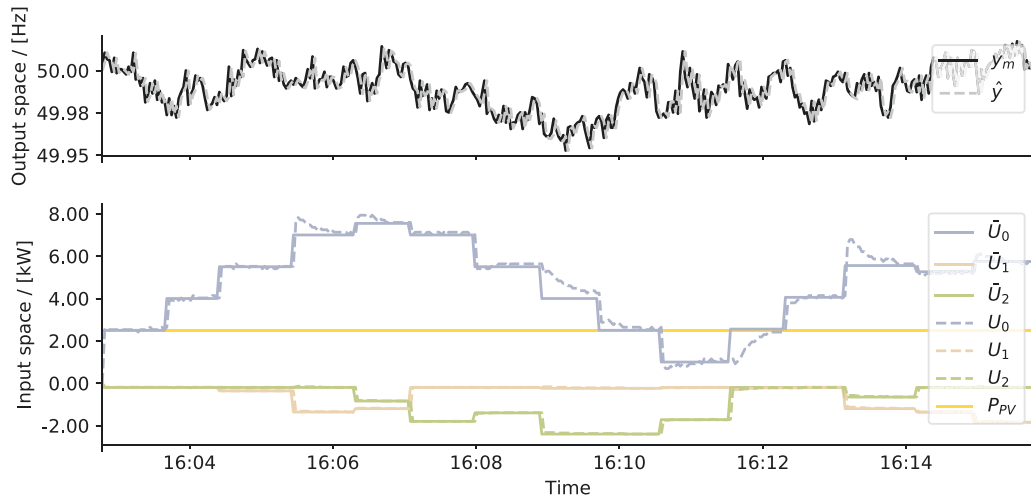

Fig. 5. Results of *Experiment 2* (deviations of the hydro power plant are penalized more compared to *Experiment 1*).

on frequency measurement in the microgrid. The third level is the plant level, in which classical controllers are used for tracking optimal set points received from upper two control levels.

The functionality of this control approach has been tested on the laboratory microgrid at the SGLab at the University of Zagreb Faculty of Electrical Engineering and Computing. Experimental results have shown the effectiveness of this control approach in grid-connected mode.

Further research will be focused on the experimental validation of the proposed approach in the islanded mode. In that regard, additional components will be included in the microgrid, such as battery storage or additional photovoltaic capacity.

#### Declaration of Competing Interest

The authors declare that they have no known competing financial interests or personal relationships that could have appeared to influence the work reported in this paper.

#### Acknowledgments

This work has been supported in part by the H2020 ERA Net Smart Grids+ project *microGRID Positioning – uGRIP*, as well as by the Croatian Science Foundation and European Union through the European Social Fund under project *Flexibility of Converter-based Microgrids – FLEXIBASE* (PZS-2019-02-7747).

#### References

- [1] T.S. Ustun, C. Ozansoy, A. Zayegh, Recent developments in microgrids and example cases around the world—A review, *Renew. Sustain. Energy Rev.* 15 (8) (2011) 4030–4041.
- [2] R.H. Lasseter, P. Paigi, Microgrid: a conceptual solution, *Proceeding of IEEE 35th Annual Power Electronics Specialist Conference, Aachen*, (2004).
- [3] N. Hatzigiorgiou, H. Asano, R. Irvani, C. Marnay, Microgrids, *IEEE Power Energy Mag.* 5 (4) (2007) 78–94.
- [4] Y.H. Chen, S.Y. Lu, Y.R. Chang, T.T. Lee, M.C. Hu, Economic analysis and optimal energy management models for microgrid systems: a case study in Taiwan, *Appl. Energy* 103 (2013) 145–154.
- [5] M. Marzband, A. Sumper, J.L. Dominguez-Garcia, R. Gumara-Ferret, Experimental validation of a real time energy management system for microgrids in islanded mode using a local day-ahead electricity market and MINLP, *Energy Convers. Manag.* 76 (2013) 314–322.
- [6] D. Zhu, R. Yang, G. Hug-Glanzmann, Managing microgrids with intermittent resources: two-layer multi-step optimal control approach, *IEEE North American Uoer Uymposium*, (2010).
- [7] A. Parisio, E. Rikos, L. Glielmo, A model predictive control approach to microgrid operation optimization, *IEEE Trans. Control Syst. Technol.* 22 (5) (2014) 1813–1827.
- [8] A. Parisio, E. Rikos, G. Tzamalīs, L. Glielmo, Use of model predictive control for experimental microgrid optimization, *Appl. Energy* 115 (2014) 37–46.
- [9] L. Xie, M.D. Ilic, Model predictive economic/environmental dispatch of power systems with intermittent resources, *IEEE Power and Energy Society General Meeting, Calgary*, (2009).
- [10] X. Xia, J. Zhang, A. Elaiw, A model predictive control approach to dynamic economic dispatch problem, *IEEE PowerTech Conference, Bucharest(2009)*.
- [11] W. Qi, J. Liu, X. Chen, P.D. Christofides, Supervisory predictive control of stand-alone wind/solar energy generation systems, *IEEE Trans. Control Syst. Technol.* 19 (1) (2011) 199–207.
- [12] W. Qi, J. Liu, P.D. Christofides, Supervisory predictive control for long-term scheduling of an integrated wind/solar energy generation and water desalination system, *IEEE Trans. Control Syst. Technol.* 20 (2) (2012) 504–512.
- [13] A. Bidram, A. Davoudi, Hierarchical structure of microgrids control system, *IEEE Trans. Smart Grid* 3 (4) (2012) 1963–1976.
- [14] T.L. Vandoor, J.C. Vasquez, J. de Kooning, J.M. Guerrero, L. Vandeveld, Microgrids: hierarchical control and an overview of the control and reserve management strategies, *IEEE Ind. Electron. Mag.* 7 (4) (2013) 42–55.
- [15] X. Feng, A. Shekhar, F. Yang, R.E. Hebner, P. Bauer, Comparison of hierarchical control and distributed control for microgrid, *Electr. Power Compon. Syst.* 45 (10) (2017) 1043–1056.
- [16] University of Zagreb faculty of electrical engineering and computing. Smart Grid Laboratory. [http://www.fer.unizg.hr/zvne/research/research\\_labs/sglab/laboratory](http://www.fer.unizg.hr/zvne/research/research_labs/sglab/laboratory).
- [17] I. Kuzle, J. Havelka, H. Pandzic, T. Capuder, Hands-on laboratory course for future power system experts, *IEEE Trans. Power Syst.* 29 (4) (2014) 1963–1971.
- [18] PROZA NET. [https://www.koncar-ket.hr/en/upravljajcki-centri/it-rjesenja/#proza\\_net\\_integration\\_platform](https://www.koncar-ket.hr/en/upravljajcki-centri/it-rjesenja/#proza_net_integration_platform).
- [19] MOSAIK. <https://www.offis.de/en/applications/energy/co-simulation-of-multi-modal-energy-systems.html>.
- [20] Kundur, *Power System Stability and Control*, McGraw-Hill, 1994.
- [21] H. Bevrani, *Robust Power System Frequency Control*, Springer International Publishing, Cham, 2014.
- [22] N.R. Kristensen, H. Madsen, Jørgensen and sten bay, parameter estimation in stochastic grey-box models, *Automatica* 40 (2) (2004) 225–237, <https://doi.org/10.1016/j.automatica.2003.10.001>.
- [23] G. Pannocchia, J.B. Rawlings, Disturbance models for offset-free model-predictive control, *AIChE J.* 49 (2) (2003) 426–437.
- [24] G. Pannocchia, J.B. Rawlings, Robustness of MPC and disturbance models for multivariable ill-conditioned processes, *TWMCC, Texas-Wisconsin Modeling and Control Consortium*, (2001).
- [25] International renewable energy agency. “Renewable Energy Technologies: Cost Analysis Series - Hydropower”, [http://www.irena.org/documentdownloads/publications/re\\_technologies\\_cost\\_analysis-hydropower.pdf](http://www.irena.org/documentdownloads/publications/re_technologies_cost_analysis-hydropower.pdf).
- [26] Eurostat. [https://ec.europa.eu/eurostat/statistics-explained/index.php/Electricity\\_price\\_statistics#Electricity\\_prices\\_for\\_household\\_consumer](https://ec.europa.eu/eurostat/statistics-explained/index.php/Electricity_price_statistics#Electricity_prices_for_household_consumer).
- [27] A. Ulbig, T.S. Borsche, G. Andersson, Impact of Low Rotational Inertia on Power System Stability and Operation, *IFAC Proc. Vol.* 47 (3) (2014) 7290–7297. [Online]. Available: <http://www.sciencedirect.com/science/article/pii/S1474667016427618>
- [28] J.B. Rawlings, D.Q. Mayne, M.M. Diehl, *Model Predictive Control: theory, Computation, and Design*, second ed., Nob Hill Publishing, Madison, Wisconsin, 2017. OCLC: 1020170256
- [29] S. Gros, M. Zanon, R. Quirynen, A. Bemporad, M. Diehl, From linear to nonlinear MPC: bridging the gap via the real-time iteration, *Int. J. Control* 93 (1) (2020) 62–80.
- [30] R. Moreno-Díaz, *Computer Aided Systems Theory - EUROCAST 2011: 13th International Conference, Las Palmas de Gran Canaria, Spain, February 6-11, 2011; revised selected papers. Pt. 2:...* ser.Lecture Notes in Computer Science, Springer, Heidelberg, 2012. OCLC: 830761735

#### **Publication 4**

M. Beus and H. Pandžić, “Application of Model Predictive Control Algorithm on a Hydro Turbine Governor Control,” in *2018 Power Systems Computation Conference (PSCC)*, IEEE, Jun. 2018, pp. 1–7. DOI: 10.23919/PSCC.2018.8442594

# Application of Model Predictive Control Algorithm on a Hydro Turbine Governor Control

Mateo Beus, Hrvoje Pandžić  
Department of Energy and Power Systems  
University of Zagreb Faculty of Electrical Engineering and Computing  
Zagreb, Croatia  
{mateo.beus,hrvoje.pandzic}@fer.hr

**Abstract**—Operation of the most turbine governors currently in use is based on Proportional-Integral-Derivative (PID) controllers. The use of PID controllers is widespread primarily because of their extensive applicability to a variety of single-input-single-output (SISO) applications. However, classical PID controllers have disadvantages, e.g. resiliency to disturbances and uncertainties, as well as integral windup. In this regard, a controller based on the Model Predictive Control (MPC) algorithm, which is known as a Generalized Predictive Control (GPC), is developed and applied to a linearized SISO model of the hydropower plant. The response of the system with constrained GPC is compared to the classical PI controller. The main conclusion is that GPC provides better performance than the classical PI regulator.

**Index Terms**—hydraulic turbine dynamic model, linear model, load frequency control, predictive control, turbine governors

## I. INTRODUCTION

Proportional-Integral-Derivative (PID) controllers are widespread in turbine governor applications [1]. Although they have many advantages, such as easy implementation, the main disadvantage of PID controllers is a fairly low robustness. If the system parameters cannot be precisely estimated, the designed PID controller may not be resilient to uncertainties and disturbances. Another important disadvantage of PID controller is integral windup, i.e. the process of accumulating the integral component beyond the saturation limits of actuators. More advanced types of controllers, such as controllers based on Generalized Predictive Control (GPC) algorithm, offer an alternative approach to control hydro turbines, avoiding problems associated with PID controllers.

Each turbine governor consists of two automatic controllers: a speed controller and a frequency/load controller [2]. During the start-up sequence, the speed controller is used, while the breaker is open. Once the generator is synchronized to the grid, the frequency/load controller takes over the control.

Generally speaking, the application of Model Predictive Control (MPC) for load/frequency control of hydropower plants is not widespread as for controlling thermal power plants and wind power plants. In [3], the authors analyze applicability of industrial MPC to thermal power plants. Dynamic Matrix Control (DMC) was applied on a detailed plant simulator, which is used for operator training and controllers tuning. The results have shown a great potential of MPC in terms of economical savings, reduction of pollutants and

improved flexibility. In [4], the authors applied MPC to a superheater steam temperature control in the coal-fired thermal power plant. An MPC controller is compared with a classical PID controller and the obtained results showed that the steam temperature controlled by the MPC controller is more stable.

Application of MPC strategy to a large gas turbine power plant is examined in [5] order to improve plant thermal efficiency and load/frequency control capabilities. Simulation results have shown significant improvements in the frequency variations and load following capability. This has led to improvements in the overall combined cycle thermal efficiency of 1.1%. A constrained MPC-based controller for the purpose of wind turbine control was presented in [6]. The performance of the MPC controller with constraint handling is compared with the PI controller with integrator anti-windup. Simulation results have shown that MPC strategy ensures that soft constraints are satisfied to the greatest possible extent while at the same time hard constraints are not violated. The implications of formulating a single control law that governs the entire wind speed range of operation for a wind turbine are discussed in [7]. In this paper, the authors analyzed a controller based on a nonlinear MPC and that includes wind speed predictions in the prediction horizon.

The main reason why MPC is analyzed and applied more often to control of thermal power plants than to control of hydropower plants is because hydropower plants have faster dynamic behavior. In this paper the frequency/load controller is analyzed. The analyzed plant consists of a single tunnel drawing water from an upper reservoir into a manifold, which splits the flow into two groups of two penstocks. Each penstock feeds a single unit to produce electricity. Produced active power of each unit is regulated by controlling the flow of water using a guide vane at each turbine. Each turbine drives a synchronous generator and the amount of active power which is fed into the grid is regulated by the PI feedback loops or GPC, which change the guide vane angle, thus regulating the flow of water into the turbine. Unit 1 is a 4.8 MW Francis turbine, while Units 2-4 are identical 6.4 MW Francis turbines. For simulation purposes in this paper, a linearized SISO model of Unit 3 is used. A schematic representation of hydropower plant Miljacka is given in Fig. 1, while the basic parameters of the plant used to create the simulation model are listed in Table I [8].

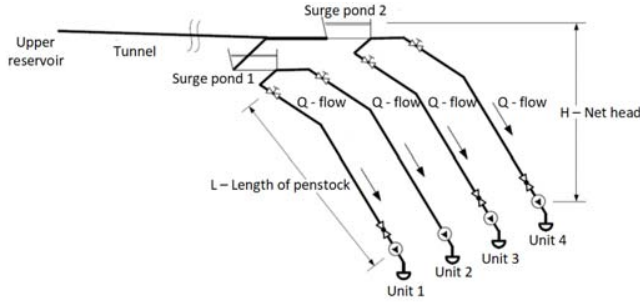

Figure 1. Schematic diagram of hydropower plant Miljacka.

TABLE I  
HYDROPOWER PLANT MILJACKA PARAMETERS.

Number of units	4
Type of turbines	Francis
Rated power - Unit 1	4.8 MW
Rated power - Units 2-4	6.4 MW
Rated speed	500 rpm
Rated flow/unit	$7.4 \text{ m}^3 \text{ s}^{-1}$
Net head	103 m
Length of penstock	168 m
Penstock diametar	1.6 m

Nowadays, controllers for turbine governor applications are usually based on Single-Input-Single-Output (SISO) linearized models. The main issue with this is that hydropower plants are highly nonlinear systems. The two main characteristics of hydropower plants are nonlinear relationship between guide vane angle, volume flow of water and mechanical power, and Non-Minimum-Phase (NMP) behavior [9]. This implies that the parameters of the linearized model vary significantly across plant's operating range. Therefore, a fixed parameter PID structure controller can only be optimal at operating point chosen during the controller design. In this paper, GPC algorithm also uses linearized SISO model as controller's internal model and for process simulation purposes.

Main intention of this paper is to compare the proposed predictive controller with the classical PI controller using an identical SISO linearized model.

The rest of the paper is organized as follows. The plant model is explained in Section II. Unconstrained and constrained GPC algorithm formulation is explained in Section III, while simulation results and discussion are provided in Section IV. The paper is concluded in Section V.

## II. SISO PLANT MODEL

The analyzed plant model is presented in Fig. 2.

Main components of the model are:

- guide vanes and their hydraulic actuator transfer function,
- penstock transfer function,
- Francis turbine transfer function.

A simplified transfer function that describes the penstock dynamic behavior is [10]:

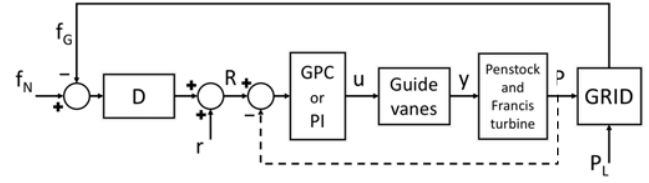

Figure 2. Subsystems of the hydropower plant.

$$\frac{\Delta h_{TC}(s)}{\Delta q_T(s)} = -T_w s, \quad (1)$$

where  $h_{TC}$  is the dynamic pressure at the end of the penstock (head),  $q_T$  is the flow of water through the turbine,  $T_w$  is the water starting constant,  $\Delta$  stands for deviation, and  $s$  denotes the Laplace domain.

Francis turbine model is expressed by (2) and (3) that describe flow of water through turbine and mechanical power output [11]:

$$q_T = y \sqrt{h_{TC}} \quad (p.u.), \quad (2)$$

$$P = A_t (q_T - q_{NL}) h_{TC} - D_a y \Delta w \quad (p.u.), \quad (3)$$

where  $A_t$  is a parameter that converts gate opening to per unit turbine power on the volt-ampere base of the generator and takes into account the turbine gain,  $q_{NL}$  is the no-load flow,  $D_a$  is turbine damping coefficient and  $\Delta w$  is turbine runner speed deviation.

From (2) it is clear that the turbine model is nonlinear and it is necessary to linearize the turbine model in order to obtain a linearized SISO model of the plant. Linearization of the turbine model is made by linearizing (2) and (3) in the following way:

$$\Delta q_T = k_{11} \Delta h_{TC} + k_{12} \Delta w_N + k_{13} \Delta y, \quad (4)$$

$$\Delta P = k_{21} \Delta h_{TC} + k_{22} \Delta w_N + k_{23} \Delta y, \quad (5)$$

where (6) and (7) define  $k_{1i}$  and  $k_{2i}$  coefficients ( $i = 1, 2, 3$ ):

$$k_{11} = \frac{\partial q_T}{\partial h_{TC}}, \quad k_{12} = \frac{\partial q_T}{\partial w_N}, \quad k_{13} = \frac{\partial q_T}{\partial y}, \quad (6)$$

$$k_{21} = \frac{\partial P}{\partial h_{TC}}, \quad k_{22} = \frac{\partial P}{\partial w_N}, \quad k_{23} = \frac{\partial P}{\partial y}. \quad (7)$$

Linearization is made for the operating point:

$$h_{TC} = 1 \quad (p.u.),$$

$$w_N = 1 \quad (p.u.), \quad (8)$$

$$y = Y_0 = 0.3 \quad (p.u.).$$

After combining (1), (4) and (5), the linearized unit's mechanical power is:

$$\Delta P = k_{22} \Delta w_N + k_{23} \Delta y - \frac{k_{21}(k_{12} \Delta w_N + k_{13} \Delta y)(-s T_w)}{-1 + k_{11}(-s T_w)}. \quad (9)$$



It is assumed that the unit is synchronized to the grid and turbine governor works in frequency/load controller mode. In case when the grid is “stiff”,  $\Delta w_N \approx 0$  because frequency deviation can be considered negligible.

Finally, the transfer function that describes turbine’s mechanical power output as a function of the guide vane angle is expressed by:

$$\frac{\Delta P}{\Delta y} = \frac{k_{23} - (k_{13}k_{21} - k_{11}k_{23})T_w s}{1 + k_{11}T_w s}. \quad (10)$$

Additionally, guide vane opening  $\Delta y$  is actuated by hydraulic servo, whose transfer function is:

$$\frac{\Delta y}{u} = \frac{1}{T_a s + 1}, \quad (11)$$

where  $T_a$  is a time constant that describes dynamic of hydraulic servo actuating system and  $u$  is control signal produced by governor. Finally, the transfer function that describes SISO linearized plant model is:

$$\frac{P}{u} = \left( \frac{1}{T_a s + 1} \right) \left( \frac{k_{23} - (k_{13}k_{21} - k_{11}k_{23})T_w s}{1 + k_{11}T_w s} \right). \quad (12)$$

Classical PI governor used for simulation purposes has the following transfer function:

$$u = \left( K_p + \frac{K_i}{s} \right) (r - P), \quad (13)$$

where  $r$  is an active power set-point.

If hydropower plant provides primary reserve, active power set-point varies with respect to the grid frequency. Active power set-point change is then:

$$R = r + D(f_N - f_G), \quad (14)$$

where  $D$  presents droop characteristic,  $f_N$  is nominal frequency and  $f_G$  is grid frequency.

### III. SISO GPC

#### A. Unconstrained SISO GPC

MPC as a control strategy has many variants and GPC is one of the most frequently used predictive control strategies, which is used in this paper.

The main idea of GPC is to include within the controller the simplest possible predictive model of the plant. The predictive model used in GPC is represented in form of transfer function. The model predicts future output of the plant based on the past and the present values of control and measured/estimated outputs of the plant if subjected to a given control input sequence. At each time step the plant’s output is predicted for a specified number of samples ( $N$ ) into the future, known as the prediction horizon, while control input can also be changed only for a specified number of samples ( $N_u$ ) into the future, known as the control horizon. This means that the predicted error of the plant’s output from a reference trajectory can be calculated. The calculations of control sequence are done in a

way that an optimization problem is set up and solved. Cost function, which is as part of the optimization problem, can be set up in various ways depending on response specifications of the plant and the type of optimization problem.

Only the first value of the computed control sequence is applied to the plant at the time step for which the calculations are made. At the next time step, the output of the plant is measured/estimated, and the entire computation procedure is repeated using the receding horizon principle.

The quadratic cost function, which is used in this paper, to be minimized at each sample  $k$  is expressed by:

$$J = \left[ e_{\underline{k+1}}^T \ e_{\underline{k+1}} \right] + \left[ \Delta u_{\underline{k}}^T \ \Delta u_{\underline{k}} \right] \mathbf{W}_u, \quad (15)$$

$$e_{k+1} = r_{k+1} - y_{k+1}, \quad (16)$$

where  $r_{\underline{k+1}}$  is the future reference trajectory vector,  $y_{\underline{k+1}}$  is the optimal predicted output of the plant defined at prediction horizon  $N$ ,  $\Delta$  is the  $(1 - z^{-1})$  operator,  $u_{\underline{k}}$  is a control sequence and  $W_u$  positive definite weighting matrix used to penalize control effort. Vectors  $r_{\underline{k+1}}$ ,  $y_{\underline{k+1}}$  and matrix  $W_u^{[N_u \times N_u]}$  are expressed by:

$$r_{\underline{k+1}} = \begin{bmatrix} r_{k+1} \\ r_{k+2} \\ \vdots \\ r_{k+N} \end{bmatrix}, y_{\underline{k+1}} = \begin{bmatrix} y_{k+1} \\ y_{k+2} \\ \vdots \\ y_{k+N} \end{bmatrix}, \mathbf{W}_u = \begin{bmatrix} W_u & \dots & 0 \\ \vdots & \ddots & \vdots \\ 0 & \dots & W_u \end{bmatrix}. \quad (17)$$

The discrete-time predictive model used within GPC controller in this paper is represented by using the Controlled Autoregressive Integrated Moving Average (CARIMA) model:

$$a(z)\Delta y_k = b(z)\Delta u_k + T(z)\epsilon(z). \quad (18)$$

For convenience, as the output is measured, the prediction model uses variables of the output and input increment and assumes the best estimate of future random term  $T(z)\epsilon(z) = 0$ .

In (18),  $b(z)$  is a polynomial that represents numerator of the transfer function, while  $a(z)$  is a polynomial that represents denominator of the transfer function:

$$a(z) = 1 + a_1 z^{-1} + \dots + a_n z^{-n}, \quad a(z)\Delta = A(z), \quad (19)$$

$$b(z) = b_1 z^{-1} + \dots + b_m z^{-m}. \quad (20)$$

There is no need for a disturbance estimate in this prediction model because disturbance estimate is implicit within the use of increments.

Instead of using recursion to find dependence of the output predictions upon past (or known) data and decision variables, output predictions can be found by using compact matrix/vector form:

$$y_{\underline{k+1}} = H \Delta u_{\underline{k}} + P \Delta u_{\underline{k-1}} + Q y_{\underline{k}}, \quad (21)$$

where  $H$ ,  $P$  and  $Q$  matrixes are expressed as:

$$H = C_A^{-1}C_b, P = C_A^{-1}H_b, Q = C_A^{-1}. \quad (22)$$

Matrixes  $C_A$ ,  $C_b$ ,  $H_A$  and  $H_b$  are expressed by:

$$C_A = \begin{bmatrix} 1 & \dots & 0 & 0 \\ A_1 & 1 & 0 & 0 \\ \vdots & \ddots & \vdots & 0 \\ A_{N-1} & A_{N-2} & \dots & 1 \end{bmatrix}, \quad (23)$$

$$H_A = \begin{bmatrix} A_1 & A_2 & \dots & A_{n-4} & A_{n-3} & \dots & A_{n-1} & A_n \\ A_2 & A_3 & \dots & A_{n-3} & A_{n-2} & \dots & A_n & 0 \\ \vdots & \dots & \dots & A_{n-2} & A_{n-1} & \dots & 0 & 0 \\ A_N & A_{N+1} & \dots & A_{n-1} & A_n & \dots & 0 & 0 \end{bmatrix}, \quad (24)$$

$$C_b = \begin{bmatrix} b_1 & 0 & 0 & 0 \\ b_2 & b_1 & 0 & 0 \\ \vdots & \ddots & \vdots & 0 \\ b_N & b_{N-1} & \dots & b_1 \end{bmatrix}, \quad (25)$$

$$H_b = \begin{bmatrix} b_2 & b_3 & \dots & b_{m-4} & b_{m-3} & \dots & b_{m-1} & b_m \\ b_3 & b_4 & \dots & b_{m-3} & b_{m-2} & \dots & b_m & 0 \\ \vdots & \dots & \dots & b_{m-2} & b_{m-1} & \dots & 0 & 0 \\ b_{N+1} & b_{N+2} & \dots & b_{m-1} & b_m & \dots & 0 & 0 \end{bmatrix}. \quad (26)$$

In the unconstrained case, the optimal control law can be found explicitly by substituting (21) into (15), which gives the following cost function to be minimized:

$$J = (\Delta u_k)^T (H^T H + \mathbf{W}_u I) \Delta u_k - 2(H \Delta u_k)^T (r_{k+1} - P \Delta u_{k-1} - Q y_k), \quad (27)$$

$$u^* = \min_{\Delta u_k} (J). \quad (28)$$

As the cost function is quadratic and strictly positive, a unique minimum is determined by:

$$\nabla(J) = 0, \quad (29)$$

which means that in the unconstrained case the optimal control sequence can be calculated using the following equation:

$$\Delta u_k = (H^T H + \mathbf{W}_u I)^{-1} H^T (r_{k+1} - P \Delta u_{k-1} - Q y_k). \quad (30)$$

From (30) it is clear that the optimal control sequence in unconstrained case depends linearly on the future reference trajectory and past inputs/outputs.

Only the first value of the computed control sequence in (30) is applied to the plant since optimization procedure is repeated at every next time step and proposed future control increments in the current time step will be adjusted and improved in the following time steps.

Since GPC algorithm used in this paper is set up in a way that optimal input increment is calculated at each time step, the control signal sent from the controller to the actuator at time step  $k$  is computed in the following way:

$$u_k = u_{k-1} + \Delta u_k. \quad (31)$$

### B. Constrained SISO GPC

Two main advantages of the MPC over the classical controllers, i.e. PID structure controllers, are following [12], [13]:

- MPC incorporates hard constraints into control law naturally during the controller design phase,
- it is relatively straightforward to extend MPC controller for SISO application to multiple input multiple output (MIMO) application.

Typical types of constraints which are usually defined within the GPC algorithm are [12], [13], [14]:

- upper and lower limits on an input  
 $\min u \leq u_k \leq \max u \quad \forall k$ ,
- upper and lower limits on input rates  
 $\min \Delta u \leq \Delta u_k \leq \max \Delta u \quad \forall k$ ,
- upper and lower limits on a state/output  
 $\min y \leq y_k \leq \max y \quad \forall k$ .

It is also possible to have mixed constraints, i.e. linking inputs at different samples. Constrains included in GPC algorithm are constraints on guide vane rate and amplitude. The quadratic cost function defined in (15) is used as well, in order to set up predictive controller as a quadratic programming problem subject to the control constraints  $C \Delta u_k \leq c$ .

Matrix  $C^{[4N_u \times N_u]}$ , vector  $c^{[4N_u \times 1]}$  and vector  $\Delta u_k^{[N_u \times 1]}$  are defined as follows:

$$C = \begin{bmatrix} I \\ -I \\ I \\ -I \end{bmatrix}, \quad \Delta u_k = \begin{bmatrix} \Delta u_k \\ \Delta u_{k+1} \\ \vdots \\ \Delta u_{k+N_u-1} \end{bmatrix}, \quad (32)$$

$$c = \begin{bmatrix} l(\max u) \\ -l(\min u) \\ l(\max \Delta u) \\ -l(\min \Delta u) \end{bmatrix}, \quad l = \begin{bmatrix} 1 \\ 1 \\ \vdots \\ 1 \end{bmatrix}.$$

Dimension of vector  $l$  is  $[N_u \times 1]$ .

### C. The Predictive Model of the Plant

GPC controller is designed using transfer function of Unit 3 of hydropower plant Miljacka defined in Section II, which consists only of guide vane and hydraulic subsystems. The predictive model of the plant with sample period  $T_s = 0.25$  s has the following transfer function:

$$G(z) = \frac{0.2908z + 1.74}{z^2 - 0.7851z + 0.1494}. \quad (33)$$

The polynomials in (19) and (20) are:

$$a(z^{-1}) = 1 - 0.7851z^{-1} + 0.1494z^{-2}, \quad (34)$$

$$b(z^{-1}) = 0.2908z^{-1} + 1.74z^{-2}. \quad (35)$$

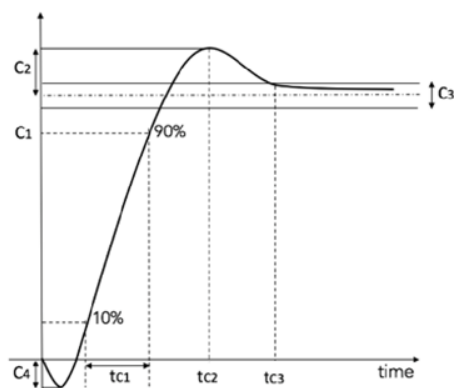

Figure 3. Response specifications for a step change.

#### IV. RESULTS AND DISCUSSION

Unconstrained GPC controller does not include the rate-limit constraint at the guide vane, which is mandatory in the turbine governor applications. A fixed rate-limit, at which the guide vane can open or close, prevents excessive variations in the tunnel pressure and is necessary due to safety reasons. Additionally, this constraint plays a vital role in mitigating the NMP behavior, which occurs during the initial part of power transients. Due to these reasons, this section contains only the response produced by a constrained GPC controller, which is compared to the response produced by the PI controller. Two cases are analyzed. In the first case load/frequency controller does not have an obligation to provide primary reserve (load control mode), while in the second case obligation to provide primary reserve is included (frequency control mode). The step response specifications for single-unit operations, shown in Fig. 3, is used as a reference.

The three most important criteria that will be analyzed are the following:

- NMP undershoot,
- Overshoot,
- Primary response – at least 90% of demanded step power change realized within 10 s of initiation.

Table II shows that NMP response ( $C_4$  criterion) must be under 2% and overshoot ( $C_2$  criterion) must be below 4%.

The responses of the model introduced in Section II are given in Fig. 4 and Fig. 5, respectively. Load control mode is presented in Fig. 4, while frequency control mode is presented in Fig. 5. Black dotted line in both figures presents the response of the PI controller, while blue line is used to

TABLE II  
SPECIFICATIONS FOR THE CONTROL DESIGN [15].

Criterion	Specification for single unit step response
$C_1$ - rise time	$C_1 \geq 90\%$ at $t_{C_1} = 10$ s
$C_2$ - overshoot	$C_2 \leq 4\%$ and $t_{C_2} \leq 15$ s
$C_3$ - settling time	$t_{C_3} = 30$ s for $C_3 \leq 0.5\%$
$C_4$ - NMP	$C_4 \leq 2\%$

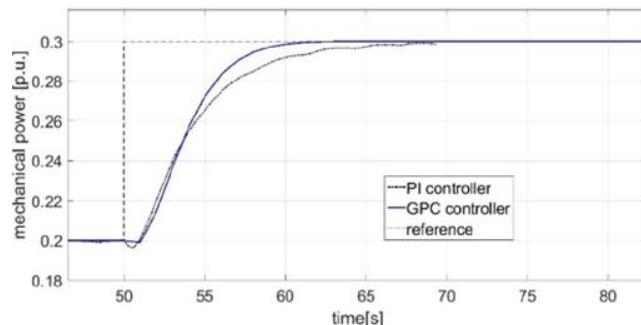

Figure 4. Comparison of step responses produced by the GPC and PI controllers – load control mode.

present the response of GPC controller. Simulated PI and GPC controller settings are given in Table III. The following GPC controller settings are defined in Table III: prediction horizon  $N$ , control horizon  $N_u$  and control weighting  $W_u$ . Aspects constituting a long prediction and control horizons are not explicitly defined and for every application may require the trial-and-error simulations. In this paper, the trial-and-error simulations result in minimum prediction horizon length  $N = 40$ , control horizon length  $N_u = 10$  and control weighting  $W_u = 150$ . The parameters of the PI controller are defined in the way that the system has reasonable value of the gain margin ( $2 \leq G_m \leq 5$ ) and the phase margin ( $30^\circ \leq P_m \leq 60^\circ$ ) [16]. The gain and phase margin for the analysed system are given in Fig 6.

TABLE III  
CONTROLLER SETTINGS.

Controller	Settings	
PI	$K_p = 0.017$	$K_i = 0.17$
GPC	$N = 40$	$N_u = 10$
	max $u = 1$ p.u.	min $u = 0$ p.u.
	max $\Delta u = 0.1$ p.u.	min $\Delta u = 0.01$ p.u.
	$W_u = 150$	

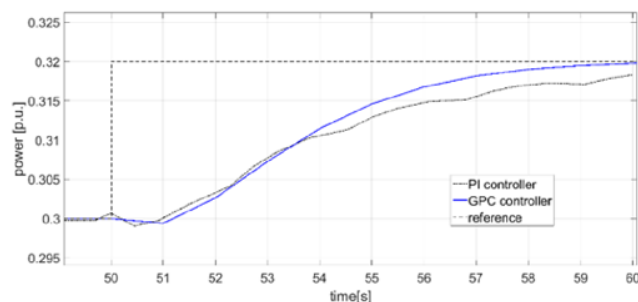

Figure 5. Comparison of step responses produced by the GPC and PI controllers – frequency control mode.

Structure of both models is presented in Fig. 2. Black line in Fig. 2. presents grid frequency measurement required in frequency control mode. Parameter  $D$  is used to introduce the droop characteristic. The value of  $D$  in the frequency control

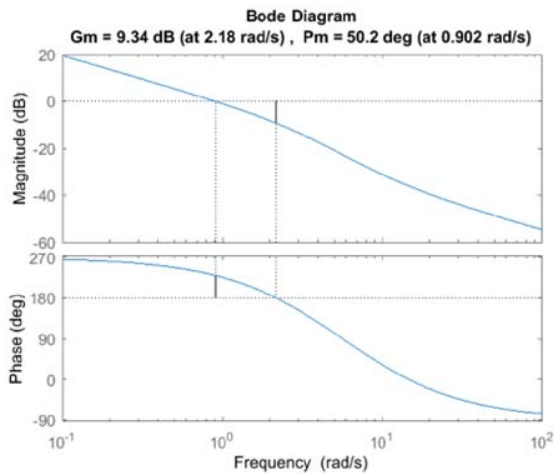

Figure 6. Stability margins.

mode is equal to 2%, which means that if grid frequency decreases by 1%, the hydropower plant will increase its power output by 2% to stop further frequency decrease.

Additionally, a comparison of PI and GPC responses using the criteria defined in Table II is shown in Tables IV and V.

TABLE IV

COMPARISON OF PI AND GPC RESPONSES – LOAD CONTROL MODE.

Criterion	PI	GPC
$C_1$	90% at 9.2 s	90% at 6.9 s
$C_2$	No overshoot	No overshoot
$C_3$	11.9 s	8.1 s
$C_4$	3.8%	1%

TABLE V

COMPARISON OF PI AND GPC RESPONSES – FREQUENCY CONTROL MODE.

Criterion	PI	GPC
$C_1$	90% at 9.8 s	90% at 7.1 s
$C_2$	No overshoot	No overshoot
$C_3$	11.2 s	7.5 s
$C_4$	3.4%	1.3%

In the first case, where load control mode is simulated, Unit 3 of hydropower plant Miljacka operates initially at 0.2 p.u. of the full load. After that, a 0.1 p.u. step demand (10% of the rated power) is applied to Unit 3. Fig. 4 and Table IV show that step response in load control mode with GPC controller settles 3.8 s sooner, NMP undershoot is reduced by 2.8% and primary response is 2.3 s faster than in the case with the PI controller.

In the second case, where automatic frequency control mode is simulated, Unit 3 of hydropower plant Miljacka operates initially at 0.3 p.u. of the full load. At  $t = 50$  s, a disturbance occurs and the grid frequency is decreased by 1%. Since the droop characteristic of Unit 3 is  $D = 2\%$ , active

power reference trajectory is increased by 2% (0.02 p.u) to compensate for this frequency deviation. Fig. 5 and Table V show that response in the frequency control mode with GPC controller settles 3.7 s sooner, NMP undershoot is reduced by 2.1% and primary response is 2.7 s faster than in the case with the PI controller.

Additional simulations, presented in Fig. 7, are conducted with  $W_u$  values of 150, 100, 50 and 10. They show that it is possible to achieve faster GPC response by reducing the value of  $W_u$ , which penalizes the control effort. In this case, NMP undershoot and overshoot are increased, which means that further improvements are possible only at the expense of another criteria.

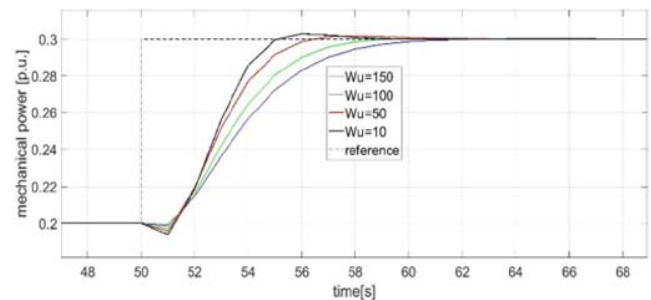

Figure 7. Influence of  $W_u$  on GPC response.

## V. CONCLUSION

The main intention of this paper was to show the possibility of applying MPC controller as frequency/load controller in a turbine governor. A linearized SISO plant model was used for the simulation purposes and comparison between the standard PI and the MPC controller shows that predictive control strategy improves control behavior of a turbine governor. In Section IV, simulation results have shown that PI controller violates undershoot criterion, defined in Table II, while GPC controller satisfies all criteria and shows superiority over the classical PI controller.

Although the GPC controller simulations have shown promising results, it is still not clear whether this type of controllers have practical implementation potential due to implementation complexity and difficulty of industrial application of the predictive control. A new generation of turbine governor hardware is capable of dealing with computational requirements of prediction control, but to the best of the authors' knowledge, currently there is no practical implementation of the predictive control in the turbine governor applications. Therefore, further research will primarily be focused on the practical implementation of the predictive controller on a hydropower plant model available in the Smart Grid Laboratory at the University of Zagreb Faculty of Electrical Engineering and Computing. Furthermore, behavior of the MPC controller in presence of measurement noise and the influence of predictive control strategy on control activity of the plant will be investigated.

## ACKNOWLEDGEMENT

This work has been supported in part by the Croatian Environmental Protection and Energy Efficiency Fund under project Microgrid Positioning – uGRIP, as well as by Croatian Science Foundation and Croatian TSO (HOPS) under project Smart Integration of RENEwables - SIREN (I2583-2015).

## REFERENCES

- [1] J. Culberg, M. Negnevitsky, and K.A. Kashem, "Hydro-turbine governor control: theory, techniques and limitations", in *Australasian Universities Power Engineering Conference, (AUPEC 2006)*, 2006.
- [2] ABB, "Hydro power - Intelligent solutions for hydro governors", 2016.
- [3] C. Aurora, L. Magni, R. Scattolini, P. Colombo, F. Pretolani and G. Villa, "Predictive Control of thermal Power Plants", *International Journal of Robust and Nonlinear Control*, vol. 14, no. 4, pp.415-433, 2004.
- [4] A. Y. Begum, and G. V. Marutheeswar, "Design of MPC for superheated steam temperature control in a coal-fired thermal power plant", *Indonesian Journal of Electrical Engineering and Computer Science*, vol. 4, no. 1, pp.73-82, 2016.
- [5] O. Mohamed, J. Wang, A. Khalil, and M. Limhabrash, "Predictive control strategy of a gas turbine for improvement of combined cycle power plant dynamic performance and efficiency", *SpringerPlus*, vol. 5, no. 1, p.980, 2016.
- [6] L. C. Henriksen, M. H. Hansen, and N. K. Poulsen, "Wind turbine control with constraint handling: a model predictive control approach", *Published in IET Control Theory and Applications*, vol. 6, no. 11, pp.1722-1734, 2012.
- [7] L. C. Henriksen, N. K. Poulsen, and M. H. Hansen, "Nonlinear Model Predictive Control of a Simplified Wind Turbine", *Proceedings of the 18th World Congress The International Federation of Automatic Control*, vol. 44, no. 1, IFAC, 2011.
- [8] B. Strah, "The water turbine regulation of adaption to faults in guide vane system", Master Thesis (in Croatian), University of Zagreb Faculty of Electrical engineering and Computing, 2000.
- [9] P. Kundur, *Power System Stability and Control*, New York:McGraw-Hill, 1994.
- [10] T. Tomisa, "Parameter Estimation of High Pressure Hydro-Electric Power Plant Conduit Hydraulic System", Doctoral Thesis (in Croatian), University of Zagreb Faculty of Electrical Engineering and Computing, 1995.
- [11] Working Group on Prime Mover and Energy Supply Models for System Dynamic Performance Studies, "Hydraulic Turbine and Turbine Control Models for System Dynamic Studies", *IEEE Transactions on Power Systems*, vol. 7, no. 1, pp.167-179, 1992.
- [12] J. M. Maciejowski, *Predictive control: with constraints*, Englewood Cliffs, NJ: Prentice-Hall, 2002.
- [13] E. F. Camacho and C. Bordons, *Model Predictive Control*, New York: Springer-Verlang, 1999.
- [14] L. Wang, *Model Predictive Control System Design and Implementation Using MATLAB.*, Springer, 2009.
- [15] K. J. Astrom and T. Hagglund, *PID controllers: theory, design and tuning.*, Instrument Society of America, Research Triangle Park, NC, 1995.
- [16] K. J. Astrom and R. M. Murray, *Feedback Systems: An Introduction for Scientists and Engineers.*, vol. 36, no. 4. 2008.

# List of Figures

Figure 2.1. Overview of PID tuning techniques (based on analysis in [21], [22]). . . . .	6
Figure 2.2. Ziegler–Nichols method for tuning P, PI, and PID controllers (adapted from [23]). . . . .	7
Figure 2.3. Structure of self tuning fuzzy PID controller (adapted from [35]). . . . .	8
Figure 2.4. Structure of the GA-PID controller [44]. . . . .	9
Figure 3.1. Overview of hydro power plant models (adapted from [27]). . . . .	16
Figure 3.2. Schematic diagram of the laboratory hydro power plant in SGLab (adapted from [93]). . . . .	17
Figure 3.3. Sketch of a small scale Pelton turbine [79]. . . . .	18
Figure 3.4. Basic functioning of a Pelton turbine [85]. . . . .	19
Figure 3.5. MPC strategy. . . . .	20
Figure 3.6. Specifications of the plant response [Pub4]. . . . .	22

# List of Tables

Table 2.1. Overview of industrial standards for hydro turbine governors. . . . .	12
Table 3.1. Classification of small-scale hydro power plants with respect to installed capacity. . . . .	15

# Biography

Mateo Beus is currently employed as a senior researcher and teaching assistant at the Department of Energy and Power Systems at Faculty of Electrical Engineering and Computing, University of Zagreb. From this Faculty, he received his bachelor's and master's degree in 2012 and 2014, respectively. His employment experience also includes working as an engineer at Brodarski Institute Ltd. (2014.-2015.) and Eccos Engineering Ltd. (2015.-2016.)

His research interests include distribution grid automation, integration and management of distributed energy resources, control of hydro power plants and control and protection of microgrids.

He participated in numerous science projects funded by European Commission and Croatian Science Foundation. The majority of the projects is related to microgrids (control, protection and market integration aspects). Furthermore, he also took part into writing of the proposals for some of the projects.

He is also involved in teaching activities as a teaching assistant in Master Programme courses (Electricity Markets, Energy Storage, Distribution Networks and Distributed Generation, Electric Facilities Automation etc.).

He has published a range of journal (5) and conference (10) papers.



## Journal Papers

- [J1] M. Beus, I. Pavić, I. Štritof, T. Capuder, and H. Pandžić, “Electricity Market Design in Croatia within the European Electricity Market—Recommendations for Further Development,” *Energies*, vol. 11, 2018, ISSN: 1996-1073. DOI: 10.3390/en11020346.
- [J2] M. Beus and H. Pandžić, “Application of an adaptive model predictive control algorithm on the pelton turbine governor control,” *IET Renewable Power Generation*, vol. 14, pp. 1720–1727, Apr. 2020, ISSN: 1752-1416. DOI: 10.1049/iet-rpg.2019.1291.
- [J3] M. Beus, F. Banis, H. Pandžić, and N. Poulsen, “Three-level hierarchical microgrid control - model development and laboratory implementation,” *Electric Power System Research*, vol. 189, pp. 1720–1727, Dec. 2020, ISSN: 0378-7796. DOI: 10.1016/j.epsr.2020.106758.
- [J4] M. Beus and H. Pandžić, “Practical Implementation of a Hydro Power Unit Active Power Regulation Based on an MPC Algorithm,” *IEEE Transactions on Energy Conversion*, pp. 1–1, Jul. 2021, ISSN: 1558-0059. DOI: 10.1109/TEC.2021.3094059.
- [J5] M. Beus, M. Krpan, I. Kuzle, H. Pandžić, and A. Parisio, “A Model Predictive Control Approach to Operation Optimization of an Ultracapacitor Bank for Frequency Control,” *IEEE Transactions on Energy Conversion*, vol. 36, pp. 1743–1755, 2021. DOI: 10.1109/TEC.2021.3068036.

**Conference Papers**

- [C1] I. Pavić, M. Beus, H. Pandžić, T. Capuder, and I. Štritof, “Electricity markets overview — Market participation possibilities for renewable and distributed energy resources,” in *2017 14th International Conference on the European Energy Market (EEM)*, IEEE, 2017, pp. 1–5. DOI: 110.1109/EEM.2017.7981917.
- [C2] I. Pavić, M. Beus, H. Pandžić, T. Capuder, and I. Štritof, “Tržište električne energije u Republici Hrvatskoj – položaj distribuiranih izvora fleksibilnosti,” in *13. savjetovanje HRO CIGRÉ*, 2017, pp. 1–10.
- [C3] M. Beus, I. Pavić, H. Pandžić, T. Capuder, I. Štritof, and I. Andročec, “Evaluating Flexibility of Business Models for Distributed Energy Resource Aggregators,” in *2018 15th International Conference on the European Energy Market (EEM)*, IEEE, 2018, pp. 1–5. DOI: 10.1109/EEM.2018.8469776.
- [C4] I. Pavić, M. Beus, V. Bobanac, and H. Pandžić, “Decentralized Master-Slave Communication and Control Architecture of a Battery Swapping Station,” in *2018 IEEE International Conference on Environment and Electrical Engineering and 2018 IEEE Industrial and Commercial Power Systems Europe (EEEIC / I CPS Europe)*, IEEE, 2018, pp. 1–6. DOI: 10.1109/EEEIC.2018.8494601.
- [C5] M. Beus and H. Pandžić, “Application of Model Predictive Control Algorithm on a Hydro Turbine Governor Control,” in *2018 Power Systems Computation Conference (PSCC)*, IEEE, 2018, pp. 1–7. DOI: 10.23919/PSCC.2018.8442594.
- [C6] M. Beus, I. Pavić, H. Pandžić, T. Capuder, I. Štritof, and I. Andročec, “Modeli za sudjelovanje agregatora distribuiranih pružatelja usluga fleksibilnosti na tržištu električne energije u Republici Hrvatskoj,” in *Sixth Session of CIRED Croatian National Committee*, 2018, pp. 1–10.
- [C7] I. Pavić, M. Beus, H. Pandžić, T. Capuder, I. Štritof, and I. Andročec, “Impact of an Aggregator of Distributed Energy Resources on Traditional Power System Participants,” in *Cired Workshop 2018 on Microgrids and Local Energy Communities*, 2018, pp. 1–4.
- [C8] M. Beus, M. Krpan, H. Pandžić, and I. Kuzle, “Korištenje modelskog prediktivnog upravljanja za optimizaciju pogona superkondenzatora u svrhu pružanja primarne regulacije frekvencije,” in *14. Simpozij o vođenju EES-a HRO CIGRÉ*, 2020, pp. 1–10.
- [C9] M. Beus, I. Grcić, and H. Pandžić, “Microgrid Dispatch with Protection Constraints,” in *2021 International Conference on Smart Energy Systems and Technologies (SEST)*, 2021, pp. 1–6. DOI: 10.1109/SEST50973.2021.9543224.

- [C10] I. Kuzle, M. Krpan, and M. Beus, “Razvoj laboratorija za napredne elektroenergetske mreže,” in *15. savjetovanje HRO CIGRÉ*, 2021, pp. 1–10.

# Životopis

Mateo Beus je trenutno zaposlen kao iskusni istraživač i asistent na Zavodu za visoki napon i energetiku Fakulteta elektrotehnike i računarstva Sveučilišta u Zagrebu. Prvostupnik na istom fakultetu je postao 2012, a diplomirao je 2014. Njegovo radno iskustvo također uključuje i rad kao inženjer u Brodarskom institutu (2014.-2015.) te tvrtki ECCOS inženjering d.o.o. (2015.-2016.).

Njegovo područje interesa uključuje automatizaciju distribucijskih mreža, integraciju i upravljanje distribuiranim izvorima energije, upravljanje hidroelektranama te upravljanje i zaštitu u mikromrežama.

Sudjelovao je u brojnim znanstvenim projektima financiranim od strane Europske komisije te Hrvatske zaklade za znanost. Većina projekata na kojima je radio povezana je s mikromrežama (upravljanje, zaštita te aspekti tržišne integracije). Nadalje, sudjelovao je i u pisanju prijave za neke od projekata.

Uključen je također i u nastavne aktivnosti na diplomskom studiju kao asistent (Tržište električne energije, Spremnici energije, Razdjelne mreže i distribuirana proizvodnja, Automatizacija električnih postrojenja, itd.).

Objavio je veći broj radova u časopisima (5) i konferencijama (10).