

# Brain-computer interface based on anticipatory potentials

---

**Božinovski, Adrijan**

**Doctoral thesis / Disertacija**

**2024**

*Degree Grantor / Ustanova koja je dodijelila akademski / stručni stupanj:* **University of Zagreb, Faculty of Electrical Engineering and Computing / Sveučilište u Zagrebu, Fakultet elektrotehnike i računarstva**

*Permanent link / Trajna poveznica:* <https://urn.nsk.hr/urn:nbn:hr:168:356639>

*Rights / Prava:* [In copyright](#)/[Zaštićeno autorskim pravom.](#)

*Download date / Datum preuzimanja:* **2024-07-15**



*Repository / Repozitorij:*

[FER Repository - University of Zagreb Faculty of Electrical Engineering and Computing repository](#)



UNIVERSITY OF ZAGREB  
FACULTY OF ELECTRICAL ENGINEERING AND COMPUTING  
SVEUČILIŠTE U ZAGREBU  
FAKULTET ELEKTROTEHNIKE I RAČUNARSTVA

**Adrijan Božinovski**

**BRAIN-COMPUTER INTERFACE BASED  
ON ANTICIPATORY POTENTIALS**

**SUČELJE MOZGA S RAČUNALOM  
ZASNOVANO NA ANTICIPACIJSKIM  
POTENCIJALIMA MOZGA**

DOCTORAL THESIS  
DOKTORSKA DISERTACIJA

Zagreb, 2009

The Doctoral Dissertation has been prepared at the

**School of Computer Science and Information Technology**

**University American College Skopje,**

**and**

**Department of Electronic systems and Information Processing**

**University of Zagreb**

Mentors:

**Prof. Stanko Tonković, Ph.D.**

**Ass. Prof. Velimir Išgum, Ph.D.**

The Doctoral Dissertation has \_\_\_\_\_ pages

Doctoral Dissertation Nr. \_\_\_\_\_

The dissertation evaluation committee:

1. Professor Ratko Magjarević, Ph. D.  
Faculty of Electrical Engineering and Computing, University of Zagreb
2. Professor Stanko Tonković, Ph. D.  
Faculty of Electrical Engineering and Computing, University of Zagreb
3. Assistant Professor Velimir Išgum, Ph. D.  
University Hospital Centre Zagreb
4. Professor Damir Kalpić, Ph. D.  
Faculty of Electrical Engineering and Computing, University of Zagreb
5. Professor Nikola Bogunović, Ph. D.  
Faculty of Electrical Engineering and Computing, University of Zagreb

The dissertation defense committee:

1. Professor Ratko Magjarević, Ph. D.  
Faculty of Electrical Engineering and Computing, University of Zagreb
2. Professor Stanko Tonković, Ph. D.  
Faculty of Electrical Engineering and Computing, University of Zagreb
3. Assistant Professor Velimir Išgum, Ph. D.  
University Hospital Centre Zagreb
4. Professor Damir Kalpić, Ph. D.  
Faculty of Electrical Engineering and Computing, University of Zagreb
5. Professor Nikola Bogunović, Ph. D.  
Faculty of Electrical Engineering and Computing, University of Zagreb

Date of dissertation defense: 20<sup>th</sup> May 2010

# ACKNOWLEDGEMENTS

Professor Stanko Tonković has been my mentor and my guide throughout both my master's and doctoral study. His insights and support have been crucial for the correct focus of this thesis. His openness and directness have been the catalysts to open and heartfelt communication, out of which solutions to many problems were found. His thorough and sincere support and honesty, as well as technical knowledge, are some of the things that I'll always be grateful for to my mentor.

Assistant professor Velimir Išgum was my co-mentor both throughout my master's and doctoral study as well. His comprehensive expertise of the field of brain potentials and especially anticipatory brain potentials was the cause for many thought-provoking questions and problems, which have pushed this thesis to its limits. Some of the key issues addressed in this thesis are the direct result of dr. Išgum's insights, and I am very grateful and honored to have had the opportunity to have such an expert as one of my mentors.

The Mesarić family was the source of family atmosphere, and family itself, throughout my seven years of stay in Zagreb. Thanks to them, in a large part, my studies in Zagreb were turned into a memorable experience, which I'll always be glad for. They offered a helping hand during the testing moments of my residence, for which I am especially grateful.

Finally, great and extended thanks go to my family, which always supports me during the course of my studies and life. They always help me become a better academic citizen, scientist and person, and everything that I have done and will do is thanks to and helped by them. An immense support and inspiration, they are the cornerstone of my professional and personal development and I hope to be able to make them proud of me in years to come.

Adrijan Božinovski

# FOREWORD

Brain computer interface (BCI) is a relatively new research area. It explores possibilities of controlling devices using brain potentials only. The contribution is in the introduction of anticipatory brain potentials in the BCI research, as well as algorithms and software for BCI control of two robots to solve a common task.

Following the author's employment as a bioinformatics engineer and lab assistant at the Laboratory of Neurophysiology, at the Institute of Physiology at the Medical Faculty at the University "Sv. Kiril i Metodij" in Skopje, Macedonia, in fall 2005, he obtained duties, such as conducting lab exercises for courses of physiology, specifically electrophysiology. The laboratory had been researching anticipatory brain potentials for at least a decade and that is how the author first got in contact and gained interest in the subject. Around this time the joint Macedonian-Croatian project got initiated, which led to obtaining new equipment, and the author was given the duty to create software that would make it function and operate according to the paradigms employed in the laboratory. This work led to greater understanding of anticipatory brain potentials, and especially the CNV paradigm. The author had already enrolled in the Master's program at the University of Zagreb, Faculty of Electrical Engineering and Computing, and the new environment and equipment only fostered his research. It was during this time that the idea appeared, that the CNV experimental paradigm could be used as a brain-computer interface paradigm. Thus far, the paradigm had been used for clinical and diagnostic purposes only, and, at the Laboratory, it still is. The developed software and the knowledge the author gained during the experimental work resulted in his M.Sc. project in 2007.

Continuation toward the Ph.D. thesis allowed deeper understanding of BCI possibilities based on anticipatory brain potentials. The author started experiments with robots and the robotic solution of the Towers of Hanoi task he had already worked on before. The author assembled two robots and developed necessary algorithms and software to solve the Towers of Hanoi task using BCI control of two robotic arms. This is the effort described in this Doctoral thesis.

This work is the result of the author's 5 years of effort in understanding and building brain-computer interfaces based on anticipatory brain potentials, and using them to control devices such as robots. **Chapter 1** introduces the subject, from the perspective of the broader area of human-computer interaction, and with an emphasis on electrophysiologically interactive human-computer interfaces. **Chapter 2** focuses on the brain-computer interface, as the theme of this work. **Chapter 3** explains the brain potentials, as the source of information for most brain-computer interfaces. **Chapter 4** focuses on the anticipatory brain potentials, as being of primary importance for this work. **Chapter 5** explains the CNV flip-flop paradigm, which is the experimental paradigm that is used in this work. **Chapter 6** gives an in-depth view into the algorithms used in the paradigm. **Chapter 7** proposes a generic design model for software solutions for BCI systems. **Chapter 8** presents the materials and methods used for the execution of the experiments. **Chapter 9** synthesizes the previous chapters and presents the practical part of this thesis, explaining the logic,

setup and results of the experiments carried out. **Chapter 10** gives a discussion and conclusion, presenting the results from the work. Following are references, a list of all the used abbreviations, summary of the dissertation, as well as the curriculum vitae.

# CONTENTS

1.	INTRODUCTION		1
	1.1.	Human-Computer Interaction	2
	1.2.	Electrophysiologically Interactive Human-Computer Interfaces	3
		1.2.1. Monitoring (Diagnosis) Oriented Scenarios	4
		1.2.2. Biofeedback Oriented Scenarios	4
		1.2.3. Control Oriented Scenarios	5
		1.2.4. Hands-Free Control Scenarios	5
2.	BRAIN-COMPUTER INTERFACE		7
	2.1.	History of BCI	8
	2.2.	Components of a BCI	9
	2.3.	BCI Signal Acquisition Techniques	11
	2.4.	BCI Training and Calibration Sessions	14
	2.5.	Brain States Used in a BCI	14
	2.6.	Signal Processing in BCI	16
	2.7.	Measure of a BCI Success	17
	2.8.	Examples of Applications	17
	2.9.	Challenges and Future Directions	18
3.	BRAIN POTENTIALS		19
	3.1.	Electroencephalogram (EEG) and Spontaneous Brain Activity	20
	3.2.	Frequency Analysis of EEG	22
	3.3.	Characteristics of EEG Waves	25
	3.4.	Effects of Various Degrees of Brain Activity to the Basic EEG Frequency	26
	3.5.	A Taxonomy of EEG Potentials	28
	3.6.	Evoked Brain Potentials	30
	3.7.	Exogenous Evoked Potentials	33
		3.7.1. Auditory Evoked Potentials	33
		3.7.2. Somatosensory Evoked Potentials	34
		3.7.3. Visual Evoked Potentials	34
	3.8.	Endogenous Evoked Potentials	35
		3.8.1. P300	35
		3.8.2. N400	36
	3.9.	Event Related Potentials and Cognitive Science	37
	3.10.	Event Related Potentials and Brain Functioning	37
4.	ANTICIPATORY BRAIN POTENTIALS		39
	4.1.	Preparatory Potentials. The Bereitschaftspotential	41
	4.2.	Expectatory Potentials. The Contingent Negative Variation	42
	4.3.	CNV Morphology	43
	4.4.	The CNV Paradigm	46
	4.5.	The CNV Potential and Cognitive Processes	47
5.	THE CNV FLIP-FLOP PARADIGM		48
	5.1.	Central Issues in the CNV Flip-Flop Paradigm	51
	5.2.	Electroexpectogram	54



6.	BCI ALGORITHMS APPLIED IN THE CNV FLIP-FLOP PARADIGM		55
	6.1.	Algorithms for Signal Pre-Processing	56
	6.2.	Algorithm for ERP Extraction	58
	6.3.	Algorithm for ERP Extraction as a Neural Learning Algorithm	59
	6.4.	Algorithms for Computing ERP Parameters	59
	6.5.	Algorithms for Recognizing the ERP as a CNV	60
	6.6.	A Neural Element for CNV Computation	61
	6.7.	A Neural Network for CNV Computation	62
7.	DESIGN MODEL FOR BCI SOFTWARE		64
	7.1.	BCI Design Model: Proposal	65
	7.2.	BCI Design Model: Implementation	66
	7.3.	BCI Design Model: Modules	68
		7.3.1. The Biosignal Acquisition Module	68
		7.3.2. The Device Control Module(s)	69
		7.3.3. The Experimental Paradigm Control Module	69
		7.3.4. The Graphical User Interface (GUI) Module	69
		7.3.5. The File Control Module	71
8.	MATERIALS AND METHODS		73
	8.1.	BCI Devices: Biosignal Acquisition Devices	74
	8.2.	BCI Devices: Robotic Arms	76
	8.3.	BCI Devices: Computer	78
	8.4.	Subjects in the Experiments	78
	8.5.	Experimental Procedure	81
9.	BCI BASED ON ANTICIPATORY POTENTIALS		83
	9.1.	The CNV Flip-Flop Paradigm as a BCI Paradigm	84
	9.2.	The Challenge of Controlling a Robot	85
	9.3.	The Towers of Hanoi Problem	86
	9.4.	BCI Based on Anticipation: Algorithm for Controlling a Multi-Behavior Device	86
	9.5.	The Experimental Setup	88
	9.6.	Control of Two Robotic Arms Using an Anticipation-Based BCI: Setup	90
	9.7.	Control of Two Robotic Arms Using an Anticipation-Based BCI: Example	93
	9.8.	Control of Two Robotic Arms Using an Anticipation-Based BCI: Statistics	99
10.	DISCUSSION		100
11.	CONCLUSION		106
	REFERENCES		109
	INTERNET REFERENCES		116
	APPENDIX A: SOFTWARE SPECIFICS OF THE BCI BASED ON ANTICIPATORY BRAIN POTENTIALS		117
	LIST OF USED ABBREVIATIONS		133
	DISSERTATION SUMMARY		134
	SAŽETAK DISERTACIJE		135
	CURRICULUM VITAE		136
	ŽIVOTOPIS		137

## **Chapter 1**

### **INTRODUCTION**

This chapter gives the framework within which this doctoral thesis is placed. It is the Computer Science research area named Human-Computer Interaction (HCI). Here the electrophysiologically interactive human-computer interfaces will be described, out of which the focus will be placed on brain-computer interfaces in the next chapters.

# 1. INTRODUCTION

The development of technology has led to numerous discoveries and breakthroughs in every aspect of the human life. Perhaps no other device has made such an impact as the computer, since it is present in virtually every human endeavor. From its inception as a calculating device, it was constantly refined and has grown to a complex system, with which special means of communication needed to be devised. The research area that deals with the ways in which humans and computers communicate is called *Human-Computer Interaction*.

## 1.1. Human-Computer Interaction

Any object, product, system, or service that will be used by humans has the potential for usability problems and should be subject to some form of usability engineering [Nielsen, 1993]. Cell phones, consumer electronics, and web interfaces, are all examples of wide use of design for interactive use [Schneiderman and Plaisant, 2004]. One such focus of usability engineering research is *Human-computer interaction*. It offers a wide variety of interaction modes, including multimedia modes, between humans and computers [Jacko and Sears, 2003].

Human-computer interaction is a two-way process. From the point of view of each side, two aspects must be observed: that the messages sent to the other side will be received and understood, and that the messages received from the other side will also be received and understood. Thus, the concept of an *interface* arises: a system that will interpret the messages from the form understandable to one side to a form understandable to the other side and vice versa. This way, one might consider the keyboard, the mouse, the computer screen etc, as interfaces through which the computer processor communicates messages from and to the user. These devices are all sorts of *Human-Computer Interface* (HCI) devices.

Historically, several generations of human-computer interaction have been noticed. Starting with the batch interface and punched cards (IBM 1130, IBM/360, IBM/3), an important step was the interactive terminal and command line (e.g. PDP 11). Almost revolutionary was the PC approach (Apple, Spectrum, Commodore, IBM PC), when humans accepted personal computers and their ports like parallel, serial, etc. The next step was a full-screen graphical user interface and a screen pointing device (“mouse”). Windows-oriented operating systems (Macintosh) expanded the usability range to users like musicians and many others. Color screens appeared and elements like buttons and drop down menus became standard in human-computer interaction. The World Wide Web expanded the use of computers even to politicians. Also, web sites like Facebook, MySpace and so on offer everyone a chance to communicate his/her thoughts and agendas to the entire Internet audience. Today, sound cards and cameras are standard devices with laptops and cell phones.

While offering various ways of communication, gradually computers started to develop an understanding of their users’ personality. User modelling, i.e. understanding the way the user thinks and what are the user’s interests and preferences, became an important issue. Various methods have been implemented in order to collect data for user modelling, including interviews and questionnaires. Analyzing the data and having models of their users, companies like Amazon offer books and other items according to user preferences.

Emotional aspects of the user have been studied, in order to produce positive emotions in users [Brave and Nass, 2003]. Anthropomorphic agents, virtual pets, and other software emotion-related tools were used to improve the human-computer interaction [Sharp et al, 2007].

That is the stage where the human-computer interaction stands at the moment. There is always the question about what is the next stage. Among many possibilities [Allanson, 2002], interfaces based on *electrophysiologically interactive human-computer interfaces* can be foreseen. Those types of devices will be the focus of the next section.

## **1.2. Electrophysiologically Interactive Human-Computer Interfaces**

*Electrophysiologically interactive human-computer interfaces* (EI-HCI) are such interfaces, in which the human output is achieved without the need of the human’s grasping and touching abilities (e.g. hands and fingers). Immediately, a challenge arises when designing such systems – if the human’s hands are to be bypassed, some other human-origin measurable data must be used. Candidates are: skin conductance change, brain impulses, heart rate change, etc. The data can be obtained, processed, and then used to control a device, or perform a task. However, to obtain the data, the EI-HCI can follow several scenarios, among which the most common ones are mentioned.

### 1.2.1. Monitoring (Diagnosis) Oriented Scenarios

Gathering and monitoring electrophysiological data is the key process in EI-HCI. The question is always which data to gather in order to deduce the medical or emotional status of the subject. For example, for gathering the *emotional status* of arousal in an HCI, good indicators are heart rate and skin conductance. They might be integral data sources for an emotional state. Also, the state of stress, high anxiety, absorption, fatigue, and inattention can also be important factors. Brain signals can provide direct access to aspects of human brain states such as cognitive workload, alertness, task involvement, emotion, and concentration. Figure 1.1. shows an EI-HCI with a monitoring oriented scenario.

As shown in Figure 1.1., User1 is the observed person, who generates physiological data collected by a physiological signals detection equipment, which is an augmentation of a PC that analyses and interprets the data. User2 is a physician or another person that observes the process, and he/she might not be always connected to the process.

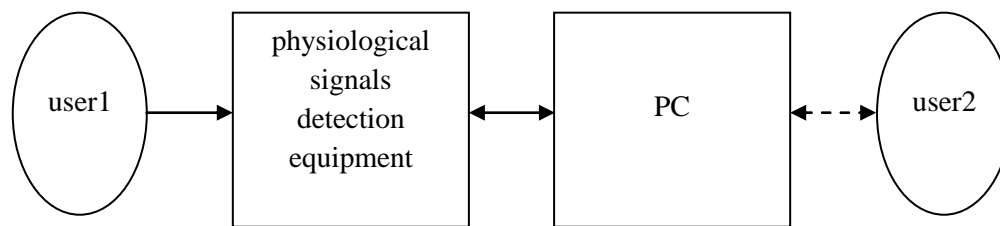

*Figure 1.1. Monitoring scenario for medical diagnosis, emotional status and operator reliability estimation*

### 1.2.2. Biofeedback Oriented Scenarios

Monitoring EI-HCIs are usually open-loop. Control systems are usually closed-loop. One very often closed-loop system in EI-HCI is the biofeedback setup, shown in Figure 1.2. User electrophysiological data are collected but the user has control over the collection itself and uses the data.

In a biofeedback setup, physiological changes are detected and relayed back to the subject audibly or visually, usually in real time. A physiological parameter such as heart rate or skin conductance is measured and the measured level is shown visually to the user. The user tends to voluntarily change the observed level, like lowering the heart rate by some relaxation technique and/or self-suggestion, for example. This scenario is used for self diagnosis, affective computing, operator safety (e.g. checking if the operator is awake), rehabilitation/therapy, critical episode notification, computer games, and also operator performance enhancement.

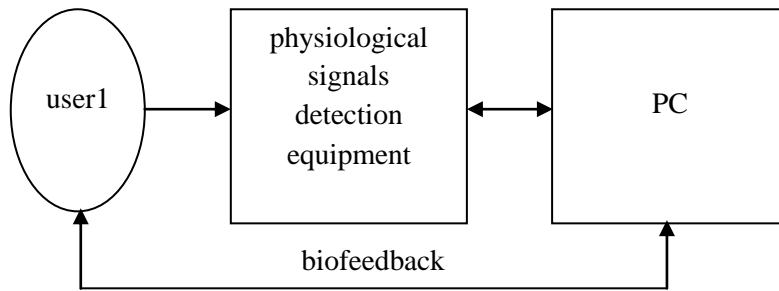

Figure 1.2. Biofeedback oriented scenario

Today, EEG (electroencephalogram) feedback and neurofeedback are used for treatment of psychophysiological disorders such as attention deficit, hyperactivity disorder, post-traumatic stress disorder, addictions, anxiety and depression. Surface-mounted electrodes detect brain signals and present it to the subject as abstract images in real time. Using this data in reward/response based control tasks generates increased or reduced activity in different aspects of the EEG spectrum to help the treatment of these psychophysiological disorders. The EEG itself and the brain potentials will be explained in more detail in the next section.

### 1.2.3. Control Oriented Scenarios

Device control is another area of EI-HCI research. Figure 1.3. shows a scenario of controlling devices, locally and remotely. The devices controlled could be prosthetic arms, home appliances, robots, etc.

Existing device control and biofeedback applications range from interactive 2D graphical tasks in which muscle signals are amplified and transformed, to control tasks such as lifting a virtual dumbbell, to real-world physical tasks such as manipulating robots and devices including radio-controlled devices.

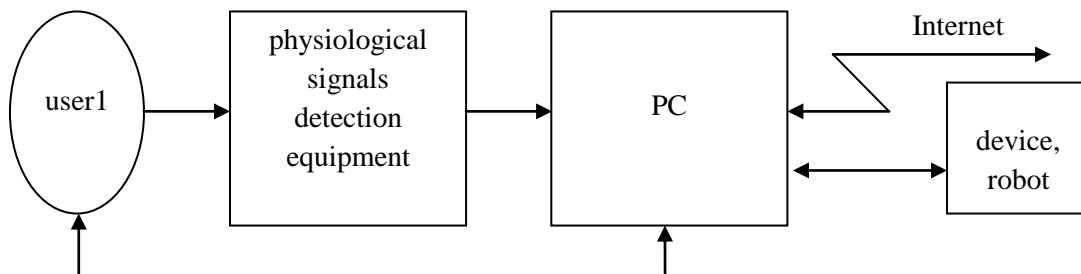
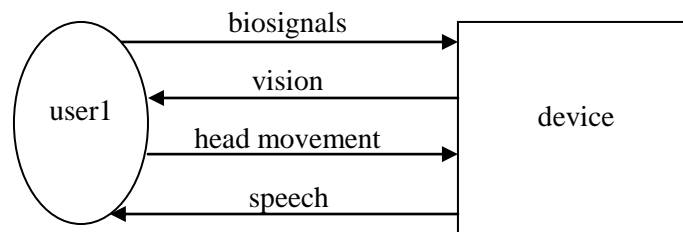

Figure 1.3. Device control using EI-HCI

### 1.2.4. Hands-Free Control Scenarios

Hands-free interface is a special type of device control where hands are not used. The hands are either busy with another task or are not operational due to injury.

It is a challenging application area of prosthetics for the handicapped, a need for additional way of control when the hands are busy, and for controlling devices simply using the mind. A type of hands-free interface is the head-computer interface, where devices are controlled using signals from the head only. Usually, the signals are recorded in the form of EOG (electrooculogram) and EEG, but other signals, for example recorded in the form of electromasticatiogram (EMCG) might also be used. Vision and speech are also used. Figure 1.4. shows a hands-free control scenario in which control is achieved from signals generated by a human head.



*Figure 1.4. Communication between a human and a device using head signals only*

A special class of device control using EI-HCI is the brain-computer interface (BCI), where brain signals are used for device control, which will be considered in the next chapter.

## **Chapter 2**

# **BRAIN-COMPUTER INTERFACE**

This chapter elaborates on the subject of brain-computer interface (BCI). The concept is introduced, alongside its history, and also its components are given. The signal acquisition techniques are presented, and its operative procedures are explained. The specifics of signal processing are explained, how one such interface's success is measured, and also what are the present and possible future applications of such interfaces.



## **2. BRAIN-COMPUTER INTERFACE**

A special type of Human Computer Interaction is the Brain Computer Interface. *Brain-Computer Interface* (BCI) is a system that can derive meaningful signals from a human (or animal) brain, and utilize them for control purposes in real time or near real time. In other words, this system utilizes *brain states* to control a device, bypassing the need for motor organs, such as arms or legs, or even speech. In a BCI, direct bioelectric control [Bozinovski , 1990] is used to control devices. Using a BCI, the device controlled by the brain becomes a sort of an “organ” of the body, and a possibility of using BCIs in prosthetic control immediately becomes apparent. Indeed, most applications of BCI are related to subjects with severe neuromuscular disorders, where a BCI offers them basic operative abilities. It has been shown how a BCI can control a spelling program, operate a neuroprosthesis, and control a wheelchair.

Depending on the technique used to extract brain signals, the BCIs can be classified into *non-invasive* (where the signals are collected from the subject’s head, i.e. using peripheral electrodes) and *invasive* (where the signals are collected directly from the subject’s brain, i.e. the skull is opened and electrodes are implanted into the brain). Historically, non-invasive BCIs have appeared first.

### **2.1. History of BCI**

Brain-computer interface is today a rapidly growing area. Thousands of papers can be found on the Internet related to the subject. It is interesting however, that before the 21<sup>st</sup> century there were just a few papers related to the subject. Here just a few of the papers are listed which can be considered the milestones in BCI history.

EEG was first introduced by Berger [1929]. Possibility of controlling devices using EEG was mentioned by Vidal [1973]. Alpha rhythm was proposed to be used by Osaka [1984]. The concept of mental prosthesis was introduced by Farwell and Donchin [1988]. The first control of a mobile robot using EEG alpha rhythm took place in Macedonia [Bozinovski et al, 1988]. In the 1990s [Keirn and Aunon, 1990], BCI experiences its renaissance. A cursor was moved on a computer screen using EEG [Wolpaw et al, 1991]. The term Brain-computer interface was introduced by Pfurtscheller et al. [1993]. The importance of digital signal processing in BCI was emphasized by McFarland et al [1997]. Alpha rhythm was again used as a mind switch [Craig et al., 1997]. The concept of imaginary voluntary movement-related potentials (IMMRP) was introduced by Mason and Birch [2000]. Imagination of different simple hand and feet movements were used [Pfurtscheller and Neuper, 2001]. Cognitive processes based BCIs were introduced starting 2000. A P300 based BCI was proposed by Donchin et al [2000]. An invasive BCI built upon an animal's brain was introduced by Nicolelis and Chapin [2002]. A BCI based on anticipatory brain potentials was introduced by Božinovski [2005]. In 2008, a BCI based on anticipatory potentials was used for device control by Gangadhar et al [2008]. In 2009 a BCI based on anticipatory potentials was used for robot control by Božinovski and Božinovska [2009].

## 2.2. Components of a BCI

A brain-computer interface paradigm (setup and procedures) consists of a subject that generates brain signals, a computer that contains software for brain signal processing, and a device that would be controlled by those brain signals. The basic components of a BCI were introduced since 1988 [Bozinovski, 1988]. Figure 2.1. shows the modern version of the basic BCI components. Since a BCI must operate either in *real-time* or *near-real-time*, it is important that the signal processing not introduce unacceptable time delays.

A BCI has the following basic components:

**Brain mental state.** The brain's mental state or intention is reflected in its bioelectric field. This mental state is to be recognized and interpreted as an action to be performed by the device; an example is moving a robot forward.

**Signal acquisition device.** Usually this is a potential amplifier and analog-to-digital converter, that augments the input capability of the computer. It collects the EEG data in which the desired or expected event related signal is hidden within other bioelectric phenomena, so-called background EEG.

**Signal preprocessing software.** This part of the BCI filters out the signal to be processed. Usually preprocessing filters out the power network signals (e.g. 220 V, 50 Hz.), and artifacts due to movement of the subject. Incorporation of rejection criterion to avoid risky decisions is an important issue in BCI.

**Mental state related signal extraction software.** The next part of the BCI is the mental state related signal extraction. For example, if the mental state used is the relaxation state, then the EEG alpha rhythm, for example, will be sought and extracted, because it indicates a relaxed state.

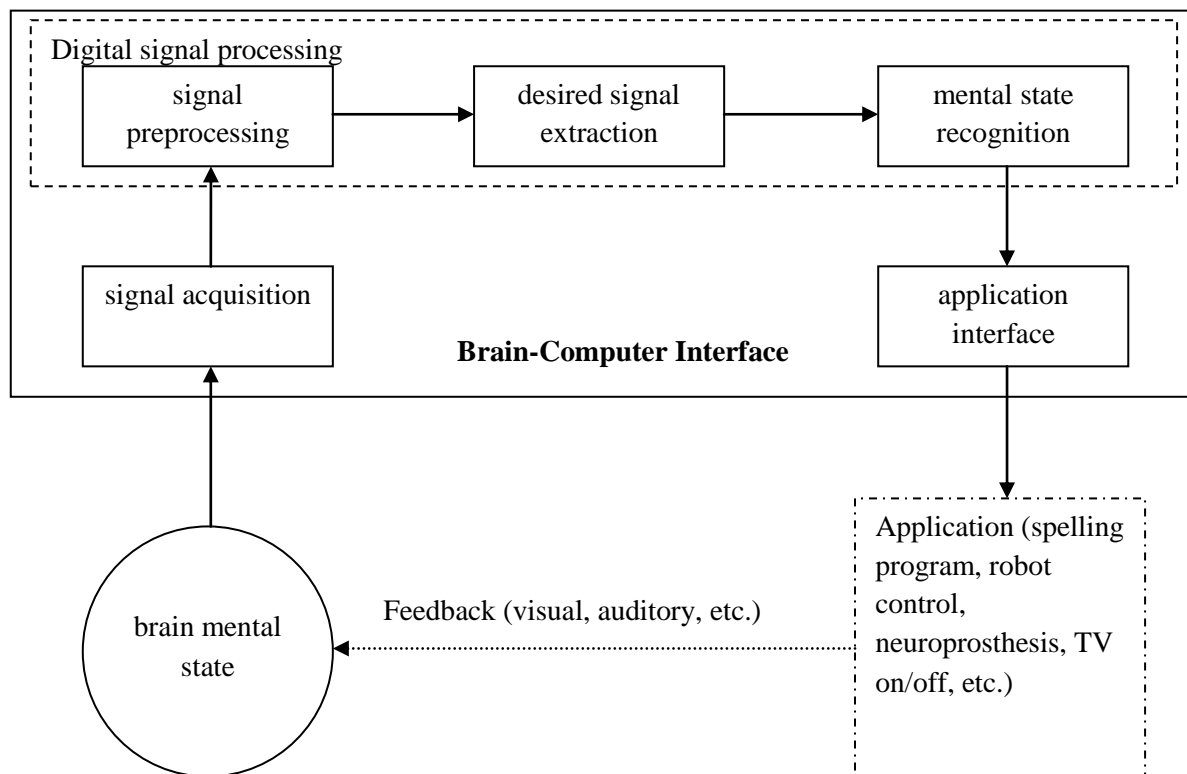

*Figure 2.1. Basic components of a BCI*

**Mental state recognition software.** The pattern recognition and interpretation software is the part of the BCI that makes a decision whether the particular sought brain state is present in the subject’s brain. For example, whether “the state of brain relaxation” is present. This is the decision part, and must implement decision algorithms, because it’s very possible that the signal be random noise, misinterpreted for a relaxation state, for example.

**Application interface software** sends appropriate control signals as commands to the controlled device. If the device is a robot, it might be a “go forward” command, for example.

**Controlled device.** The device is connected to the computer via a communication port. It can be a parallel, serial, or a USB port. It can also be a software device, such as a cursor on the screen or an animation object.

**Feedback connection.** The subject is able to receive feedback from the command it sends through its EEG, usually by visual and/or sound means.

### 2.3. BCI Signal Acquisition Techniques

There are two major technologies of signal acquisition in BCI: invasive and non-invasive.

**Invasive technologies** are used on animals. They are basically open-brain BCIs, with recordings directly from the brain tissue. Studies that deal with algorithms for movement reconstruction from the motor cortex neurons date from the 1970s. It has been established that monkeys can quickly learn to control the frequency of individual neurons in the primary motor cortex, after closed-loop operational conditioning [Schmidt et al, 1978].

Great progress has been accomplished when, in the late 1980s, a mathematical connection was established between electric responses of individual motor cortex neurons in monkeys and the direction in which the monkey moved its arms. It was also noted that dispersed groups of neurons in different areas of the brain collectively control motor commands [Georgopoulos et al, 1989].



*Figure 2.2. An example of a BCI experiment on animals [1]*

In 1999, researchers led by Yang Dan at University of California, Berkeley decoded neuronal firings to reproduce images seen by cats. The team used an array of electrodes embedded in the thalamus (which integrates all of the brain's sensory input) of sharp-eyed cats. Researchers targeted 177 brain cells in the thalamus lateral geniculate nucleus area, which decodes signals from the retina. The cats were shown eight short movies, and their neuron firings were recorded. Using mathematical filters, the researchers decoded the signals to generate movies of what the cats saw and were able to reconstruct recognizable scenes and moving objects [Stanley et al, 1999].

By the year 2000, a BCI has been developed, which reproduced monkey movements while the monkey was controlling a joystick or reaching for food [Wessberg et al, 2000]. The BCI functioned in real time and could also control a separate distance robot over the Internet. After 2000, a feedback system has been introduced, so that the monkeys could see the results of their actions

themselves. Figure 2.4. shows the experimental setup of the group led by Nicolelis [Nicolelis and Chapin, 2002].

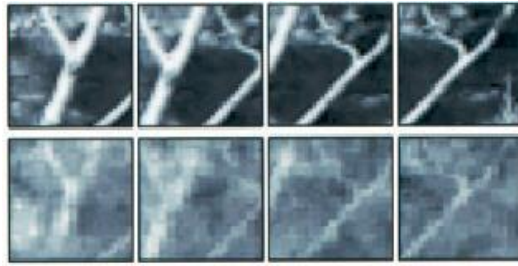

Figure 2.3. An example of image reconstruction based on neuron activity [2]

The monkeys practiced reaching and grasping of objects on the computer screen by handling a joystick, while the appropriate movements of the robotic arm were hidden from the view of the monkeys. [Carmena et al, 2003; Lebedev et al, 2005]. The monkeys then controlled the joystick while watching the robot movements, and thus were able to learn what the robot movements were. This BCI used speed prediction to be able to control arm extension and also predicted the strength of the grasp. The result was that the monkeys, after a number of practice sessions, were able to control the robotic arm using the brain alone, and use it to put food in their mouths.

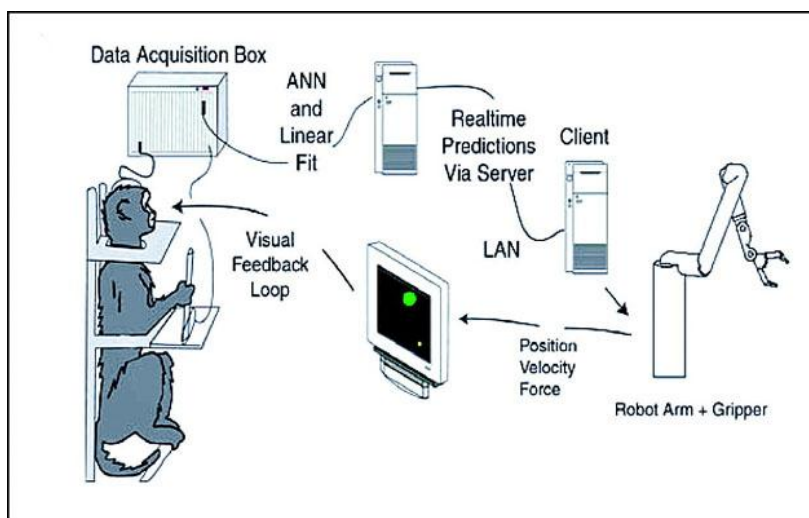

Figure 2.4. The BCI set by Nicolelis et al [3]

In humans, invasive BCI technologies are most commonly used in the area of neuroprosthetics, where a disabled organ's functionality can be compensated by a BCI receiving signals from the brain. One of the first uses of invasive BCIs in humans for this purpose was to restore vision in patients blinded in adulthood, led by a private researcher named William Dobbelle. Cameras would record images, which would be driven directly to the vision center of the brain, stimulating it and enabling

it to restore images. The most prominent example of such a use was Jens Naumann, a man blinded in adulthood, who purchased Dobelle's implant (which was then released as an improved, second version), and was able, with his restored vision, to drive a car slowly on a parking lot.

Usually, the implants used in invasive BCIs consist of multiple electrodes arranged close to each other, since the proximity to the brain allows much more intensive signal collecting. Invasive BCI technologies can collect signals that are with less noise and potentially easier to process. The processing is usually faster. The information rate can be increased through surgical implantation of microelectrodes, which record the activity of more localized populations of neurons. The problems appear when the signals should be collected for a prolonged period of time - the brain's protective tissue envelops the electrodes and the signal becomes noisy, so the advantage over non-invasive technologies is lost.

The invasive techniques were used to extract relevant signals that are encoded in the distributed and redundant way by ensembles of neurons in the motor part of the motor, premotor and posterior parietal cortex.

**Non-invasive technologies** collect signals from the scalp surface. The classical technology is the *electroencephalography (EEG)*, which collects a state of the electric field of the brain. The first experiments were shown in 1988 [Bozinovski et al, 1988]. Non-invasive techniques suffer from reduced spatial resolution and increased noise, due to fatty regions on the surface of the scalp. As a consequence, current EEG-based brain actuated devices are limited by a low channel capacity and are considered too slow for controlling rapid and complex sequences of robot movements. But recently it has been pointed out that online analysis of an EEG signal, if used in combination with advanced robotics and machine learning techniques, is sufficient for humans to continuously control a mobile robot [Millán et al, 2004] and a wheelchair [Galan et al, 2008].

Today often used, even simultaneously with EEG, is the *near-infrared microscopy*. It obtains an image of the blood from in the brain in the infrared spectrum (700 – 1200 nm). A technology that shows the magnetic field of the brain is *magnetoencephalography (MEG)*. A version of MEG is *functional magnetic resonance imaging (fMRI)*, which focuses on the magnetic field generated by event related magnetic fields. Another imaging method is *Positron Emission Tomography (PET)*, which follows radioactive material inserted into the blood system as it appears in the brain.

In this work, the EEG non-invasive technology is used, as it is most readily available, being easy transportable and cheap. Other technologies are expensive, static and heavy and are therefore only used in specialized laboratories.

## 2.4. BCI Training and Calibration Sessions

A critical issue for the development of a BCI is training, i.e. how users learn to operate the BCI. Usually, the BCI needs a session in which both the subject and the BCI itself will engage in an adaptation process, in which the subject intention (brain state) will be determined in terms recognizable by the BCI. There are two basic approaches to how adaptation is carried out.

One approach is the *subject learning to voluntarily regulate the brain activity*. Such techniques usually involve neurofeedback and operant conditioning. There is an explicit *subject training session*, in which the subject learns to regulate a specific brain activity. After the training, different *brain states* can be produced on command or by the subject's will, and become suitable as control commands. For example, a subject concentrates on a parameter (such as the EEG alpha wave) and tries to voluntarily control that parameter. In a series of trials, he/she attempts to increase or decrease that parameter and receives feedback at the end of each trial. After the training, the subject should be able to voluntarily increase or decrease the parameter of interest. This way, using this approach, the subject adapts to the machine.

Another approach is *machine learning*, in which statistical data is collected in so-called *calibration sessions* (for example 5 to 20 min). In that session, the subject tries to voluntarily produce a brain state that a computer can recognize, for example a voluntary signal of intent to raise a hand. The computer collects statistical data and recognizes the signal generated by the subject. In the calibration process, the brain state recognition software adapts to the subject's parameters. The statistical signature of specific brain states or intentions is obtained. That signal is then used in the real experimental (examination or exploitation) session that follows the calibration session. This way, the machine adapts to the subject.

The combination of the two basic approaches can also be used. An example is the mutual learning approach to accelerate the user training period [Pfurtscheller and Neuper, 2001; Blankertz et al 2006]. The user and the BCI are coupled together and adapt to each other. Machine learning approaches are used to discover the individual EEG pattern characterizing the mental task executed by the user, while he/she learns to modulate his/her brainwaves so as to improve the recognition of the EEG patterns.

## 2.5. Brain States Used in a BCI

So far, the following brain states have been used in BCI design (Figure 2.5.).

**Relaxation state.** A relaxed brain state can be observed when the eyes are closed. In that case, the EEG frequency band named alpha rhythm (8-12 Hz) increases its energy, i.e. amplitude. The alpha rhythm is measured mostly in the occipital brain region. The amplitude increase of the alpha rhythm has been used as

mind switch in the pioneering work of BCI [Bozinovski et al, 1988; Bozinovski, 1990]. Detailed study of the subject was done by Searle [2000].

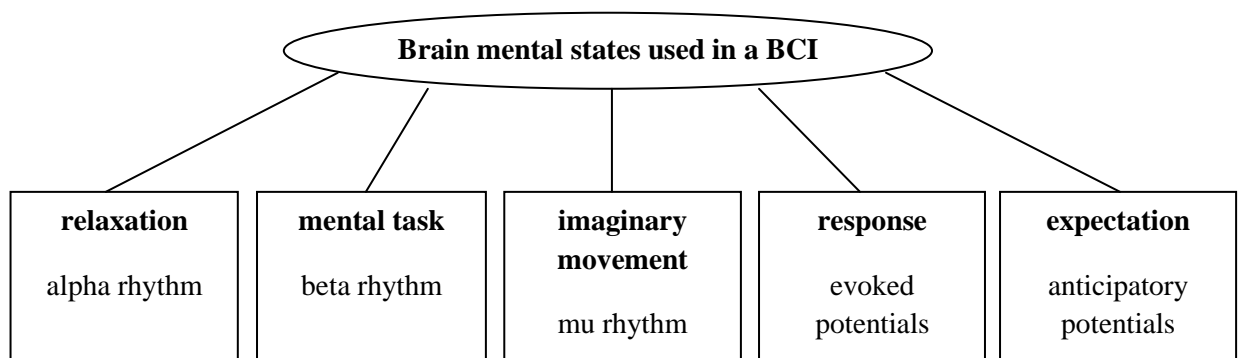

Figure 2.5. Brain mental states used in BCIs

**Mental task performing state.** Mental task-based BCIs are based on EEG analysis while the subject performs a mental task at her/his own will. Possible mental tasks are computing an arithmetic task, rotating an image, or some language related task [Millán et al, 2004]. But for steering a wheelchair or a robot or prosthesis, voluntary mental control is not enough. It is also necessary that the subject be able to make self-paced decisions. In such asynchronous protocols, the subject can deliver a mental command at any moment, without waiting the external cues.

**Imaginary movement/Intention to move state.** Imaginary movement of hands and feet also produces specific EEG patterns. The intention to move produces increased energy in the EEG frequency band of 8-12Hz in the motor region. It can also be denoted as alpha ( $\alpha$ ) rhythm, but the term mu ( $\mu$ ) rhythm has often been used. One of the techniques used is the imagination of different simple hand and feet movements, which are associated with different EEG patterns [Pfurtscheller and Neuper, 2001]. The related mental process (motor imagery) is identical to the process that results in an actual physical movement, except that the motor (muscle) activity is blocked.

**Responding state.** If a set of patterns is shown to a brain and a special pattern is recognized, a P300 signal appears as a bioelectrical signal of recognition. The most impressive application of a BCI is indeed the one based on P300 [Wang et al, 2006]. Letters appear on a screen in front of a subject. Whenever a particular letter of interest appears, P300 is present and the letter is singled out and put in a string with previously selected letters. In such a way, the mind is used as a typewriter to print a message. This way, an evoked BCI exploits the signal that appears as an automatic response of the brain to an external stimulus. Examples are the P300 and SSVEP (Steady-State Visually Evoked Potential). Evoked potentials are relatively easy to extract, but the necessity of an external stimulus restricts the applicability of evoked potentials.



**Learned expectation state.** If a pair of stimuli is present repeatedly, the brain quickly learns that after the first one the second one follows and generates expectancy after the first stimulus, expecting the second one. This expectancy is generated as an expectancy brain wave, known as CNV (contingent negative variation) potential. The CNV potential was used in BCI applications since 2005 [Božinovski, 2005].

## 2.6. Signal Processing in BCI

A BCI, by employing signal processing techniques, translates the EEG signal characteristics into commands which control a device. In addition to implementing standard signal processing techniques, here, two important features of BCI signal processing will be mentioned. One is extracting spectral features from an EEG signal and the other is building a classifier that will recognize the mental states and translate them into device commands.

**Extracting spectral features from the EEG signal.** The most common technique for extracting features from an EEG signal is to analyze the spectral power in different frequency bands [McFarland et al, 1997]. Spectral analysis of a single channel may be useful, although multichannel analysis is preferable, since it accounts for spectral variations associated with different types of motor imagery; for example, differences between the hemispheres can be exploited by multichannel analysis. The frequency bands are selected in such a way, so that they reflect the EEG rhythms of interest: the alpha ( $\alpha$ ), mu ( $\mu$ ) rhythm and beta ( $\beta$ ) rhythms have been found particularly useful for BCI use. The mu and beta rhythms are usually recorded from the sensory-motor cortex, i.e. the area which is primarily responsible for the control of hand and foot movement, whereas the alpha rhythm is recorded at the occipital region.

**BCI pattern classifier building.** In order for the BCI to learn the meaning of different EEG signal characteristics, the subject is instructed to imagine or apply one of several actions. For each of the actions (imagined or real), a set of features is extracted from the EEG and submitted to a classifier. By repeating the imagined actions several times, the classifier can be trained to determine which action is chosen. Subsequent to the learning phase, the BCI relies on the classifier to translate the subject's action (motor imagery, relaxation, expectation, etc) into device commands, such as selection of a letter in a spelling program. The learning phase of a BCI should be repeated on a regular basis. Since the EEG exhibits considerable variability due to factors such as time of day, hormonal level, fatigue etc, it is necessary to adjust the classifier in order to maintain an acceptable level of performance.

Brain signals are usually very slow. Commonly, the signals arrive at a rate of one bit per second, which means that controlling a complex sequence of actions at that rate would be difficult. The solution is to use behavior based control, where rather complex behaviors are executed by device intelligence and just start/stop of a

particular behavior is executed by a brain command. So the key element is to combine a subject's mental capabilities with device (machine) intelligence. The subject delivers high level commands such as "stop following the line" or "turn right at next sensor signal" and the robot executes it. The subject just delivers the intent, and the robot executes it when needed with smooth trajectories. An example is steering a wheelchair or a mobile robot.

## **2.7. Measure of a BCI Success**

The overall success of a BCI depends on how well the two adaptive systems – the user and the BCI system – are able to interact with each other. The user must develop and maintain good correlation between her/his intent and the signal features used in the BCI. The BCI system must extract the signal features that the user can control and translate them into commands correctly.

The performance of a BCI may be measured in terms of information transfer rate, which is defined in bits per minute. The performance depends on the accuracy with which the different mental states are classified. At present, a sophisticated BCI is not able to decipher more than 10-25 bits/min – an information transfer rate which could enable a completely paralyzed subject to write approximately two words per minute. However, these rates are much too slow for the control of complex movements or the interaction with neuroprosthesis.

Low classification error is a crucial performance criterion for BCI; otherwise the users become frustrated and stop using it. Furthermore, not executing probable wrong commands improves robot performance. The users should not need to turn either a robot or a wheelchair back in order to continue toward the desired trajectory.

## **2.8. Examples of Applications**

The most successful application so far seems to be the "thought-controlled typewriter", a system that can pick up a letter from the alphabet, then another one and so on, and thus synthesize a text. It uses the P300 potential that appears when the subject recognizes a particular desired/expected letter in a series of letters. Once the letter is recognized, it is added to an evolving word or sentence. The latest version is developed by the Fraunhofer Institute in Germany.

Mobile robot control was the first application of BCI [Bozinovski, 1988], and was basically repeated in 1997 [Craig et al, 1997; Searle, 2000]. The application gained momentum in 2004, when Millán et al [2004] experimented with two subjects that learned to move a robot in a house-like environment using 3 or 4 rooms in the desired order. Later the subjects learned to perform the same task manually and the performance was only slightly better than when it was executed mentally. Report on wheelchair control was given in 2008 [Galan et al, 2007].

Robotic arm control was first reported as an application of the invasive BCI [Nicoletis and Chapin, 2002]. In 2007, the Fraunhofer Institute for Computer Architecture and Software technology (FIRST) and Charité Hospital in Berlin, Germany, reported using EEG signal to control a robot arm. The software analyzes the normal EEG recording and, using self-learning techniques, extracts the proper features. When the movement is carried out, the software notices changes in the EEG, i.e. it recognizes the intention to raise the left and/or right hand. Other robotic arm control experiments were also reported [Božinovski, 2009].

## **2.9. Challenges and Future Directions**

The most challenging application is real-time control of brain actuated robots. From the experiments shown, three commands are often enough to control robots, especially using shared intelligence. Further increase of the number of commands is one challenge for future work.

Another challenge is lowering the error rate of the BCIs. A common source of error is the non-stationarity of brain signals. One solution is online adaptation of a BCI to a subject's performance [Bozinovska et al, 1992; Millán, 2007]. Another approach is to use a subject's cognitive abilities to detect errors directly from their EEGs. Single-trial error potential recognition is used, in which the subject becomes aware a millisecond after the erroneous response of the BCI [Ferrez and Millán, 2008]. User commands are only executed if no error is detected in that short time, increasing the BCI performance. This error potential provides performance feedback which, along with online adaptation, allows improving of the BCI while being used.

Most of the time, ERPs are extracted using averaging techniques. These techniques are easy implemented and can be readily available to most researchers. However, the downside is that fast mental commands cannot be executed; normally, EEG signals are filled with noise and artifacts, and extracting the meaningful signal directly from the raw EEG is normally very difficult. A solution [Jung et al, 2001] is to record from multiple electrodes on the head and face and extract components from those recordings. This way, "pure" EEG signals can be separated from "pure" EOG signals, for example, and thus the effects of EOG to EEG can be easily established and corrected, if necessary. This technique is called Independent Component Analysis (ICA) and requires laboratory conditions.

Another way is usable if the sought signals are relatively well-known, i.e. prior knowledge about their nature exists. Such well known signals are for example finger flexion signals, eyes movement signals etc, that are of the same shape and form in all human subjects. This can then be used to create a Bayesian classifier, which can discriminate between whether the signal is accepted as a finger flexion signal (within determined margins of error) or not [Kohlmorgen and Blankertz, 2004].

## **Chapter 3**

### **BRAIN POTENTIALS**

Brain potentials are described in this chapter, mainly viewed through their EEG recordings, and their frequency analyses. The origins of brain potentials are also described. Afterwards, the brain potentials are classified and attention is given to the spontaneous and evoked event-related potentials. Finally, their relations to cognitive science and brain functioning itself are discussed.

## **3. BRAIN POTENTIALS**

### **3.1. Electroencephalogram (EEG) and Spontaneous Brain Activity**

Electrical signals from the brain surface or the outside head surface demonstrate continued electrical activity in the brain. Both the intensity and form of this electrical activity are to a large degree determined by the total level of brain excitation, which is the result of sleeping, awareness, as well as some brain dysfunctions, such as epilepsy or some psychoses. The oscillations in the registered electrical potentials are called *brain waves* or *brain potentials*, and an entire collection of such signals is called an *EEG (ElectroEncephaloGram)*.

Originally, EEG was, and still is, used in medical diagnosis to diagnose mental retardation, sleep disorders, degenerative diseases such as Alzheimer's disease and Parkinson's disease, and mental disorders such as autism and schizophrenia. This chapter deals with the medical nature of brain potentials.

Brain potential intensities on the skull surface range from 0 to 200  $\mu\text{V}$  (microvolts), and their frequencies range from 1 wave per several seconds to more than 50 waves per second, i.e. 50 Hz (hertz). The characteristics of these waves depend greatly on the cerebral cortex activity, as well as the cumulative health status of the body.

Brain potentials can be registered on any point on the scalp. Still, there are standards that recommend recording on specific points, so the measurement results obtained in one laboratory could easily be compared to measurements in another laboratory. The most commonly used such system is the 10-20 system, shown on Figure 3.1. By this system, twenty electrodes are used for standard clinical EEG recording, although extensions for this system have been introduced as well.

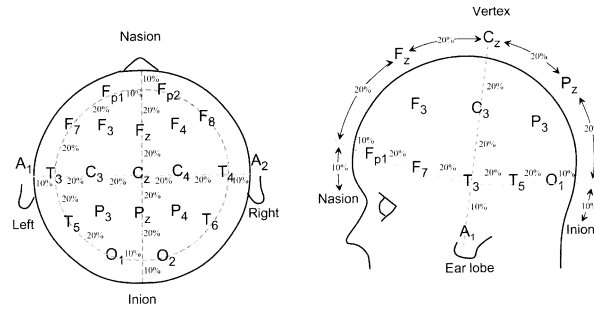

Figure 3.1. The placement and notation of electrodes according to the standard 10-20 system

The anatomical reference points have been defined as the *nasion* (the top of the nose) and the *inion* (the lump at the back of the skull). The letters used are F(rontal), P(arietal), C(entral), T(emporal), O(ccipital), and A(uricle). Odd numbered electrodes are on the left side, even numbered on the right side, and z-indexed are along the midline.

Signals are recorded between two electrodes, e.g. Cz and A<sub>2</sub>, whereas the third electrode is neutral (ground) electrode for example placed Fp<sub>2</sub>. Contemporary technology allows simultaneous recordings from several electrodes and presentation of the measurements as an electric field (topographic map) of the brain (Figure 3.2.).

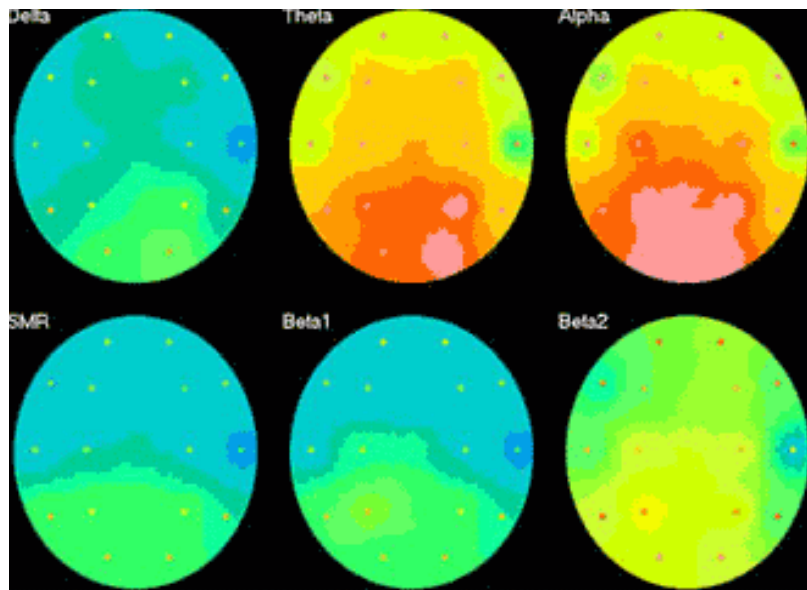

Figure 3.2. Topographic maps of the brain [4]

## 3.2. Frequency Analysis of EEG

Brain waves are mostly irregular in shape and a standard EEG pattern cannot be defined. However, frequency analysis (i.e. Fourier analysis) shows that some frequencies are more prominent within the EEG. Traditionally, patterns of waves within the EEG have been discovered and defined, that have been called *alpha*, *beta*, *gamma*, *delta* and *theta* waves. Alpha and beta waves were introduced by Berger 1929. Gamma waves were introduced in 1938 to refer to brain waves above 30 Hz. Delta rhythm was introduced in 1936 to designate waves below alpha rhythm. Later the delta range was divided into two ranges with introduction of theta rhythm.

Commonly, the standard EEG components are extracted and analyzed in the frequency domain. Figure 3.3. shows a subject EEG, which has his eyes closed, in time domain and in frequency domain. Figure 3.4. below shows the corresponding analysis in frequency domain when the eyes are open.

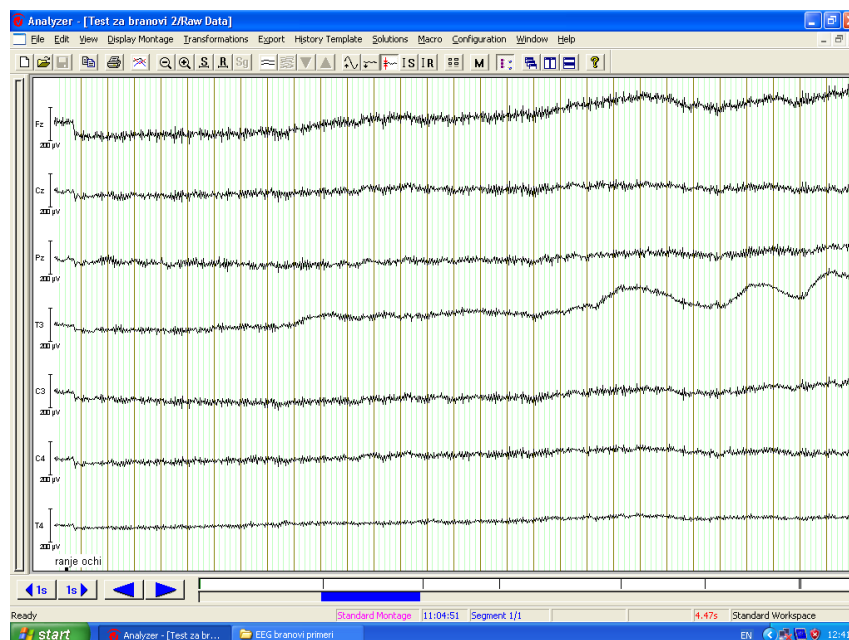

Figure 3.3. EEG from the subject's head, eyes closed, shown in the time domain

On Figure 3.4. it is easy to notice that if the subject's eyes are closed, the alpha waves have relatively higher amplitudes. The Figure also shows that the EEG may also contain a DC component (frequencies around 0 Hz), which may originate from artifacts caused from the process of measurement or the signal itself.

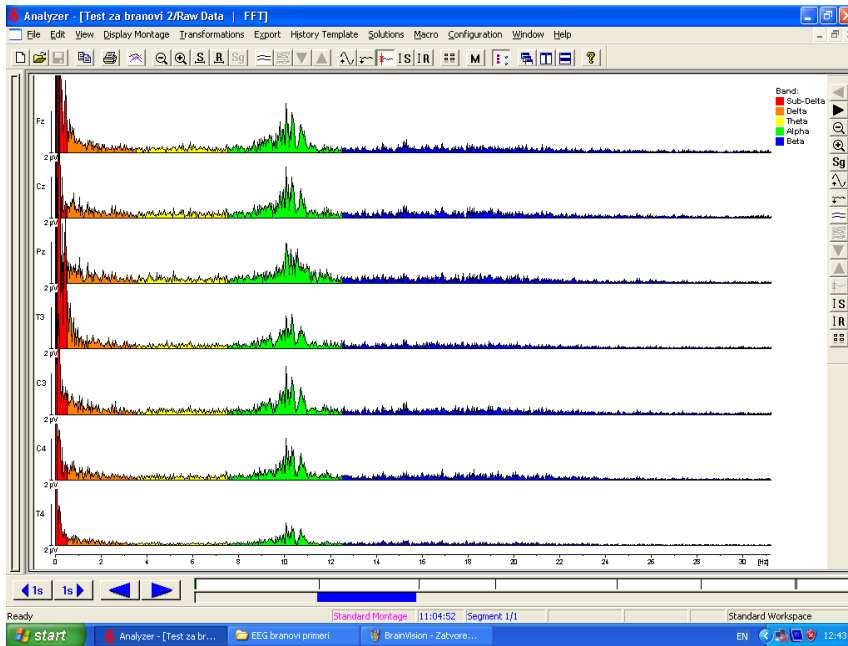

Figure 3.4. Fourier analysis of Figure 3.3.

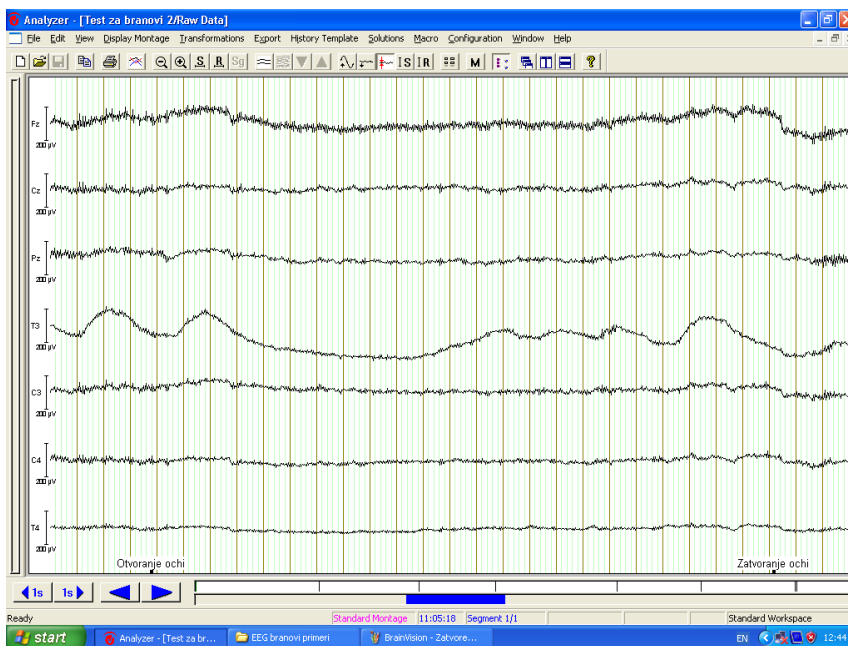

Figure 3.5. EEG from the subject's head, eyes open, shown in the time domain



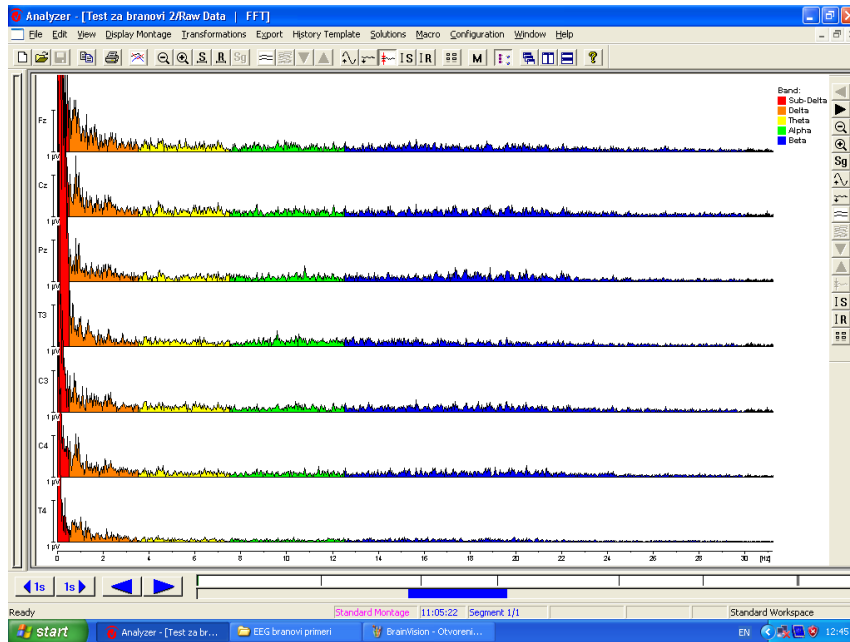

Figure 3.6. Fourier analysis of Figure 3.5.

Figure 3.6. shows that when the eyes are open, the alpha waves are not so prominent, but the beta waves come more into expression.

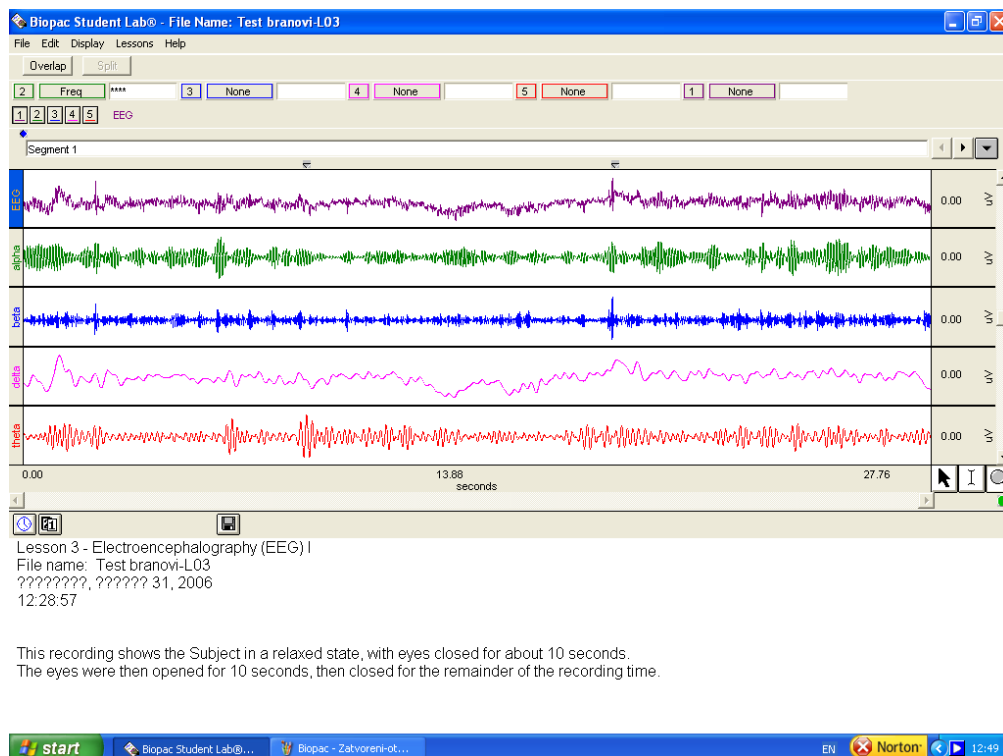

Figure 3.7. EEG and its traditional brainwaves, extracted in the time domain

With contemporary computer technology it is possible to filter out the brain waves and show them in parallel to the EEG from where the frequency components

are extracted. In Figure 3.7., an EEG signal is shown, along with the follow-up components of the frequency spectrum, which correspond to the alpha, beta, delta and theta waves.

### 3.3. Characteristics of EEG Waves

The *frequency-amplitude coordinate system* of brain waves is shown on Figure 3.8. Following is the description of characteristics of those waves [Guyton and Hall, 2000].

*Alpha waves* are rhythmical waves, which exist at frequencies between 8 and 13 Hz and can be found in the EEG of almost all normal, healthy adults, when they're awake. These waves are most intensively found in the occipital region when the subject is relaxed with eyes closed, but can also be registered from the parietal and frontal regions. Their voltages are about 50  $\mu\text{V}$ . During deep sleep, alpha waves diminish completely. When the attention of the awake subject gets focused on a specific type of mental activity, the alpha waves get replaced with asynchronous waves of a higher frequency, but lesser voltage, i.e. beta waves.

When the alpha waves frequency range is recorded from the brain motor area, a rhythm appears, the positive wave of which is rounded (i.e. corresponds a sine wave) but its negative part is sharp. This is called the *mu* wave. While the alpha wave is associated with idling activity of the visual cortex, the mu wave is associated with idling activity of the motor cortex.

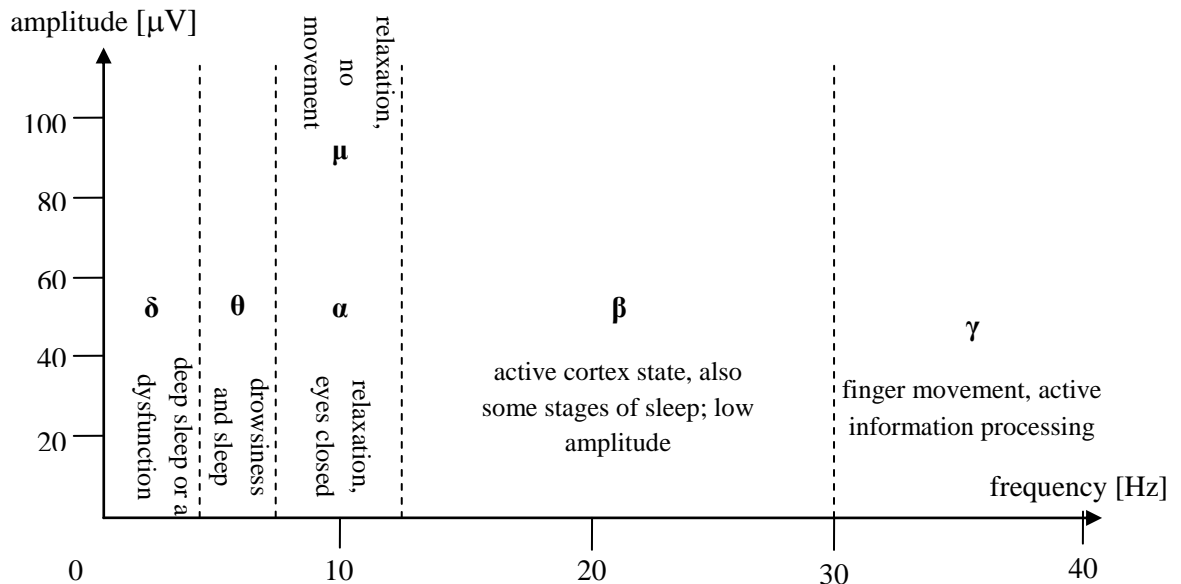

Figure 3.8. The frequency-amplitude coordinate system of the brain waves , and their characteristics

*Beta waves* have frequencies higher than 14 Hz, up to as many as 80 Hz. They can most commonly be registered at the central and frontal skull regions, during extensive activation of the central nervous system or during tension.

Some researchers divide the beta range into two parts: beta waves are between 14-30 Hz, and above 30Hz are *gamma waves*. Gamma rhythms are recorded in the near sensory-motor area. Sensitive recording technique is required.

*Delta waves* are considered all EEG waves below 3.5 Hz and they commonly have voltages two to four times higher than of other types of brain waves. They can be detected during very deep sleep, early childhood and serious organic brain diseases. In normal persons, since they are low frequency waves they appear as a carrier (near DC) component of the EEG. Muscle movements can produce artifacts in the delta range.

*Theta waves* have frequencies between 4 and 7 Hz. They emerge mainly in the parietal and temporal regions in children, but also during emotional stress in some adults, especially during disappointment and fear. They also emerge in transition from conscious states toward drowsiness as well as in many brain diseases, often in degenerative states.

In addition the above described waves of the spontaneous EEG, other waves are mentioned by various researchers [Sanei and Chambers, 2007].

### 3.4. Effects of Various Degrees of Brain Activity to the Basic EEG Frequency

There is a general relationship between the degree of cerebral activity and the average frequency of electroencephalographic rhythm, where the average frequency rises progressively along with the higher degrees of activity. This is shown on Figure 3.9. [Guyton and Hall, 2006], which shows that the EEG frequency rises with the increased brain activity and vice versa.

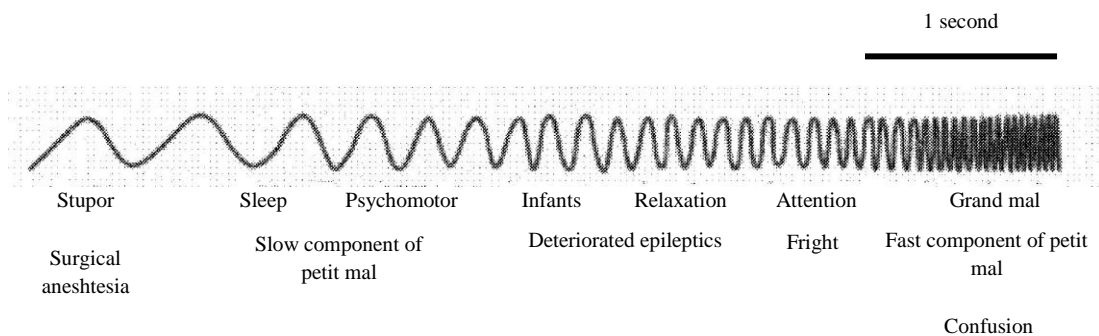

Figure 3.9. Relation of brain frequencies to brain states

During the period of mental activity, the waves become more asynchronous than synchronous, so the voltage drops significantly, despite the expressedly increased cortical activity, as shown on Figure 3.10. The Figure shows the increase of amplitude of alpha waves in the relaxation state (eyes closed) and higher frequency activity when the eyes are open and observe an event.

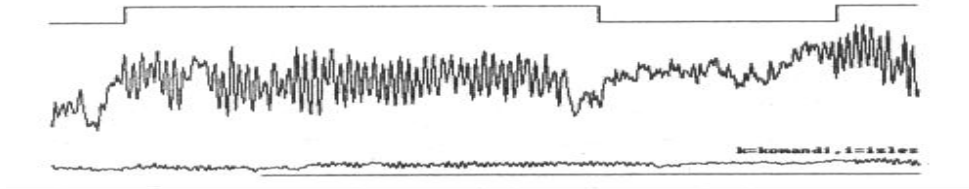

Figure 3.10. Noticeable difference in brain dominant frequency in relaxation state (alpha rhythm) and event observing state [Bozinovski et al 1988]

*The origin of alpha waves.* Alpha waves won't emerge in the cortex without their links with the thalamus. Also, a stimulation in the non-specific reticular nuclei, that surround the thalamus, as well as “diffuse” nuclei deep in the thalamus, often generates waves in the thalamocortical system of frequencies between 8 and 13 Hz, which is the natural frequency of alpha waves. Therefore, the alpha waves probably originate from the spontaneous backward oscillations in the diffuse thalamocortical system, with possible participation of the activation system of the brain stem. This oscillation causes also the periodicity of the alpha waves and the synchronous activation of literally millions of cortical neurons during each wave. Still, in general, today one might say that the origin of alpha rhythm is still “at large”, and needs more research.

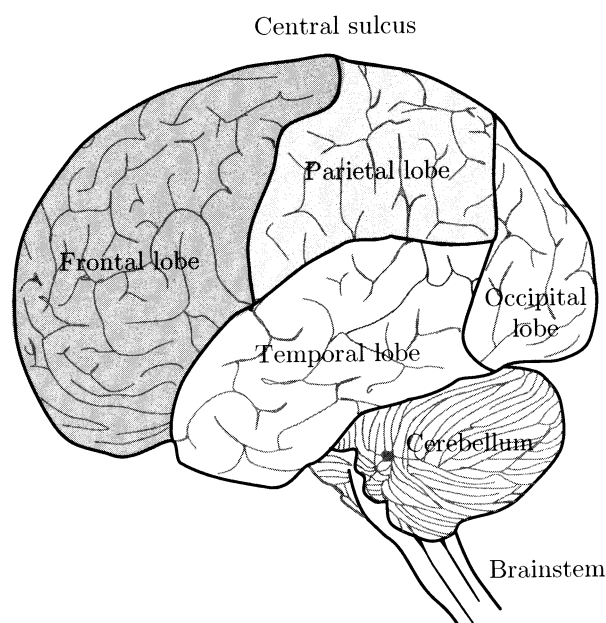

Figure 3.11. Basic anatomical localization of the brain

*The origin of beta waves.* Beta waves emerge during active and conscious state of the brain, where actions are performed. Curiously, beta waves emerge also in deep sleep. It is known [Austin, 2006] that there are two kinds of beta rhythms: slower beta (15-18 Hz), associated with slow wave sleep, and faster beta, or so-called beta-2 (higher than 18 Hz), that occurs during active waking states and states of rapid eye movement (REM) sleep. Curiously, the beta-2 activity accompanies states of “spontaneous cognitive operations”, that occur during “conscious rest” in the “absence of a task”. Following this, the beta-2 activity during REM sleep can be considered as a sort of “defragmenting of the brain” and rearranging of the obtained information during the wake period, so as it would be organized and processed accordingly. Most commonly, the beta waves originate in the medial cortex of the retrosplenial and dorsomedial prefrontal regions, as well as the lateral temporoparietal region [Austin, 2006].

*The origin of delta waves.* Trans-section of the nerve fibers from the thalamus to the cortex, which blocks the thalamical cortex activation and thus removes alpha waves, does not cause a blockade of all the delta waves in the cortex. This indicates that some synchronization mechanism can be carried out in the cortical neurons themselves – completely independently of all the lower brain structures – causing delta waves. Delta waves also exist in very deep “slow-wave” sleep; this suggests that the cortex is then mainly free from activation influences of the thalamus and other lower centers. They can be found in the animal cortices with sub-cortical trans-sections, which separate the cerebral cortex from the thalamus. Thus, delta waves can exist in the cortex itself, regardless of the lower brain region activities.

*The origin of theta waves.* Theta waves have been found in cortical limbic areas (such a hippocampus, entorhinal cortex, and cingular areas). These areas generate slow rhythmical activity in the frequency band of the theta waves. [Artamenko, 1972; Lubenov and Siapas, 2009]

### **3.5. A Taxonomy of Brain Potentials**

Alpha, beta, theta and delta waves are usually called *spontaneous* brain potentials, because they emerge independently of the direct external stimuli. In other words, these waves emerge spontaneously and depend only on the momentary state of the subject, and not the environment, in which the subject is placed. Contrary to this, when the subject is placed in an active environment and reacts to it, different brain potentials emerge.

Investigations have revealed lots of various brain potentials, which emerge in specific conditions and have specific traits. A description of these potentials will be given first with a taxonomy [Božinovska et al, 1992], given on Figure 3.12.

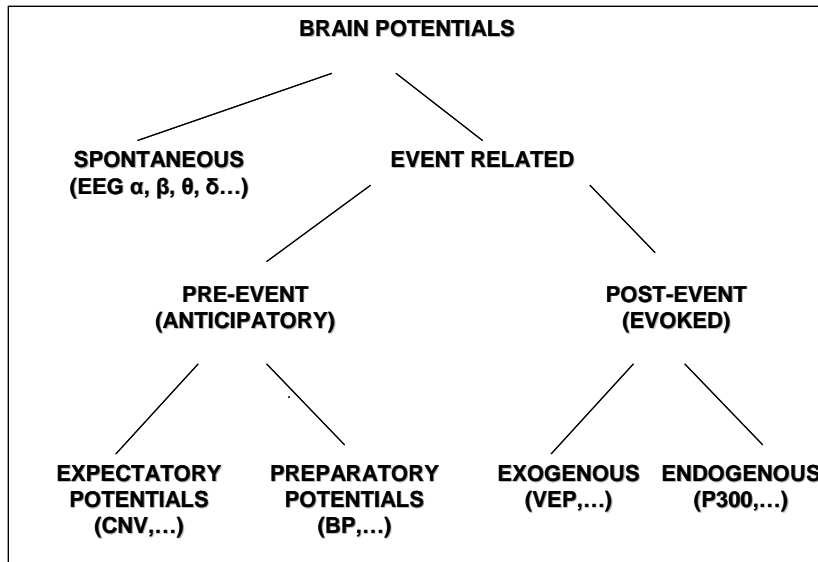

Figure 3.12. A taxonomy of brain potentials

According to this taxonomy, the brain potentials are divided into spontaneous (background EEG) and event related potentials (ERP). Event related potentials are divided into anticipatory (pre-event) and evoked (post-event). Anticipatory brain potentials are event related brain potentials that appear *before* the event, as opposite to classical evoked potentials that appear *after* the event. Post-event potentials can be divided into exogenous (reflexive) and endogenous (cognitive). An example of exogenous signals is the visual evoked potential (VEP). An example of endogenous potentials is the P300. Pre-event potentials are divided into *expectatory* (to an event) and *preparatory* (for the event). An example of an expectatory potential is the Contingent Negative variation (CNV) potential. An example of a preparatory potential is the Bereitschaftspotential (BP). Both expectatory and preparatory potentials were first reported in 1964, by Walter et al [1964] and by Kornhuber and Deecke [1964] respectively. Figure 3.13. gives the time scale of the event related potentials.

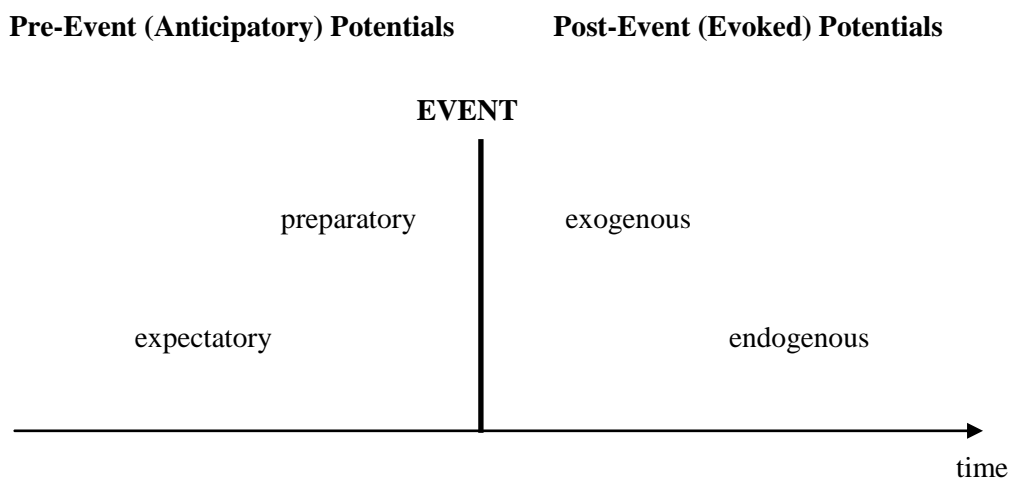

Figure 3.13. Time scale of the Event Related Potentials

As Figure 3.13 shows, the expectancy potentials appear first, then the preparatory potentials. Reflexive (exogenous) potentials appear immediately after the event and signal that the event was registered. Cognitive (endogenous) potentials appear later, signaling that the event was processed.

In summary, for *anticipatory brain potentials*, the preparatory potentials are initiated internally, by the *will of the subject*. Expectatory potentials are initiated by some *expected external event*.

### 3.6. Evoked Brain Potentials

Event related potentials appear as a reflex reaction of the brain to the event (or stimulus). Generally, every event or stimulus, which is registered by the brain, creates some sort of a brain potential. Different potentials appear as results of different stimuli. Since these potentials show just knowledge of an existence of a stimulus after it appeared, and not of its meaning, they are called *exogenous* potentials. Evoked potentials show the function of the sensor pathways from the excitation spots (receptors) to the primary cortical region of the examined sensory system. Contrary to them, *endogenous* potentials appear when the event or stimulus, that had just happened, is given meaning. Thus, these potentials don't depend on the type of the event or stimulus itself, but on whether that event or stimulus means something to the subject. A typical example of such potentials is the P300 potential, which peaks 300 milliseconds from the moment of occurrence of the event or stimulus, from where it got its name.

Evoked potentials (EPs) constitute an event-related activity which occurs as an electrical response from the brain or the brainstem to various types of sensory stimulation of nervous tissues; auditory and visual stimulation are commonly used. EPs provide useful information about sensory pathways abnormalities, localization of lesions affecting sensory pathways, as well as disorders related to language and speech. They are recorded from the scalp in a regular EEG form, but have transient waveforms, the morphology of which depends on the evoking stimulus and the electrode position on the scalp. The mental state of the subject such as attention, wakefulness, and expectation, also influence the waveform morphology. For an EP analysis of a subject, usually a normal waveform is assumed or given, and the obtained waveform is judged for normality.

Individual EPs have very low amplitude, ranging from 0.1 to 10  $\mu\text{V}$ , and are hidden in the ongoing EEG background activity, with amplitudes between 10 and 100  $\mu\text{V}$ . In EP investigation, the normal EEG is viewed as noise, the influence of which should be minimized. Therefore, the noise reduction issue is most frequently addressed in any work dealing with EPs. The approach used towards this issue is based on the assumption that an EP occurs at a certain time after the stimulus, while the background EEG is a random noise in regards to the stimulus. So, repetitive stimulation with *ensemble averaging* is the most often used technique. Using this

technique is often sufficient to produce an EP waveform, the individual components of which can be analyzed in terms of amplitude and latency.

The ensemble averaging technique is the most useful when the EP is not changing over time. In some cases, it is important to detect the time varying EPs. An example is a neurosurgical procedure in which a time varying EP is observed. Considerable effort has been done to find a technique that can track dynamic changes and in the same time provide noise reduction. The analysis of time varying EP changes is commonly referred to as single-trial analysis. One popular approach is to introduce certain prior information on the behavior of the EP morphology. The assumption is that each EP can be modeled as a set of orthogonal basis functions. The EP is represented as a weighted sum of those basic functions and the weights are fitted to the observed EP.

By convention, negative amplitudes of EPs are plotted as spreading upwards, so the obtained positive and negative amplitudes are numbered by the time latencies from the stimulus. For example, P300 is a signal that appears 300 ms after the stimulus, and N400 is a negative signal that appears 400 ms after the stimulus. In addition to the convention, if a number is less than 10, it shows the temporary order of a signal component, rather than the latency of a signal. For example N3 means the third component of a considered signal that has negative amplitude. Figure 3.14. shows this convention.

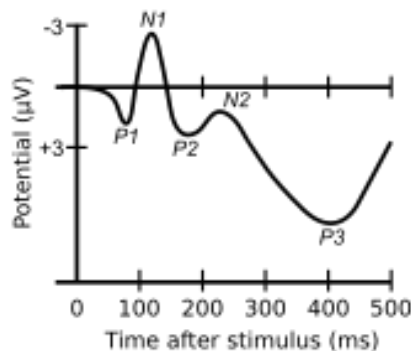

Figure 3.14. Example of an event related potentials containing components such as N100 and P300. Note that P300 in this case is at 400ms [5]

According to Sutton and Ruchin [1984], the following criteria are used to distinguish between components: latency, polarity, sequence, scalp distribution, relation to physical parameters of stimuli, relation to behavior, and relation to population and state of the organism variables. It is pointed out that latency varies for the same ERP and that sometimes negative components appear as positive due to a different choice of the baseline.

EPs are often analyzed from a single channel. However, a technique known as brain mapping is also used, in which isopotential lines are recorded by several electrodes and thus plotted. A distribution of a wave over the whole scalp can be observed by this technique. Figure 3.15. shows this technique. In Figure 3.15., hard lines show zero potential, thin lines show positive potentials, while dashed lines



negative potentials. The maps are usually computed for latencies at which the waveform either has a peak or a trough. The maps are used to discuss the bioelectric distribution in terms of dipoles [Picton et al. 1995]. Figure 3.16. shows a brain map using this approach.

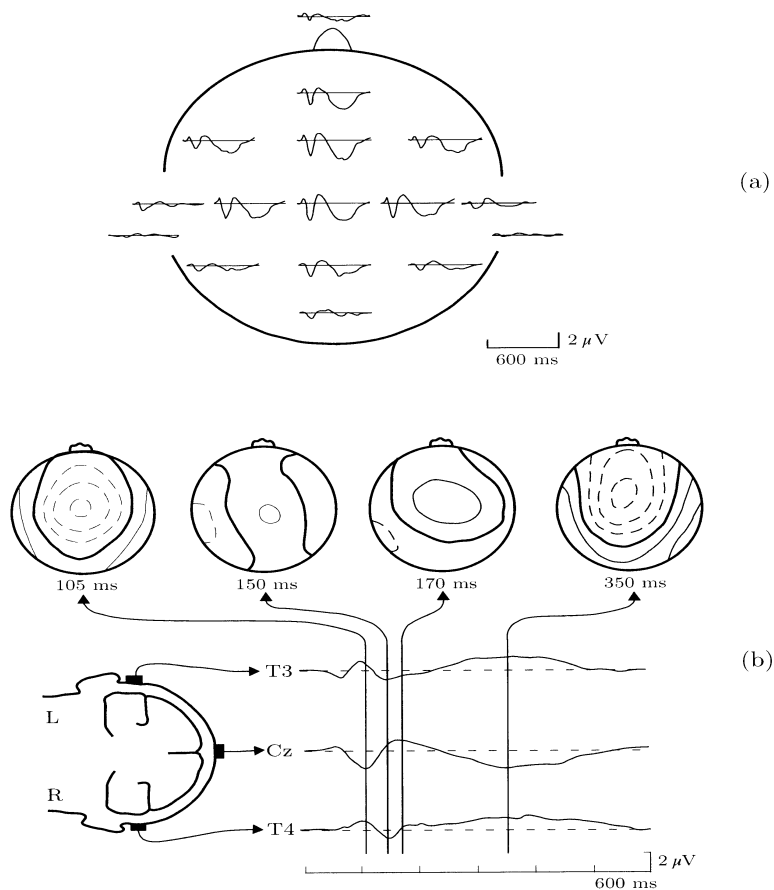

Figure 3.15. Brain map of an auditory evoked potential. a) recording places on the scalp and recorded waveforms. b) computed brain potential distribution.

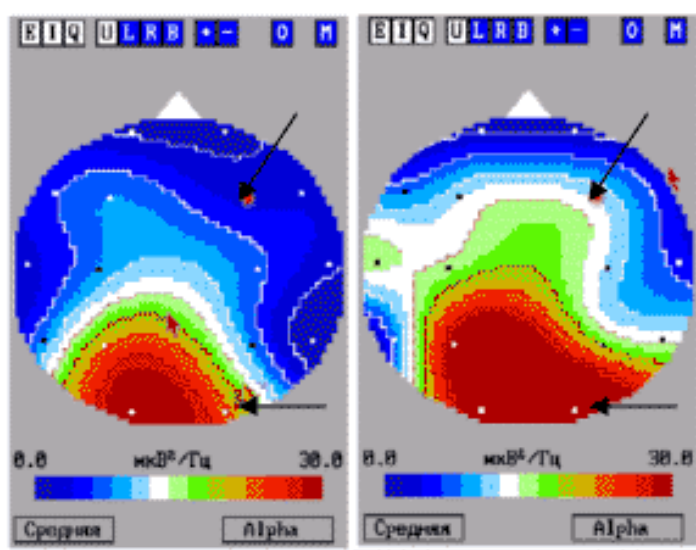

Figure 3.16. A brain mapping example [8]

### 3.7. Exogenous Evoked Potentials

Exogenous evoked potentials appear as a reflex of the brain to an external stimulus. For example, if an audio signal appears, the brain will produce a signature potential, which will show that the signal has been received. The response cannot be modulated by the will of the subject. Classical exogenous potentials are Auditory Evoked Potentials (AEP), visual evoked potentials (VEP) and somatosensory evoked potentials (SEP). Here those potentials will be briefly examined [Soernmo and Laguna, 2005].

#### 3.7.1. Auditory Evoked Potentials

Auditory EPs are generated in response to a sound stimulus, usually a short sound wave. This EP shows how information travels from an auditory nerve in the ear through the brainstem to the auditory cortex. So, the AEP usually has 3 phases: the brainstem phase, early middle cortical response and late cortical response. Brainstem auditory evoked potentials (BAEP) have been used to evaluate hearing loss (audiometry), diagnosis of certain brainstem disorders, and intraoperative monitoring to prevent neurological damage during surgery. Middle cortical response has been used to evaluate depth of anesthesia during surgery – it has been found that the depth of anesthesia is proportional to the latency of the middle cortical response.

*Recording setup.* A short sound wave is delivered through stereo headphones (Figure 3.17.). One ear is stimulated at a time, the other being masked by a bandlimited noise (“pink noise”). The click sound is produced by a 0.1 ms square wave pulse, with repetition rate of 8-10 times per second. The intensity is between 40 and 120 dB. Zero dB is equivalent to the pressure of 20  $\mu\text{Pa}$ . Electrodes are placed behind the left and right ear and at the vertex.

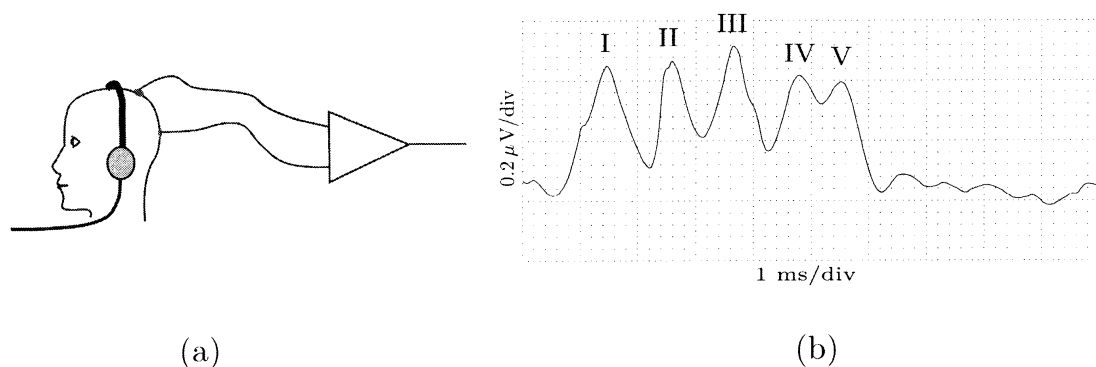

Figure 3.17.: Auditory brain potentials (AEP) : a) recording b) A brainstem AEP waveform

*Waveform characteristics.* An AEP has three parts: the brainstem AEP has very low amplitude, 0.1 to 0.5  $\mu\text{V}$ , and occurs 2 to 12 ms after the stimulus. The short duration implies that the frequency range of BAEP is between 500 Hz to 1500 Hz. In a normal subject it is an oscillatory waveform with up to seven peaks. By

convention, the peaks are labeled with Roman numerals. Both the loss of a peak and variability in duration provide important information for audiometry. A BAEP is stable in form, so ensemble averaging will reproduce its form. The middle AEP occurs after 12 to 50 ms after the stimulus. The late components follow the late AEP and are in the range of 1-20  $\mu\text{V}$ . The late components vary in duration so ensemble averaging would not reveal a constant pattern.

### 3.7.2. Somatosensory Evoked Potentials

Somatosensory evoked potentials (SEPs) are elicited by electrical stimulation from the body surface of a particular peripheral nerve, usually from an arm or a leg. Somato- means any place on the body. The SEPs are used for evaluation of the sensory pathways from a peripheral nerve through the spinal cord to the cortex. Certain neurological disorders such as multiple sclerosis can incur damages that can be observed by SEPs. SEPs are also monitored during a surgical procedure involving the spinal cord.

*Recording setup.* Stimulation is performed by delivering a brief electrical impulse via stimulus electrodes positioned close to the sensory nerve (Figure 3.18.). In clinical practice, the median nerve on the arm and tibial and peroneal nerves on the legs are used. Recording electrodes are placed to certain spots over the motor-sensory cortex. Additional electrodes are also placed along the conduction pathways, such as on the knee and the spinal cord.

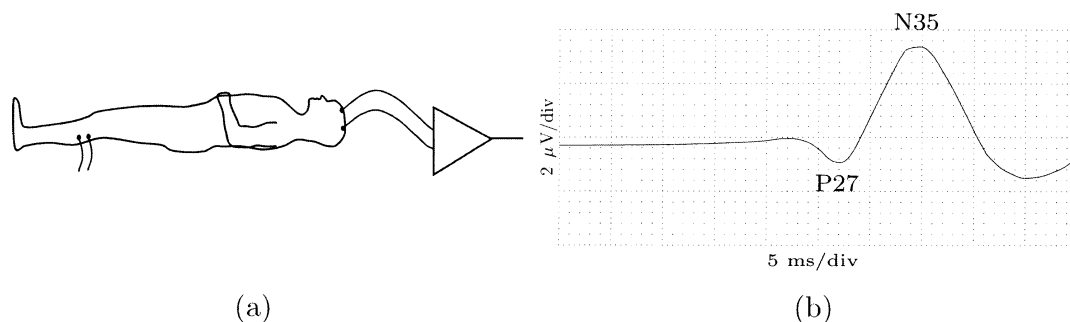

Figure 3.18. Somatosensory evoked potentials. a) setup b) typical waveform

*Waveform characteristics.* A SEP has spectral characteristics above 100 Hz. The total SEP duration is about 400 ms, however only the first 40 ms are recorded and analyzed. The rest of the long latency exhibits large variability.

### 3.7.3. Visual Evoked Potentials

Visual evoked potentials are used for evaluation of visual pathways from the eyes to the occipital region of the scalp. Two different stimuli are used: pattern reversal and flashing. Relevant information is observed at 75 ms after the stimulus, followed by a rather long latency response, lasting beyond 100 ms. VEPs are used for detection of ocular and retinal disorders, as well as optic nerve pathology and visual field defects.

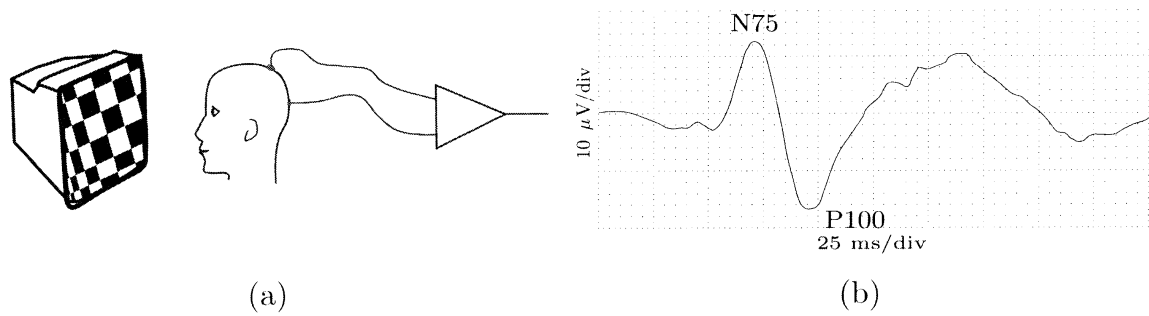

Figure 3.19. Visual evoked potentials. A) setup b) waveform characteristics

*Recording setup.* The stimulus is often a chessboard pattern being displayed on a video screen (Figure 3.19.). The subject fixes his/her sight on a point in the middle of the screen while the squares change the color from black to white and vice versa. The rate of change is fixed, usually two changes per second. The size of the chessboard, the luminance, the contrast, and the repetition rate are parameters of the investigation. The flashing stimulus is used when the subject cannot keep a focus at a point in the visual field, or even if the eyes are closed. The repetition rate of flashes is between five to seven flashes per second. The electrodes are positioned close to the visual cortex and the reference electrode is at the vertex.

*Waveform characteristics.* A VEP has a larger amplitude than a SEP or an AEP, ranging up to 20  $\mu\text{V}$ . A VEP can even be observed directly from the raw EEG. The spectral components of the VEP range from 1 to 300 Hz. The P100 peak can sometimes split in two waves and is usually interpreted as abnormality.

### 3.8. Endogenous Evoked Potentials

AEP, SEP, and VEP are obtained in a stimulus-response paradigm, where the stimulus comes from the outside world. Those EPs are referred to as “exogenous”. They are usually followed by cognitive waves, which are not related to the stimulus itself but to the cognitive reaction to the stimulus. Such EP components are denoted as “endogenous”. Latencies of endogenous EPs are 300ms and longer. Here, the P300 and N400 cognition related potentials will be mentioned.

#### 3.8.1. P300

P300 is an event-related potential that occurs upon recognition of a given stimulus in a series, as being unlike the previous stimuli, referred to as an oddball stimulus in literature. It is important in the study of attention, as it occurs when the attended part of reality changes, replacing boredom (or at least inhibited response) with interest in the new stimulus. For P300, it is known that if there are two stimuli in a sequence, the P300 is larger for the second stimulus. An interpretation of this has been given, that the P300 is larger in the region where critical information is extracted from a stimulus. The P3 component of an ERP is usually also related to the probability of appearance of the corresponding stimulus.

P300 is understood to mean that the subject is able to consciously identify and categorize a stimulus, and represents the subject updating his working memory with the new information. For instance, if a subject has been listening to trombone noises and a flute tone is played, a P300 wave will appear 300 ms later on the EEG recording. Amplitude of the measured P300 wave is inversely related to the probability of the oddball stimulus. This means that the less frequent the oddball is, the more visible the P300 spike will be. Interestingly, a small P300 will appear for both categories of stimuli when they are presented at nearly the same frequency, and will be slightly larger for the slightly less frequent category. For instance, when asked to press one button, if the presented letter is a vowel, and another if it's a consonant, there will be a P300 wave for both, and it will be higher for whichever letter type is less common. Thus, the P300 can be used to determine concealed knowledge, and this is utilized when testing for information that only a criminal would know, to solve a crime, for example. By placing details of the crime(s) randomly among a list of non-relevant items, one can distinguish the criminal from any ordinary citizen. If an individual recognizes a detail of the crime, he/she produces both a P300 event-related potential and is at least familiar with the crime.

P300 waves are present in people with most varieties of mental retardation, suggesting that their working memory is being updated in the same way as everybody else's. Psychotropic drugs, however, do have an effect on P300.

### 3.8.2. N400

It has also been noted that N400 is related to ease with which information is accessed from the memory. However, N400 is mostly related to processing semantic information. If in a sentence an “oddword” appears, additional processing is needed and this is reflected in the N400 amplitude. Words expected in context elicit smaller N400 responses. Figure 3.20. shows a cognitive task where N400 is elicited.

‘They wanted to make the hotel look like a tropical resort.  
So along the driveway they planted rows of ....’

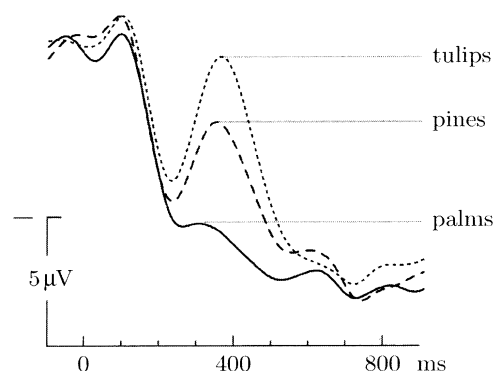

Figure 3.20. The sentence above was shown with three different endings. It seems a kind of tree was expected as a word. A flower category word elicited higher N400 [Soernmo and Laguna 2005]

### **3.9. Event Related Potentials and Cognitive Science**

Event related potentials are a manifestation of the processes in the brain related to some events. Various psychological constructs were assigned to event related potentials and their components. Event related potentials might be used to answer questions about phenomena in cognitive science and related fields, such as affective neuroscience, and psychopathology [Luck, 2005].

The intent is to interpret the event related potentials and their components to cognitive and behavioral functions. For example, N1 is usually a potential generated due to external stimuli as a reflexive brain process. P2 is usually related to signal recognition and N2 to a decision what to do. However, the S2 (the imperative stimulus) related potentials contain trained components and the reaction to S2 comes faster than N2.

Other terms are often used to describe an ERP function and its relation to behavior. If a potential is endogenous and is generated without a significant external event, then it is called a command potential [Gilden et al, 1966] or an emitted potential [Sutton et al, 1967]. It is possible that the readiness potential (BP) [Kornhuber and Deecke, 1964] is such a type of potential.

P300 has been related to the construct of confidence level by which recognition of the corresponding events is decided upon. For example, Kerkhof [1982] has reported that P300 (referred by him as P450) is larger when the confidence is high and smaller when the confidence is low. With increased confidence, the latency of P300 decreases. It has been noted that evoked potentials always have a positive slow wave component. This has been considered a separate evoked potential, named Slow Wave (SW), which is a positive potential. However, related to confidence level, opposite relation is found to the one in P300.

The principal psychological concept used today for endogenous components is the concept of cognition introduced in ERP research by Donchin [Donchin, 1984] Stimulus salience, stimulus uncertainty, and surprise are also used. The concept of value in ERP research was introduced by Sutton and Ruchin [1984]. They suggest that rather than concentration on surprise (high uncertainty) and surprise reduction, a value of that information should be considered.

### **3.10. Event Related Potentials and Brain Functioning**

The study of event related potentials at some point of time became a field of its own. However, there was a time that going a direction towards “ERPology” did not address the real challenges, such as how the brain functions. So a model was needed to which event related potentials could relate. Several models have been used, one of them being the Luria model. Figure 3.21. shows the Luria model and the information flow within the brain.

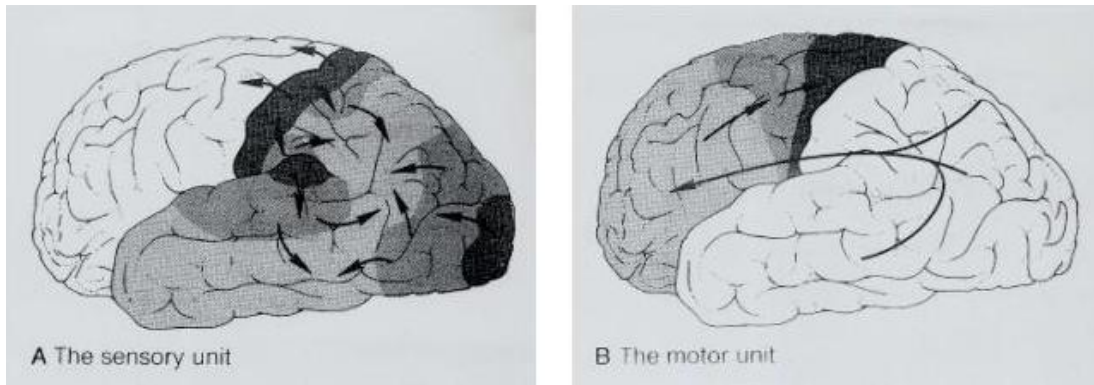

*Figure 3.21. The Luria model of brain functioning [6]*

According to this model, the information from the outside world is collected in the posterior, sensory portion of the cortex, from where it is sent to the anterior, motor portion of the cortex. Both cortices are divided into zones: primary, secondary and tertiary.

Information enters the sensory cortex through the primary zone. Here, primary sensory data are gathered. In the secondary zone, these data are elaborated, i.e. their meaning is established. In the tertiary zone, the “big picture” is understood, i.e. the significance of the information obtained in the secondary zone. This information would then be transferred to the tertiary zone of the motor cortex, where intentions are formed, to act upon the gathered information. Then, in the secondary zone, concrete plans of action are formed, to fulfill those intentions. Finally, in the primary zone, those steps in the plan are acted upon and executed. The limbic system (hippocampus and amygdala) are also involved [Kolb and Wishaw, 1996].

## **Chapter 4**

# **ANTICIPATORY BRAIN POTENTIALS**

This chapter focuses on the anticipatory brain potentials. As an example of preparatory potentials, the Bereitschaftspotential (BP) is presented, and, as an example of expectancy potentials, the contingent negative variation potential (CNV) is presented. Focus is given to the CNV, and its morphology and original paradigm to obtain it are presented. Finally, the relation of this potential to other cognitive processes is shown.



## 4. ANTICIPATORY BRAIN POTENTIALS

The difference between the anticipatory and evoked potentials is that the anticipatory potentials appear *before* the event, whereas the evoked appear *after* it. So, the anticipatory potentials show readiness of the brain for the given event, where the evoked show its reaction to that event. The anticipatory brain potentials are a distinct manifestation of the brain's electric field, related to an event, but appearing before the event, thus manifesting some anticipatory and preparatory process in the brain for that event.

These potentials are in the group of endogenous potentials. They, along with the other late components of post stimulus ERPs, are called **cognitive event related potentials**. They appear in paradigms, in which there is a certain mental or motor task, which the subject needs to do (or solve). They are relatively independent of the physical parameters of sensory stimulations. A given stimulus may or may not wake up an endogenous component, which depends on the cognitive context of the given stimulus. These components reflect variables such as: task complexity, importance of the stimulus for the subject or the focus of attention of the subject.

There are two groups of anticipatory potentials: **expectatory** and **preparatory**.

Anticipatory (or pre-event) potentials appear immediately before the event or some time before it. In both cases, the subject must know that the event will happen. In case that the knowledge is about an event that will happen in the further future the potentials that emerge are *expectatory potentials*. These potentials show a general state of preparation of the subject and mark his/her knowledge about the event and an expectation of it. A typical example is the CNV potential, which will be given more attention later.

*Preparatory potentials* are also anticipatory. They emerge when the subject is ready to react to an event or to produce the event. A typical example of these

potentials is the Bereitschaftspotential (BP), which appears immediately before every motor action of the subject. This potential shows the existence, so to speak, of a willful command of the brain to act or react to the event.

#### 4.1. Preparatory Potentials. The Bereitschaftspotential

The most prominent and well-studied potential from this group is the Bereitschaftspotential (or BP), and it will be presented here in more detail.

BP has been discovered in 1964 by Hans Helmut Kornhuber (at the time assistant professor and chief medical doctor at the neurophysiology hospital in Freiburg im Breisgau) and Lüder Deecke (who was doing his doctoral dissertation at him). At the spring of 1964 both were aware and unsatisfied by the opinions of the scientific public at the time, that the human brain is a passive system, which only reacts to external stimuli. They wanted to research the behavior of the brain in cases when it performs willfully initiated actions. They were not the only ones with such intentions, but at the time they didn't have conditions for such research.

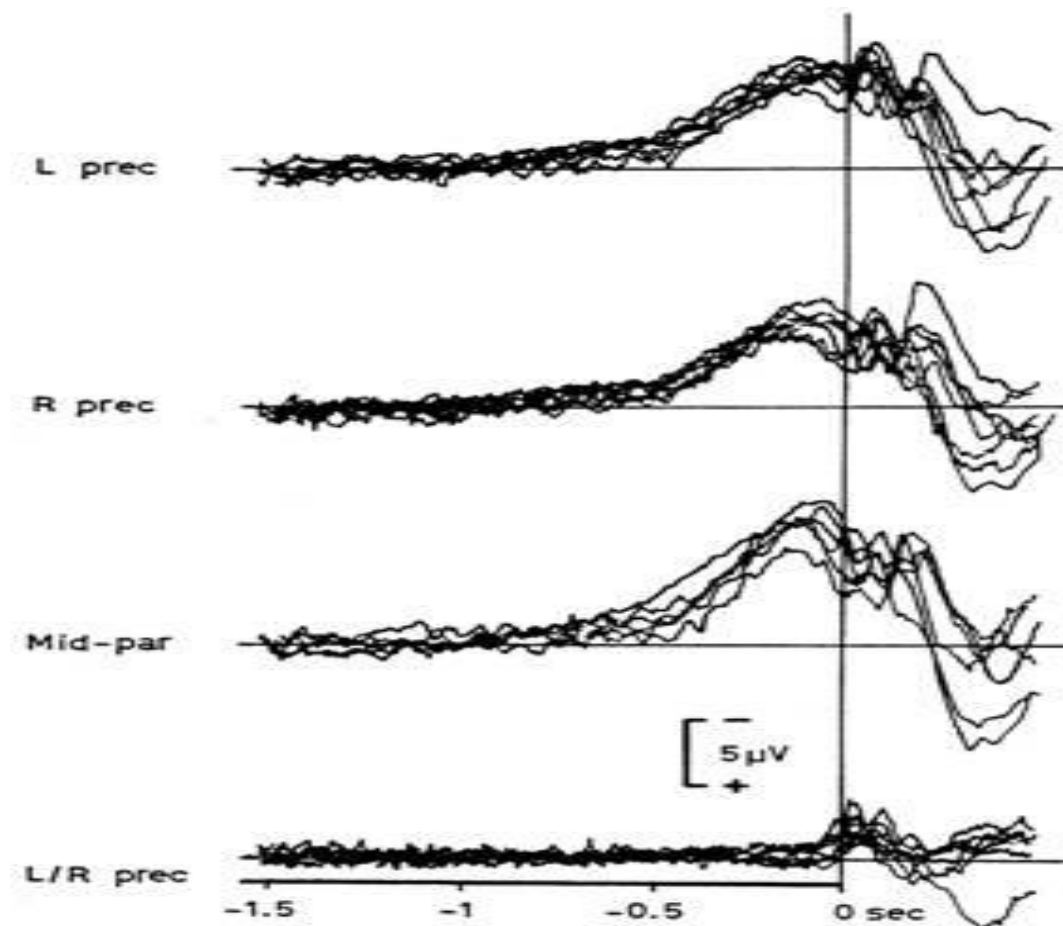

Figure 4.1. A typical Bereitschaftspotential recording [7]

The situation improved when an averaging computer arrived in the laboratory in Freiburg. When Kornhuber and Deecke compared the EEG and EMG

(*ElectroMyoGram* – a recording of the electrical potentials from the motor muscles) in willful motor movements (finger flexion), they couldn't notice changes in the EEG before the movement. But, when they analyzed the average EEG during the trials, they noticed an appearance of a potential, which appeared immediately before the action. That same year they published the finding [Kornhuber and Deecke, 1964], and the next year, after detailed research and control experiments in passive movement, a paper has been published [Kornhuber and Deecke, 1965] which introduced the term *Bereitschaftspotential*.

The *Bereitschaftspotential* is 10 to 100 times smaller than the EEG alpha rhythm and can be noticed only after averaging. Figure 4.1. shows a typical BP recording during hand finger flexion, where the vertical axis, i.e.  $t = 0$  seconds, is the moment of flexion. The recording has been done on three regions of the skull, namely left precentral (C3), right precentral (C4) and mid-parietal (Pz), whereas the reference potential was on the ears. Also, difference between the BP on positions C3 and C4 is shown. Results on the figure are from the same subject during 8 days.

It's interesting that this potential appears before *all* conscious and voluntary muscle movements, regardless of whether it's a movement of a finger, the eyes, the lips or even the throat during swallowing [Huckabee et al, 2003]. Therefore, the BP represents a command from the brain for *voluntary* muscle movement. At the time of its discovery, the voluntary muscle movements were connected to a person's free will, which was contrary to the opinion of the public that freedom is just an illusion; Freud's psychology, which was dominant at the time, claimed that a person's actions are predetermined and depend solely upon external circumstances, and not the person's will. At the time of discovery of the BP, things have gone so far, that the free will of a person was not even discussed, so words like "will" and "volition" were erased from the dictionary of the American Physiological Society [Heckhausen, 1987]. The BP showed that the supplementary motor area of the brain takes part in movement realization and activates before it, i.e. before the primary motor regions [Deecke and Kornhuber, 1978]. The discovery of BP has reignited the discussion around free will [Deecke and Kornhuber, 2003], which is still ongoing.

## **4.2. Expectatory Potentials. The Contingent Negative Variation**

The expectatory potentials imply that there is a prior knowledge that an event is going to happen, and they show expectation to that event. A typical expectatory potential is the contingent negative variation (CNV) potential, which will be described here.

As a term, CNV describes the slow shift of the brain signal, which develops during a warning period, and before a certain event, such as motor or mental activity. The shift toward the negative begins around 400 milliseconds after a warning stimulus (S1) and usually ends with the appearance of an imperative stimulus (S2), i.e. a stimulus that requests a response from the subject.

Curiously, both the CNV and the Bereitschaftspotential findings were published in 1964. The first paper about the CNV appeared in the Nature magazine, and was published by a group led by W. Grey Walter [Walter et al, 1964]. Interestingly, before his work on brain potentials, Walter worked on robot building. He built the first mobile robot, able to follow light by the heliotropism principle. In the brain potential research area, though, he introduced the expectancy potentials through the CNV.

The CNV potential appears in an experimental procedure called the *CNV paradigm*. Basically, it is a reaction time measurement procedure, in which at the same time the EEG is recorded. In the reaction time measurement procedure there is signal S1, which directs the attention, and signal S2, that is to be reacted on. The distance between the signals is about 2 seconds. Walter and his coworkers have noticed that after several appearances of the S1-S2 pair, a negative shift in the EEG emerges between S1 and S2. Using the averaging technique, they showed that this is a separate potential, which connects S1 and S2 and is thus of a cognitive type. The group suggested that this is a potential of expectation of S2 after the appearance of S1. The potential isn't reflexive event-related, but contains a cognitive component of expectation, and possibly preparation for S2. Figure 4.2. shows the originally published result.

### 4.3. CNV Morphology

Figure 4.3. shows a typical CNV potential. It is actually a complex potential, composed of several components or several evoked potentials, which appear in this period: an exogenous evoked potential, which appears because of the appearance of S1; the N100 peak, which is the reaction of expectancy to S1; P300 – the storage of S1 in the short-term memory and its comparison to the existing patterns. After P300, the rise of the negative potential shift starts, about 400 milliseconds after S1, which lasts until the appearance of the preparatory potential to S2. Immediately after S2 there is usually a drastic shift towards positivity, so-called postimperative positivity, i.e. a decrease of negativity of the CNV potential immediately after the motor response to S2. This is normal in healthy subjects in simple experimental conditions of the CNV paradigm.

Observing the CNV potential morphology, it can be seen that it is a rather complex signal. After the stimulus S1, reflexive evoked potentials appear related to S1. The cognitive P300 potential can also be recognized. Somewhere after P300, a negative ramp is taking shape, manifesting the expectation to S2. It is the most important part of the morphology and represents a complex cognitive process of *learning to expect S2 after S1 in order to achieve a goal – minimum RT on S2*. After S2, reflexive and cognitive evoked potentials are present. In some cases a prolonged plateau is present after S2.

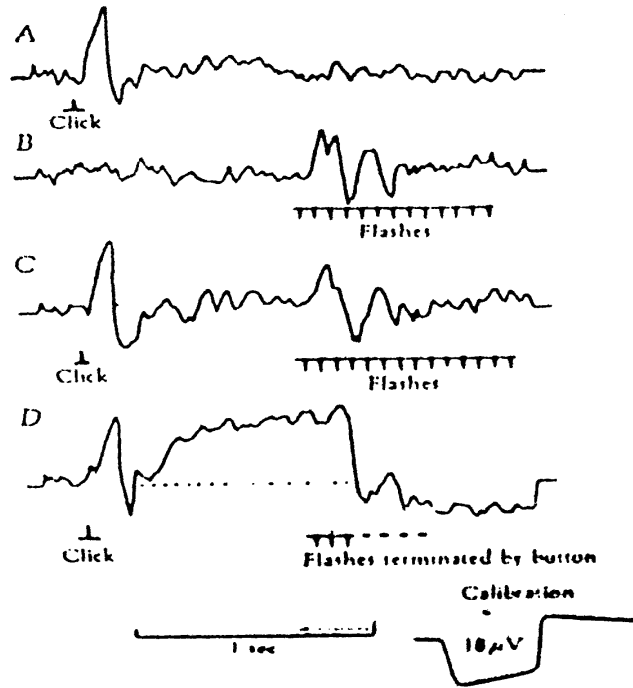

Figure 4.2. The CNV potential. If the subject is administered the auditory stimulus S1, he/she responds with an auditory evoked potential. If only a light stimulus S2 is shown, he/she responds with a light-caused evoked potential. If S1 – S2 is repeated many times, within the interval S1 – S2 an expectancy potential appears, because S1 has already appeared and the subject expects the appearance of S2 [Walter et al, 1964].

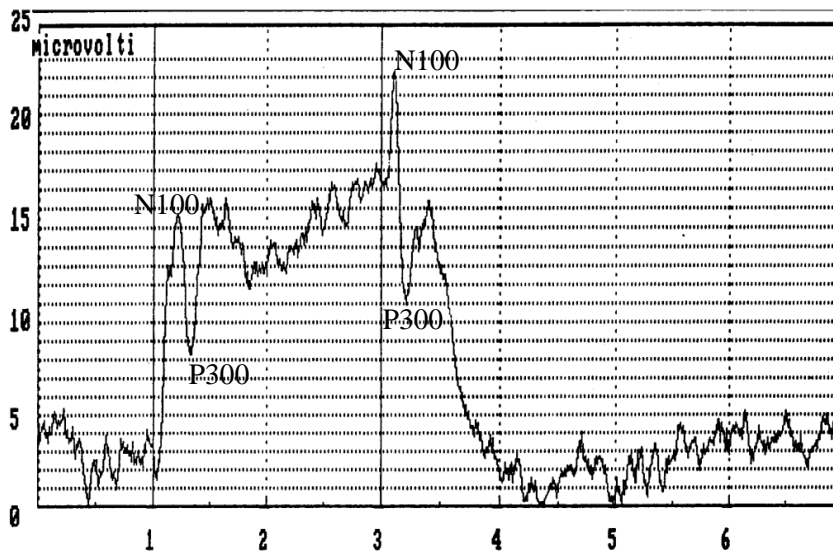

Figure 4.3. Morphology of a CNV potential [Bozinovska et al 1992]

The CNV morphology varies across subjects. The CNV potential has been extensively studied in relation to various populations of both healthy and unhealthy subjects. Its morphology can be (and in some cases is) used as a diagnostic tool, to

determine the presence or absence of certain neurological diseases. Different parameters of the wave, such as slope (measured in microvolts per second), peak-to-peak amplitude, total energy, topography etc, vary from subject to subject and depend on the experimental procedures. These parameters vary and depend also on the physical state of the subject (anxiety, depression, schizophrenia etc.)

There is still the question about the CNV potential morphology: is it a brain wave, which has many relations to a large number of experimental variables, or is it a combination of many waves, of which each has simple relations with a limited number of variables. The CNV potential is considered complex, composed of two groups: early and late (terminal) CNV. The early CNV, also called the orientation wave, has a frontal origin and is actually a late component of the event potential, caused by the warning S1 stimulus. Therefore, there is an influence of the meaning of the task to the degree of early negativity. On the other hand, the late CNV has its peak above the central region, where a motor response is necessary. It is considered that it displays the preparation for a motor response of S2. It must be noted that other sources of expectation to S2 exist as well, such as the working memory activity and the mental work invested in the task.

In the CNV example shown in Figure 4.3., above the P2 is actually P300, which means that P300 is the second positive component in a CNV complex. Also, in Figure 4.3. it can be seen that if the baseline is defined at the level of the mean of the potential before S1, a positive post-S2 complex will be obtained below the baseline; such a component is known as a late positive complex.

It is not easy to distinguish the components and to give interpretation of a particular component, because the components usually overlap in time and space. The principal component analysis has been proposed [Donchin, 1966] as a mathematical method for distinguishing various ERP components. Scalp distribution is often used as a discriminating factor between components. It is known for example that the CNV is higher at Cz than at Pz. However, studies show that is also not always possible to discriminate components using scalp distribution criterion.

By convention, the components of an ERP are denoted regardless of the physical characteristic of the stimulus. For example, the N1 component of the CNV is named N1, regardless of whether the stimulus is auditory or visual. It is now accepted that the CNV has at least three negative components, possibly four [Rohrbaugh and Gaillard, 1983].

An interesting ERP in relation to the CNV is the O wave. It appears in a paradigm where one stimulus is present but in two modalities, for example a 2000 Hz tone and a 1000 Hz tone. The 2000 Hz tone appears in 75% of trials and 1000Hz tone in 25% trials. The subject should count number of appearances of the 1000Hz tone. The O wave morphology is shown in Figure 4.4.

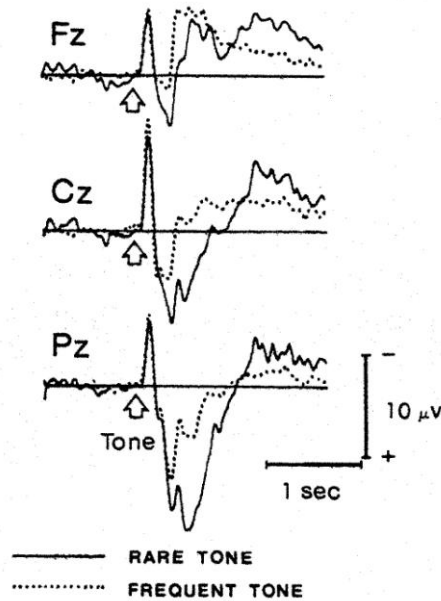

Figure 4.4. The O wave measured at Fz, Cz, and Pz [Ritter et al, 1984]

#### 4.4. The CNV Paradigm

Originally [Walter et al, 1964], the CNV potential has been obtained through the CNV paradigm, where, *in an open loop way*, a slow negative potential (the CNV) appeared in the inter-stimulus interval of the S1-S2 stimulus pair. The CNV paradigm is actually an extended reaction time paradigm. In a standard reaction time paradigm, two stimuli are presented: S1 (warning stimulus) and S2 (reacting stimulus). The subject tends to press a button as fast as possible after S2. A subject's reaction time (RT) is measured. To this paradigm the CNV paradigm adds measuring the EEG between S1 and S2. In fact, recording of the EEG starts before S1 and ends after S2. After several repetitions and after averaging over several trials of EEG segments, a specific shape forms between S1 and S2, which is the CNV potential. Figure 4.5. shows the experiment setup.

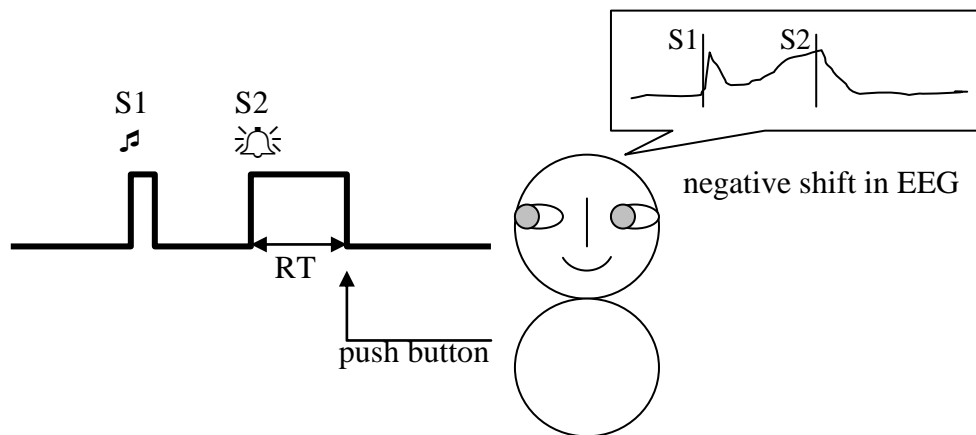

Figure 4.5. The experimental setup for the CNV paradigm

The procedure lasts for several trials. Figure 4.6. introduces the concepts of inter-stimulus interval (ISI) and inter-trial interval (ITI) used in the CNV paradigm.

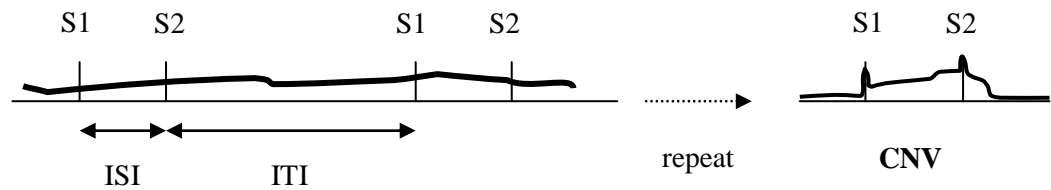

Figure 4.6. The CNV paradigm: inter-stimulus and inter-trial interval

Since its introduction, many modifications of the CNV paradigm have been proposed, and, according to the modification proposed in this work, a 2 second fixed inter-stimulus (ISI) interval is chosen, and a random 7-13 seconds inter-trial (ITI) interval. Both ISI and ITI can be chosen to be longer or shorter, if desired.

#### 4.5. The CNV potential and cognitive processes

The activity of the CNV potential has been suggested as an index for many processes (awakeness, expectancy, attention focus, preparation for activity or decision making) , which influence the forthcoming choice of response or cognitive processes that are connected with the imperative stimulus [Donchin and Johnson, 1982].

The focus of this research is the activity of the CNV potential, as an objectively measurable parameter of the degree of expectation, which itself is a cognitive process, which takes place in the CNV paradigm. Therefore, the next chapter elaborates it in more detail.



## **Chapter 5**

### **THE CNV FLIP-FLOP PARADIGM**

This chapter describes the CNV flip-flop paradigm. Its flow chart is presented, along with the central issues it faces as a paradigm, which must be worked out. Also, the Electroexpectogram (EXG), as a cognitive curve resulting from this paradigm, is presented.

## 5. THE CNV FLIP-FLOP PARADIGM

The discovery of the CNV potential and the CNV paradigm [Walter et al, 1964] has sparked scientific interest, and they have both been extensively studied [Teccce and Cattanach, 1993]. The original paradigm proposed by Walter et al is sometimes referred to as “The Classical CNV Paradigm”. Figure 5.1. shows the flowchart of the paradigm.

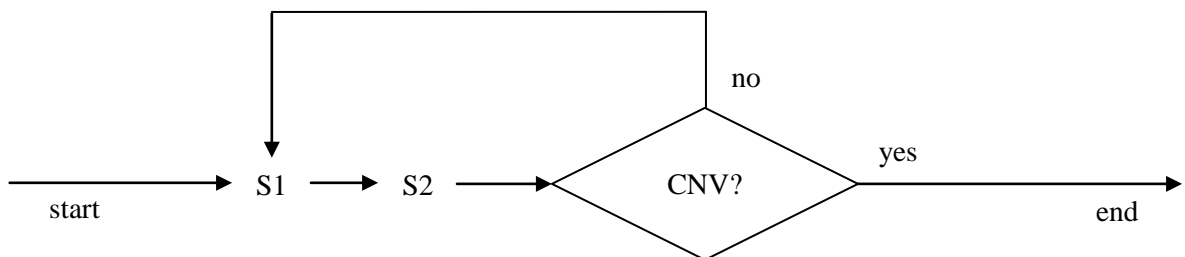

Figure 5.1. The original (“classical”) CNV paradigm

Several authors proposed various modifications of the classical CNV paradigm. Here the work of Božinovska, Išgum and Barac [1985] will be mentioned, who worked with random change of appearance of signal S2 in the paradigm. Figure 5.2. shows their modification.

Figure 5.3. shows the result of their work. Here  $p(S2/S1)$  gives conditional probability of appearance of S2 given S1. The shape of the CNV potential is shown, in case of appearance probability of  $P_1 = p(S2/S1) = 1$  and  $P_{0,5} = p(S2/S1)=0,5$ . Figure 5.3. shows that the CNV forms its shape very clearly if  $p(S2/S1) = 1$ , while in case that  $p(S2/S1) = 0,5$ , only the evoked potential appears due to S1, while the expectancy potential on S2 does not form.

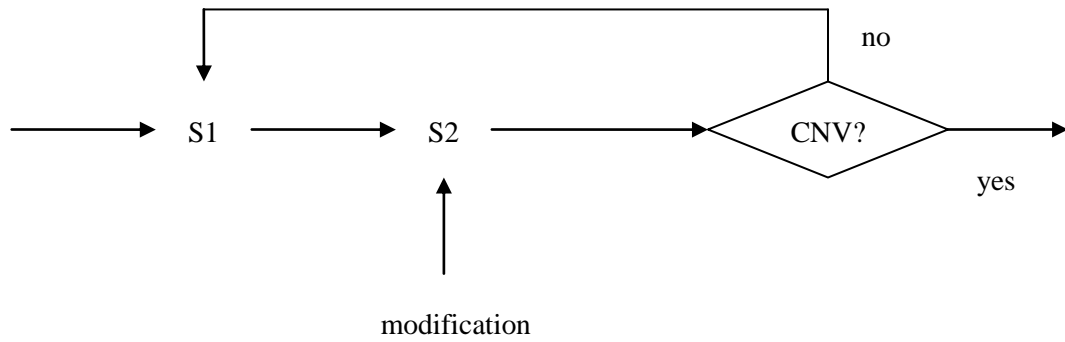

Figure 5.2. S2 appearance change in the CNV paradigm



Figure 5.3. Modification of the CNV appearance due to modulation of S2 [Bozinovska et al 1985]

Here another modification of the paradigm is introduced, which is called the *CNV Flip-Flop Paradigm*. The main feature is that it is a closed-loop procedure, by feeding the produced event-related potential back to the paradigm, and making it have an influence on the paradigm realization. Figure 5.4. shows the closed-loop design of the paradigm.

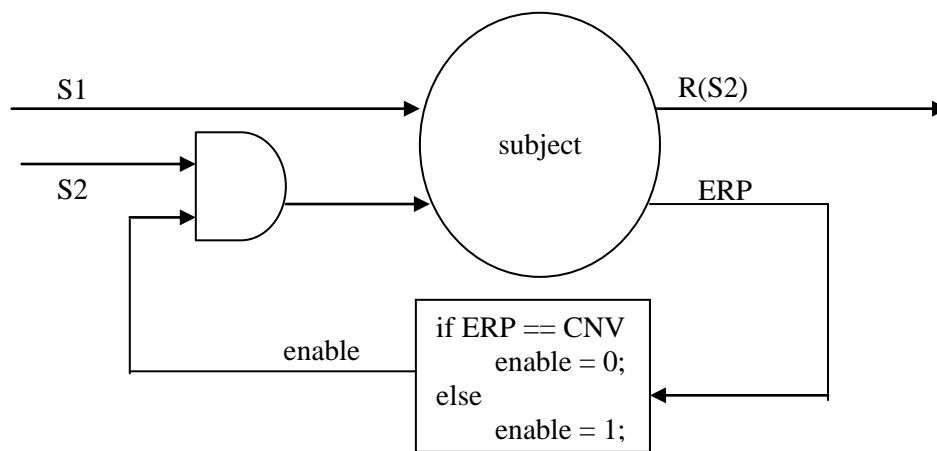

Figure 5.4. The closed loop CNV paradigm

As Figure 5.4. shows, S1 and S2 are inputs to the subject and R(S2), the reaction to S2, is the output. Here, instead of the p(S2/S1) condition, the p(S2/CNV) condition is introduced. The ERP is computer monitored and when the ERP becomes a CNV, S2 is blocked by a feedback loop. The subject continues to receive only S1. Because there is no R2, and consequently there is no R(S2), the CNV degrades beyond recognition. Then the computer activates S2 again through a feedback pathway. The CNV appears again and so on, until some end-condition stops the procedure. The end-condition might be a pre-specified number of trials, or a manual interruption of the procedure by the experimenter. This paradigm causes the expectancy state in the brain to oscillate. Figure 5.5. shows the paradigm's flow chart, which resembles a flip-flop device, and this is why the paradigm is so named.

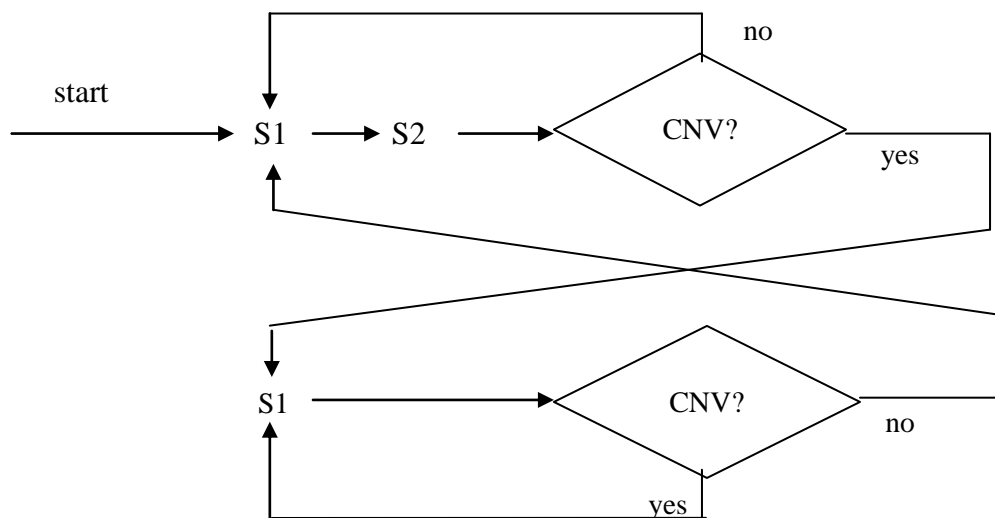

Figure 5.5. The CNV flip-flop paradigm

Figure 5.6. shows a more elaborated version of the CNV flip-flop paradigm flow chart. It shows the handling of the end-condition (running out of available trials) of the paradigm. If an experimenter is present, he/she is also able to manually interrupt the paradigm at any time.

The CNV flip-flop paradigm is a continuation of a previous work on introducing biofeedback in a CNV paradigm [Bozinovska et al 1988].

### 5.1. Central Issues in the CNV Flip-Flop Paradigm

A common method of extracting an event-related potential (ERP) is ensemble averaging. The ERP is assumed to be constant, so when the event is administered several times in a row, the obtained signal is averaged over trials, and thus the ERP would remain as a constant in the signal, while the background noise would get canceled out. This technique is especially effective for evoked potentials processing, since their EEG appearances are relatively stable in form.

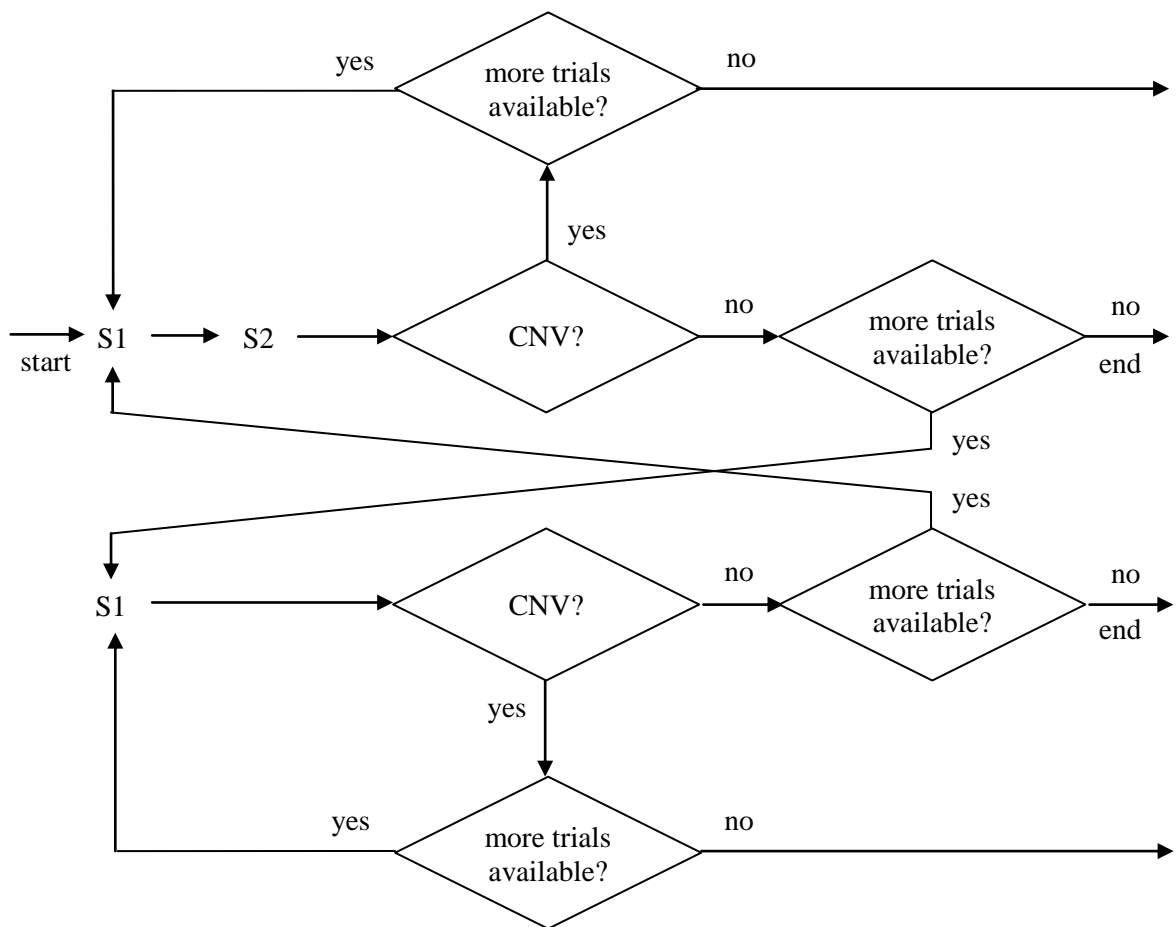

Figure 5.6. Handling of the end-condition in a CNV flip-flop paradigm

However, the nature of the CNV flip-flop paradigm is such, that the signal would at one time be considered a CNV, and at other time not. Thus, the signal is certain to change its form over trials and at one trial to be recognizable as a CNV, and at another trial not. As an illustration, Figures 5.7. and 5.8. show the signal in trials where it can and cannot be recognized as a CNV, respectively. Figure 5.7. is actually the same as Figure 4.3., but is repeated here for clarity.

To be able to recognize the appearance and disappearance of the CNV potential over time, one or more parameters of the signal need to be tracked. When one or more of those parameters surpass some threshold value, the signal can be considered a CNV and when it drops below the threshold, it is no longer considered a CNV. This is the method that is used in this work.

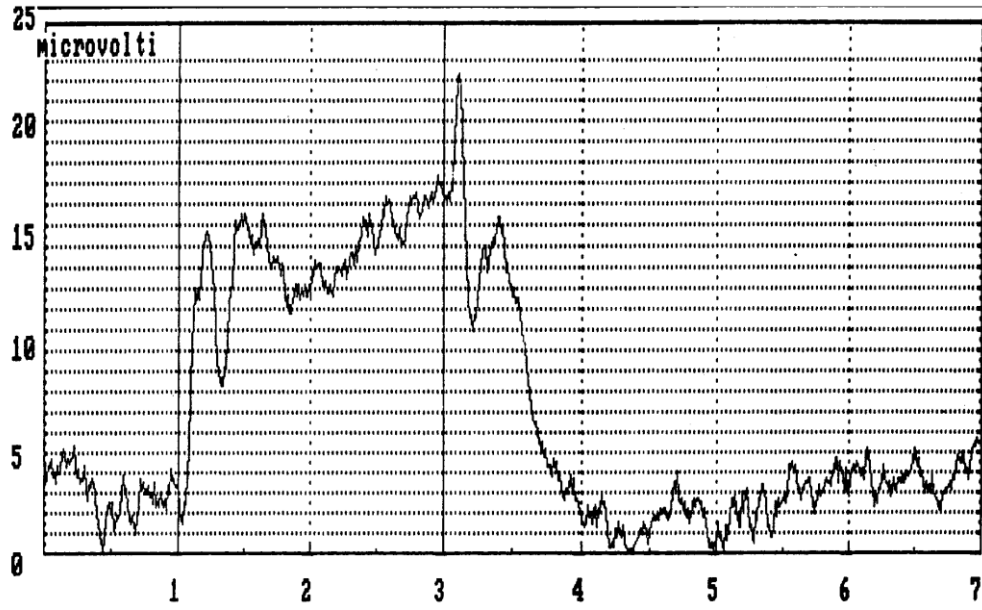

Figure 5.7. The ERP, when it can be recognized as a CNV [Bozinovska et al, 1992]

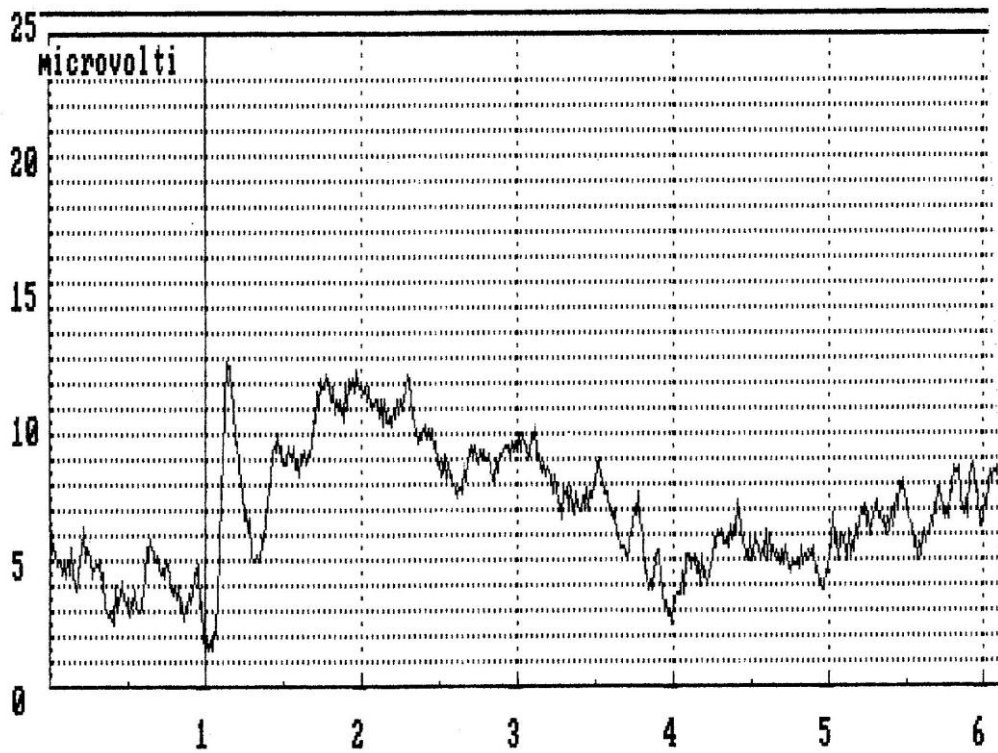

Figure 5.8. The ERP, when it cannot be recognized as a CNV [Bozinovska et al, 1992]

## 5.2. Electroexpectogram

The most commonly used parameter is the amplitude difference of the signal near S2 and the “baseline” of the signal, i.e. before S1. Another parameter of interest is the slope of linear regression of the signal between after the P300 segment following the appearance of S1, and at S2. Comparing one or both of these parameters against respective threshold values over trials can lead to successive recognitions of CNV appearances and disappearances.

Plotting the values of these parameters over trials results in a curve called the *electroexpectogram (EXG)*. The EXG can be constructed for any parameter of interest during the trials, and can be used to track the CNV oscillations over the course of the experiment. Figure 5.9. shows an EXG, constructed from the amplitude difference of the signal over trials, as well as the presence/absence of the S2 stimulus.

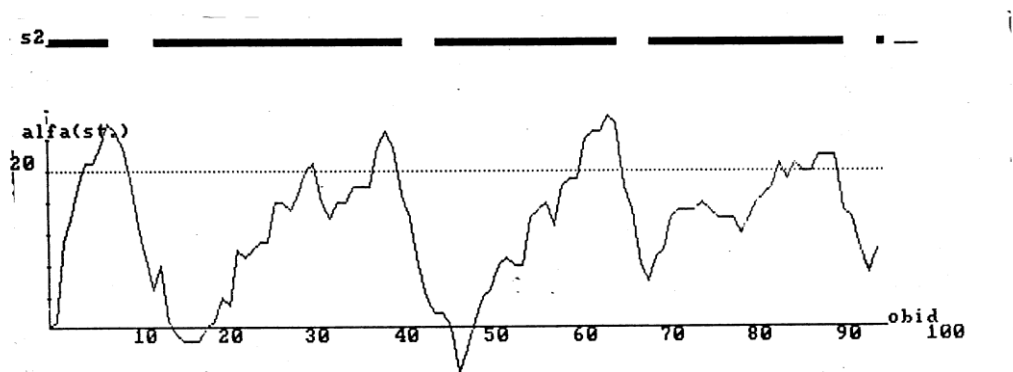

Figure 5.9. An EXG, constructed out of amplitude difference and S2 presence

The EXG is actually a cognitive wave, which represents expectancy and a learning process in the human brain. It shows the subject's ability to adapt to the environment changes and to maintain a certain level of expectation and attention over a relatively long period of time. In other words, the EXG shows how fast the subject adapts to the changing environment, i.e. how fast he/she learns to expect and not to expect.

Since the EXG is obtained as a result of an experiment involving a subject, it is case-specific and subject-specific and therefore it is safe to assume that no two subjects can produce the same EXG. Thus, as a tool, the EXG it can be (and indeed is) used for diagnostic purposes, to explore the cognitive abilities of the brain for adaptive expectancy.

In this work, in the subsequent chapters, it will be shown how the CNV flip-flop paradigm and the EXG can be used for control purposes as well. Also, given that the signal varies drastically during the course of the experiment trials, a method for extracting time-varying ERPs needs to be used. The method that is used is actually a neural learning method and is explained in more detail in the next chapter.

## **Chapter 6**

# **BCI ALGORITHMS APPLIED IN THE CNV FLIP-FLOP PARADIGM**

This chapter shows all the algorithms that the CNV flip-flop paradigms uses. They are for signal pre-processing, ERP extraction, and CNV recognition. The algorithm for CNV recognition is presented as a neural element, and the entire CNV recognition and calculation procedure is then presented in a form of a neural network.



## **6. BCI ALGORITHMS APPLIED IN THE CNV FLIP-FLOP PARADIGM**

The setup that is used in this work contains all the basic elements of a BCI (shown on Figure 2.1.), with the addition of the experimenter. The experimenter starts the paradigm, monitors its course and is able to reject certain trials, as well as stop it altogether. Figure 6.1. shows the experimental setup used.

The total paradigm time is organized in trials and intertrials, the brain signals from the subject being acquired during the trial periods. The trials last for 7 seconds fixed, where the first stimulus (S1) is administered at second 1, and the second stimulus (S2) is administered at second 3 of the trial. The remaining 4 seconds are used for acquisition of the post-stimulus potentials. Figure 6.2. shows the time organization of the paradigm.

The following sections explain the algorithms used in the BCI paradigm used in this work in more detail.

### **6.1. Algorithms for Signal Pre-Processing**

Initially, after acquisition, the signal from the brain is filtered, using a standard low-pass filter, with a 15 Hz cutoff frequency. This is sufficient to eliminate most of the artefacts, as well as the power network noise of 50 Hz. Additionally, the DC component (i.e. the frequency of 0 Hz) of the signal is also filtered out, so as to center the signal around the baseline. If acquired, the EOG signal is also filtered like this, whereas the EMG signal is not filtered (since muscle contractions require that the system be submissive to high frequencies in order to detect them).

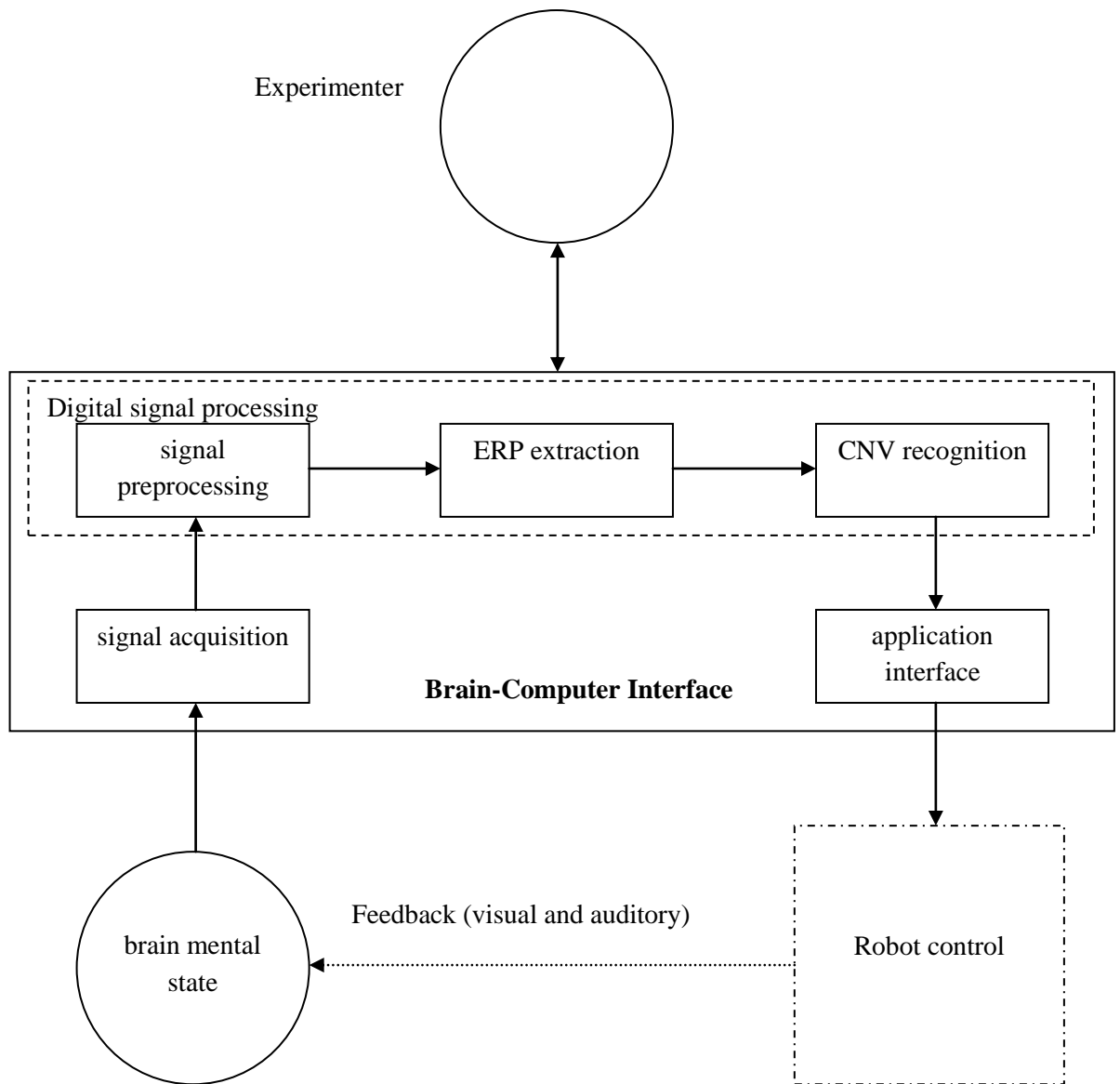

Figure 6.1. The BCI paradigm used in this research

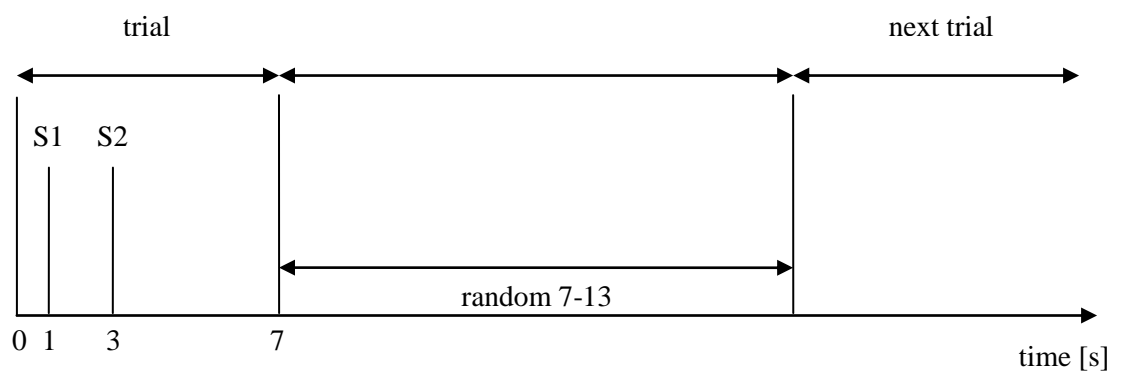

Figure 6.2. Time organization of the paradigm in trials and intertrials

After the signal has been processed and shown on the screen, the experimenter may decide that it contains a drift, is still full of other artefacts or for any reason unacceptable, and may decide to reject that trial. If so, then that trial is repeated and the rejected trial's data is discarded from further processing.

## 6.2. Algorithm for ERP Extraction

When the ERP has a constant form (as is the case with most of the evoked potentials), the resulting EEG can be formulated using the following equation:

$$EEG(t) = ERP + random(t) \quad (6.1)$$

where  $EEG(t)$  is the EEG signal, which is time varying and is a sum of the constant ERP and the  $random(t)$  portion of the signal, which is also time varying and is usually a combination of noise and other artefacts.

In the CNV flip-flop paradigm, this model would be presented as

$$EEG(t) = ERP(t) + random(t) \quad (6.2)$$

where  $ERP(t)$  is itself time varying. The problem thus becomes *how to extract a time varying ERP*.

One approach towards solving that problem is using the following algorithm

$$ERP(t) = p ERP(t-1) + q EEG(t) \quad (6.3)$$

where  $p + q = 1$  (6.4)

Both  $ERP(t)$  and  $EEG(t)$  above are vectors containing N samples. The scalar version of the equation (6.2.3) is

$$ERP(s, t) = pERP(s, t-1) + qEEG(s, t) \quad (6.5)$$

where  $s$  ( $s = 1, 2, \dots, N$ ) is the sample number in a trial,  $t$  ( $t = 1, 2, \dots, T$ ) is the experimental trial number, and  $p$  and  $q$  are weighted parameters, satisfying  $p + q = 1$ .

For the parameters ( $p, q$ ) in this research the values (0.9, 0.1) are used. It is convenient to write percentages instead of fractions, so for example, when  $p=90\%$  is used, the equation becomes

$$ERP(n) = 90\% ERP(n-1) + 10\% EEG(n) \quad (6.6)$$

The solution of that difference equation is

$$ERP(n) = 10\%EEG(n) + 9\%EEG(n-1) + 8,1\%EEG(n-2) + 7,3\% EEG(n-3) + \dots \quad (6.7)$$

which means that an algorithm is used that computes a discounting sum of all the EEG samples recorded in all trials before. The most current EEG is weighted 10% and the previous EEG signals take part in it in gradually more diminutive traces. In

other words, *this algorithm learns the new value of ERP, exponentially forgetting the previous values.*

### 6.3. Algorithm for ERP Extraction as a Neural Learning Algorithm

One can recognize that the algorithm used in this work can be viewed as a neural learning algorithm. Consider the ERP extraction algorithm again

$$ERP(t) = p ERP(t-1) + q EEG(t) \quad (6.3)$$

where  $p + q = 1$  (6.4)

where both **ERP** and **EEG** above are vectors containing N samples.

The algorithm above is a difference equation of type

$$\mathbf{w}(t) = p\mathbf{w}(t-1) + q\mathbf{x}(t) \quad (6.8)$$

which is a *neural learning algorithm*. The scalar version of the algorithm is

$$w_i(t) = p w_i(t-1) + q x_i(t) \quad (6.9)$$

where  $i$  is the sample index and  $i = 1, \dots, N$ .

Two additional forms can be written for the algorithm (6.9). Since  $q = 1-p$ , it yields

$$\mathbf{w}(t) = p \mathbf{w}(t-1) + (1-p) \mathbf{x}(t) = p [\mathbf{w}(t-1) - \mathbf{x}(t)] + \mathbf{x}(t) \quad (6.10)$$

or since  $p = 1-q$

$$\mathbf{w}(t) = (1-q) \mathbf{w}(t-1) + q \mathbf{x}(t) = \mathbf{w}(t-1) + q(\mathbf{x}(t) - \mathbf{w}(t-1)) \quad (6.11)$$

So the extraction algorithm (3) can be written as

$$ERP(t) = ERP(t-1) + q (EEG(t) - ERP(t-1)) \quad (6.12)$$

It means that the learning algorithm tries to find the approximation of the current ERP by using what is computed so far for the ERP and adds the discounted (by  $q$ ) difference between the current EEG and the previously learned ERP.

### 6.4. Algorithms for Computing ERP Parameters

Once the ERP is extracted in an experimental trial, a set of parameters are computed. Here a list of extracted parameters will be given and a mathematical algorithm for their computation. Figure 6.3. gives the time scale where the parameters are computed.

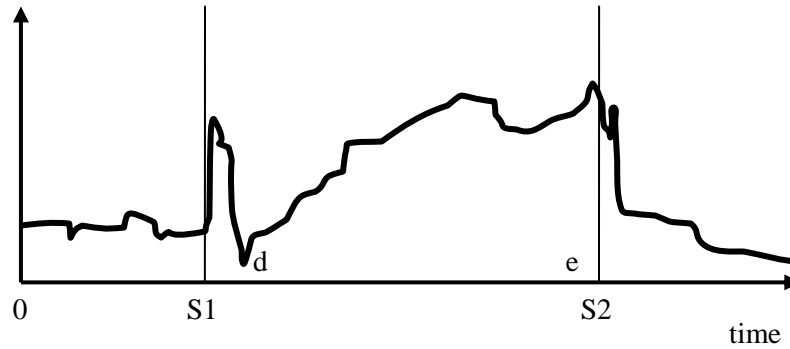

Figure 6.3. Time scale and ERP parameter computation

Following are the algorithms for computing the relevant ERP parameters:

$$\mathbf{Ref0} = \text{MEAN}_{0 \text{ to } S1} \text{ erp baseline signal } [\mu\text{V}]$$

$$\mathbf{AMP} = \text{MEAN}_{S2-e \text{ to } S2} \text{ erp} - \text{MEAN}_{0 \text{ to } S1} \text{ erp} \quad \text{signal amplitude difference } [\mu\text{V}]$$

$$\mathbf{SLOPE} = \text{b(REGR}_{S1+d \text{ to } S2} \text{ erp)} \quad \text{signal linear regression slope } [\mu\text{V/s}]$$

In the above algorithms, the values d and e define small intervals (500ms and 50 ms respectively) around S1 and S2 in which the computation is performed. The functions MEAN and REGR represent mean value and regression slope functions in the specified intervals respectively.

## 6.5. Algorithms for Recognizing the ERP as a CNV

The pattern recognition module decides whether the current ERP can be classified as a CNV. The key parameters are the slope of the regression angle and the ERP amplitude difference near S1 and S2. In the experiments, the ERP amplitude is used, which is computed as the parameter AMP defined above, which is the difference between the amplitude before S2 and the baseline. The decision whether the ERP is a CNV is made after comparing AMP with a threshold value. And it should happen three times in a row that AMP is greater than the threshold, in order for the CNV to be acknowledged.

In programming notation

In CNV forming phase  
 if (AMP > threshold) = true in three consecutive trials  
 then ERP = CNV

In CNV decaying phase  
 if (AMP < threshold) = true in two consecutive trials  
 then ERP ≠ CNV

## 6.6. A Neural Element for CNV Computation

For computing the CNV, a special type of artificial neural element is introduced here. First, the standard model of artificial neuron is considered, given in Figure 6.4. It contains excitatory synapses and inhibitory synapses. Each synapse has its weight (influence) on the neural potential formed in the neuron. Let  $\mathbf{x}_{exc}$  and  $\mathbf{x}_{inh}$  be the vectors of excitatory and inhibitory synapses respectively. Let  $\mathbf{w}_{exc}$  and  $\mathbf{w}_{inh}$  be the corresponding weight vectors. Let PSP be postsynaptic potential, i.e. the internal neural potential which develops inside the neuron because of the synaptic activity. The weighted sum of all excitatory synapses is computed as a vector inner product  $SUM_{exc} = \mathbf{w}_{exc}\mathbf{x}_{exc}$ . Analogously,  $SUM_{inh} = \mathbf{w}_{inh}\mathbf{x}_{inh}$  shows the weighted sum of all inhibitory synapses. The PSP is a function of those weighted sums, i.e. the influences of all excitatory and all inhibitory synapses.

$$PSP = f(SUM_{exc}, SUM_{inh}) \quad (6.13)$$

According to Figure 6.4., the neuron will send out a signal of 1 if  $PSP > \Theta$ , and otherwise it won't.

A McCulloch-Pitts artificial neuron [McCulloch and Pitts, 1943] computes the PSP according to the following equation:

$$PSP_1 = SUM_{exc} - SUM_{inh} \quad (6.14)$$

i.e. as a difference of the sum of all excitatory synapses and the sum of all inhibitory synapses. Figure 6.4. shows a McCulloch-Pitts artificial neuron.

The neuron proposed in this work computes its internal potential slightly differently:

$$PSP_2 = SUM_{exc}/N_{exc} - SUM_{inh}/N_{inh} \quad (6.15)$$

where  $N_{exc}$  is the number of excitatory synapses and  $N_{inh}$  is number of inhibitory synapses. In other words, the neural potential is computed as the average of the excitatory minus the average of the inhibitory synapses.

$$PSP_2 = MEAN_{exc} - MEAN_{inh} \quad (6.16)$$

This type of neuron is used to compute the CNV using a neural network.

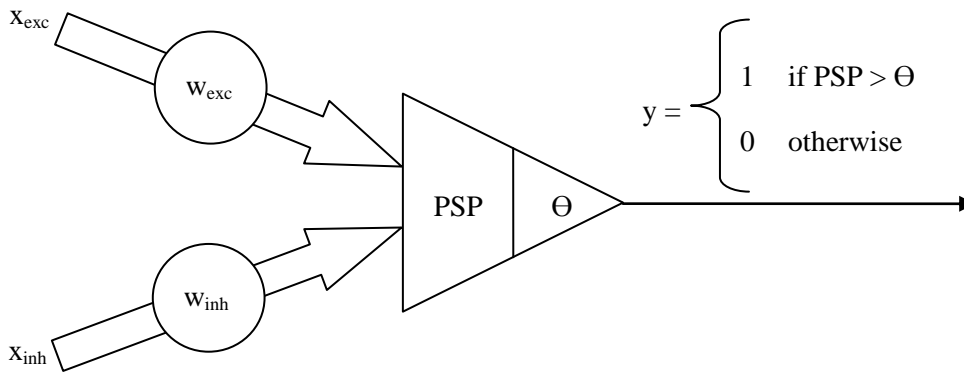

Figure 6.4. The McCulloch-Pitts artificial neuron

An additional feature of this artificial neuron is introduced – the occurrence threshold  $\tau$ . It is a number of times that the event  $\text{PSP} > \theta$  must occur before the neuron fires. For example, if  $\tau = 3$ , then it needs three times in a row  $\text{PSP} > \theta$  to happen in order for the neuron to fire. Figure 6.5. shows the artificial neuron proposed in this work.

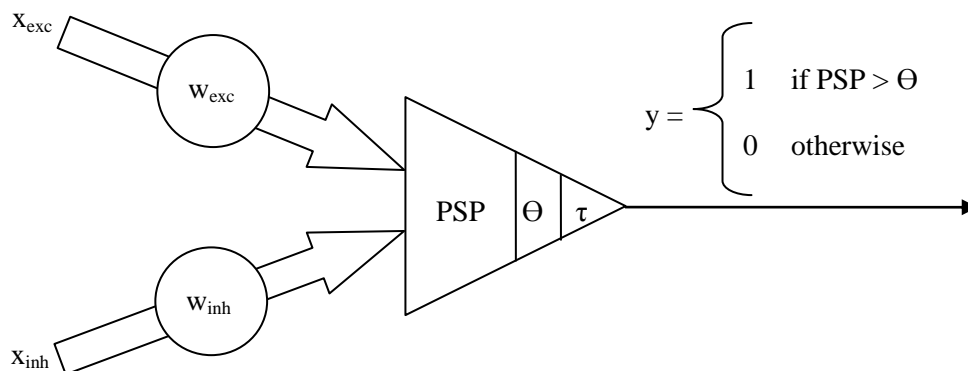

Figure 6.5. The artificial neuron proposed in this work

## 6.7. A Neural Network for CNV Computation

Using this neural element, a neural network is now proposed, that computes the CNV given series of EEG traces. Figure 6.6. shows the neural network.

The neural network shown in Figure 6.6. takes 700 samples from 7 seconds of EEG recording from each trial of the CNV flip-flop paradigm. Using a neural learning algorithm, it extracts the ERP in each trial. The first 100 samples are considered inhibitory inputs and the samples between 295 and 300 are considered excitatory inputs. The neuron computes the internal PSP potential by taking averages of both the excitatory and inhibitory inputs, which is then compared to the threshold

(5 $\mu$ V). If the PSP is above the threshold 3 times, the neuron fires and CNV is acknowledged.

This is the neural network implemented in the software that extracts ERP and recognizes CNV for given series of EEG recording trials.

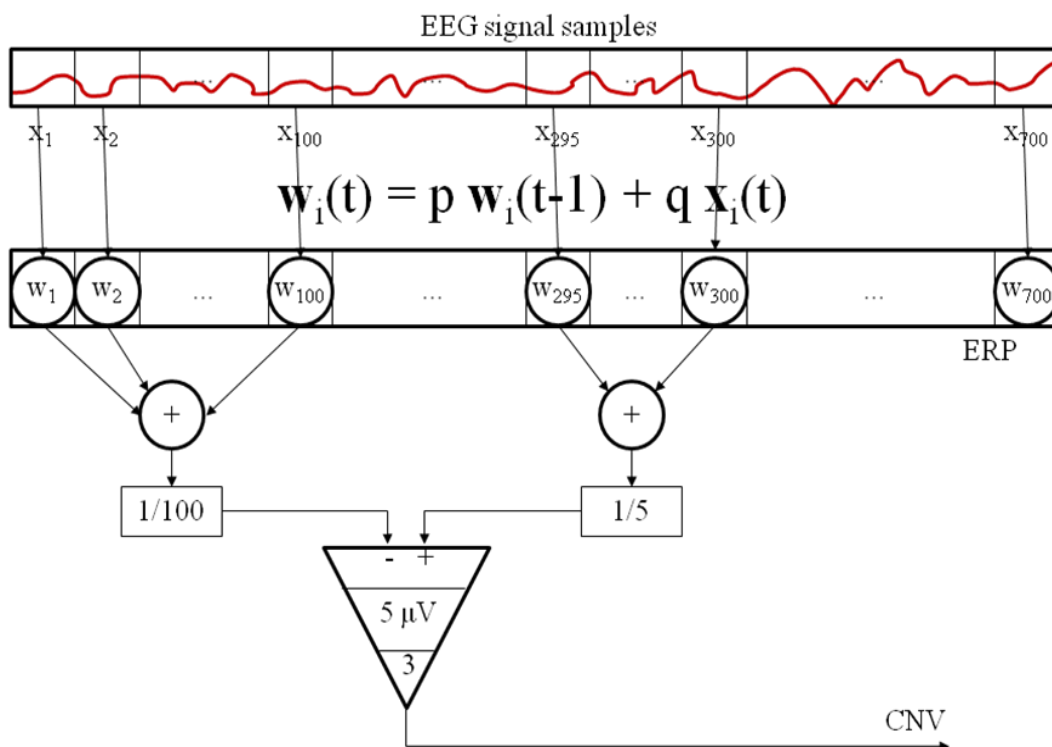

Figure 6.6. Neural network algorithm for extracting a time-varying ERP and recognizing CNV



## **Chapter 7**

# **DESIGN MODEL FOR BCI SOFTWARE**

A generic design model for BCI software implementation, proposed in this chapter, is based on the implementation of the BCI paradigm carried out in this work. Its modules are presented, with an emphasis on their object-oriented nature.

## 7. DESIGN MODEL FOR BCI SOFTWARE

Since the appearance of BCI and direct brain bioelectric control of devices, software systems were used to perform central functions of a BCI. Specific BCI functions that should be taken into account in building a BCI software system are experimental paradigm control, biosignal acquisition, biosignal processing, decision making, device interface, and graphical user interface. The specifics of BCI software can be addressed from the standpoint of software engineering. Recently within software engineering, the concept of *design model* was introduced. By that approach, a group of applications has a specific pattern, i.e. a design model.

One of the issues in BCI is the lack of standardized software architecture for a BCI system. Based on the BCI software design in this work, in this chapter a generic BCI architecture will be proposed.

### 7.1. BCI Design Model: Proposal

Figure 7.1. shows five modules that constitute a design model for a BCI application. They are biosignal acquisition module, device control module, graphical user interface module, file control module and the experimental paradigm control module.

**Biosignal acquisition module.** This module is the interface between the computer and the biosignal acquisition hardware. It depends on the specific hardware, as well as on the operating system and development environment of the software used.

**Device control module.** Similar to the previous, this module is the interface between the computer and the device controlled by the BCI. Again, it depends on the specifics on the device and also the software system used by the computer.

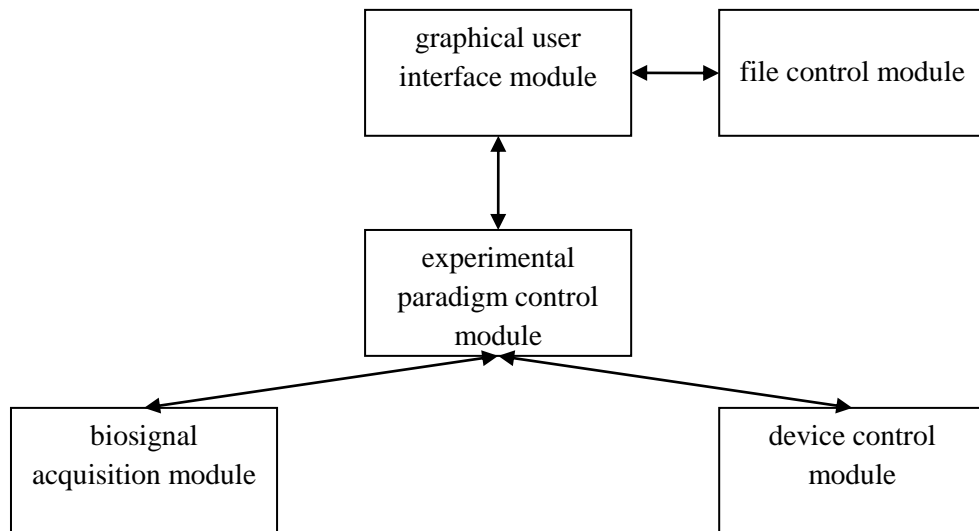

*Figure 7.1. A generic BCI design model*

**Experimental paradigm control module.** This module controls the experimental paradigm, i.e. the specifics of its realization. It controls the biosignal acquisition, as well as device operation. It is the module that is active during application run-time, and also controllable by the experimenter.

**Graphical user interface module.** This is the module that shows the results of the experiment on the computer screen. It's safe to assume that all BCIs must have some sort of a graphical interface, since the signals from the brain must be shown either as EEG curves, or magnetic resonance areas, or any other graphical form, to be understandable to the user and/or experimenter. Even though the data from the subject is most commonly delivered in digital format, displaying numbers on the screen would not be understandable or useful, so the graphical user interface (or GUI) module must make sure that the data get displayed visually and understandably.

**File control module.** The experiment data are almost always stored for later review and analysis, so there must be some way of keeping track of them, i.e. maintaining a database of experimental results. This is what the file control module does, and, because the stored experiments must also be viewable for the user, it works closely with the GUI module.

## **7.2. BCI Design Model: Implementation**

Figure 7.2. shows the complete implementation the BCI system presented in this work. Since it has been developed in the C# language, the structure of the system is object-oriented. Furthermore, Figure 7.3. shows the individual BCI modules and their location in the system structure. It can be seen in the figures that both software

and hardware elements compose the system. The hardware devices shown are the signal acquisition hardware (i.e. Biopac MP35 biopotential amplifier in this case) and the device(s) controlled by the BCI (i.e. the Lynx robotic arm(s) and the corresponding servo-controller(s)).

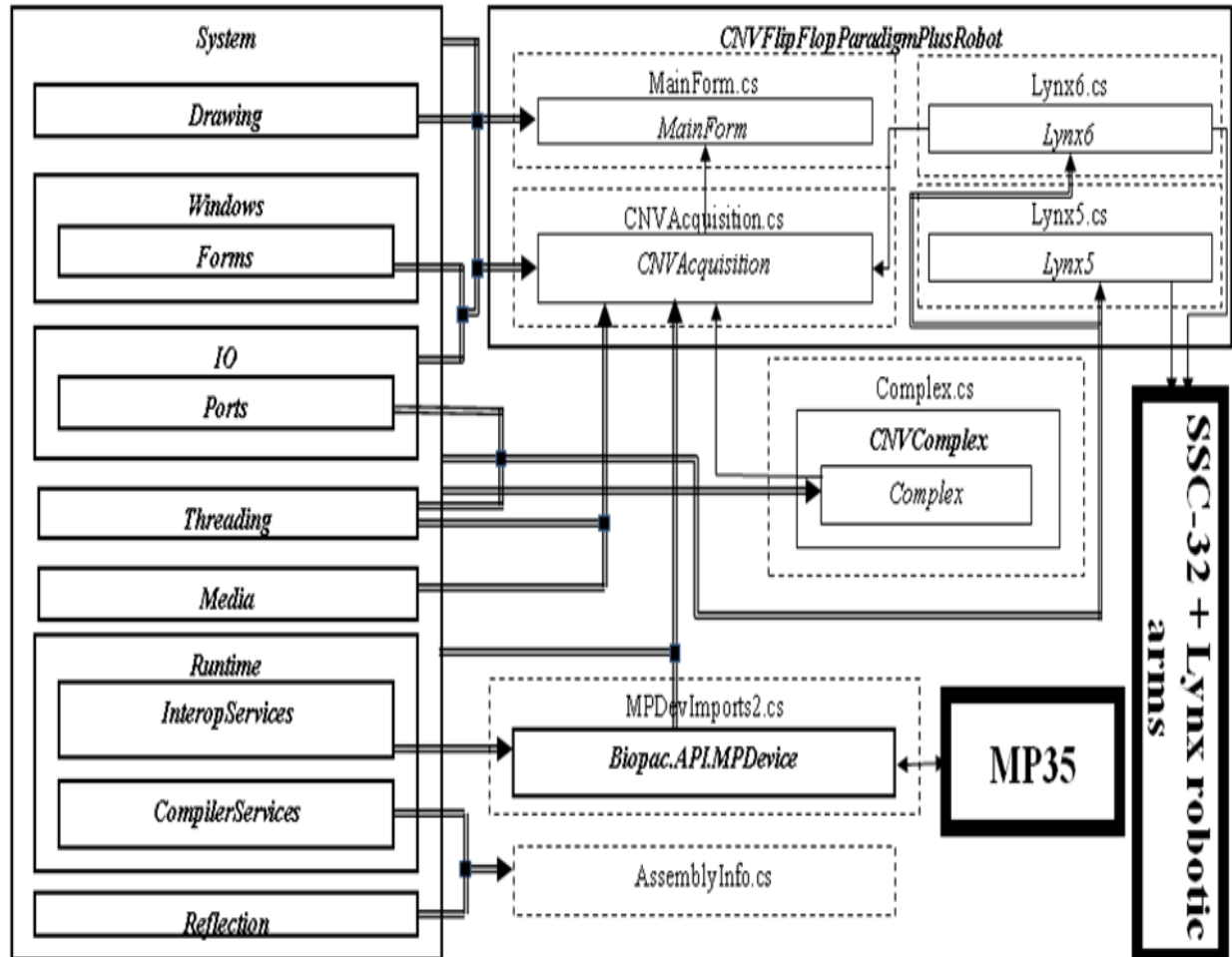

Structures and legend

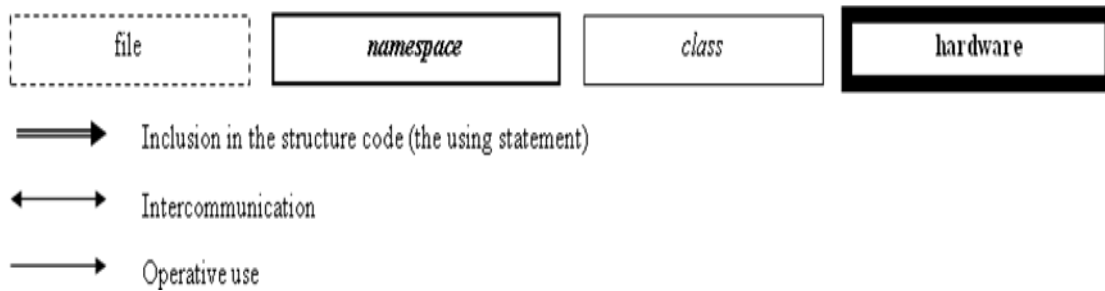

Figure 7.2. The structure of the BCI implementation in this work

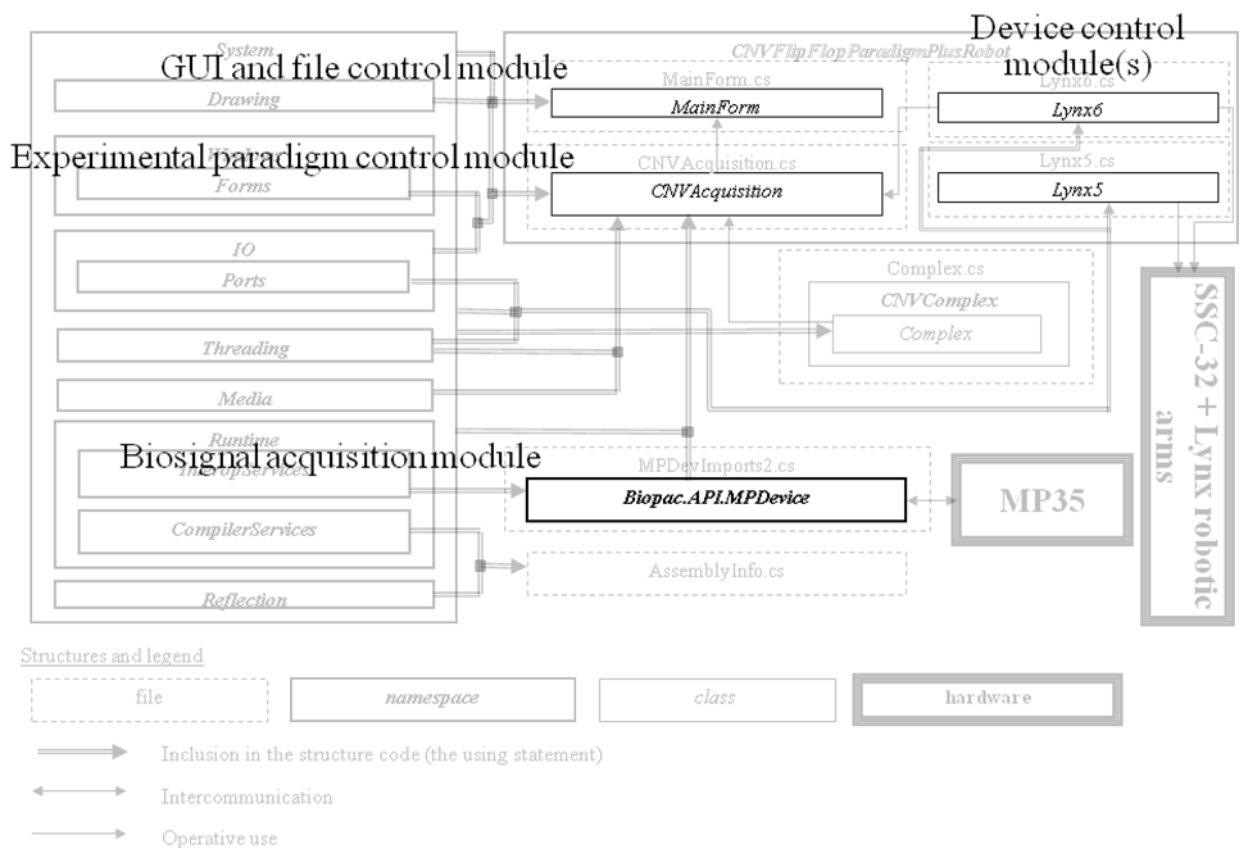

Figure 7.3. The BCI modules used in the implementation

### 7.3. BCI Design Model: Modules

In this section, a slightly more detailed overview of the BCI modules, that are used in the BCI implementation, is given. Here, only the software modules will be explained, whereas the hardware equipment will be explained in more detail in the next chapter.

#### 7.3.1. The Biosignal Acquisition Module

This module consists of software device drivers to communicate with the biopotential acquisition device, in this case a Biopac MP35 biopotential amplifier. The device drivers are obtainable with the purchase of the device, but the real advantage of using this device is its programmability. A special C# namespace is also available, which offers methods for controlled acquisition of the MP35, which can then be utilized to serve a special purpose. In this case, the MP35 is programmed to serve the needs of the CNV flip-flop acquisition.

### 7.3.2. The Device Control Module(s)

If there is a device controlled, a device control module must be present. In this case, two robotic arms are controlled, hence two device control modules are present. They are represented by two C# classes: one named Lynx6, which communicates with the Lynxmotion Lynx6 robotic arm, and the other is named Lynx5, which communicates with the Lynxmotion Lynx5 robotic arm. Both robots' servo-controllers accept commands through serial ports, and such communication is achievable using the C# language, so messages are sent to the robots using methods available in these classes.

### 7.3.3. The Experimental Paradigm Control Module

As shown in Figure 7.4., the acquisition of signals takes place during the trials, whereas the signal processing and BCI parameter calculations take place in the intertrials. The parameters are then used to determine whether a CNV signal has appeared, whether a robot should be moved and so on.

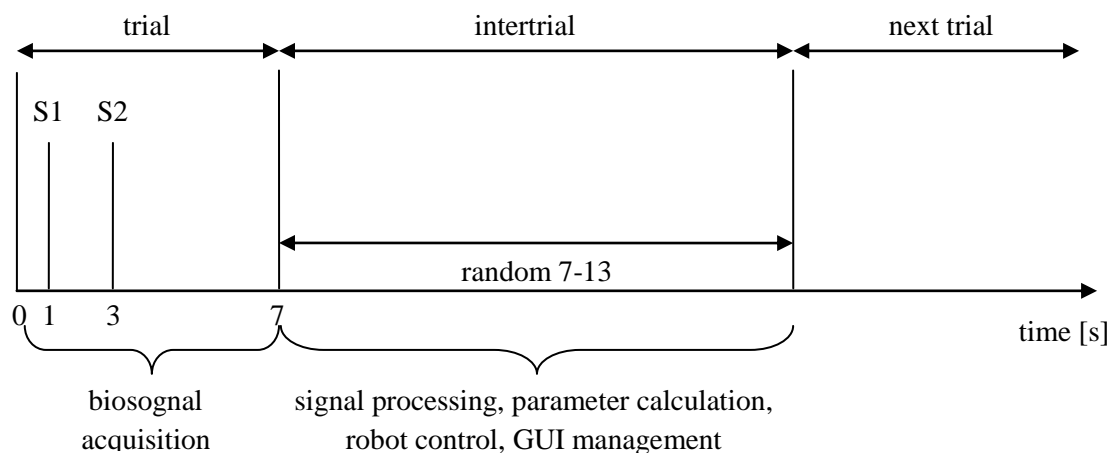

Figure 7.4. Time organization of the paradigm in trials and intertrials

### 7.3.4. The Graphical User Interface (GUI) Module

This module displays all the relevant experiment data in a manner understandable by the user. Figure 7.5. shows a screen of the GUI. It is divided into signal display and experiment data display.

The screen is designed in such a way that it shows an experimental trial. It contains two distinctive parts: a signal display part and an experiment data part, which is divided into subject data and experiment data.

The signal display part shows 6 channels of data on the same time scale of 7 seconds. The first four channels are recording channels: EEG, EMG from the press

button pressing hand, EOG, and press button length are shown. The fifth channel is the Control Signal sent to the device. It is present only occasionally, when there is a signal sent to the robots. The last sixth channel is the ERP channel. In the situation shown, the extracted ERP is recognized as a CNV, as noted on the right part of the screen.

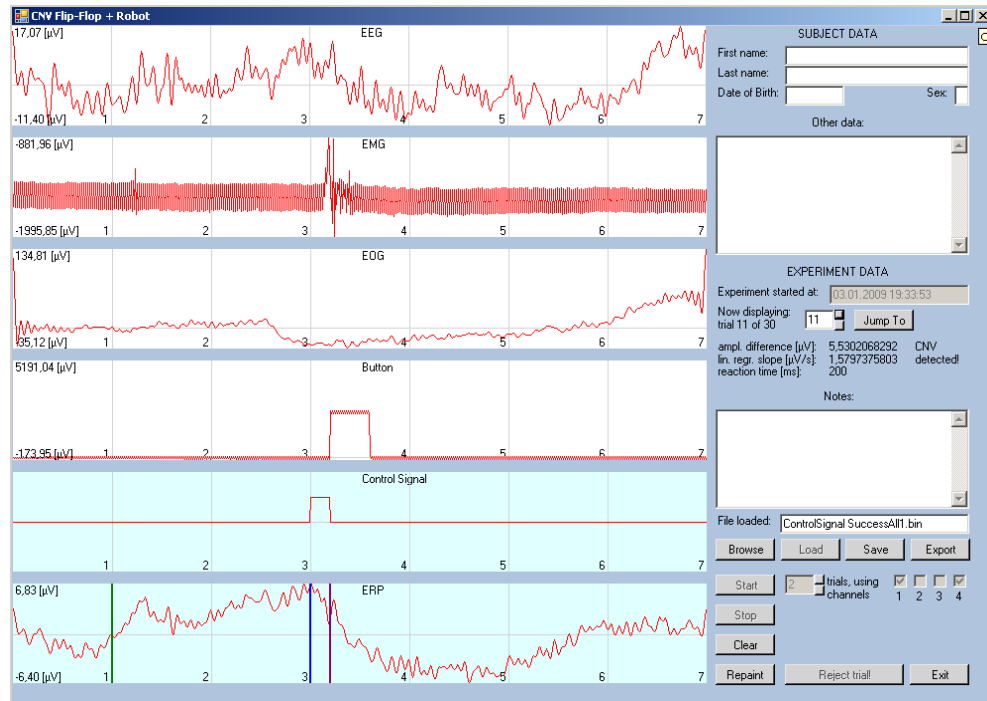

Figure 7.5. The screen design part of the graphical user interface (GUI) module

The subject data part collects information about the subject, name, age, sex, and other data.

The experiment data part contains several sections. First, it shows when the experiment started, date and time. It also shows the number of the trial that is currently shown on the screen. The experimenter or analyzer of the experiment has an option to see any experimental trial of this particular experiment. Then, the data about the current ERP parameters are shown, that are taken into account for the CNV appearance/disappearance decision. If the CNV is detected, it is also acknowledged, as in the case on Figure 7.5. The Notes text field collects notes about the experiment from the experimenter.

The last part of the experiment data contains experiment control options. It includes which channel to be recorded and how many trials to be carried out. The Start button starts a new experiment and the Stop button can stop an experiment before the preset number of trials has elapsed. The Clear button will clear the screen and all the generated data, discarding it from memory. Repaint will show the experiment trial shown in the Now Displaying data field, if the image has been lost

due to window minimization, for example. The Reject button will reject the current trial, possibly because the experimenter noticed obvious artefacts. Finally, the Exit button will exit the program.

Several buttons on the screen in Figure 7.5. are designed to deal with the experiment files, and can be considered a part of the file control module (this is why, among other things, on Figure 7.3., both the GUI module and the file control module are shown in the same class). The Browse button browses in the experiment directory which experiment to be shown for analysis. The Load button loads the experiment data file. The Save button saves the current experiment with the name shown chosen by the experimenter. The Save button saves the experiment in a .bin (binary) file. An experiment .txt (text) file is generated using the Export button. These are explained as follows.

### **7.3.5. The File Control Module**

This module deals with the data collected during the course of the paradigm realization, i.e. its storage, export and retrieval.

These data are initialized at the beginning of the experiment. The most relevant data are the values of each acquisition sample in each channel in each trial, and therefore the key value is the number of trials in the experiment, which is always stored first. It is possible that not all 4 channels of the MP35 have been used, and data about which channels have been used is stored next. Following them are the data about the subject (first name, last name, sex, date of birth), as well as data about the experiment (diagnosis, experiment date, experiment notes). Then, trial-dependent data are stored, such as the value of each sample in each channel (which takes the largest amount of memory), the CNV recognition parameters (amplitude difference and slope), the reaction time, whether CNV has been recognized in that trial, whether S2 was administered in that trial, and also which robot has moved and using which behavior, if any.

All of these data are stored in the RAM, i.e. the operational memory, for the duration of the experiment. At the end of the experiment, all the data can be written as a binary file, and also textual representation of the data can be exported as a text file (Figure 7.6.). The binary file can later be loaded into the software program, and thus the experiment data can be reproduced at a later time. The text file, on the other hand, can be used to extract data which can be used for other purposes, like statistical calculations, for example.



RELEVANT TRIAL DATA FOR EXPERIMENT DONE ON 03.01.2009 17:47:59

Subject:      Date of birth:      Sex:

Other data: none

Recognition parameters:

Amplitude difference:      5 [ $\mu$ V]

Linear regression slope: 3.6 [ $\mu$ V/s]

Trial	Ampl.diff[ $\mu$ V]	Rgr.slope[ $\mu$ V/s]	CNV	S2	Reac.time[ms]
1	0,5714519765	-0,2052679709	False	True	350
2	2,5522192643	-0,6251843186	False	True	320
3	1,8609022851	-0,8240090533	False	True	310
4	4,6102989909	-0,8095393023	False	True	250
5	5,3817953670	-1,2189364127	False	True	260
6	5,6088257790	-2,0034099774	False	True	200
7	4,0126344040	-1,6297823960	False	True	210
8	4,4432145453	-1,7606259425	False	True	200
9	3,4326213893	-1,5323060820	False	True	210
10	5,7102406045	-0,6272841592	False	True	210
11	5,5990220290	-0,7641709436	False	True	200
12	6,3037339170	-0,8176551087	True	True	210
13	6,4753174273	-1,4676593642	True	False	n/a
14	6,2375162288	-1,0281176426	True	False	n/a
15	5,6968893777	-1,0189252420	True	False	n/a
16	6,0853722360	-0,7391625463	True	False	n/a
17	8,7718380501	-0,2617799521	True	False	n/a
18	7,8771015730	0,4327445488	True	False	n/a
19	6,3495148634	0,1257781550	True	False	n/a
20	6,8722250614	0,7205715811	True	False	n/a
21	5,9885209787	1,5134721593	True	False	n/a
22	5,1680190138	0,9929997497	True	False	n/a
23	4,4430567928	2,5181157809	False	False	n/a
24	1,6207181710	1,8887387855	False	True	980
25	3,3223991822	2,6431792463	False	True	190
26	3,5215410840	2,3589461813	False	True	190
27	5,2366729240	2,3631201226	False	True	160
28	5,3047791874	2,3121524229	False	True	200
29	5,9965265994	1,6818804998	True	True	190
30	6,6610297817	0,9990884007	True	False	n/a

Experiment notes:

*Figure 7.6. An example of .txt file generated by a CNV flip-flop experiment*

## **Chapter 8**

### **MATERIALS AND METHODS**

This chapter deals with the practical issues of the BCI implementation in this work. The used hardware (biosignal acquisition units, robotic arms and the computer itself), the subjects (i.e. how they are prepared for the experiments) and the experimental procedure are presented.

## **8. MATERIALS AND METHODS**

This chapter gives a more detailed description of the hardware equipment used in the CNV flip-flop paradigm realization, as well as its use and interconnection.

### **8.1. BCI Devices: Biosignal Acquisition Equipment**

The communication between the subject and computer is carried out through the MP35 biopotential amplifier (Figure 8.1.), a product of the company Biopac Inc. This amplifier amplifies the signal up to 50 thousand times, and is therefore, as well as because of its programmability, suitable for neurophysiological experiments carried out in this work.

MP35 has 4 analog channels, through which it can collect data from the subject. Electrode leads (Figure 8.2.) are connected to those channels, where each lead is connected to an active electrode, a reference electrode and a ground electrode. There are several different types of leads, where it's possible that the cables to the active and referent electrode also have additional shielding electrodes. The ground doesn't have a shield. For the purpose of this work, special leads have been ordered, which have a built-in entry DC amplifier with a large input resistance (9 megaohms) and a time constant of 10 seconds.

Since this paradigm is non-invasive, quality surface electrodes are used. Figure 8.3. shows the electrodes and the accompanying materials, used during the experiments.

There are two types of electrodes. The first type of electrodes are vinyl electrodes, usable only once. They have an adhesive band, in the centre of which there is the conductive part, through which the potentials are received. The conductive part itself is covered with a sponge cover, on which there is a little

conductive gel, so as to augment the electrical conductance on that part. Despite the ease of setup and removal of these electrodes, they are only usable on spots where there's plenty of space, and absence of hair, like arms, legs and face. These electrodes would be useless on the scalp, however, due to the interference from the subject's hair (unless the subject is bald).



*Figure 8.1. Biopac MP35 biopotential amplifier*



*Figure 8.2. Electrode leads used in the CNV flip-flop paradigm*



Figure 8.3. Electrodes and accompanying materials used during experiments using the MP35 biopotential amplifier

Therefore, standard Ag/AgCl electrodes are used, which can be used more than once. The electrodes used in this work are also manufactured by Biopac Inc. and have a circular shape, with a little hole on one side, into which conductive gel can be inserted, and on the other side they have small barbs, by which the electrode attaches to the skin of the subject. This is especially useful for setting up the electrodes on the scalp, because the electrode encompasses a relatively small area, so the hair of the subject can be put aside just enough so as not to obstruct. In order for the electrodes to be better attached, they are filled up with conductive gel, also a product of Biopac Inc. (shown on Figure 8.3.).

## 8.2. BCI Devices: Robotic Arms

In the experimental work, two types robotic arms, manufactured by Lynxmotion Inc., were used: Lynx6 with 6 degrees of freedom (DOF) and Lynx5 with 5 DOF. Figure 8.4. shows both robots in a position to perform a task of solving the three-disk Towers of Hanoi problem (i.e. TOH(3)).



Figure 8.4. Two robotic arms used in the BCI experiments

Both robots utilize an SSC-32 microcontroller each, also a product of Lynxmotion. This microcontroller controls the robot motor movements and enables their open-loop control, respective to the computer. In other words, the computer can simply send a signal to the controller as to which motor needs to be moved to which position, and the controller will ensure that this get accomplished; the commands from the computer get transformed to electrical impulses that move the motors by the microcontroller.

The method used to control robots is the behavior based method [Arkin, 1998]. Figure 8.5. shows the method.

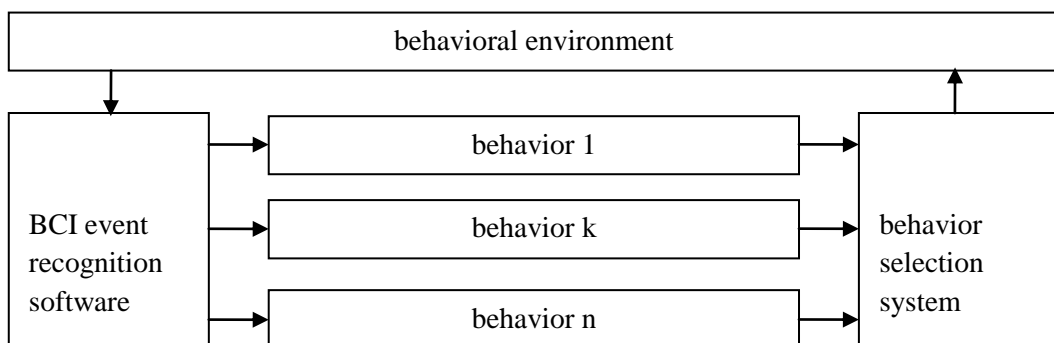

Figure 8.5. Behavior based method for controlling robots using BCI

According to the behavior based method, several behaviors are preprogrammed. The behaviors are activated by a BCI system that recognizes a

particular brain state. Therefore, the behaviors are preprogrammed and executed by a BCI signal, in a sequence that would ensure the solution of the task, in this case the Towers of Hanoi problem.

### 8.3. BCI Devices: Computer

Since MP35 converts the signals from analog to digital form, it is logical for the data to be further processed on a computer. Any computer configuration commercially available nowadays would suffice the requirements of the paradigm, since almost all of them have built-in graphics and sound cards, and the sampling rate is 100 Hz, which is far less than every computer microprocessor nowadays available. The operating system required is Windows XP, but Windows Vista is also acceptable.

The communication between the computer and BCI specific devices is shown on Figure 8.6. The software system was developed in the C# language, using the .NET 2.0 development environment.

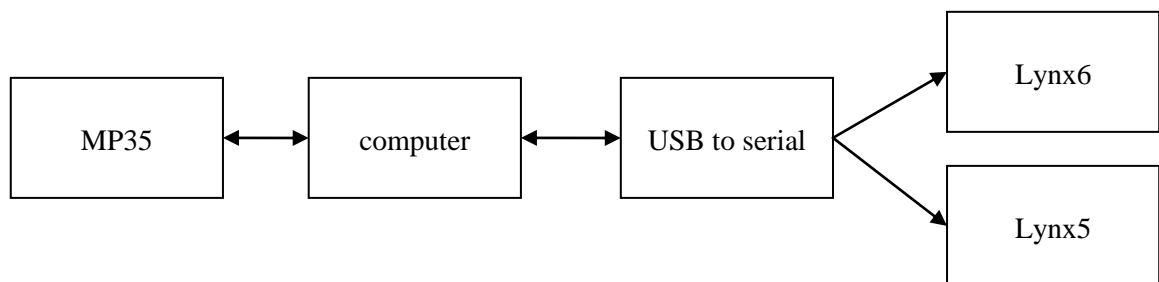

*Figure 8.6. Communication among BCI devices*

MP35 communicates with the computer through a USB port, i.e. data collected from the electrodes are converted to digital form and sent to the computer through the USB port. The device drivers for the amplifier enable it to be accessed directly, i.e. be programmable.

The Lynx robotic arms that are used require serial communication. Since the new laptops do not support serial ports, a USB port is used and a USB to serial converter is needed for the communication with these serial devices. The converter itself comes with device drivers, that enable the computer to recognize the ports on the interface as serial ports of the computer.

### 8.4. Subjects in the Experiments

This experimental work serves just the purpose of a proof of the concept. Therefore, this is not a population-intensive research and is not intended to conclude



anything about a population. Thus, just several subjects were included in the experiment.

To be able to conduct the experiment properly, the subject must first be prepared. The preparation consists of setting up the electrodes on the subject's head, and also face and arm, as needed for the EOG and EMG recording, respectively. Figures 8.7. to 8.9. show the preparation of the subject for measurement, the instrumentation, as well as the outlook of the setup of the subject, instrumentation and experimenter during the conducting of the paradigm.

First, electrodes are connected to the subject's head. The active electrode is on Cz, the referent on the mastoid and the ground on the forehead, according to the standard 10-20 system. All electrodes are Ag/AgCl and are attached using a conductive gel, whereas the referent and ground electrodes are additionally affixed on the skin using a medical adhesive tape. Electrode connectors enable the resistance between the electrodes to be measured, and if it is less than 5 kilohms, the setup is considered solid.

When necessary, electromyogram (EMG) and electrooculogram (EOG) electrodes are placed as well, according to figures 8.10. and 8.11., respectively [Biopac Systems Inc., 1998-2003]. They don't affect the experiment directly, but are useful as hints to the experimenter, whether a certain trial should be rejected.



*Figure 8.7. Placing the electrodes on the subject's head*





*Figure 8.8. Experimental procedure*



*Figure 8.9. The instrumentation and its interconnection*

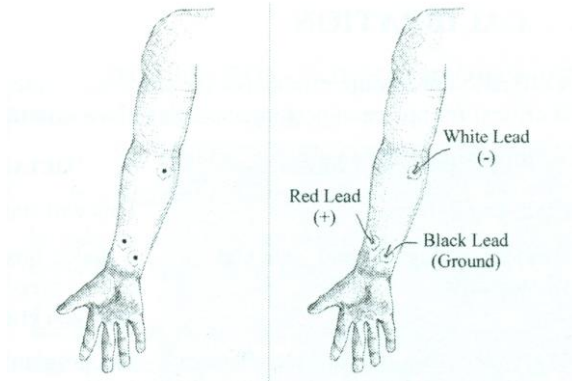

Figure 8.10. Placement of the EMG electrodes

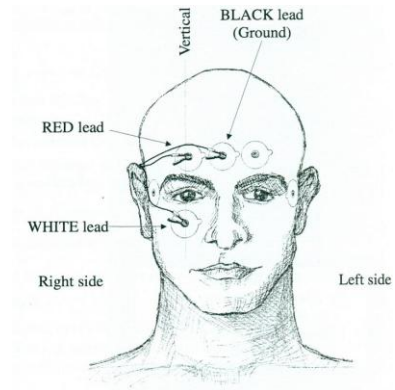

Figure 8.11. Placement of the EOG electrodes

The subject lies on a comfortable couch and usually keeps his/her eyes closed, so as to minimize the artefacts due to eye movement. The data from the subject are collected during the course of the experiment, whereas the experiment can have a predefined number of trials. Most commonly, 100 trials per experiment were performed.

During the experiment, the subject hears stimuli S1 and S2, which are crucial for successful realization of the paradigm. S1 has a fixed length of 200 milliseconds, and a frequency of 300 Hz. S2 has a frequency of 3000 Hz and its duration is determined by the subject's reaction time – it lasts until a pushbutton press is detected.

## 8.5. Experimental Procedure

The procedure implemented in each trial of the experiment is shown in Figure 8.12. It is initiated by the experimenter, by clicking a certain button on the computer screen. Every trial starts with one second of “empty” recording, where signals from the subject are collected without the presence of stimuli. After that one second, stimulus S1 is applied, and 2 seconds afterwards, stimulus S2 is applied. After that, there are 4 more seconds of recording, where the pushbutton press is recorded, as well as the resulting potentials after S2. Thus, the total trial time is 7 seconds, after which the intertrial begins, which lasts randomly, from 7 to 13 seconds. Therefore, the total time between trials ranges from 14 to 23 seconds. All recording takes place during the trials, and the signal processing, robot movement and GUI representation takes place in the intertrials.

Figure 8.13. shows a more elaborate view of the procedure in each trial of the experiment, where the experimenter interaction is also included. The texts shown in bold are the commands that can be given through the GUI. It is shown that the experimenter starts the experiment, and can also stop it, during the acquisition phase, or during the intertrial pause. Once the experiments runs out of trials or is manually stopped by the experimenter, it enters the survey mode, where the past experiments

can be viewed. It is at this time that the experiment is saved or exported to a text file on the disk. Also, if an experiment is loaded from the disk, it is viewed in the survey mode as well. In order to start the next experiment, the memory must first be cleared, as shown from the image. The experimenter can also exit the program at any time.

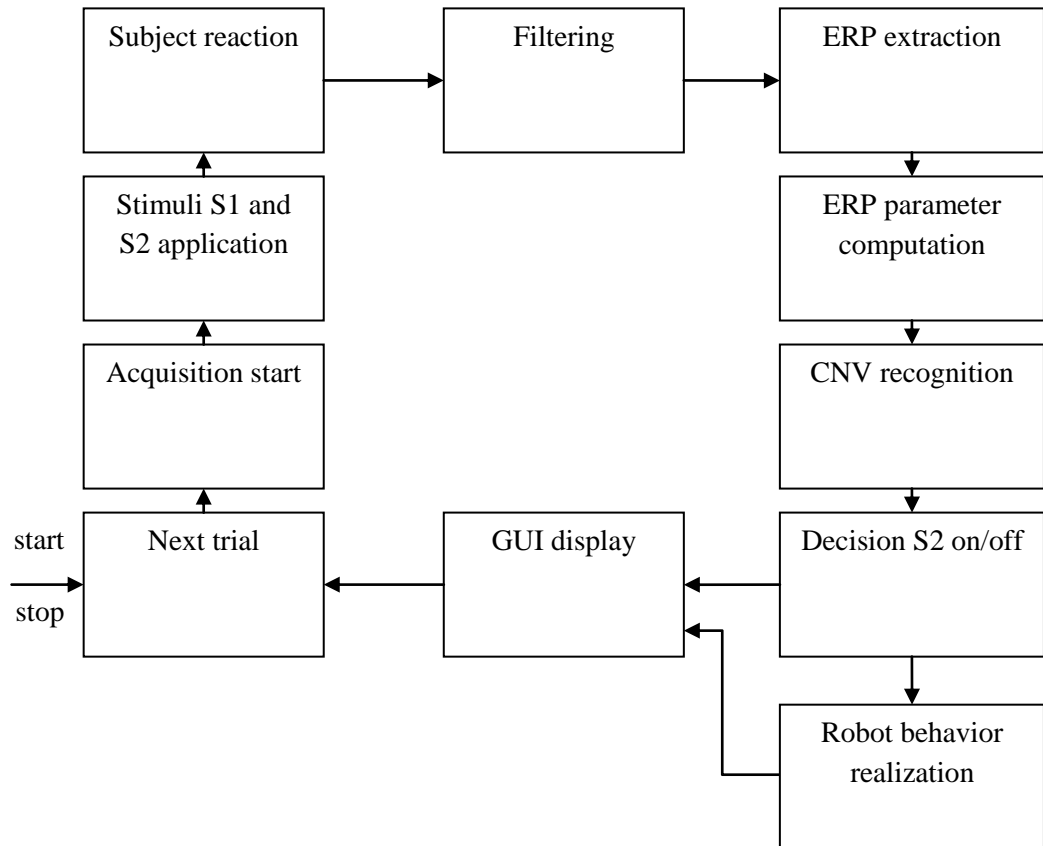

Figure 8.12. The control procedure for each trial of the experiment

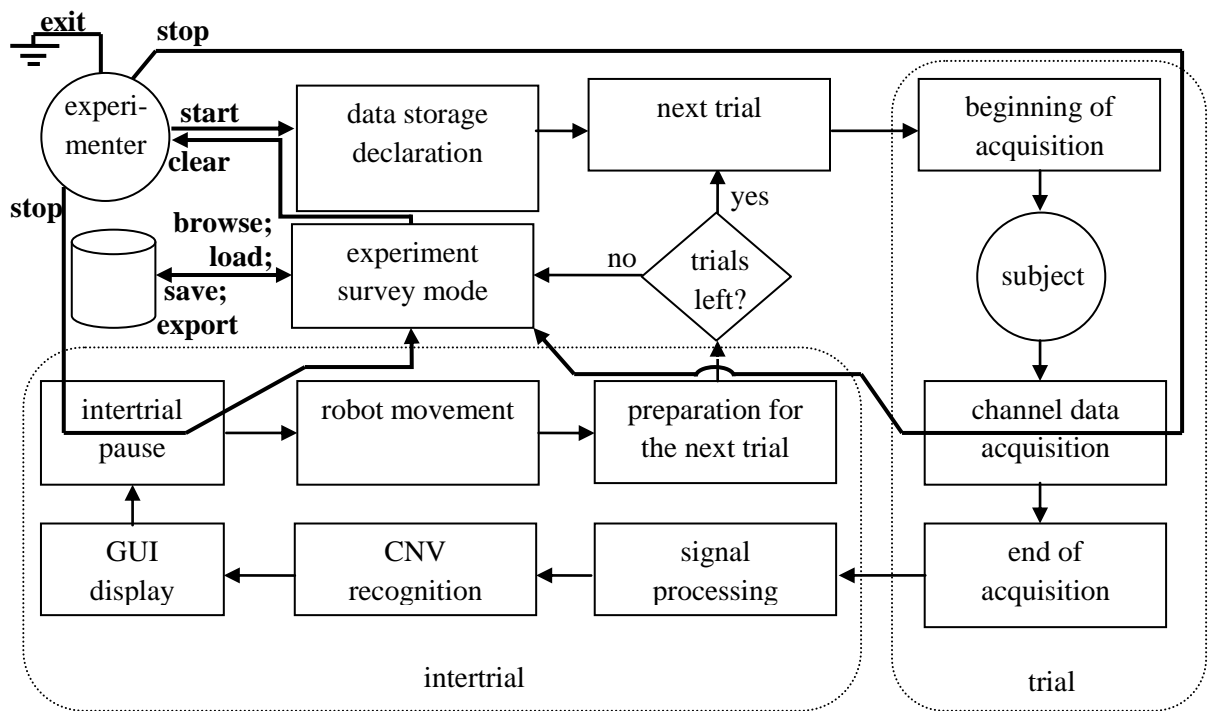

Figure 8.13. The control procedure of an experimental trial, elaborated

## **Chapter 9**

# **BCI BASED ON ANTICIPATORY BRAIN POTENTIALS**

This chapter presents a new BCI, created as a synthesis of the notions discussed in previous chapters. It first demonstrates how the CNV flip-flop paradigm is a BCI paradigm, and presents the challenge and solution of controlling a robotic arm to solve a common problem. Also, the challenge and solution of simultaneous control of two robotic arms are presented.

## 9. BCI BASED ON ANTICIPATORY BRAIN POTENTIALS

This chapter provides a synthesis of all the previous chapters, by showing the practical realization of the CNV flip-flop paradigm, and its use as a BCI. The control of one and then two robots, using this BCI, which is based on anticipatory brain potentials, is described. Experimental results are shown, as well as their explanations.

### 9.1. The CNV Flip-Flop Paradigm as a BCI Paradigm

The first observation, that the CNV flip-flop paradigm is actually a BCI paradigm, was made in 2005 [Božinovski, 2005]. Figure 4.1. shows this observation, but it is repeated here, as Figure 9.1., for clarity.

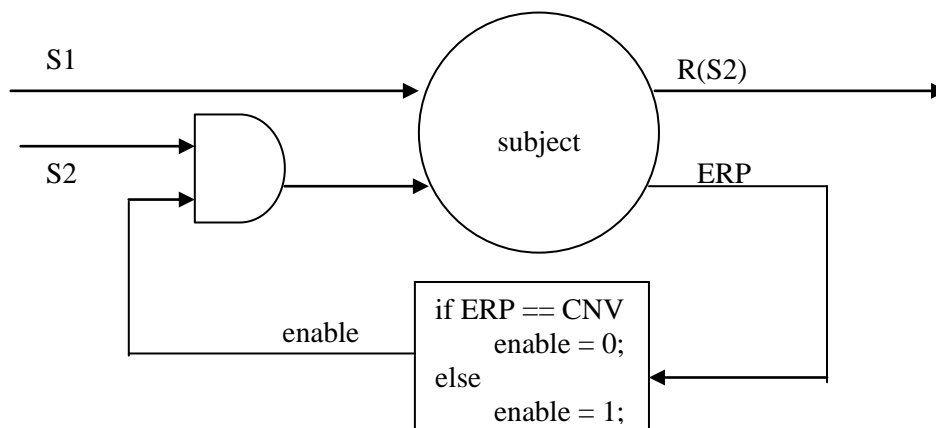

Figure 9.1. The CNV flip-flop paradigm as a BCI paradigm

It is shown that, when the ERP is recognized as a CNV, i.e. when the CNV is present,  $enable = 0$ , which leads that S2 be absent, i.e. that the subject not receive it. On the other hand, when the ERP is not recognized as a CNV, i.e. when the CNV is absent,  $enable = 1$ , which leads that the S2 be present, i.e. that the subject receive it. This way *the state of expectation controls a software device*, i.e. the appearance of the CNV leads to the disappearance of the S2 stimulus and vice versa.

## 9.2. The Challenge of Controlling a Robot

Following the contribution that BCI based on anticipatory potentials is possible, a second challenge is undertaken here, to show that with an anticipatory brain potentials based BCI one can control other external devices. In particular, in 2008 the challenge of controlling a robot using this kind of BCI was considered.

The following challenging task was considered. Solve the well-known computer science problem, the Towers of Hanoi, with a robotic arm using Anticipation based BCI. The basic idea is to use the behavior based robotics approach [Arkin, 1998]. Several robotic arm behaviors are preprogrammed, ready to be invoked by a BCI signal. The behaviors are preprogrammed in such a way that when they are called in sequence, they will solve the Towers of Hanoi problem. The robot control software receives a signal from the CNV recognition software that a CNV appeared (is ON) or decayed (is OFF). This activates one of the available behaviors from the behavior selection system.

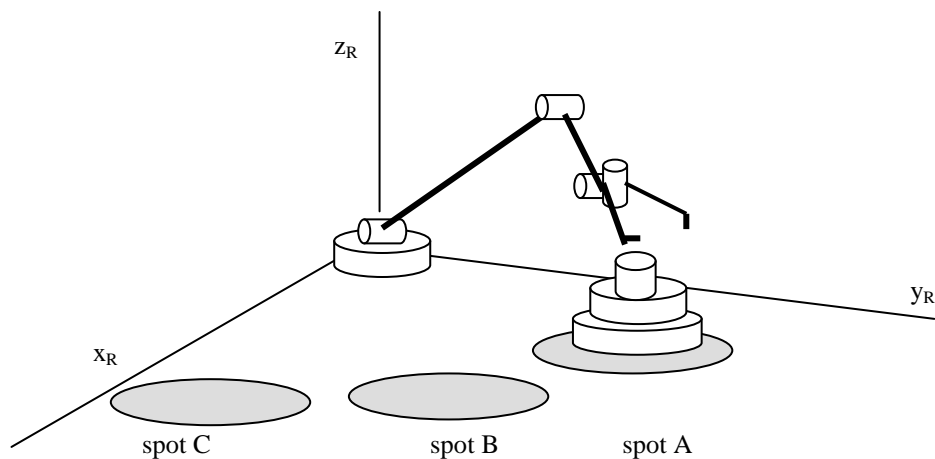

Figure 9.2. The Towers of Hanoi problem, here with three disks

### 9.3. The Towers of Hanoi Problem

The Towers of Hanoi (Figure 9.2.) is a well known puzzle in the theory of algorithms and artificial intelligence. Given a stack of disks with different diameters, a tower is defined as a stack of disks in which a smaller disk is always above a larger one. Three spots are given – A, B, and C. If the initial tower is in the spot A, move it to the spot C, using a “buffer” tower in the spot B. At each step of the task the concept of a tower is preserved, a smaller disk is always above a larger one. It is known that to move a tower of  $d$  disks,  $2^d-1$  movements of the individual disks are required.

Following is the sequence of behaviors needed for solving the TOH(2) problem (Towers of Hanoi with two disks) and the TOH(3) problem (Towers of Hanoi with three disks).

#### **TOH(2):**

Behavior 1: move from A to B

Behavior 2: move from A to C

Behavior 3: move from B to C

#### **TOH(3):**

Behavior 1: move from A to C

Behavior 2: move from A to B

Behavior 3: move from C to B

Behavior 4: move from A to C

Behavior 5: move from B to A

Behavior 6: move from B to C

Behavior 7: move from A to C

### 9.4. BCI Based on Anticipation: Algorithm for Controlling a Multi-Behavior Device

Once the Towers of Hanoi problem is decomposed to behaviors, the challenge of solving it translates into a challenge of controlling a behavior based robot. The idea is to use the property of the electroencephalogram (EXG) that it is an oscillatory curve generated by the human brain and shows an oscillation of the expectancy process during the CNV flip-flop paradigm. Events that can trigger a sequence of robot behaviors could be the appearing and disappearing of a CNV pattern in the ERP signal. Figure 9.3. shows the idea.

Figure 9.3. shows series of four robot behaviors being generated by the brain state of expectation, as observed by the computer using the EXG curve (here generated from amplitude difference as the parameter). How many behaviors can be generated in a series depends on the subject and his/her ability to adapt to the CNV flip-flop paradigm in a prolonged number of trials.

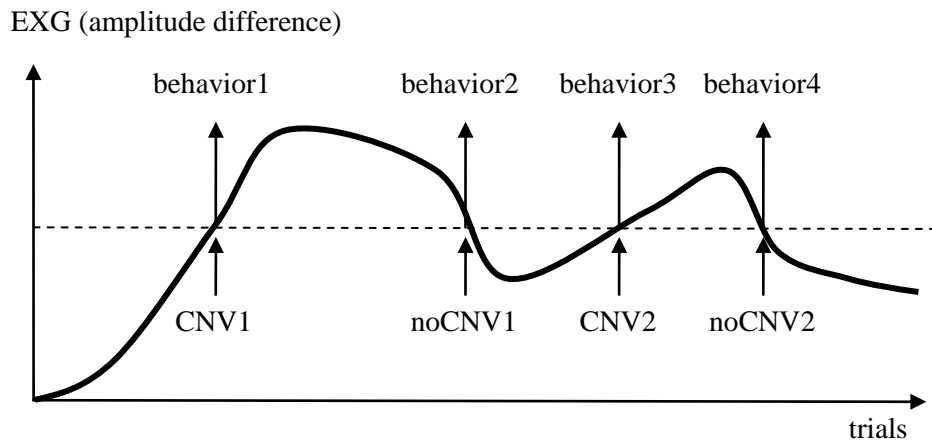

Figure 9.3. Using the electroexpectogram (EXG) to generate a series of BCI control signals

Figure 9.4. shows the logical setup of the BCI solution.  $n$  and  $u$  are counters of how many trials in a row the CNV potential has been found as present and absent, respectively. It can be seen that, for  $S2$  to be switched off, the CNV must be present 3 trials in a row, after previously being absent. Contrary, for  $S2$  to be switched back on, the CNV must be absent 2 trials in a row, after previously being present.

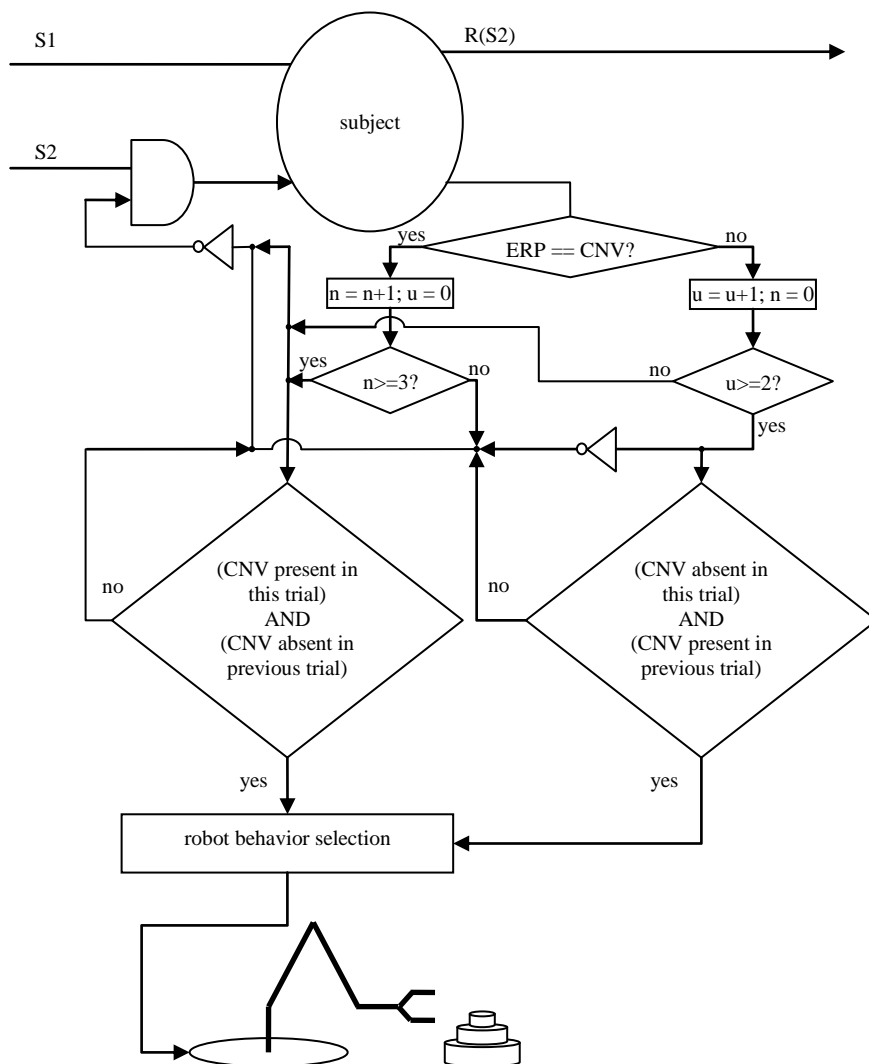

Figure 9.4. Anticipation based BCI controlling a robot arm – logical setup



## 9.5. The Experimental Setup

As described in the previous chapter, the equipment consists of a 4-channel biopotential amplifier, a PC Windows based computer, and a Lynxmotion 6-degrees-of-freedom robotic arm. The CNV flip-flop paradigm part of the software recognizes series of appearances and disappearances of the CNV potential, and triggers the behavior realization part of the software which moves the robotic arm toward the completion of the Towers of Hanoi task. The subject is connected to the biopotential amplifier with the EEG electrodes placed on Cz and mastoid, while the forehead is the ground. The experimental setup is shown on Figure 9.5.

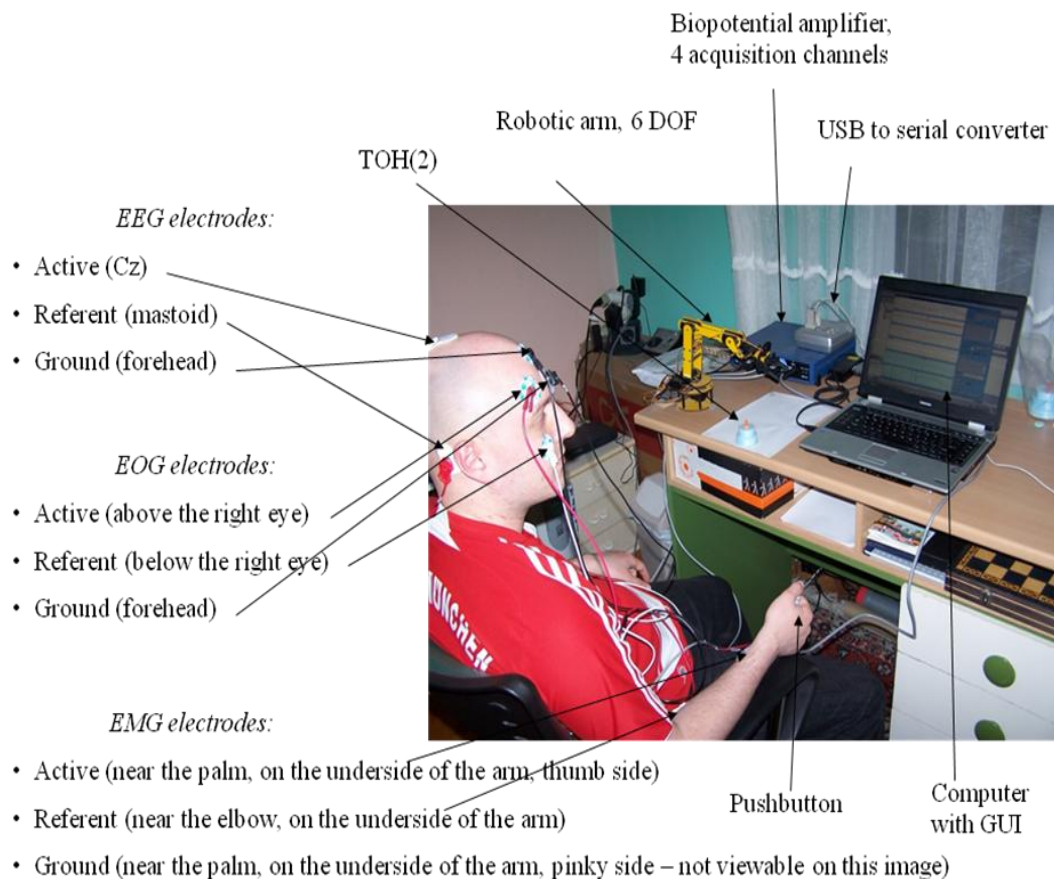

Figure 9.5. Experimental setup for a BCI solution of the Towers of Hanoi problem, using one robot

An example of an experimental trial, as observed by the experimenter, is shown in Figure 9.6. The screen shows six channels out of which the first four are acquisition channels and the last two are mathematically computed channels. The first channel is the EEG acquisition channel, the second is the EMG acquisition from the arm pressing the button, the third is the EOG signal channel, and the fourth is the press-button recognition channel. The sixth channel is the event related potential extracted so far. If an appearance or disappearance of CNV is recognized on that channel, a signal is given to the robot to move, which is recorded on channel five.

The experimental investigation described here is just a proof-of-the-concept series of experiments. Four experiments were performed on one subject different than the experimenter/programmer. A two-disk Towers of Hanoi requires three behaviors for the task to be completed, which means that the subject needs to produce a CNV1-noCNV1-CNV2 sequence in the CNV flip-flop paradigm to complete the task. Table 9.1 summarizes the experiments.

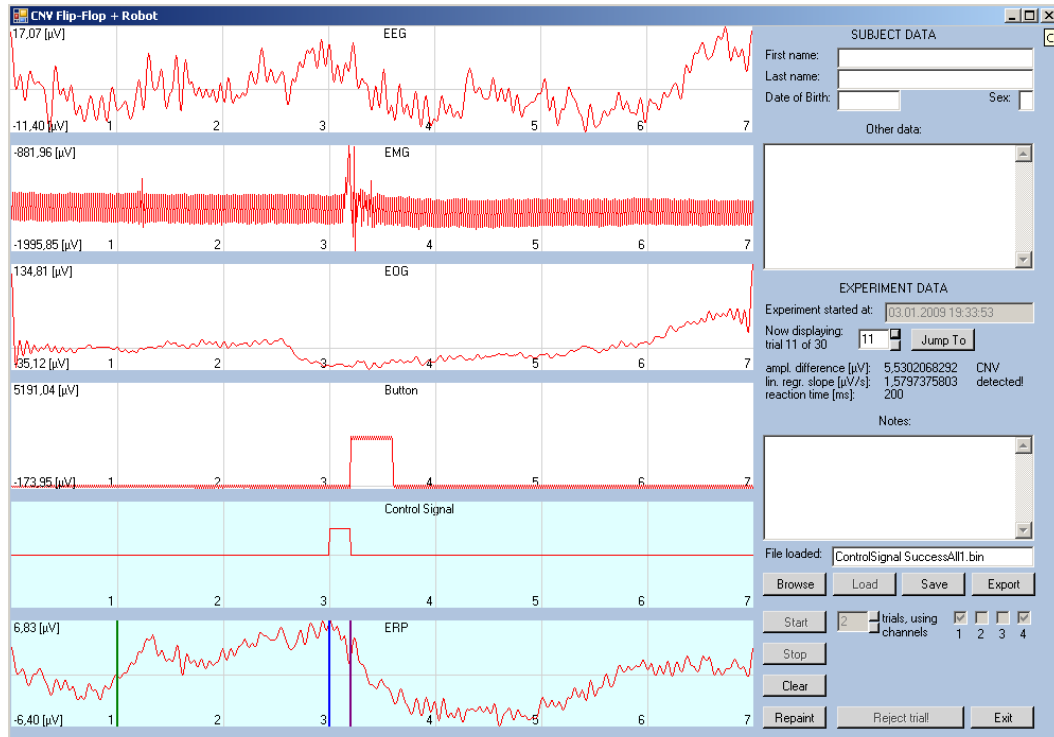

Figure 9.6. A trial of the experimental work

Table 9.1. Proof of the concept series of experiments

	Experiment			
	1	2	3	4
<b>Event → Behavior</b>	<b>Trial number</b>			
CNV1 → Behavior1	16	22	11	6
noCNV1 → Behavior2	22	23	12	19
CNV2 → Behavior3	26	29	22	22
noCNV2			29	26
CNV3				30

Each entry in Table 9.1 is the trial number in which the event occurred. For example, in the first experiment, the first appearance of CNV was in trial 16 and disappearance in trial 22 and the second CNV appearance was in trial 26. As can be seen from Table 9.1, in each experiment within 30 trials the two-disk Towers of Hanoi task was executed successfully using the Brain-Robot Interface based on anticipatory potentials.

Table 9.1 also suggests that a learning process is taking place, in which the subject in each new experiment tends to develop his/her first CNV potential earlier,

and also tends to increase the number of appearances and disappearances of a CNV potential. The series of four experiments shown in Table 9.1 were carried out with the same subject. *In all four experiments the sequence CNV1-noCNV1-CNV2 was produced which resulted in a solution of the TOH(2) problem.*

This result is one of the main contributions of this thesis. The result was presented in 2009 at an IEEE conference on Neural Engineering in a section on Brain-Computer Interface. The reviewers of the paper published in the conference proceedings [Božinovski and Božinovska, 2009] pointed out that it is a pioneering work in controlling a robot using anticipatory brain potentials.

A question arises whether the TOH(3) problem can be solved with a BCI. This is indeed possible, as will be demonstrated in the following section.

## 9.6. Control of Two Robotic Arms Using an Anticipation-Based BCI: Setup

To accomplish this, the property of the electroexpectogram, that it is an oscillating process, is again used, only this time when the EXG curve goes above the threshold, one of the robots is invoked to perform its behavior, and when it goes below the threshold, the other robot is invoked to perform its behavior. Figure 9.7. shows the events that are triggered and the respective behaviors of the corresponding robots.

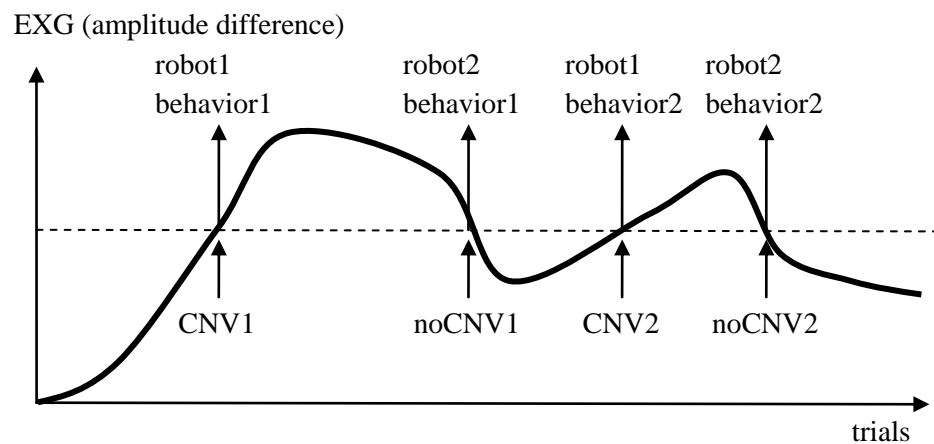

Figure 9.7. Using electroexpectogram (EXG) as a series of BCI control signals

Figure 9.8. shows the logical setup of this solution. Note that different robots are selected on different occasions, i.e. it is important whether the CNV potential has appeared in the current trial and was absent in the previous or it is the other way around. Robot1 is always invoked when the CNV appears after having been absent and Robot2 is always invoked when the CNV disappears after having been present.

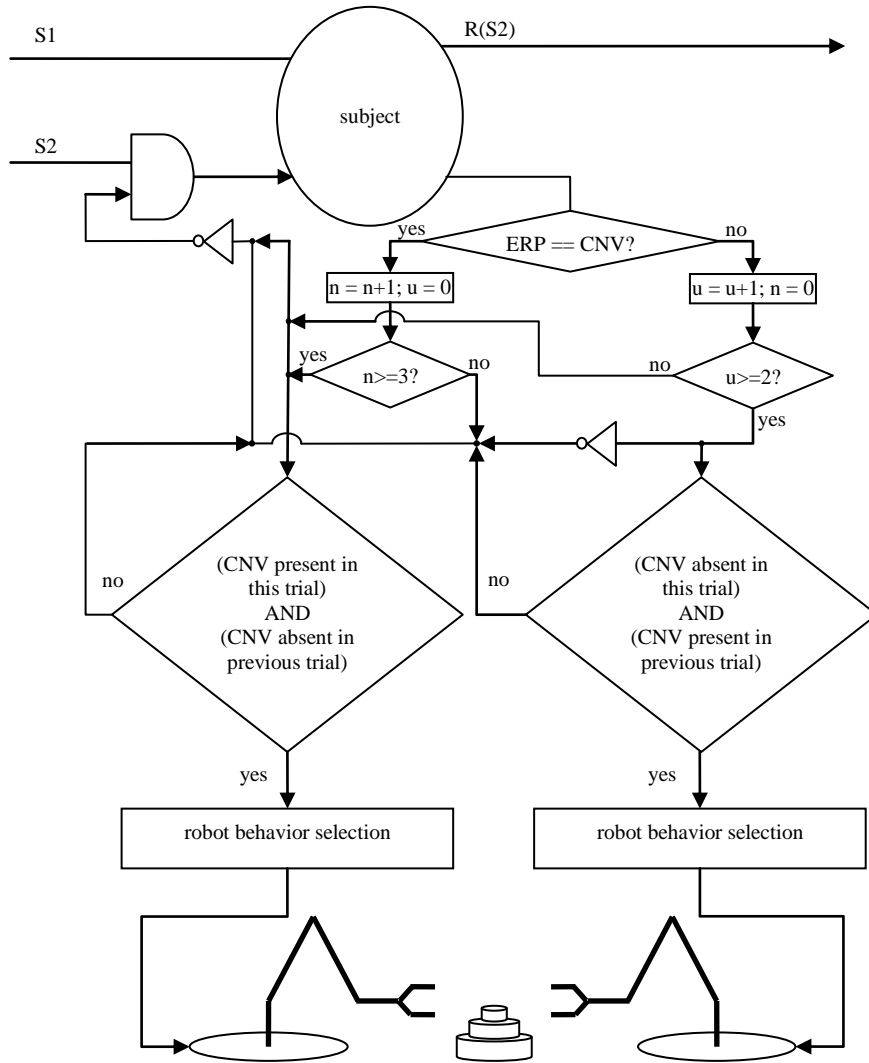

Figure 9.8. Anticipation based BCI controlling two robotic arms solving a common task – logical setup

Figure 9.9. shows a close-up display of the two collaborating robots (Lynx6 at left bottom and Lynx5 at right bottom, a 6-DOF and 5-DOF robotic arm, respectively) and the 3-disk Towers of Hanoi problem between them. Figure 9.10. shows the experimental setup, including the subject connected to the biopotential amplifier via the electrodes, the computer and the two robots in the background, having completed the 3-disk Towers of Hanoi task.



Figure 9.9. The two collaborating robotic arms solving the TOH(3) problem

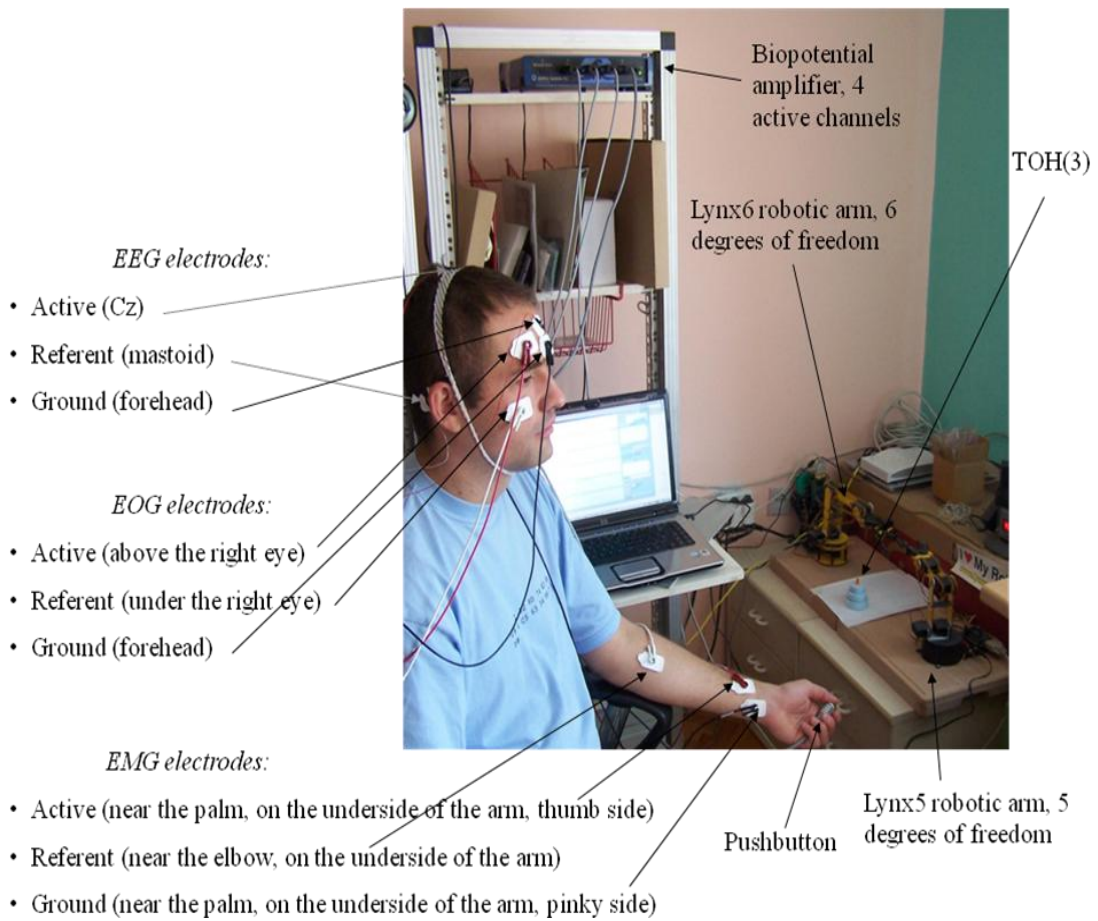

Figure 9.10. TOH(3) solution experimental setup, using two robotic arms

## 9.7. Control of Two Robotic Arms Using an Anticipation-Based BCI: Example

Here all the relevant screens of a successful CNV flip-flop experiment are given, demonstrating BCI control of two robotic arms solving the TOH(3) problem. Following are eight images, showing the first trial of a successful experiment, as well as seven trials when robot behaviors were invoked, in order to execute the respective seven disk movements of the 3-disk Towers of Hanoi problem solution. For better overview, text explanations are given beforehand, and the images follow one another.

Figure 9.11. shows the start of the experiment, i.e. the first trial. Note that the ERP is identical in form to the EEG. This is so because it is a property of the GUI to normalize the output, to fill up the channel peak-to-peak; in reality, the ERP is the EEG signal diminished by a factor of 10 (according to the time varying signal extraction algorithm proposed in Chapter 5).

Figure 9.12. shows the first appearance of a CNV. In channel 5, a control signal has been sent, and it is shown to which robot, initiating which behavior. In this case, the first robot executes its first behavior (Move from A to C).

Figure 9.13. shows the first CNV disappearance. Note that the subject did not press the button (there is no signal in the pushbutton channel) so the EMG channel shows noise, again, normalized to the entire channel. The loss of CNV is a signal for the second robot to execute its behavior, in this case its first behavior (Move from A to B).

Figure 9.14. shows that the computer recognized an appearance of CNV again, so the first robot is invoked to execute its following behavior, i.e. its second in this case (Move from B to C).

Figure 9.15. shows a subsequent CNV disappearance, and the second robot executes its second behavior (Move from A to B). Note that the EMG channel shows large artifacts in the EMG channel (likely due to arm movement), but in the “safe zone”, i.e. past the 3-second mark, when the S2 stimulus is applied. Thus, these artifacts don't corrupt the CNV oscillatory process and therefore this trial is not rejected.

Figures 9.16., 9.17. and 9.18. show the following CNV reappearance, disappearance, and reappearance, so respectively the first robot executes its third behavior (Move from B to A), the second robot executes its third behavior (Move from B to C) and the first robot executes its fourth behavior (Move from A to C), completing the task.

Thus, it took 59 trials with a subject previously participating in CNV flip-flop experiments. The experiment log is given in Figure 9.19., with an added 60<sup>th</sup> trial, to round up the experiment.

This way, it is shown that it is possible to solve the 3-disk Tower of Hanoi problem with two robots collaborating on the task, controlled by a BCI based on anticipatory brain potentials.

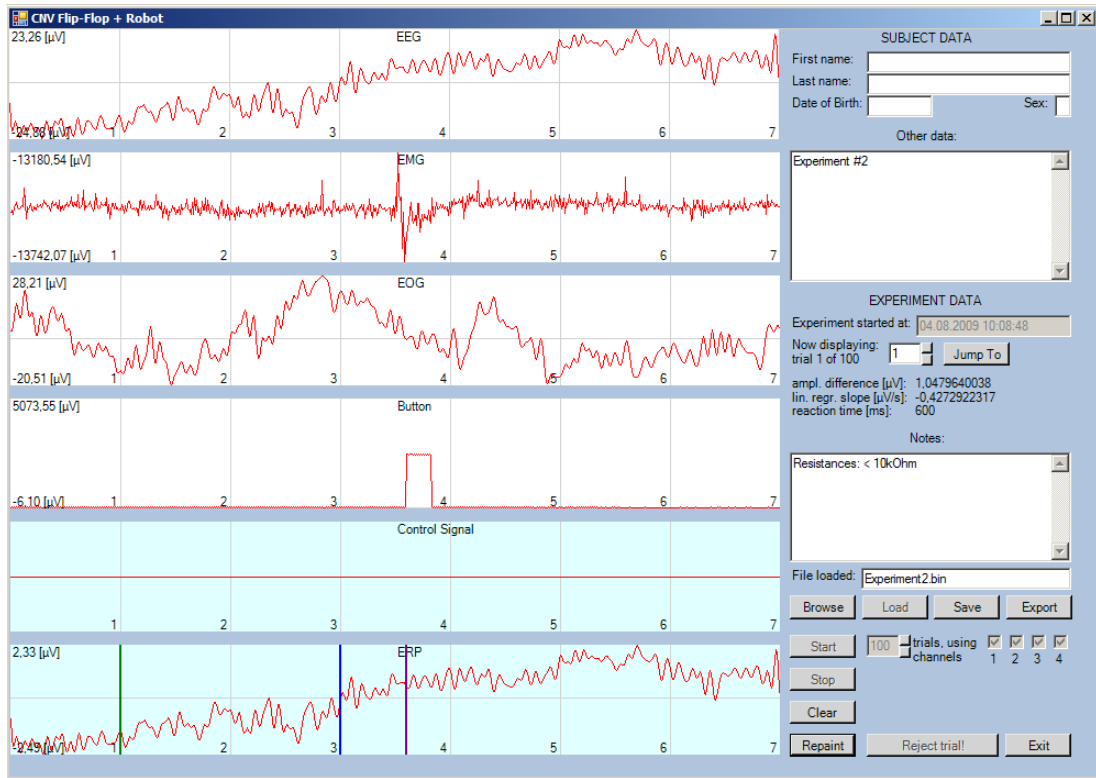

Figure 9.11. Trial 1: The experiment starts

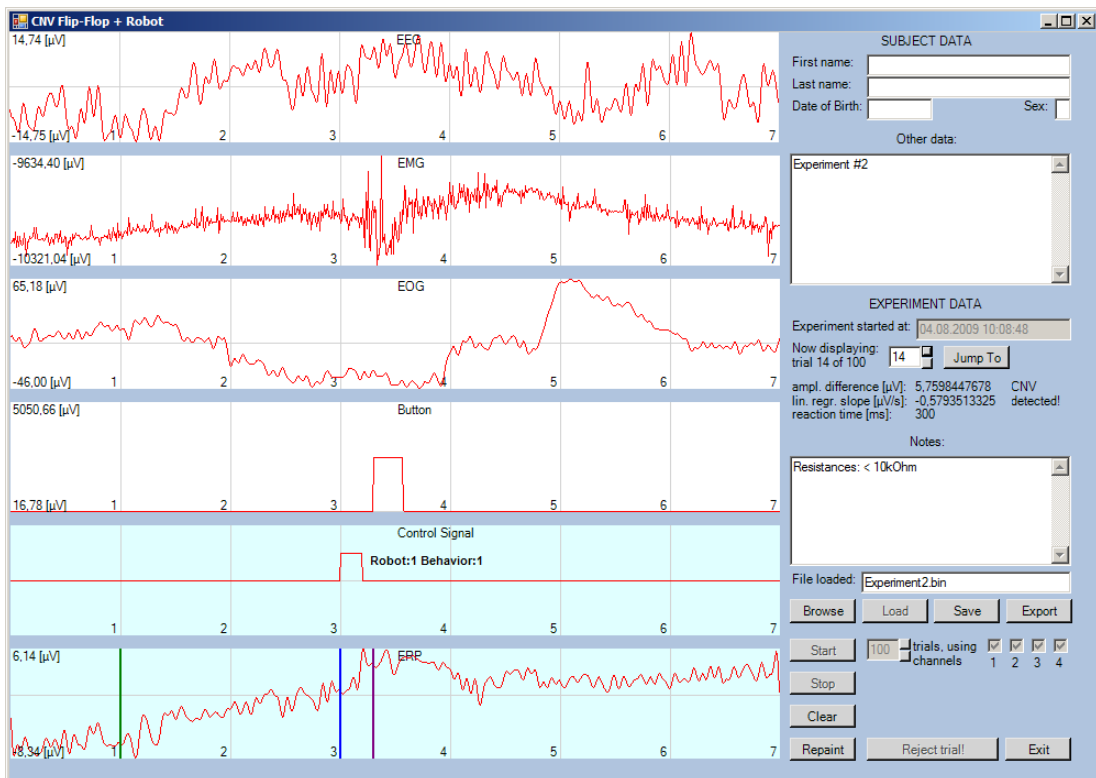

Figure 9.12. Trial 14: CNV presence detected. Robot1Behavior1 activated



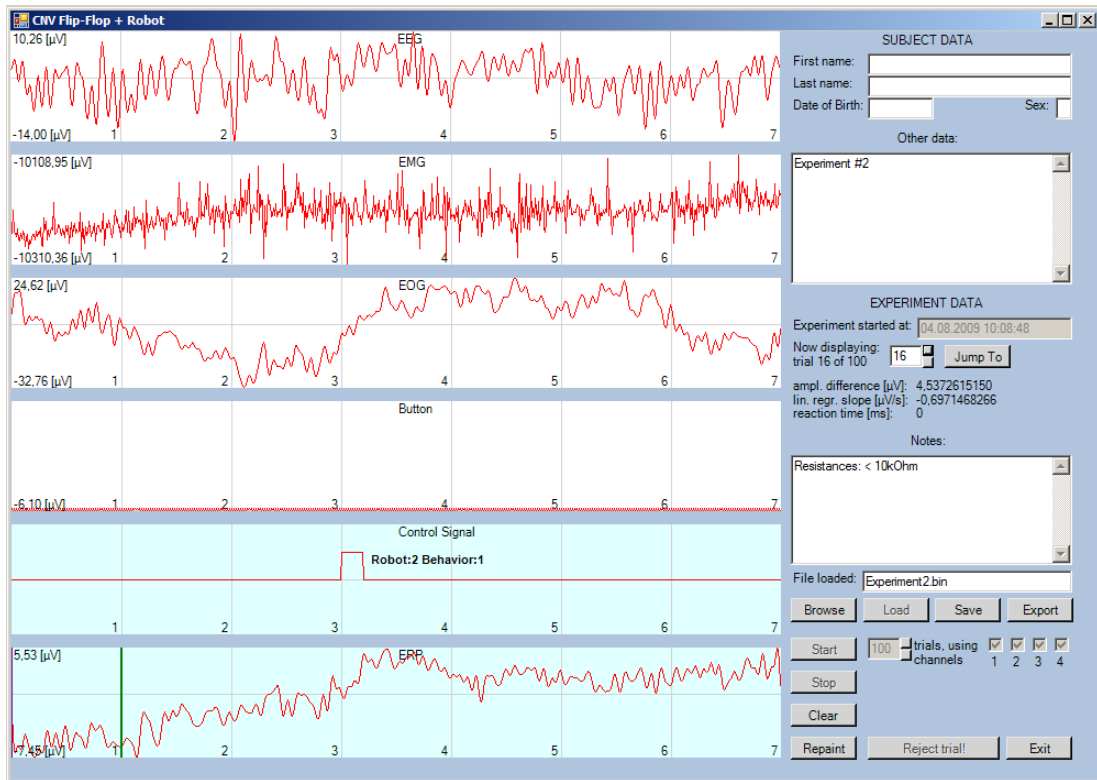

Figure 9.13. Trial 16: CNV absence detected. Robot2Behavior1 activated

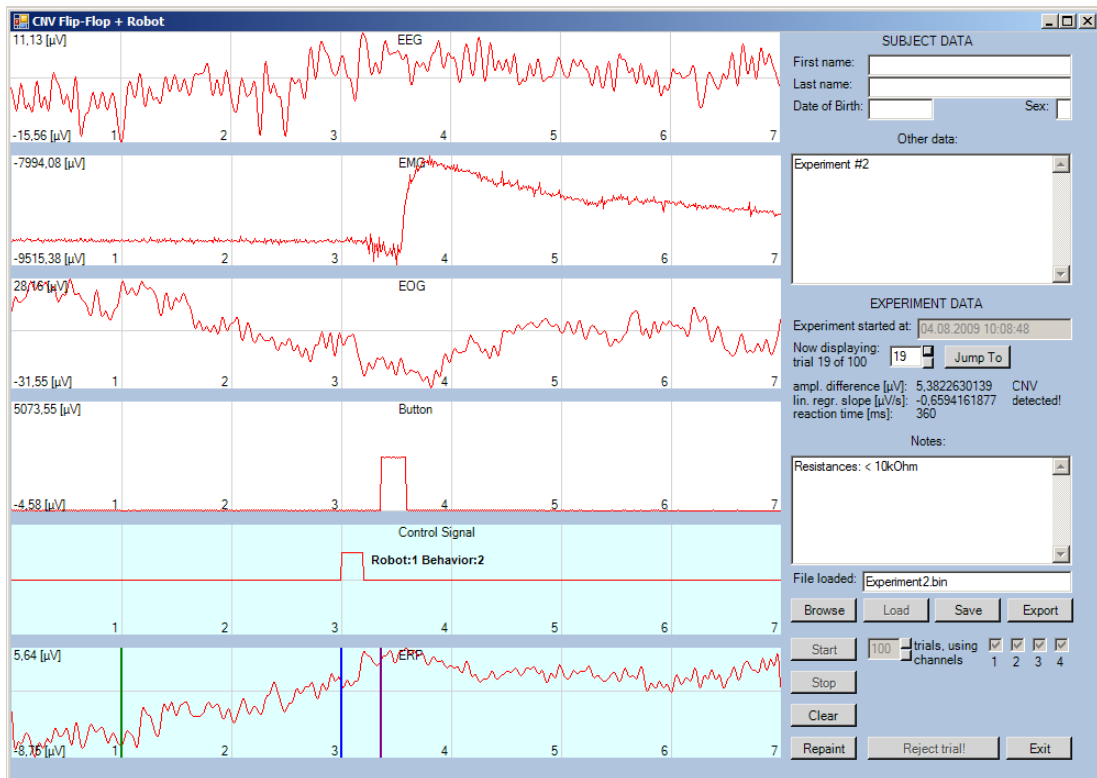

Figure 9.14. Trial 19: CNV presence detected. Robot1Behavior2 activated



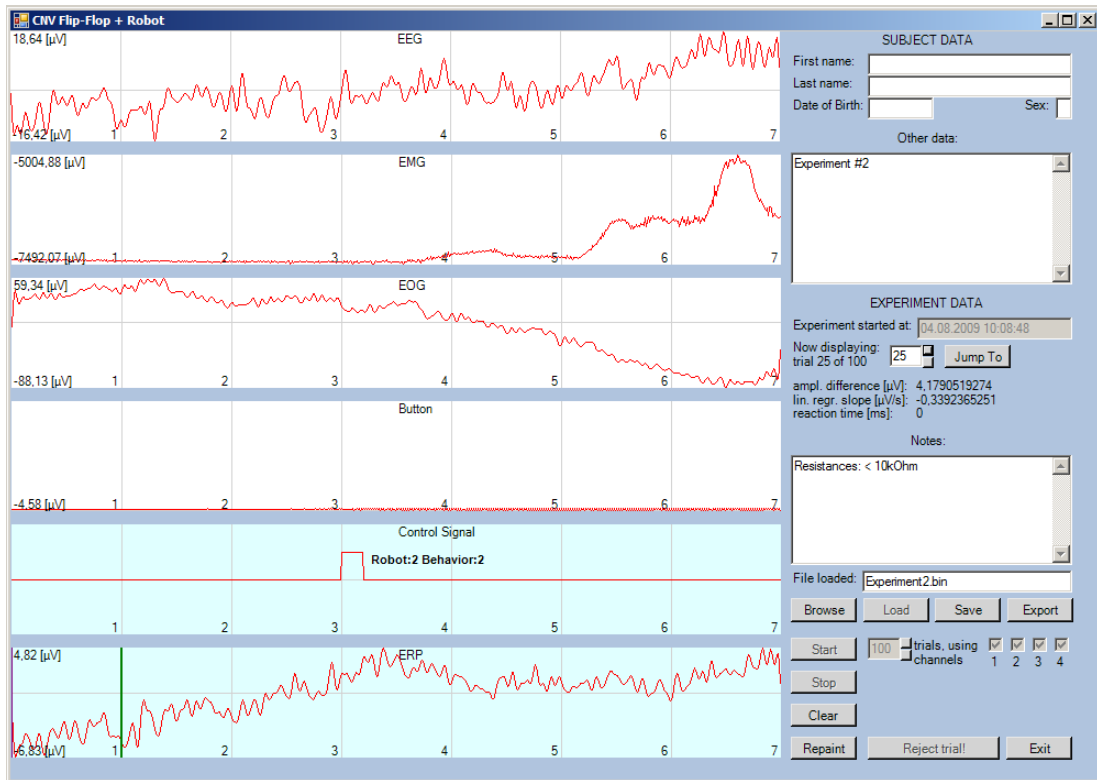

Figure 9.15. Trial 25: CNV absence detected. Robot2Behavior2 activated

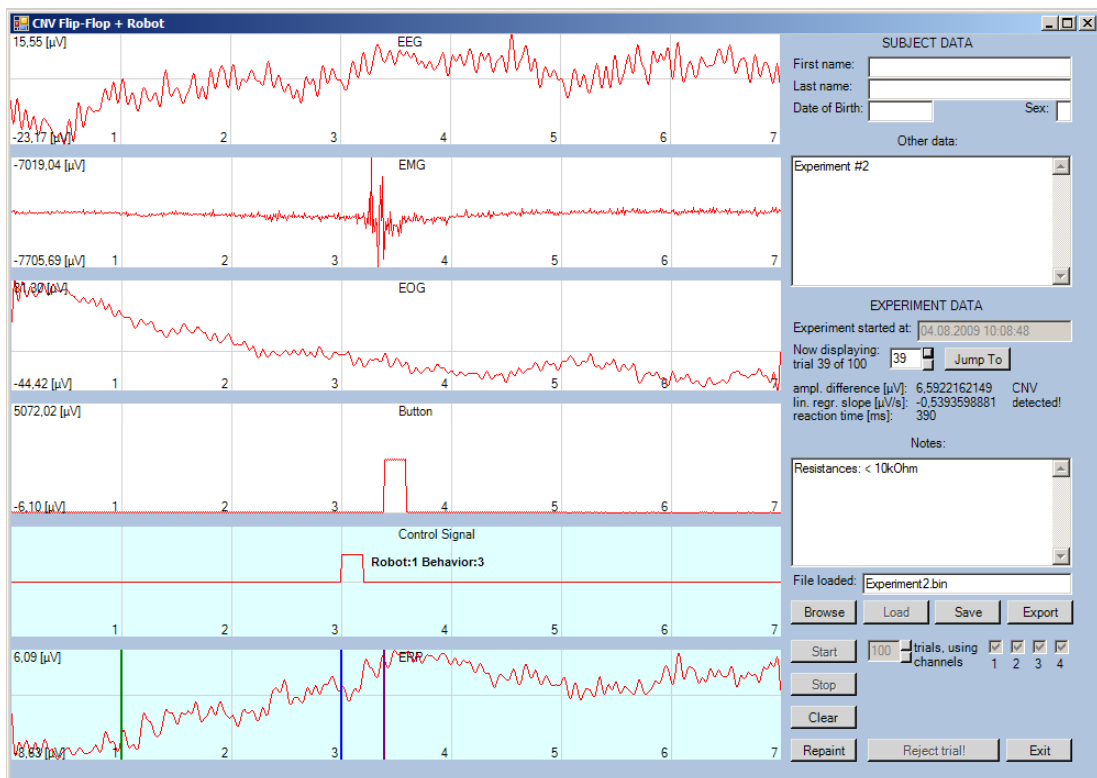

Figure 9.16. Trial 39: CNV presence detected. Robot1Behavior3 activated

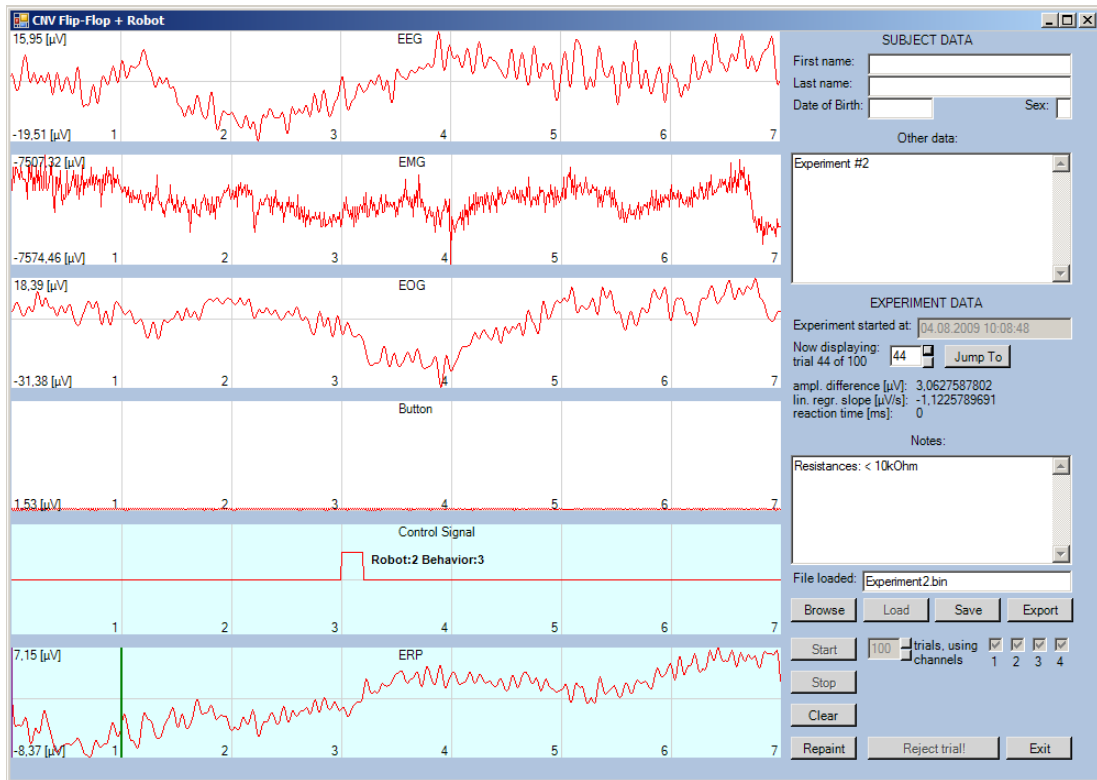

Figure 9.17. Trial 44: CNV absence detected. Robot2Behavior3 activated

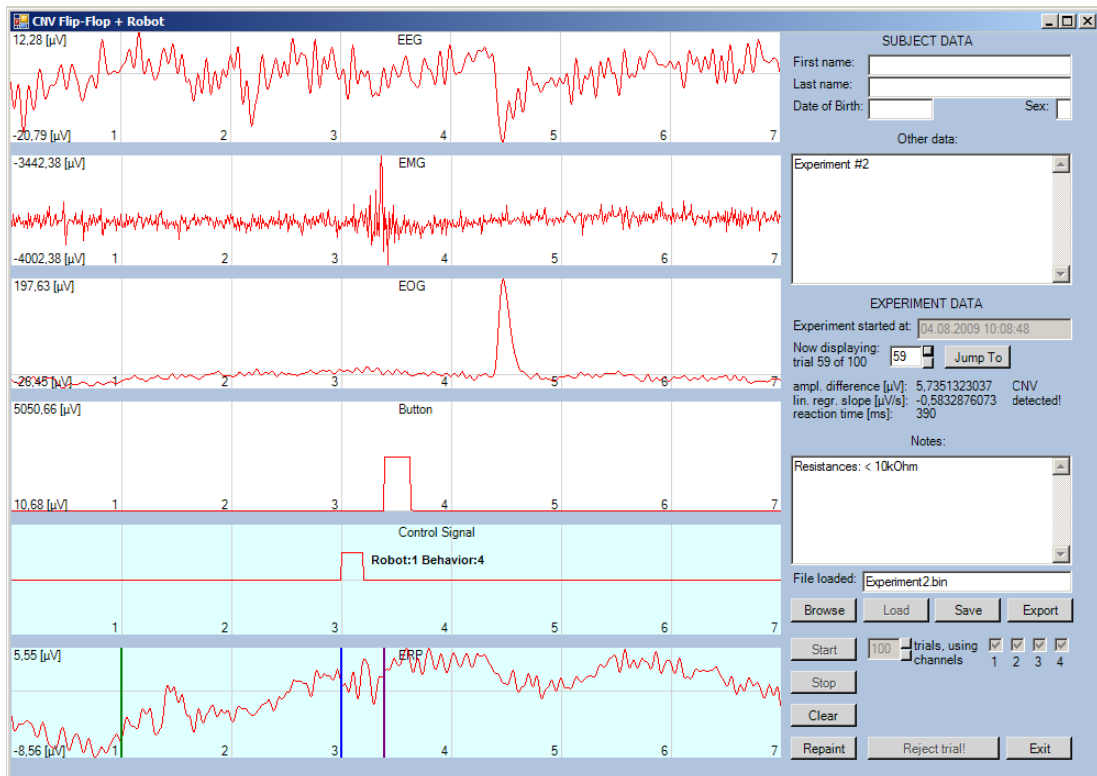

Figure 9.18. Trial 59: CNV presence detected. Robot1Behavior4 activated

RELEVANT TRIAL DATA FOR EXPERIMENT DONE ON 04.08.2009 10:08:48

Subject:                    Date of birth:                    Sex:  
Other data: Experiment #2

Recognition parameters:

Amplitude difference:     5 [ $\mu$ V]  
Linear regression slope: 3.6 [ $\mu$ V/s]

Trial	Ampl.diff[ $\mu$ V]	Rgr.slope[ $\mu$ V/s]	CNV	S2	Reac.time[ms]	Robot	Behavior
1	1,0479640038	-0,4272922317	False	True	600	n/a	n/a
2	1,8411260002	-0,5490886110	False	True	390	n/a	n/a
3	2,2596004005	-0,5729276856	False	True	350	n/a	n/a
4	3,3415762224	-0,6572719481	False	True	330	n/a	n/a
5	3,1202094781	-0,7257954109	False	True	400	n/a	n/a
6	4,5477780160	-0,7204147296	False	True	320	n/a	n/a
7	4,4406467136	-0,7307793448	False	True	340	n/a	n/a
8	3,9764451457	-0,7888757057	False	True	380	n/a	n/a
9	4,3958323701	-0,5857044597	False	True	350	n/a	n/a
10	4,3635574858	-0,4338176937	False	True	290	n/a	n/a
11	4,8140205469	-0,6067659593	False	True	310	n/a	n/a
12	5,5021454002	-0,7529786339	False	True	290	n/a	n/a
13	5,2177297645	-0,7649148965	False	True	380	n/a	n/a
14	5,7598447678	-0,5793513325	True	True	300	1	1
15	4,8966466292	-0,7711640556	True	False	n/a	n/a	n/a
16	4,5372615150	-0,6971468266	False	False	n/a	2	1
17	5,7690360328	-0,5105485650	False	True	550	n/a	n/a
18	5,5426469339	-0,6603284080	False	True	480	n/a	n/a
19	5,3822630139	-0,6594161877	True	True	360	1	2
20	6,1692445810	-0,7223460501	True	False	n/a	n/a	n/a
21	6,7633742972	-0,4305102087	True	False	n/a	n/a	n/a
22	5,7776024721	-0,5498719298	True	False	n/a	n/a	n/a
23	5,0232872594	-0,4233438253	True	False	n/a	n/a	n/a
24	4,3953835596	-0,2053363242	True	False	n/a	n/a	n/a
25	4,1790519274	-0,3392365251	False	False	n/a	2	2
26	3,5594778977	-0,5230307557	False	True	710	n/a	n/a
27	3,6860504170	-0,6446942816	False	True	430	n/a	n/a
28	4,6292372391	-0,6992757053	False	True	390	n/a	n/a
29	4,3915808343	-0,9950820989	False	True	1390	n/a	n/a
30	4,4732624659	-0,8744053815	False	True	390	n/a	n/a
31	4,5038118181	-0,8459950701	False	True	350	n/a	n/a
32	4,4793829407	-0,8683461750	False	True	440	n/a	n/a
33	4,3675884838	-0,7271725637	False	True	450	n/a	n/a
34	4,4790874093	-0,7364192131	False	True	490	n/a	n/a
35	4,8971196548	-0,6472795391	False	True	390	n/a	n/a
36	4,1048616860	-0,6241738905	False	True	820	n/a	n/a
37	5,3682958363	-0,4887858690	False	True	370	n/a	n/a
38	5,913000269	-0,5245627823	False	True	1070	n/a	n/a
39	6,5922162149	-0,5393598881	True	True	390	1	3
40	5,7075494375	-0,6031686389	True	False	n/a	n/a	n/a
41	5,3248675658	-0,7807958578	True	False	n/a	n/a	n/a
42	5,2814680733	-0,8275046338	True	False	n/a	n/a	n/a
43	4,5574795184	-0,7170438031	True	False	n/a	n/a	n/a
44	3,0627587802	-1,1225789691	False	False	n/a	2	3
45	2,6569663890	-1,1967414015	False	True	880	n/a	n/a
46	2,7258049917	-1,0894845369	False	True	410	n/a	n/a
47	3,3612137525	-1,0853422512	False	True	1220	n/a	n/a
48	3,0991312830	-1,1599201931	False	True	380	n/a	n/a
49	3,3636400129	-1,0786881769	False	True	370	n/a	n/a
50	2,5239304718	-1,1077641164	False	True	710	n/a	n/a
51	3,7215059270	-0,9517129522	False	True	420	n/a	n/a
52	3,9085921950	-0,7663147248	False	True	360	n/a	n/a
53	4,3673311248	-0,6103260666	False	True	430	n/a	n/a
54	4,0345172895	-0,6397775331	False	True	710	n/a	n/a
55	4,6815393665	-0,4670419696	False	True	410	n/a	n/a
56	4,8140081671	-0,7033954028	False	True	1410	n/a	n/a
57	5,2044434244	-0,8478657311	False	True	780	n/a	n/a
58	5,9458875563	-0,6542198031	False	True	330	n/a	n/a
59	5,7351323037	-0,5832876073	True	True	390	1	4
60	5,3825910415	-0,5215695345	True	False	n/a	n/a	n/a

Experiment notes: Resistances: < 10kOhm

Figure 9.19. Experiment log file, BCI control of two robotic arms solving TOH(3)

## 9.8. Control of Two Robotic Arms Using Anticipation-Based BCI: Statistics

Table 9.2 shows experimental results from the BCI based on anticipatory potentials, controlling 2 robots that are simultaneously solving the 3-disk Towers of Hanoi task. Shown are results from 8 experiments conducted on various subjects. Again, the trial number is written, when the corresponding event (and thus behavior) occurred in the corresponding experiment.

Table 9.2. Experiment results for 2-robot solution of TOH(3) using an anticipation-based BCI

	Experiment												Average
	1	2	3	4	5	6	7	8	9	10	11	12	
Event→Robot#Behavior#	Trial number												
CNV1→Robot1Behavior1 (A to C)	9	14	15	11	6	6	11	13	7	18	17	36	14
no CNV1→Robot2Behavior1 (A to B)	15	16	24	27	22	16	13	17	21	22	31	39	22
CNV2→Robot1Behavior2 (C to B)	22	19	29	29	25	20	21	19	25	33	36	46	27
no CNV2→Robot2Behavior2 (A to C)	31	25	48	40	35	32	24	22	41	40	42	49	36
CNV3→Robot1Behavior3 (B to A)	38	39	50	42	38	38	30	26	47	46	46	54	41
no CNV3→Robot2Behavior3 (B to C)	43	44	71	45	51	44	34	32	53	51	50	56	48
CNV4→Robot1Behavior4 (A to C)	57	59	75	47	54	46	39	39	57	59	53	68	49
FINISH	60	60	80	50	55	50	40	40	60	60	55	70	57

As can be seen, the durations of all the experiments were rounded to the nearest five (and also to the nearest ten, if the experiment ended on the five). It can be seen that on one occasion as many as 80 trials were needed to successfully complete the paradigm. However, upon averaging, it can be seen that 57 is the average number of trials at which the TOH(3) problem can be solved using the anticipation-based BCI, controlling two robots, working simultaneously.

## **Chapter 10**

### **DISCUSSION**

Discussion about the work is given in this chapter. The most important information from all the chapters is presented here.

## 10.DISCUSSION

The discovery of the computer and its development has led to its widespread use in virtually every human endeavor. The computer has become such an integral part of human life, that a research area has emerged, which deals with the ways humans interact with computers. This research area is called Human-Computer Interaction (HCI).

In human-computer interaction, a concept of an *interface* arises – a system that will interpret messages given in a form understandable to one side to a form understandable to the other side and vice versa. This way, one might consider the keyboard, the mouse, the computer screen etc, as interfaces through which the computer processor communicates messages from and to the user. These interfaces have undergone several stages of development themselves, and the current stage is the one of *electrophysiologically interactive human-computer interfaces* (EI-HCIs).

EI-HCIs are such devices in which the human output is achieved without the need of the human's external devices. The concept is challenging, since information from the subject must be gathered in a form understandable to the computer – commonly, electric signals are used from the skin, heart and so on, which can be digitized and converted to binary information. Four basic types of EI-HCI systems have been conceived: monitoring-oriented systems (where the experimenter simply gathers data from the subject and receives no feedback), biofeedback-oriented systems (where the measurements from the subject are fed back to him/her), control-oriented scenarios (where the measurements from the subjects are fed back to him/her, with a purpose of controlling a device) and hands-free control scenarios (a special type of control-oriented scenarios, where hands are not used in any way).

The type of EI-HCI discussed in this work is the *brain-computer interface* (BCI), where the signals from the subject are collected specifically from the subject's brain. Signals from the brain can be used to determine a certain brain state. Some of these states are relatively difficult to extract, i.e. determine from the brain recording alone, whereas others are obtainable through certain procedures. The latter can be used for control purposes and such states are the state of relaxation, the state of mental task, the state of imaginary movement, the state of response, and, as of recently, the state of expectation. This state is used in the experiments carried out in this work as well.

To obtain the brain state, signals from the brain must be recorded. According to the type of acquisition, BCIs can be non-invasive (where the signals are collected from the scalp, using surface electrodes), and invasive (where the signals are collected using electrodes that are implanted directly into the brain tissue). Invasive techniques are expensive and require laboratory conditions, but provide the best signal quality. Non-invasive techniques are more readily available, but offer poorer signal quality. However, because they're so widespread, they are the preferred method of signal acquisition, especially the electroencephalogram (EEG), which records electrical signals from the brain. The most commonly used system for placing EEG electrodes is the 10-20 system, which is utilized in this work as well.

In order for the acquisition to be successful, the subject and the BCI must undergo mutual training or calibration sessions, so that the subject would be prepared and/or the BCI would be set up for proper operation. In the first case (training), the subject learns to voluntarily regulate the brain activity, to obtain a desired brain state, so a certain result would be achieved. After the training activity, the subject is able to voluntarily control the parameter of interest, i.e. adapt to the machine. The other case (calibration) requires that certain parameters of the BCI be adjusted, so that the measurements would be sensible for that particular subject. In this case, it's the machine that adapts to the subject. Depending on the BCI, any one or both of these setup methods for BCI operation may be used.

Since the EEG is the preferred means of recording brain signals, it has been more extensively studied, and two basic methods for signal processing have been commonly used: extracting spectral features from the EEG signal (where certain frequencies have been found to correspond to certain brain states), and building pattern classifiers (where a brain signal is repeated several times and its features are fed into the classifier, so it would recognize future appearances if such a signal). Any one or both of these methods may be used when operating a BCI.

How successful a BCI will perform depends usually on how much information is transferred from the subject to the BCI, and also how little errors (i.e. wrong commands) the BCI executes. Lowering the error rate and executing fast mental commands are the challenges for future BCI development. Common examples of BCI control are the "thought-controlled typewriter" (which utilizes the P300 evoked potential), mobile robot control (which utilizes relaxation state), as well

as an invasive BCI, using which a robotic arm is controlled. This work presents a robotic arm control using anticipatory brain potentials.

Many brain potentials have been discovered, and they are divided into spontaneous or event-related. The event-related potentials are further divided into anticipatory and evoked. The evoked brain potentials appear after an event and can mean either that the brain reflexively reacts to the event (in which case the potential is exogenous), or that the brain has discerned the meaning of the event (in which case the potential is endogenous). Because these potentials can be controlled by controlling the event, the ease with which they are obtained had led to their early discovery and they have been extensively studied and are well known. The anticipatory brain potentials appear before an event. They are further subdivided into potentials that express readiness or preparation of the subject to react to the event (an example of such a potential being the *Bereitschaftspotential*), or expectation to the event (an example being the *Contingent Negative Variation*, i.e. CNV potential). The CNV potential is central to this work and has been discovered in 1964 by Walter and his team. The paradigm using which it has been discovered is called the CNV paradigm and consists of two stimuli, a warning one (S1) and an imperative one (S2), and the subject is instructed to react to the imperative stimulus as soon as possible. This way, after several repetitions and averaging of the obtained signals, the CNV potential appears, as a conglomerate of several evoked potentials and a negative shift in the EEG in the interval between the two applied stimuli.

The CNV potential and the CNV paradigm itself have sparked interest and several modifications have been proposed for the paradigm. The modification given in this work involves adding a feedback loop, in which the output signal is fed back to the paradigm, influencing its outcome. The presence or absence of the CNV potential determines the absence or presence of the imperative stimulus respectively. If S2 is present and CNV is absent, the reactions to S2 foster the appearance of CNV in the subject. When the CNV appears, the S2 is switched off, thus making the subject have nothing to react to. This leads to degradation of the CNV in the subject, which in turn switches the S2 back on and so on. This paradigm leads to an oscillatory process of CNV appearances and disappearances in the subject and has been named the CNV flip-flop paradigm.

The CNV flip-flop paradigm is trial-based. One trial consists of 7 seconds of acquisition, in which the first second is so-called baseline recording, where the signal is recording against which the CNV presence or absence will be determined. At the first second of recording, the S1 stimulus is applied, and at the third second the S2 stimulus is applied. The following 4 seconds of recording are used to capture the post-imperative positivity, i.e. diminishing of the CNV potential. After the trial, there are from 7 to 13 seconds of inter-trial time, where the signal is processed and the presence or absence of CNV is established. The experiments lasted while there were trials available, which was usually 100 trials.

The presence or absence of CNV is usually determined by observing one or more parameters and when the signal is such that those parameters exceed their



respective thresholds, a CNV is recognized, and not when the thresholds of the parameters are not exceeded. Such an oscillatory process can be plotted on a graph and the resulting curve is called an electroexpectogram (EXG). The oscillatory nature of the EXG (which is in turn obtained from the CNV potential) is the reason why the CNV potential is suitable for use in a BCI paradigm, in a sense that there will be times when the BCI will be active and times when not.

Because the nature of the CNV flip-flop paradigm is such that it will produce a time-varying signal, the challenge is to create algorithms that will extract such a signal and compute the parameters necessary to determine whether it is a CNV potential or not. The algorithm for extraction of the event-related potential is a neural learning algorithm, which progressively learns the current form and forgets the previous ones. Moreover, it is a part of a neural element, in which the presence or absence of the CNV potential is computed using a neural network, with the excitatory synapse is the average of the samples of the signal near the S2 stimulus, and the inhibitory synapse is the average of the samples of the signal from the beginning of recording to the S1 stimulus. If the internal potential of the neuron exceeds the threshold three trials in a row, a presence of CNV is recognized.

Even though BCI research is extensively underway, there is little standardization, in a sense that every researcher or research group develops their own software products for BCI operation. This work proposes a generic design model for BCI software, in which several modules are proposed, that each BCI software architecture should have. They are the biosignal acquisition module, the device control module, the experimental paradigm control module, the graphical user interface module and the file control module. All of these modules contain software elements, such as device drivers, program code elements etc, that enable them to function and connect with the devices used in the paradigm.

The materials and methods used in this work concern primarily the hardware and experimental procedures. The biopotential amplifier that was used is the Biopac MP35 amplifier, and electrodes used to connect to it are standard Ag/AgCl electrodes for EEG recording. EMG and EOG are also recorded, using adhesive electrodes for single use. The user's reaction is obtained through a pushbutton. The devices controlled are one or two robotic arms of the type Lynxmotion Lynx5 and/or Lynx6. The computer can be any commercially available computer, since the paradigm's demands are small, as far as working memory, processor speed, and graphics and sound card are concerned.

The robotic arms that are controlled using this paradigm are controlled using the behavior based approach. This means that the behaviors of the robots are already programmed, and are selected according to the situation. This is utilized to solve the Towers of Hanoi problem using the robotic arms, where each behavior consists of moving a disk from the tower to its appropriate spot during the realization of the problem solution. The oscillatory nature of the electroexpectogram is then used, and each crossing of the threshold is then used as a signal to invoke the appropriate behavior of the robotic arm. In the case that one robotic arm was used, an appearance

of CNV was the control signal sent to the robotic arm to invoke its appropriate behavior. In the case that two robotic arms were used, an appearance of CNV meant sending a control signal to one robotic arm, and a disappearance of CNV meant sending a control signal to the other robotic arm. Both robotic arms had their behaviors preprogrammed so as to work simultaneously on the problem.

The experimental results given in this work support proof-of-the-concept experiments, and do not represent an exhaustive population study. Rather, several experiments on a small group of subjects have been performed, and the experiments consisted of finding a solution to the problem of Towers of Hanoi with two disks using one robotic arm, as well as the problem of Towers of Hanoi with three disks, using two robotic arms, working simultaneously. The results have shown that normal subjects were generally capable of producing sufficient appearances and disappearances of the CNV potential, in order to generate the number of robot behaviors necessary to complete the corresponding Towers of Hanoi tasks.

As a summary of the discussion, it can be said that BCIs based on anticipatory brain potentials are possible and feasible. It is possible to extract time-varying event-related potentials and test them for parameters of interest, in order to obtain information about CNV appearance and disappearance in a trial-based paradigm. This knowledge and practice can be further combined with other BCI knowledge, as an addition to how anticipatory brain potentials can be used for control purposes and to give guidelines for future research in this area.

## **Chapter 11**

# **CONCLUSION**

## 11.CONCLUSION

Until 2005, the brain potentials used in BCI were: alpha waves (relaxation brain state), evoked potentials (engaged brain state recognizing patterns), beta waves (engaged brain state computational task), and mu waves (imagined motor movements). In 2005 this research started with an idea that *anticipatory brain potentials should also be used in the Brain-Computer Interface research*. This opened a new road towards BCI. This work introduced a new concept, the *CNV flip-flop paradigm*, which is an experimental and application paradigm. It is proposed that this paradigm be used as a BCI paradigm. The CNV flip-flop paradigm generates a cognitive wave, named the EXG curve, which can be used to generate series of device behaviors. In order to observe the changing state of anticipation during the CNV flip-flop paradigm, a particular problem appears, extracting a time varying event related potential (ERP) signal from the recorded EEG. In this work *proposed a neural learning algorithm that extracts the needed time varying ERP is proposed*. The whole signal-processing process in the CNV flip-flop paradigm requires also pattern recognition decisions in order to determine when the extracted ERP can be declared to have a particular CNV shape. *Special neurons are proposed, as well as a special neural network that performs both the ERP extraction and CNV recognition*. BCI systems are currently available world wide, and all of them are supported by a particular software system. Yet there is no software engineering template proposed for BCI systems. In this work *a software design model is proposed*, for a generic BCI system, as well as for an object oriented software design in particular. *The main contribution of this work is controlling a device (robot) using anticipatory brain potentials*. A BCI that controls a robotic arm is designed and it is demonstrated how a BCI can be used in solving the well known problem in Computer Science, the Towers of Hanoi. This contribution was confirmed by the

reviewers of the paper presented at an IEEE conference on neural Engineering in the section of Brain-Computer Interface. The final contribution of this paper is the *control of two devices (robots) with an anticipation based BCI*. Two robotic arms are successfully controlled, collaboratively solving the Towers of Hanoi problem, using anticipation based BCI. To the best of the author's knowledge, so far there has been no report of BCI control of two robots solving a common task.

The work presented here was carried out during the author's Master's and Doctoral study. It covers six years of research. This period also includes participation in a scientific project entitled "Electrophysiology of the Expectation and Learning Processes", as part of a bilateral scientific collaboration between Macedonia and Croatia.

The hope is that this work gives significant contribution to the area of Computer Science, in the subarea of Brain-Computer Interface. The development of electrophysiologically interactive computer interfaces will enable the creation of truly personal computers, i.e. systems that read and understand their users' signatory brain potentials. That will improve human interaction with devices, as well as help us learn more about our psychophysiological selves. Combining computing with physiological sensing technologies will transform human machine interaction and foster in a wide range of new applications.

## REFERENCES

- Abel J. S., A divide and conquer approach to least-squares estimation, *IEEE Transactions on Aerospace and Electronic Systems*, vol. 26, no. 2: pp. 423–427, March 1990
- Adry P. R., Dempster M. A. H., Introduction to Optimisation Methods. Chapman and Hall Ltd, London, 1974
- Allanson J., Electrophysiologically Interactive Computer Systems *IEEE Computer*: pp. 60-65, March 2002
- Amai W., Fahrenholtz J., Leger C., Hands-Free Operation of a Small Mobile Robot, *Autonomous robots 11*: pp. 69-76, 2001
- Arkin R., Behavior-Based Robotics, The MIT Press, 1998
- Artamenko D., Role of hippocampal neurons in theta wave generation. *Neurpofiziologiya 4*: pp. 531-539, 1972
- Austin J. H., Zen-Brain Reflections, The MIT Press, 1 edition, 2006
- Berger H., Über das Elektrenkephalogramm des Menschen, *Arch. Psychiat. Nervenkr.* vol 87: pp. 527-570, 1929
- Biopac Systems Inc., Biopac Student Laboratory Manual, 1998-2003
- Božinovska L., Išgum V., Barac B., Electrophysiological and Phenomenological Evidence of the Expectation Process in the Reaction Time Measurements, *Iugoslavica Physiologica et Pharmacologica Acta*, Vol 21, 1985
- Božinovska L., Sestakov M., Stojanovski G., Božinovski S., CNV potentials intensity change during biofeedback training carried by a personal computer (In Croatian) *Neurologia*, Suppl. 2, Vol 37: p. 76, 1988
- Božinovska L., Božinovski S., Stojanov G., Electroexpectogram: Experimental Design and Algorithms, Proc. IEEE International Biomedical Engineering Days, Istanbul: pp. 58-60, 1992
- Božinovski A., CNV Flip-flop as a Brain-Computer Interface Paradigm, Proc 7th Conference of the Croatian Association of Medical Informatics, Rijeka: pp. 149-154, 2005
- Božinovski A., Božinovska L., Tonković S.: A Brain-Computer Interface: Expectancy Potentials, Proc. of 2nd Balkan Conference in Informatics, Ohrid: pp. 283-289, 2005
- Božinovski A., Control Software for the Towers of Hanoi Problem Solving Using Manipulative Robot – A Case Study, Proceedings of the Second Balkan Conference in Informatics, Ohrid: pp. 366-378, 2005

Božinovski A., Božinovska L., Tonković S., A Cognitive Wave from a Human Brain in a Brain-Computer Interface Paradigm, Proc. 10th International Conference on Cognitive and Neural Systems, Boston: p. 102, 2006

Božinovski A., Božinovska L., Tonković S.: A CNV Anticipatory Potential Related Brain-Computer Interface, Proc. 11th International Conference on Cognitive And Neural Systems, Boston: p. 43, 2007

Božinovski A., Božinovska L., Tonković S.: Electrophysiologically Interactive Human-Machine Interfaces, Proc. of the 6th International Conference on Informatics and Information Technology (ed. Lj. Antovski, M. Mihova), Molika, Bitola: pp. 48-50, 2008

Božinovski A.: Human-Computer Interfaces and Anticipatory Brain Potentials, FER, Zagreb, Croatia, 2008

Božinovski A., Božinovska L.: Anticipatory Brain Potentials in a Brain-Robot Interface Paradigm, 4th International IEEE EMBS Conference on Neural Engineering, Antalya, Turkey: pp. 451-454, 2009

Bozinovski S., Sestakov M., Bozinovska L., Using EEG Alpha Rhythm to Control a Mobile Robot, Proc 10th Annual Conference of the IEEE Engineering in Medicine and Biology Society, New Orleans, Vol 3: pp. 1515-1516, 1988

Bozinovski S., Mobile Robot Trajectory Control: From Fixed Rails to Direct Bioelectric Control, in O. Kaynak (Ed.) Proc IEEE International Workshop on Intelligent Motion Control, Istanbul, vol 2: pp. 463-467, 1990

Brave S., Nass C., Emotion in human computer interaction. In J. Jacko, A. Sears (eds.), The Human-computer Interaction Book. Lawrence Erlbaum Associates: pp. 81-96, 2003

Carmena J.M., Lebedev M.A., Crist R.E., O'Doherty J.E., Santucci D.M., Dimitrov D.F., Patil P.G., Henriquez C.S., Nicolelis M.A.L., Learning to control a brain-machine interface for reaching and grasping by primates. PLoS Biology, 1: pp. 193-208, 2003

Cilliers P. J., Van Der Kouwe A. J. W., A VEP-Based Computer Interface for C2-Quadriplegics, Proc. of the 15<sup>th</sup> Annual International Conference of the IEEE: p. 1263, 1993

Craig A., Kirkup L., McIsaak P., Searle A., The Mind as a Reliable Switch: Challenges of Rapidly Controlling Devices Without Prior Learning, in S. Howard, J. Hammond., G. Lindgaard (eds.) Human Computer Interaction, Chapman and Hall: pp. 4-10, 1997

Chapin J. K., Moxon K. A., Markowitz R. S., Nicolelis M. A. L., Real-Time Control of a Robot Arm Using Simultaneously Recorded Neurons in the Motor Cortex, Nature Neuroscience., vol. 2: pp. 664-670, 1999

Deecke L., Kornhuber H.H., An electrical sign of participation of the mesial "supplementary" motor cortex in human voluntary finger movement, Brain Res. 159: pp. 473-476, 1978

- Deecke L., Kornhuber H.H., Human freedom, reasoned will, and the brain. The Bereitschaftspotential story. In: Jahnshahi M., Hallett M. (eds.) The Bereitschaftspotential, movement-related cortical potentials, Kluwer Academic – Plenum Publishers: pp. 283-320, 2003
- Donchin E., A multivariate approach to the analysis of average evoked potentials. *IEEE Trans Biomedical Engineering*, 13: pp. 131-139, 1966
- Donchin E. *Cognitive Psychophysiology, Event-Related Potentials and the Study of Cognition*, the Carmel Conferences, Volume 1, Lawrence Erlbaum, August 1, 1984
- Donchin E., Johnson R., Sequential Expectancies, Decision Making and P300, *Psychophysiology*, vol. 19, No. 2, 1982
- Donchin E., Spencer K., Wijesinghe R., The Mental Prosthesis: Assessing the Speed of a P300-Based Brain-Computer Interface, *IEEE Trans. Rehab. Eng.* 8: pp. 174-179, 2000
- Farwell L., Donchin E., Talking off the top of your head: Toward a mental prosthesis utilizing brain potentials, *Electroencephal. Clin. Neurophysiol.* 70: pp. 510-523, 1988
- Ferrez P., Millan J. de R. Error-related EEG potentials generated during simulated brain-computer interaction. *IEEE Trans Biomed Eng*, 55(3): pp. 923-929, 2008
- Galan F. Nuttin M., Lew E., Ferrez P., Vanacker G., Phillips J., Millán J. de R., A brain-actuated wheelchair : Asynchronous and non-invasive brain-computer interfaces for continuous control of robots. *Clinical Neurophysiology* 119: pp. 2159-2168, 2008
- Gangadhar G., Chavarriaga R., and Millán J. d. R., “Recognition of anticipatory behavior from human EEG,” in 4th Intl. Brain-Computer Interface Workshop and Training Course: pp. 128–133, 2008
- Georgopoulos A.P., Lurito J.T., Petrides M., Schwartz A.B., Massey J.T., Mental rotation of the neuronal population vector. *Science* 243: pp. 234-236, 1989
- Gilden J., Vaughan H., Costa L., Summated human EEG potentials with voluntary movement. *Electroencephalography and Clinical neurophysiology* 20: pp. 433-438, 1966
- Guyton A.C., Hall J.E., *Textbook of Medical Physiology*, W.B. Saunders Company, 11<sup>th</sup> edition, 2006
- Haardt M. and Markus E.A., Unitary ESPRIT: How to exploit additional information inherent in the rotational invariance structure, in *Proceedings of the IEEE International Conference on Acoustics, Speech, and Signal Processing*, vol. 4: pp. IV229–IV232, 1994
- Heckhausen H., Perspektiven einer Psychologie des Wollens, in Heckhausen H. et al (eds.), *Jenseits des Rubikon: Der Wille in den Humanwissenschaften*, Springer, Berlin: pp. 121-142, 1987



- Huckabee M.L., Deecke L., Cannito M.P., Gould H.J., Mayr W., Cortical Control Mechanisms in Volitional Swallowing: the Bereitschaftspotential, *Brait Topogr.* 16: pp. 3-17, 2003
- Jacko J., Sears A. (eds.), *The Human-computer Interaction Book*. Lawrence Erlbaum Associates, 2003
- Jung T.-P., Makeig S., Westerfield M., Townsend J., Courchesne E., Sejnowski T. J., Analysis and Visualization of Single-Trial Event-Related Potentials, *Human Brain Mapping* 14: pp. 166-185, Wiley-Liss Inc., 2001
- Keirn Z., Aunon J., A new mode of communication between men and his surroundings, *IEEE Trans. Biomed. Eng.* vol 37: pp. 1209-1214, 1990
- Kerkhof G., Event related potentials and auditory signal detection: Their diurnal variation for morning-type and evening-type subjects. *Psychophysiology* 19: pp. 94-103, 1982
- Kohlmorgen J. and Blankertz B., Bayesian classification of single-trial event-related potentials in EEG. *Int. J. Bif. Chaos*, 14(2): pp. 719–726, 2004
- Kolb B., Whishaw I.Q. *Fundamentals of Human Neuropsychology*, W. H. Freeman, New York, 1996
- Kornhuber H.H., Deecke L., Hirnpotentialänderungen beim Menschen vor und nach Willkürbewegungen, dargestellt mit Magnetbandspeicherung und Rückwärtsanalyse, *Pflügers Arch. Eur. J. Physiol.* 281:52, 1964
- Kornhuber H., Deecke L., Hirnpotentialänderungen bei Willkürbewegungen und passiven Bewegungen des Menschen: Bereitschaftspotential und reiferente Potentiale, *Pflügers Arch.* 284: pp.1-17, 1965
- Lebedev M.A., Carmena J.M., O’Doherty J.E., Zacksenhouse M., Henriquez C.S., Principe J.C., Nicolelis M.A.L., Cortical ensemble adaptation to represent actuators controlled by a brain machine interface. *J. Neurosci.* 25: pp. 4681-4693, 2005
- Lubenov E., Siapas A., Hippocampal theta oscillations are traveling waves. *Nature* 459: pp. 534-539, 2009
- Luck S., *An Introduction to the Event related potential technique*. The MIT Press, 2005
- Mason S., Birch G., A Brain-Controlled Switch for Asynchronous Control Applications, *IEEE Trans. Biomedical Engineering* 47 (10): pp. 1297-1307, 2000
- McCulloch, W. and Pitts, W., A logical calculus of the ideas immanent in nervous activity. *Bulletin of Mathematical Biophysics*, 7: pp. 115 – 133, 1943
- McFarland D., Lefkowitz A., and Wolpaw J., Design and operation of an EEG-based brain-computer interface with digital signal-processing technology, *Behav. Res. Meth. Instrum. Comput* vol 29: pp. 337-345, 1997

- Millán J. de R., Renkens F., Mourino J., Gerstner W., Non-invasive brain-actuated control of a mobile robot by human EEG. *IEEE Trans Biomedical Engineering*, 51(6): pp. 1026-1066, 2004
- Millán J. de R., Buttfield A., Vidaure C., Krauledat M., Schloegl A., Shenoy P., Blankertz B., Rao R., Cabeza R., Pfurtscheller G., Mueller K-R. Adaptation in Brain-Computer Interfaces. In Dornhege G., Millán J. de R., Hinterberger T., McFarland D., Mueller K. (eds) *Towards Brain-Computer Interfacing* Cambridge, MIT Press, 2007
- Nicolelis M., Chapin J., Controlling Robots with the Mind. *Scientific American*, October, 2002
- Nielsen J. *Usability Engineering*: Academic Press, Boston, MA, 1993
- Ortiz S. Brain-Computer Interfaces: Where human and machine meet *IEEE Computer*: pp. 17-21, January 2007
- Osaka M., Peak alpha frequency of EEG during mental task: Task difficulty and hemispheric differences, *Psychophysiology*, 21: pp. 101-105, 1984
- Pfurtscheller G., Flotzinger D., and Kalcher J., Brain-computer interface – A new communication device for for handicapped persons, *J. Microcomput. Appl.*, vol 16: pp. 293-299, 1993
- Pfurtscheller G., Neuper C., Schlogl A., and Lugger K., Separability of EEG signals recorded during right and left motor imagery using adaptive autoregressive parameters, *IEEE Trans. rehab. Eng.* 6: pp. 316-325, 1998
- Pfurtscheller G., Neuper C. “Motor imagery and direct brain-computer communication” *Proc. IEEE* vol 89: pp. 1123-1134, 2001
- Picton T., Lins O., Scherg M. The recording and analysis of event-related potentials. In F. Boller and J. Grafman (eds.) *Handbook of Neurophysiology Vol 10* , Baltimore, Elsevier Science: pp 3-73,1995
- Pregenzer M., Pfurtscheller G., Frequency component selection for an EEG-based brain to computer interface, *IEEE trans. rehab. Eng.* 7: pp. 413-417, 1999
- Proctor R., Vu K-P., Human Information Processing: An Overview for Human-Computer Interaction, in J. Jacko, A. Sears (eds.) *The Human-computer Interaction Book*. Lawrence Erlbaum Associates: pp. 35-51, 2003
- Ritter W., Ford J., Gaillard A., Harter R., Kutas M., Naatanen R., Polach J., Renault B., Rohrbaugh J. Cognition and event related potentials. In R. Karrer, J. Kohen, P. Tueting (eds.) *Brain and Information: Event-related potentials*. New York Academy of Sciences, p. 24-38, 1984
- Rohrbaugh J., Gaillard A., Sensory and motor aspects of the contingent negative variation In A. Gaillard, W. Ritter (eds.) *Tutorials in event related potentials research: Endogenous components*, Amsterdam, North Holland, 1983
- Sanei S., Chambers J., *EEG Signal Processing*, Wiley-Interscience, 2007

Schmidt E.M., McIntosh J.S., Durelli L., Bak M.J., Fine control of operantly conditioned firing patterns of cortical neurons, *Experimental neurology*, Sep;61(2): pp. 349-69, 1978

Searle A., Electrode performance and signal processing strategies for the discrimination of EEG alpha waves: Implications for environmental control by unconstrained subjects without training. PhD Thesis, Dept of Applied Physics, University of Technology, Sydney, 2000

Sellers E., Krusienski D., McFarland T., Vaughan T., Wolpaw J., A P300 Event-Related Potential Brain-Computer Interface (BCI): The Effects of Matrix Size and Inter-Stimulus Interval on Performance, *Biological Psychology* 73(3): pp. 242-252, 2006

Sharp H., Rogers Y., and Preece J.: *Interaction Design: Beyond Human Computer Interaction* 2nd ed. John Wiley and Sons, New York, NY, 2007

Shneiderman B. and Plaisant C.: *Designing the User Interface: Strategies for Effective Human-Computer Interaction* 4th ed. Addison-Wesley, Reading, MA, 2004

Soernmo L., Laguna P., *Bioelectrical Signal Processing in Cardiac and Neurological Applications*. Elsevier Academic Press, 2005

Stanley G. B., Li F. F., and Dan Y., Reconstruction of natural scenes from ensemble responses in the LGN, *J. Neurosci.*, 19(18): pp. 8036-8042, 1999

Sutton S., Tueting P., Zubin J., John E., Information delivery and the sensory evoked potential. *Science* 155: pp. 1436-1439, 1967

Sutton S., Ruchin D., The late positive complex. In R. Karreer, J. Kohen, P. Tueting (eds.) *Brain and Information: Event-Related Potentials*. The New York Academy of Sciences: pp. 1-23, 1984

Tecce J., Cattanach L., "Contingent Negative Variation (CNV)," in E. Niedermeyer and F. Lopes da Silva (eds.) *Electroencephalography: Basic Principles, Clinical Applications and Related Fields* (3<sup>rd</sup> ed.) Williams and Wilkins: pp. 887-910, 1993

Vidal J., "Toward Direct Brain-Computer Communication," *Annual Review of Biophysics and Bioengineering*: pp. 157-180, 1973

Walter G., Cooper R., Aldridge V., McCallum W., "Contingent Negative Variation: An Electric Sign of Sensory-Motor Association and Expectancy in the Human Brain," *Nature*, 1964

Wang C., Guan C., Zhang H., P300 Brain-Computer Interface Design for Communication and Control Applications, *Proceedings of the IEEE Engineering in Medicine and Biology 27th Annual Conference*, Shanghai, China, September 1-4, 2005

Wessberg J., Stambaugh C.R., Kralik J.D., Beck P.D., Laubach M., Chapin J.K., Kim J., Biggs S.J., Srinivasan M.A., Nicolelis M.A., Real-time prediction of hand trajectory by ensembles of cortical neurons in primates, *Nature* 16: pp. 361-365, 2000

Wickelgren I., "Tapping the Mind," Science vol. 299: pp. 496-499, 2003

Wolpaw J., Farland D., Neat G., Forneris C., An EEG-based brain-computer interface for cursor control Electroenceph. Clin. Neurophys., vol. 78: pp. 252-259, 1991

Yoshikawa K., Modelling Humans in Human – Computer Interaction, in J. Jacko, A. Sears (eds.) The Human-computer Interaction Book. Lawrence Erlbaum Associates: pp. 118-146, 2003

## INTERNET REFERENCES

- [1] <http://upload.wikimedia.org/wikipedia/en/5/54/MouseBCI.jpg> (last accessed on October 18, 2009)
- [2] [http://upload.wikimedia.org/wikipedia/en/4/49/LGN\\_Cat\\_Vison\\_Recording.jpg](http://upload.wikimedia.org/wikipedia/en/4/49/LGN_Cat_Vison_Recording.jpg) (last accessed on October 18, 2009)
- [3] <http://upload.wikimedia.org/wikipedia/commons/8/8c/BCI.jpg> (last accessed on October 18, 2009)
- [4] <http://www.electropsychology.com/brainmap.gif> (last accessed on October 24, 2009)
- [5] <http://upload.wikimedia.org/wikipedia/en/a/ac/ComponentsofERP.svg> (last accessed on October 24, 2009)
- [6] <http://www.brown.edu/Research/Memlab/py47/diagrams/Luria-brain.jpg> (last accessed on October 18, 2009)
- [7] [http://upload.wikimedia.org/wikipedia/commons/7/7d/Bereitschaftspotenzial\\_fig1.jpg](http://upload.wikimedia.org/wikipedia/commons/7/7d/Bereitschaftspotenzial_fig1.jpg) (last accessed on October 18, 2009)
- [8] <http://bfbgames.org/articles/images/add01.gif> (last accessed on October 24, 2009)

## **APPENDIX A: SOFTWARE SPECIFICS OF THE BCI BASED ON ANTICIPATORY BRAIN POTENTIALS**

This appendix is meant to give a more in-depth view into the software solution for the BCI presented in this work. The software contains more than 3500 lines of code, and explaining it fully would require a paper on its own, so here only the principles of its operation will be described.

## **APPENDIX A:**

### **SOFTWARE SPECIFICS OF THE BCI BASED ON ANTICIPATORY BRAIN POTENTIALS**

The software was developed in the C# language, using the .NET 2.0 environment. The development was enhanced by using the SharpDevelop code editor.

#### **A.1. The Software Design**

In this work, the paradigm setup, shown on Figure A.1., was used (this figure has been previously shown as Figure 6.1., but it is repeated here for clarity). As can be seen, the subject's mental state is first acquired (through signal acquisition and its conversion to digital form), and then the signal is pre-processed (i.e. channel-wise structured and filtered), the ERP (event-related potential) is extracted, i.e. isolated from other signals which are not of interest, and then the desired mental state is recognized (in this case, the CNV potential) as present or absent. The next step is the application interface, i.e. the GUI (graphical user interface) to the user (in this case experimenter), at which moment the experimenter may affect the course of the experiment, by rejecting the current trial, if he/she decides to do so. The next step is the robot control, when an appropriate signal is sent to the robot (or robots), if the conditions are met (i.e. if the CNV potential has appeared or disappeared, in this case). All of this takes place in one trial of the experiment.

However, even though Figure A.1. explains the paradigm generically, Figure A.2. (first shown in the text as Figure 7.1.) gives a more software-oriented structure of the paradigm. Not surprisingly, because it shows the generic structure of a BCI design model, which is followed by the software solution for the BCI based on

anticipatory potentials, developed for the purposes of this work. In fact, it was that same software structure, which yielded that this generic BCI design model be proposed.

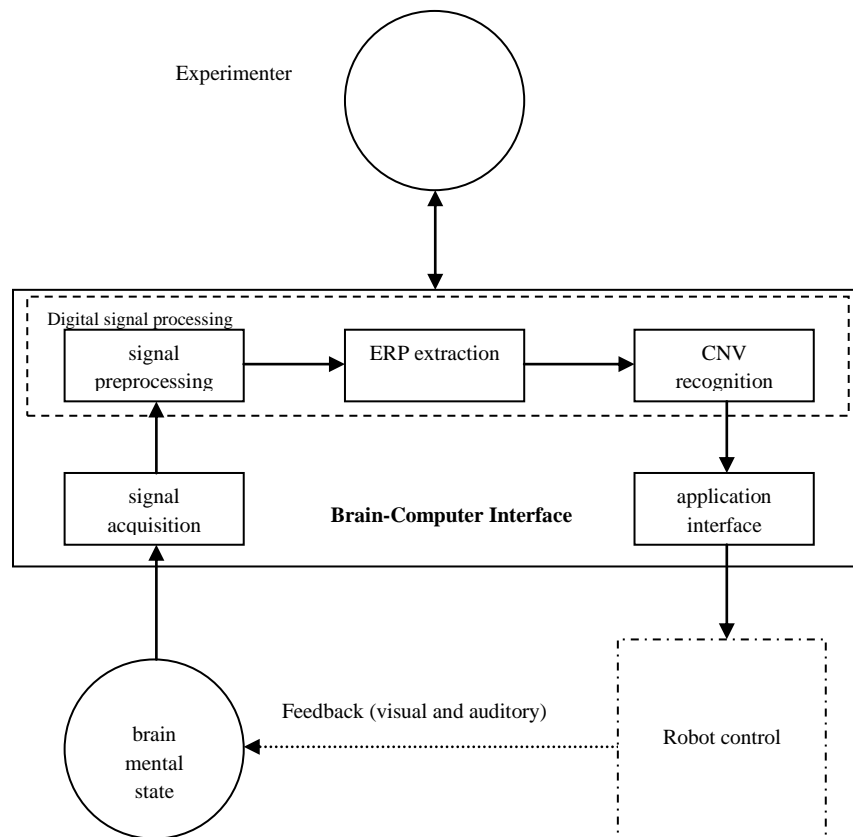

Figure A.1. The BCI paradigm used in this research

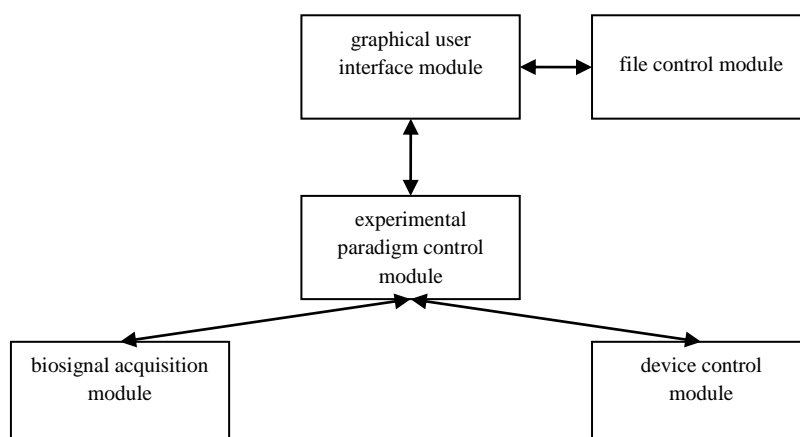

Figure A.2. A generic BCI design model



## A.2. The Parts of the BCI Structure

The structure of the software and hardware parts, that form the complete BCI, are shown on Figure A.3. (this figure was shown in the text as Figure 7.2. but is repeated here for clarity). It displays the complete structure, including all the namespaces, classes, interfaces, as well as hardware devices used in the solution. The methods and objects used are omitted.

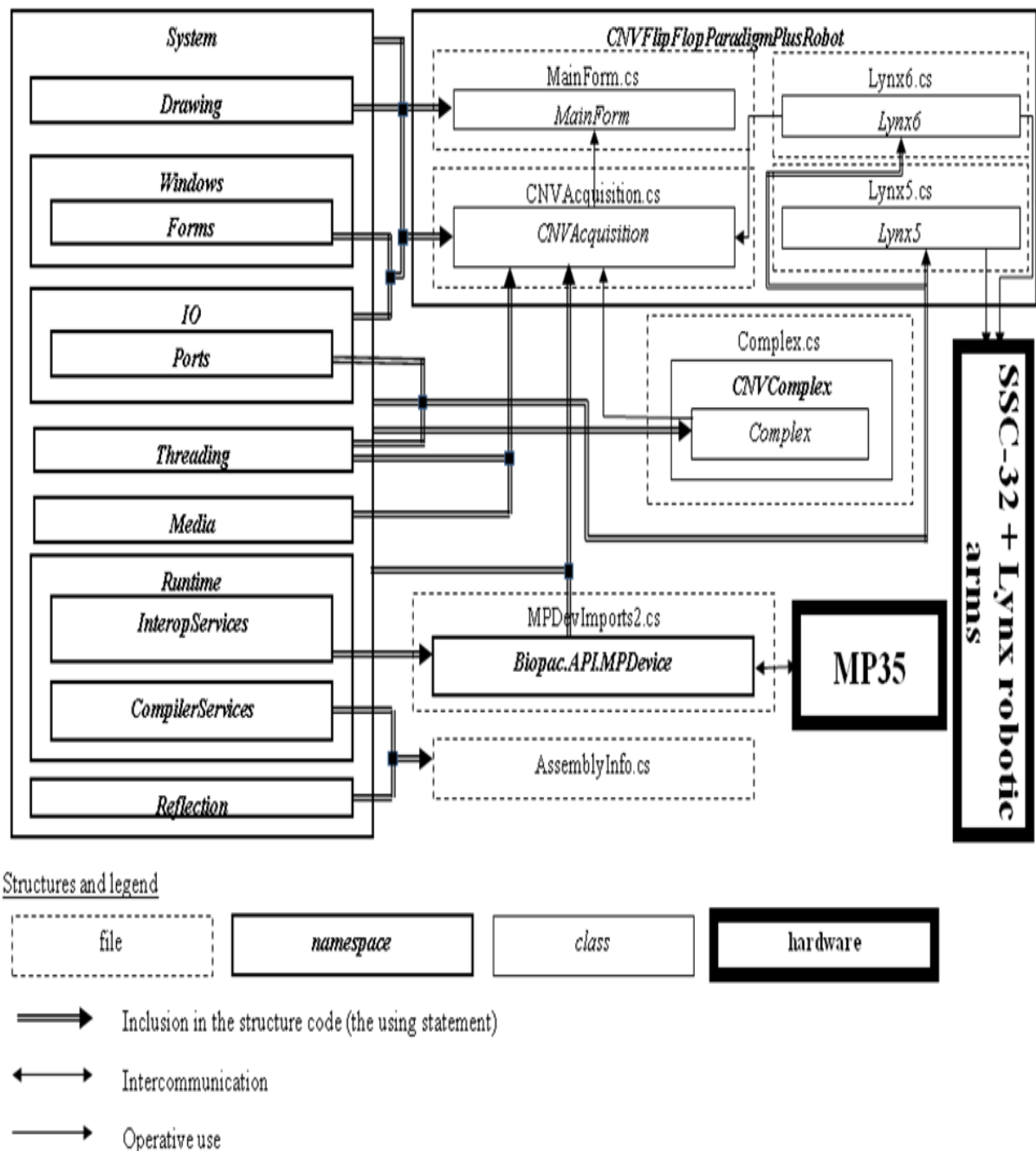

Figure A.3. The structure of the BCI implementation in this work

The modules of the BCI design model in this structure are shown on Figure A.4. (in the text shown as Figure 7.3., but repeated here for clarity). In this case, the GUI module and file control module are set in the same class, mainly because the file manipulation operations are relatively simple and straightforward, so they can be incorporated inside another module. And, since the file manipulation operations are performed by clicking buttons, which are a part of the GUI module, it made sense to combine both of these modules in a single class.

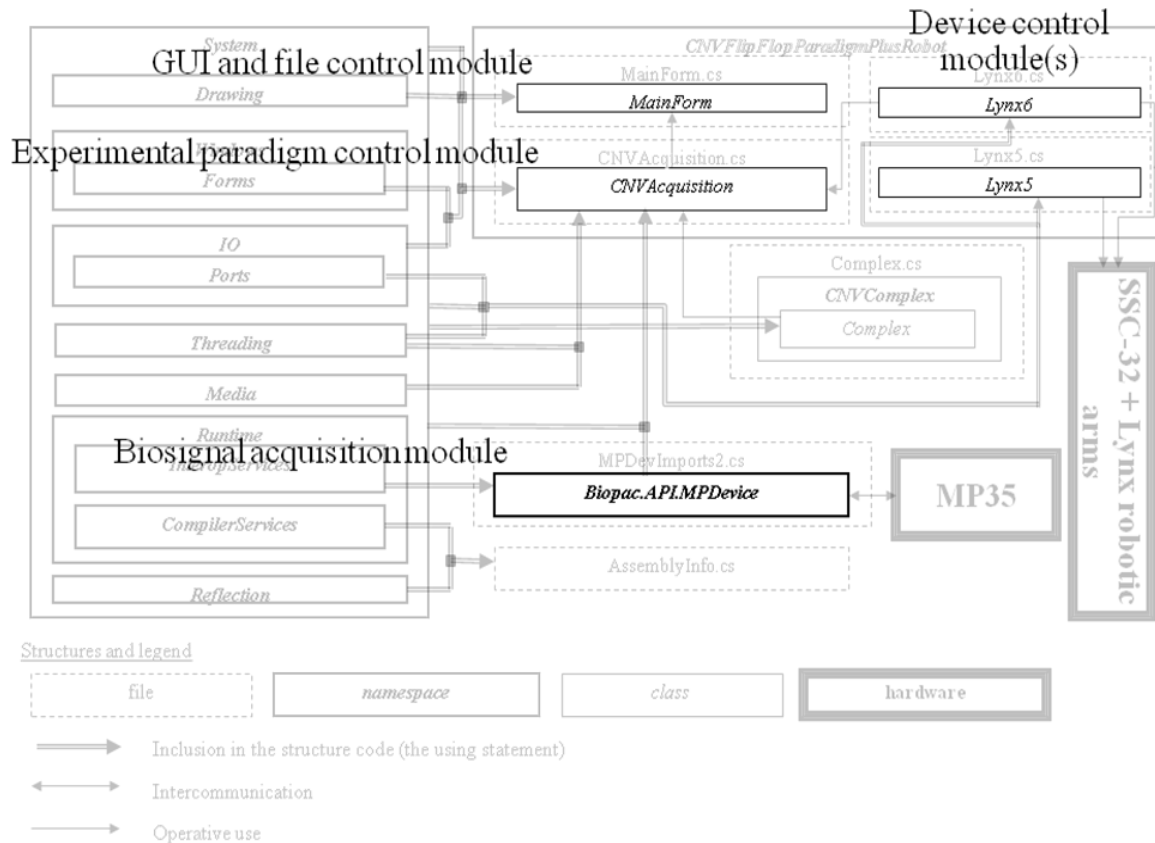

Figure A.4. The BCI modules used in the implementation

The following sections will explain the most important parts of the software solution, as well as their functions, in greater detail. The order of precedence will be given according to the parts that the user encounters during the realization of the paradigm.

### A.3. The Graphical User Interface: Experiment Start

Figure A.5. shows the screen immediately after the start of the program. The dominant figures on the screen are the 6 data windows, of which the top 4 are reserved for so-called “raw” data, and the bottom 2 are for data that are obtained upon computation. At right, from top to bottom, there are the data about the subject (first name, last name, date of birth and sex), below them are the data concerning the experiment (the moment of experiment start, the current trial observed, as well as the

trial-dependent data), followed by a “Notes:” text box, where the experimenter may enter notes during the entire course of the experiment. Below are the file manipulation GUI parts, such as the file name text box and file manipulation buttons. Control buttons are at the very bottom right of the screen, using which an experiment can be started, stopped, cleared from memory, or the screen repainted, if necessary. Also, a Reject Trial button is given, as a means of the experimenter’s control of the paradigm. An Exit button is also given.

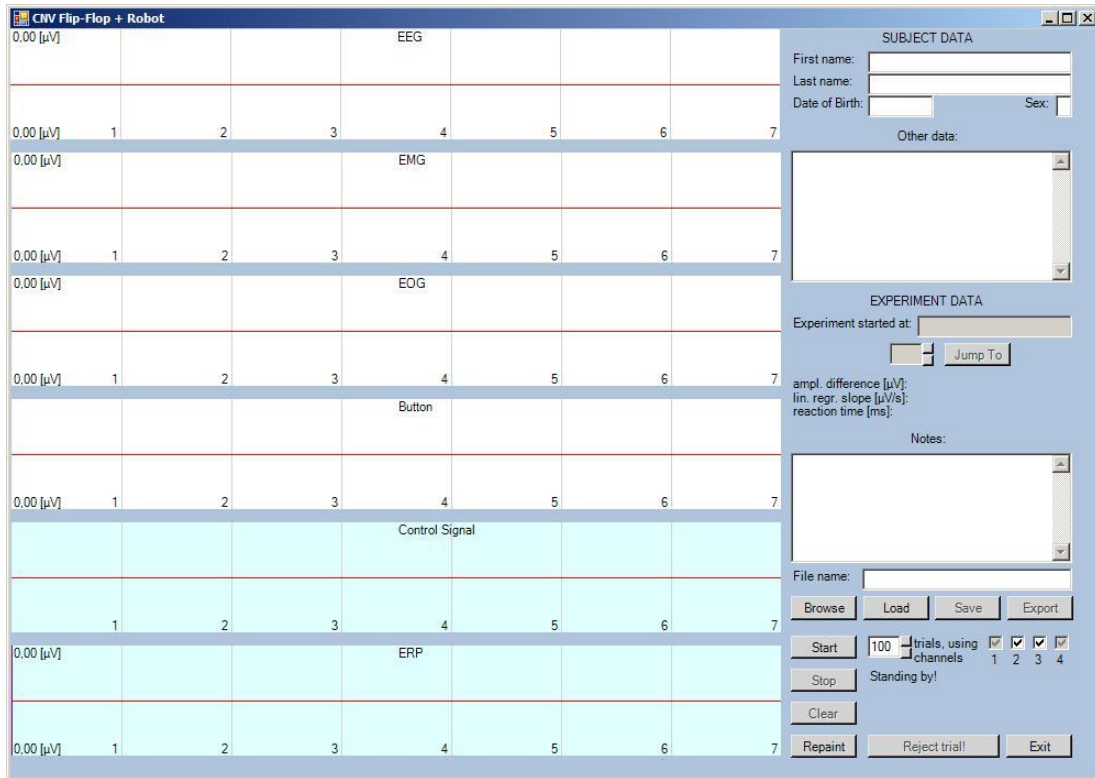

Figure A.5. The initial screen of the software, before an experiment begins

The initial number of trials is 100, which can be seen at the bottom right of the screen. Initially, the 4 CheckBoxes at the right of the number of trials selector are all checked, whereas CheckBoxes numbered 1 and 4 are also disabled. This is to make certain that channel 1 (EEG) and channel 4 (Button) can never be disabled, because they the CNV flip-flop paradigm depends on data obtained through them, whereas channels 2 (EMG) and 3 (EOG) are not of key importance to the paradigm and are useful only as hints to the experimenter, and can be disabled, if desired.

At the moment of pressing the Start button, several things happen. First, the number of trials in the experiment is read from the number of trials selector (the default value is 100). A 3-dimensional array of `double` (i.e. double precision floating point) values is created, which will contain every sample in every channel in every trial. The first dimension is the channel number, the second dimension is the sample number, and the third dimension is the trial in question. Since the acquisition frequency is 100 Hz, and there are 7 seconds of acquisition, there will be 700 samples per channel per trial. The reason that `double` values are used is that the MP35 biopotential amplifier returns the results of acquisition in `double` values, and

since hardware limitations are not an issue, working with high-precision values is beneficial. Initially, all of these values are set to zero.

Another array that gets initialized is the one that holds the sample numbers at which the trial-specific “lines” are to be drawn on the screen. These “lines” represent the three paradigm-determining moments, which are the moment of applying the warning stimulus (S1), the imperative stimulus (S2) and the user’s reaction (RT, i.e. reaction time). Thus, this is a two-dimensional array, with the first dimension being the “line” in question and the second – the trial number. Since all of these values are positive integers, the `uint` (i.e. unsigned integer) value type is used. Again, initially, all of these values are set to zero.

The third array that gets initialized is a one-dimensional array of `TrialData` elements. `TrialData` is a custom-created `struct` compound type, consisting of several variables, that are trial-dependent, and which hold the values of:

- the amplitude difference of the signal, which will be used to calculate the presence or absence of the CNV potential (a `double` value);
- the slope of the signal, again useful for calculating the presence or absence of the CNV potential (a `double` value);
- the reaction time of the subject, shown as a sample number (a `uint` value);
- a flag, showing whether the CNV potential has been recognized in the trial or not (a `bool`, i.e. Boolean value);
- another flag, showing whether the S2 stimulus should be present in the trial or not (a `bool` value);
- the number of the robot that is to be moved, as a result of the BCI’s operation (a `uint` value);
- the behavior of the robot that is to be moved, as a result of the BCI’s operation (a `uint` value);

Since these values are trial-dependent, this array has as many of these elements as there are trials in the experiment.

Another array that gets initialized is one that holds the ERP (event-related potential) signal of a previous trial. This is useful if a rejection of the trial occurs, and the previous ERP signal needs to be restored. Thus, this is a one-dimensional array and contains 700 samples, i.e. `double` values.

All of these elements are a part of the `MainForm` class, which contains the GUI module of the software, because they are needed for graphical data display. This process will be given more attention in a subsequent section, following the order of operation of the software.

## A.4. The Acquisition Process and Data Decimation

The complete process of data processing is carried out in the `CNVAcquisition` class, i.e. by the object of that class that is instantiated within the `MainForm` class. The first part of the data processing is the data acquisition, specifically the conversion of the signal from analog to digital.

The `MPDevImports` class communicates with the MP35 biopotential amplifier. This class communicates with the MP35's device driver library, using its methods for connection, channel set-up, acquisition, etc.

Initially, a connection with the MP35 must be established. This is followed by setting up of the sample rate, which in our case is 100 Hz. Next, the acquisition channels are set up, passed as an array of `bool` values (this is why the channels are designed as `CheckBoxes`, which can be switched on or off, as shown on Figure A.5. – obtaining an array of values from them is straightforward).

The next activity is the acquisition itself. It is actually realized asynchronously, since a software server is set up between the MP35 and the computer, which can draw data out of the MP35 whenever programmed to do so (which is the essence of the MP35's programmability).

The data are drawn in a form of an array of `double` values, which contains as many elements as there are active channels, i.e. it contains one sample per channel. This means that the data acquisition must be set up in such a way, that a loop is performed, which will collect as many samples as needed, in order to collect a sufficient amount of samples for the duration of the acquisition. In other words, the loop must be set up to run 700 iterations, so as to collect 700 samples for each channel, i.e. 700 arrays of `double` elements, which will be later distributed into a two-dimensional array containing each sample per channel (the acquisition here described is performed in one trial). That would be a memory-inefficient algorithm, and therefore just one array is used as a buffer array, into which the “raw” acquisition data are placed, which are then distributed into another two-dimensional array, set up as to contain each sample per channel, and thus the next sample for the next channel is filled in at the appropriate spot. This way, through the process of *data decimation*, at the end of the acquisition, an array, that contains 700 samples for as many rows as selected, will be obtained, which is easy to convert into the form useful for drawing on the screen.

However, since, during the acquisition, the S1 and S2 stimuli need to be applied, the acquisition becomes more complicated. Therefore, it is separated into three parts: pre-S1, between S1 and S2, and post-S2. The pre-S1 part is the simplest, as there are no stimuli applied, and this is the so-called “baseline” recording, where data are simply gathered and stored. This part lasts for one second.

The second part, between S1 and S2, lasts for two seconds, and is a bit more complex, in a sense that the S1 stimulus must be applied for a certain period of time, while the acquisition takes place. The solution is to load the sound for the S1

stimulus into an asynchronous sound player (which is an option available in C#), i.e. another so-called “server” for playing the sound, and let it play *before* the beginning of the loop that will acquire the 200 samples between the moment of application of S1 and S2. Since the sound itself lasts for 200 milliseconds, and the press button won’t be applied in this period, there is no need for it to be manually interrupted.

The third part, after S2, lasts for four seconds (to add up to a total of 7 seconds of acquisition) and is the most complex to program. First, for each sample of acquisition, the previous sample value of the press button channel must be kept, to check whether a press of the button occurred in that sample. Afterwards, the acquisition occurs. Next, a test is performed, whether the S2 stimulus should be sounded. If a CNV potential is absent, if the S2 stimulus hasn’t been sounded yet (i.e. if the third part of the acquisition is at its beginning) and if the press of the button hadn’t occurred yet, the S2 stimulus is sounded, again asynchronously. If any of the aforementioned becomes false, the S2 stimulus is stopped, i.e. isn’t allowed to be played for the remainder of the third part of the acquisition.

During the acquisition, the “line” values are also calculated, i.e. the moments of application of the S1 stimulus, the S2 stimulus and the press of the button (i.e. the reaction time). Also, at the moment of application (or not) of the S2 stimulus, information is stored for the current trial whether the S2 stimulus is present, and whether a CNV potential has been detected in that trial.

## **A.5. Filtering**

It can be said that the data decimation, explained in the previous section, is one half of the signal pre-processing, i.e. arranging the signal values in such a way so as to distribute the values among channels. The other half is *filtering*, i.e. removing the unwanted signal frequencies. Since the paradigm requires that the subject be relaxed, the alpha frequency will be the dominant frequency in the obtained signal, and therefore all high signal frequencies need to be filtered out. This is not the case for the EMG signal (in case it is recorded), as the EMG signals usually have high-frequency components.

In this case, the cutoff frequency for the low-pass filter is 15 Hz. All frequencies above it are removed, and also the DC component (i.e. the 0 Hz component) of the signal is filtered out. Again, this is not the case when handling the EMG signal.

The filtering is performed using the direct Fourier transform method: the signal is first converted into frequency domain, and certain values of the thus obtained signal are set to zero, after which, using the inverse Fourier transform, the signal is returned back to the time domain. Because both Fourier transforms require operations involving complex numbers, which are not built into the .NET 2.0, a special class of complex numbers, called `Complex`, was created. It contains methods for complex number definition, as well as overloads of the basic binary

operators (+, -, \*, /) between a complex and another complex or real operand. Also, functions for absolute value and complex exponent are also built in, the latter being of key importance for successful Fourier transform-based filtering.

Since the signal is digital, it is discrete by nature, so the discrete Fourier transforms must be used. Equations A.1. and A.2. show the formulae for the direct and inverse discrete Fourier transform, respectively.

$$X(k) = \sum_{n=0}^{N-1} x(n) \cdot e^{-i \cdot 2 \cdot \pi \cdot \frac{k}{N} \cdot n} \quad (A.1.)$$

$$x(n) = \frac{1}{N} \cdot \sum_{k=0}^{N-1} X(k) \cdot e^{i \cdot 2 \cdot \pi \cdot \frac{k}{N} \cdot n} \quad (A.2.)$$

In both cases,  $x(n)$  is the time-domain signal and is a real value, whereas  $X(k)$  is the signal in the frequency domain and is a complex value.  $N$  is the signal length,  $n$  is the time-domain sample, and  $k$  is the frequency-domain sample.

The principle is as follows. Both the real and the complex signal have the same amount of samples, namely  $N = 700$ . The direct Fourier transform produces a complex signal, in which each sample shows the effect of a certain frequency on the overall signal. Since the signal in the frequency domain also has 700 samples, and the sampling frequency is 100 Hz, each sample represents the effect of one seventh of a hertz to the overall signal. Having this in mind, filtering out the unwanted frequencies means simply setting the unwanted frequency samples to zero. In this case, the frequencies above 15 Hz, i.e. samples with indices above  $15 \cdot 7 = 105$ , are set to zero, as well as sample indexed 0, i.e. the frequency of 0 Hz, which is the DC component. Then, applying the inverse Fourier transform on this newly obtained signal, the filtered signal in time domain is obtained.

## A.6. ERP Extraction

The ERP extraction feature is explained in equation (6.5.) in the text, and is repeated here as equation (A.3.) for clarity:

$$ERP(s, t) = pERP(s, t-1) + qEEG(s, t) \quad (A.3.)$$

where  $s$  ( $s = 1, 2, \dots, N$ ) is the sample number in a trial,  $t$  ( $t = 1, 2, \dots, T$ ) is the experimental trial number, and  $p$  and  $q$  are weighted parameters, satisfying  $p + q = 1$ . For the parameters ( $p, q$ ) in this research the values (0.9, 0.1) are used. This is, in fact, a neural network learning method, which is efficient for extracting a time-varying ERP, such as in this case.

This method of computing the ERP is relatively straightforward, since it involves only a simple sample-by-sample multiplication and addition, which is easy

once the signal is placed in an array. After the ERP extraction, the ERP signal (stored in channel 6) is ready to be tested for presence or absence of the CNV potential.

## A.7. CNV Recognition and S2 Management

Recognizing the presence or absence of CNV is easy, once the ERP is placed in an array and the noise artifacts are removed. Values of the samples with indices from 295 to 300 are averaged, and from this value the “baseline” value (i.e. the average of the values of samples with indices from 0 to 100) is subtracted. In other words, the average value of the signal 50 milliseconds before S2 to the moment of applying S2 represents the “high end” of the CNV slope, whereas the first second of acquisition represents the “baseline” according to which the CNV slope is calculated. The value of the difference needs to be 5  $\mu\text{V}$  or more, for the signal to be considered as a CNV potential.

There is also the possibility of calculating the linear regression of the slope of the signal between S1 and S2, but this approach has proved unnecessary, as the amplitude difference is a sufficient parameter for an accurate estimate of the CNV potential. Nevertheless, the value for the linear regression slope is calculated according to equation A.4.

$$a = \frac{N \cdot \sum_{i=1}^N x_i y_i - \sum_{i=1}^N x_i \cdot \sum_{i=1}^N y_i}{N \cdot \sum_{i=1}^N x_i^2 - \left(\sum_{i=1}^N x_i\right)^2} \quad (\text{A.4.})$$

where  $a$  is the regression slope,  $N$  is the number of samples in the signal,  $x_i$  is the sample index, and  $y_i$  is the value of the sample at that index. Values of samples with indices from 150 to 295 are usually taken into consideration. The slope of linear regression needs to be 3.6  $\mu\text{V}/\text{s}$  or more, for the signal to be considered a CNV.

However, it is possible that the signal might have a lot of artifacts, and that the amplitude difference may exceed the 5  $\mu\text{V}$  threshold due to noise. For this reason, a counter is present, which counts how many times the amplitude is greater than 5  $\mu\text{V}$ . If this happens 3 trials in a row, the CNV is recognized as present, the S2 stimulus is switched off and a control signal is sent to the appropriate robot. If, on the other hand, the CNV has been present and needs to be recognized as absent, another counter counts how many trials in a row the amplitude difference has fallen below 5  $\mu\text{V}$ . If this has happened in 2 trials in a row, the CNV is recognized as absent, the S2 stimulus is switched on, and a control signal is sent to the appropriate robot.



## A.8. The Graphical User Interface: Data Representation

At this point, the acquisition has ended, the data have been decimated into channels and filtered, the reaction time has been calculated, the CNV has been recognized or not, also whether the S2 stimulus should be present in the current trial, as well as which robot should be moved using which behavior. All of these data are stored in the three-dimensional array of `double` values, as well as in the one-dimensional array of `TrialData` values. The next step is to present the data graphically on the screen.

The .NET 2.0 environment has a very rich collection of libraries for creating Windows applications, which has been utilized here. The `CheckBox` class for representing the channels that are enabled for acquisition is an example of such a class. Also, static text messages are displayed on `Labels`, whereas text that can be edited is entered and read from `TextBoxes`. User interaction is enabled through the use of `Buttons`. The graphical data is displayed on 6 `Panel`s, which correspond to the 6 rows of the current trial of the three-dimensional array of `double` values.

To be able to hold graphical content, each of these classes must be associated with a `Graphics` object. However, since graphical data are displayed only on the `Panel`s, a `Graphics` object is linked with each one of them only. This way, an array of 6 `Graphics` objects is created, one for each `Panel`. Also, since a `Point` object represents a graphical point, an array of `Point` arrays is declared, which will then be instantiated for each `Graphics` object, i.e. each `Panel`. This is done this way, because a `DrawLines` method of the `Graphics` object accepts an array of `Point` objects (each containing two coordinates) and then draws them on the corresponding `Graphics` object.

However, because the received signals would likely be with amplitudes that exceed the height of the panels, they are *normalized*, so that the maximum value of the 7 seconds of signal length is placed at the top of the panel at its corresponding place, and the lowest value of the signal is placed at the bottom of the panel, at its corresponding place. The coordinate system of the `Graphics` object is inverted, i.e. the higher the value of the vertical coordinate, the lower the point is placed on the screen. Therefore, the following system of equations would ensure that the signal gets normalized within the limits of the `Panel`:

$$\begin{aligned}k \cdot \min + n &= \textit{high} \\k \cdot \max + n &= \textit{low}\end{aligned}\tag{A.5.}$$

where  $k$  is the linear slope coefficient,  $n$  is the displacement,  $\min$  and  $\max$  are the minimum and maximum value of the signal respectively and *high* and *low* are the highest coordinate (lowest point) and lowest coordinate (highest point) of the `Panel`, respectively. Solving for  $k$  and  $n$ , the following results are obtained:

$$k = \frac{high - low}{min - max} \quad n = \frac{low \cdot min - high \cdot max}{min - max} \quad (A.6.)$$

Now, using the linear transformation

$$k \cdot x + n = y \quad (A.7.)$$

where  $x$  is the value of each sample, the  $y$ -coordinate of the point for each sample on the screen is obtained. And since the values of the points along the  $x$ -axis are the same as the sample indices, this way both coordinates for each point, corresponding to each sample, are obtained. In other words, an array of `Points` is directly obtained, which can then be used to draw out the entire signal on the screen, in the corresponding `Panel`.

Of course, this means that the minimum and maximum values drawn in the `Panels` will always be different, i.e. that the signal will be displayed only qualitatively. This is sufficient, however, since it is not the actual amplitude of the ERP that is of interest for CNV recognition, but the *amplitude difference* between certain points of the signal. Also, since the DC component is also filtered out, the signal will always have its extreme values on both sides of the zero value. In any case, the extreme values of the current signal are also displayed on each `Panel`. Figure A.6. shows an example of graphical data display.

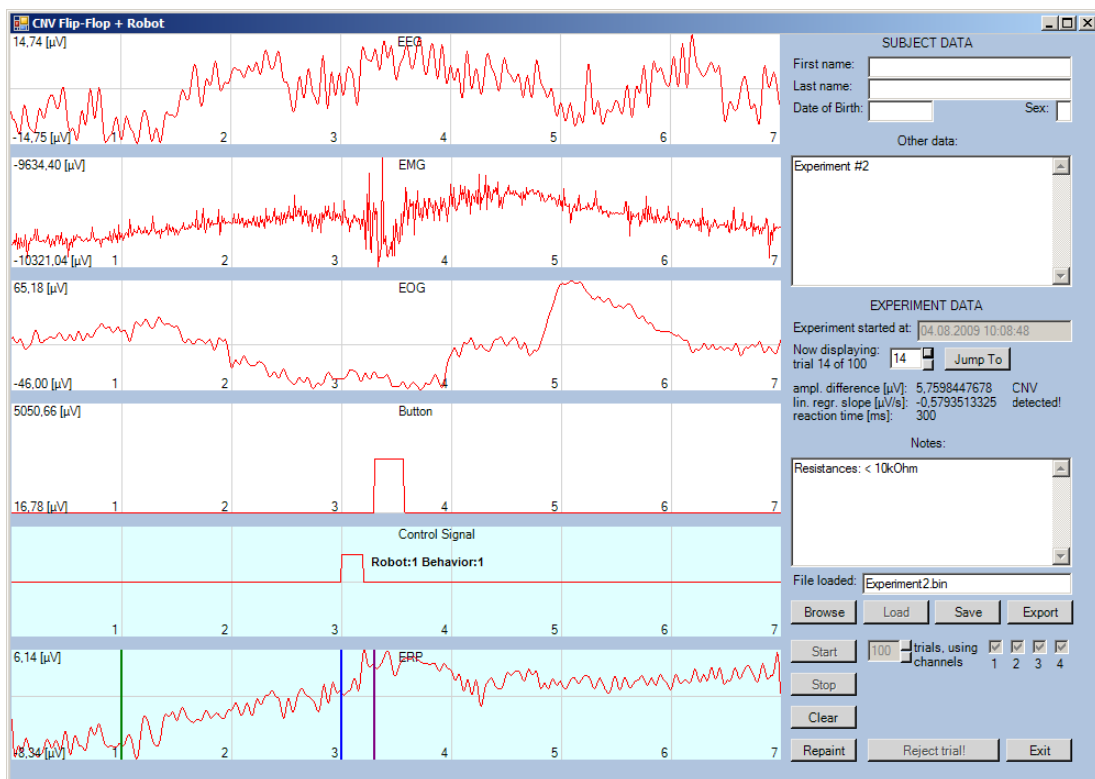

Figure A.6. Graphical data display

It can be observed that the Control Signal channel (second from bottom) does not adhere to the aforementioned normalization method. This is so, because the only information that is stored in this channel is whether a control signal has been sent. Therefore, no normalization is necessary, since the signal will have only two possible appearances, i.e. one of an empty signal and one of a control pulse sent to the robot. Also, on this channel, a textual representation of which robot has been moved, using which behavior, is displayed.

## A.9. Robot Control

In the case of controlling two robotic arms, two classes that will communicate with each one of them, are derived. They are called `Lynx6` and `Lynx5` respectively. Since both robotic arms are controlled using a SSC-32 servo-controller each, the structure of sending commands to both robots will be the same.

Namely, first a `SerialPort` object is instantiated, which will set up a serial port for communication with each robotic arm. This object will specify the serial port through which the hardware connection is established between the computer and the controller, rate (in bits per second) of communication, the parity check choice, the number of data bits in a packet sent through the port, and the number of stop bits.

To move a certain motor of the robot to a certain position, three bytes must be sent to the servo-controller: a control message (seven ones, i.e. a byte representation of 255), the motor number and the position. The servo-controller then translates these messages into movements of the motor, so it would reach the given position. This is the most basic way of operating a robotic arm.

However, a method has been devised, that would enable the positions of all the motors to be given at a moment, and the motors would all reach the end positions at the same time. This is achieved by breaking down the full range of motion that each motor must perform into individual steps. There is an equal amount of steps for each motor to perform, and the amount of displacement that each motor will traverse in each step depends on the difference between the end position and the initial position. There is also an option for a time delay, which enables the user to control the speed of motion of the motors.

This gives the opportunity to preprogram the robot motions. An array of an array of an array of `byte` elements is declared, whereas

- the first array contains the behavior that should be performed at the given time (7 moves, i.e. behaviors, are necessary to solve the Towers of Hanoi problem with three disks);
- the second array contains the motion of the robotic arm within the behavior, which is necessary to fully complete the behavior (such as approaching to the disk, grasping it, pulling it away upwards, moving to the destination position, approaching, releasing the disk, etc). There are 9 motions that are needed for completion of each behavior;

- the third array contains the positions of each of the motors of the robot. For a Lynx6 robotic arm, this array has 6 elements, whereas for a Lynx5 robotic arm, this array has 5 elements (because Lynx6 and Lynx5 have 6 and 5 degrees of freedom, respectively).

Preprogramming the robot behaviors has the advantage that the computer can always know which behavior is needed to be executed next. Thus, when the conditions are met (appearance or disappearance of CNV), the appropriate behavior is invoked, which is then decomposed to motions, which are then decomposed to sequences of robot motor positions, which are sent to the servo-controller of the appropriate robotic arm one by one.

## A.10. Trial Rejection

At times, the experimenter may decide that an experimental trial should not be included into the ERP calculation, due to noise, artifacts, etc. The experimenter can reject such a trial, using the “Reject Trial” button, at the bottom right of the screen. Figure A.7. shows an example of a rejected trial.

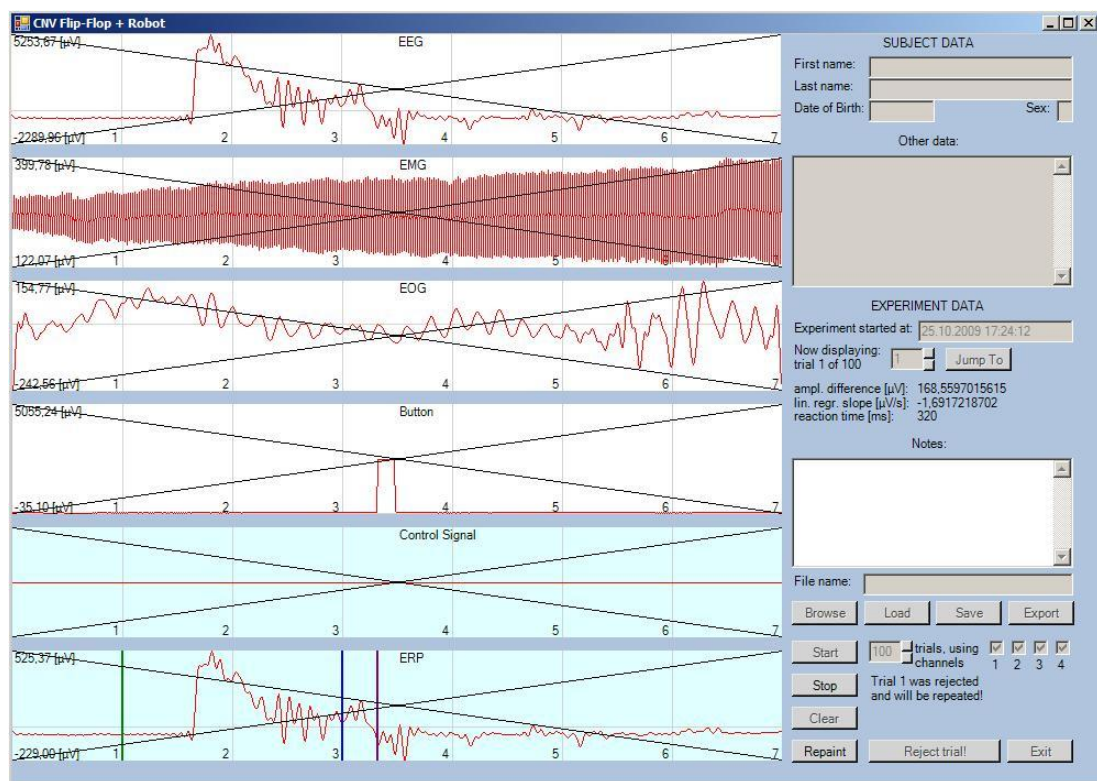

Figure A.7. An example of a rejected trial

Because rejected trials are very common during experiments, the following data are backed up before the acquisition starts in the current trial: the ERP channel data, the counter of how many trials in a row the signal had gone above the threshold, the counter of how many trials in a row the signal had gone below the threshold, as well as whether the CNV potential had been recognized in the current

trial. Should there be a rejection, these data are written back to their corresponding positions in the memory, and the trial number is taken one back. In this sense, the trial will be repeated as many times as it gets rejected, and there is no limit as to how many rejected trials in the experiment there can be.

### **A.11. Data Storage and File Management**

After the experiment has ended, whether successfully or by the user, it may be necessary to store the experiment data in a file. Two methods of data preserving are available: saving the data and exporting the data.

Saving the data means writing it to a binary file, which cannot be read by the user, but which can later be retrieved by the computer. First, the number of trials in the experiment is written, so that the appropriate amount of memory could be reserved upon loading of the experiment. Then, the information about the subject is written, as well as about the experiment itself (e.g. on what date and what time it has been started etc). After this, the trial-dependent data follow: the signal samples for all channels, the locations of the “lines”, i.e. moments of application of the first stimulus, the second stimulus and the button press, as well as the relevant information for each trial, such as the amplitude difference upon CNV recognition, the linear regression slope calculation, the reaction time, whether CNV has been recognized in that trial and whether the S2 stimulus has been applied in that trial.

Exporting of the data means outputting a textual representation of these data, which the user can later put into another program and work with, for example to extract some statistical information. The subject and experiment data are written out first, followed by numerical representation of the trial-dependent data. The actual signal values are not exported, since their use is primarily to offer a graphical display of the data.

Loading the data follows the exact same sequence of steps as saving it, except that the data are read from a file, instead of being written into it. To locate the experiment files more easily, a Browse button has been added, which opens a browsing form, which enables the user to locate the files anywhere on the disk and load them into memory.

## LIST OF USED ABBREVIATIONS

AEP	Auditory Evoked Potentials
BAEP	Brainstem Auditory Evoked Potentials
BCI	Brain-Computer Interface
BP	Bereitschaftspotential
CNV	Contingent Negative Variation
dB	decibel
DC	Direct current
DOF	Degrees of Freedom
EEG	Electroencephalogram
EI-HCI	Electrophysiologically Interactive Human-Computer Interfaces
EMCG	Electromasticatiogram
EMG	Electromyogram
EOG	Electooculogram
EP	Evoked potential
ERP	Event-Related Potential
EXG	Electroexpectogram
fMRI	Functional Magnetic Resonance Imaging
GUI	Graphical User Interface
HCI	Human-Computer Interface
Hz	hertz
ICA	Independent Component Analysis
ISI	Inter-stimulus interval
ITI	Inter-trial interval
MEG	Magnetoencephalography
min	Minute/Minutes
ms	millisecond
PET	Positron Emission Tomography
RAM	Random-Access Memory
REM	Rapid eye movement
RT	Reaction time
SEP	Somatosensory Evoked Potentials
SSVEP	Steady-State Visually Evoked Potential
SW	Slow Wave
TV	Television
TOH	Towers Of Hanoi
USB	Universal Serial Bus
V	Volt
VEP	Visual Evoked Potentials
$\mu$ Pa	micropascal
$\mu$ V	microvolt

# **BRAIN-COMPUTER INTERFACE BASED ON ANTICIPATORY BRAIN POTENTIALS**

## **Dissertation Summary**

Brain-Computer Interface (BCI) is about controlling devices directly with brain potentials, bypassing the external motor organs such as arms or legs. It is a part of Human-Computer Interaction (HCI) research, which itself is a part of computer science. Starting from punched cards, through keyboards, mouse, multimedia, a new possibility now is interaction through physiological signals, including brain signals.

The human brain generates various types of potentials, depending on the task considered. So far, the mental states used in BCI are the state of relaxation (alpha rhythm), the state of mental task, such as calculation (beta rhythm), the state of response to stimuli (evoked potentials), the state of intention to move (mu rhythm), and the state of expectation (CNV potential). The CNV potential in a BCI paradigm was first introduced in this work.

Experimental research (materials and methods) in this dissertation is carried out using a special experimental paradigm, which is called the CNV flip-flop paradigm. A subject hears two auditory stimuli, S1 (warning) and S2 (imperative, to be reacted on) stimulus. The brain develops expectation (S2/S1) on S2, given S1. When the expectation produces a certain level of CNV amplitude, the computer turns off the S2 signal. Since there is no S2, the CNV potential disappears. The computer turns on the signal S2 again, and after several trials the CNV reappears. The paradigm generates an oscillatory process in the brain, which produces series of appearances and disappearances of the CNV potential. The paradigm tackles a difficult problem in signal processing, namely dealing with a time varying potential. A neural network learning algorithm to deal with this problem was used.

The BCI experimental research is based on controlling a robotic arm using the CNV flip-flop paradigm. The demonstration task is the Towers of Hanoi (TOH) problem, well known in computer science. A set of behaviors are preprogrammed to move one disk at a time toward the solution of the problem. For two-disk and three-disk TOH, three moves and seven moves are needed respectively. It was shown that using the CNV flip flop paradigm, a subject is able to generate series of CNV and noCNV events, that will reach the solution of the Towers of Hanoi problem with two and three disks.

The main contribution of this work is introducing the anticipatory brain potentials in the BCI research and achieving control of a robot using them. Also, it is shown how two robotic arms, working together on the same problem (namely the Towers of Hanoi with three disks), can be simultaneously controlled using this paradigm. This is the first time that such a thing has been achieved in the world.

# SUČELJE MOZGA S RAČUNALOM ZASNOVANO NA ANTICIPACIJSKIM POTENCIJALIMA MOZGA

## Sažetak disertacije

Sučelje mozga s računalom (Brain-Computer Interface – BCI) je oblast istraživanja u kojoj se uređaji upravljaju izravno s pomoću potencijala mozga, zaobilazeći vanjske motoričke organe (ruke i noge). Ovo područje je dio šireg područja istraživanja interakcije čovjeka s računalom (Human-Computer Interaction – HCI), koje je samo po sebi dio računarskih i komunikacijskih tehnologija.

Ljudski mozak generira različite vrste potencijala, ovisno o zadatku. Za sada, mentalna stanja koja se koriste u BCI-ju su stanje opuštenosti (alfa ritam), stanje mentalne angažiranosti (beta ritam), stanje odgovora na stimuluse (evocirani potencijali), stanje namjere za pokret (mu ritam) i stanje očekivanja (CNV potencijal). CNV potencijal u BCI paradigmi je predmet istraživanja prvi put uveden u ovom radu.

Eksperimentalno istraživanje (materijali i metode) u ovoj disertaciji izvedeno je s pomoću eksperimentalne paradigme nazvane CNV flip-flop paradigma. Ispitanik prima dva zvučna podražaja S1 (upozoravajući) i S2 (imperativni, na koji treba reagirati). Mozak razvija potencijale očekivanja (S2/S1) na S2, nakon zadatog S1. Kada ti potencijali pređu određenu razinu CNV amplitude, računalo isključi stimulus S2. Budući da više nema S2, CNV potencijal nestaje. Računalo tada ponovo uključuje S2 i, nakon nekoliko pokusa, CNV se ponovo pojavljuje. Paradigma izaziva oscilatorni proces u mozgu, koji proizvodi niz pojavljivanja i gubljenja CNV potencijala. Paradigma se suočava s problemom obradbe vremenski promjenljivih signala. U radu je za obradbu signala kognitivne aktivnosti mozga korištena metoda zasnovana na neuronskim mrežama.

Eksperimentalno istraživanje BCI je zasnovano na upravljanju robotske ruke pomoću CNV flip-flop paradigme. Prikazano je rješavanje problema Hanojskih tornjeva (Towers of Hanoi – TOH), dobro poznatog u računarstvu. Skup ponašanja robota je preprogramiran, kako bi se izvvela micanja diskova u tornjevima prema pravilima dolazeći tako do rješenja problema. Za probleme tornjeva sa dva i tri diska potrebna su odgovarajuće tri i sedam micanja. Pokazano je da je, pomoću CNV flip-flop paradigme, ispitanik u stanju proizvesti niz pojavljivanja i gubljenja CNV potencijala, koji donose rješenje problema.

Glavni doprinos rada je uvođenje anticipacijskih potencijala mozga u BCI istraživanja i izvedbu upravljanja robota pomoću njih. Također je pokazano da je istim principom, s pomoću anticipacijskih potencijala mozga, moguće upravljati i s dvije robotske ruke (dva uređaja istovremeno).



## CURRICULUM VITAE

Adrijan Božinovski, M. Sc., was born 30.9.1977 in Skopje, Macedonia. He attended primary and secondary school in Skopje, and finished both with honors. During the course of his education, he attended numerous mathematics and physics competitions. He attended additional education in Wallingford, CT, USA, as a winner of a prize on a Soros foundation contest. He completed a part of his high-school education in Amherst, MA, USA.

He enrolled the Sts. Cyril and Methodius University in Skopje, the Electrical Engineering Faculty, majoring in Computer science, informatics and automatics, from where he graduated in 2002. In 2003 he was on a traineeship in Switzerland, in the company Tele Atlas Schweiz AG, where he worked on geographic information systems.

He completed his M.Sc. thesis, titled “Application of Anticipatory Brain Potentials in Medical Research and Brain-Computer Communication”, in 2007, on the Faculty of Electrical Engineering and Computing in Zagreb, Croatia. The same year, on the same institution, he enrolled in his Ph.D. studies.

In 2005 he started working in the Medical Faculty, Institute of Physiology, as a bioinformatics engineer, where he took care of the medical equipment, and also assisted in laboratory exercises where there was need of computer-aided demonstration. In 2005-2007 he participated in a Macedonian-Croatian bilateral scientific project on anticipatory brain potentials. Since 2007 he is with the University American College Skopje, School of Computer Science and Information Technology, as an Assistant Lecturer. However, he kept active collaboration with the Institute of Physiology, as a bioinformatics engineer.

His main research interest is in the field of controlling robotic devices in a brain-computer interface paradigm using anticipatory brain potentials. He has published numerous papers and received international recognition for his work.

## ŽIVOTOPIS

M-r inž. Adrijan Božinovski je rođen 30.9.1977 godine u Skopju, Makedonija. Osnovnu i srednju školu pohađao je i završio u Skopju, obadviije sa odličnim uspjehom. U toku svoje naobrazbe učestvovao je na natječaje iz matematike i fizike. Pohađao je dopunsku naobrazbu u Walligfordu, Connecticut, Sjedinjene Američke Države, kao nagrađeni na natječaju fondacije Soros. Dio svoje naobrazbe u toku srednje škole završio je u srednjoj školi u Amherstu, Massachusetts, SAD.

Na sveučilištu „Sv. Kiril i Metodij“ u Skopju, upisao je Elektrotehnički fakultet, na smjeru Računarska tehnika, informatika i automatika. U 2002 godini je izradio i obranio svoji diplomski rad. 2003 godine je bio na stručnom usavršavanju u Švicarskoj, u tvrtki Tele Atlas Schweiz AG, gdje je radio na geografskim informacijskim sustavima.

Završio je poslijediplomski magistarski studij na Fakultetu elektrotehnike i računarstva u Zagrebu, Hrvatska. Magistarski rad pod naslovom „Primjena anticipacijskih moždanih potencijala u medicinskim istraživanjima i komunikaciji mozak – računalo“ uspješno je obranio 2007 godine. Iste godine je upisao doktorski studij na istom fakultetu.

U 2005 godini se zaposlio na Medicinskom fakultetu u Skopju, na Insistutu za fiziologiju, kao bioinformatički inženjer, gdje se brinuo o elektroničkoj aparaturi i također učestvovao u laboratorijskim vežbama, gdje je bila potrebna pomoć računala, kao demonstrator. Od 2007 godine radi na Sveučilištu American College Skopje, na Fakultetu za Računarske znanosti i Informatičke tehnologije, gdje radi kao asistent. Zadržao je aktivnu suradnju sa Institutom za fiziologiju kao bioinformatički inženjer. U 2005-2007 učestvovao je u Makedonsko-Hrvatskom bilateralnom znanstvenom projektu istraživanja anticipacijskih potencijala mozga.

Oblast njegovog glavnog istraživanja jeste upravljanje robotskih uređaja u sučelju mozak-računalo, koristeći anticipacijske potencijale mozga. Objavio je brojne radove i dobio međunarodna priznanja za svoj rad.