

Genetic diversity of brown trout (*Salmo trutta* L., 1758) of the Danube basin on the territory of Croatia

Kanjuh, Tamara

Doctoral thesis / Disertacija

2023

Degree Grantor / Ustanova koja je dodijelila akademski / stručni stupanj: **University of Zagreb, Faculty of Agriculture / Sveučilište u Zagrebu, Agronomski fakultet**

Permanent link / Trajna poveznica: <https://um.nsk.hr/um:nbn:hr:204:499882>

Rights / Prava: [In copyright](#) / [Zaštićeno autorskim pravom.](#)

Download date / Datum preuzimanja: **2024-07-20**



Repository / Repozitorij:

[Repository Faculty of Agriculture University of Zagreb](#)





University of Belgrade
Faculty of Biology



University of Zagreb
Faculty of Agriculture

Tamara Kanjuh

**GENETIC DIVERSITY OF BROWN
TROUT (*Salmo trutta* L., 1758) OF THE
DANUBE BASIN ON THE TERRITORY
OF CROATIA**

INTERNATIONAL DUAL DOCTORATE

Zagreb, 2023.



Univerzitet u Beogradu
Biološki fakultet



Sveučilište u Zagrebu
Agronomski fakultet

Tamara Kanjuh

**GENETIČKA RAZNOLIKOST POTOČNE
PASTRVE (*Salmo trutta* L., 1758)
DUNAVSKOG SLIJEVA NA PODRUČJU
HRVATSKE**

MEĐUNARODNI DVOJNI DOKTORAT ZNANOSTI

Zagreb, 2023.



University of Belgrade
Faculty of Biology



University of Zagreb
Faculty of Agriculture

Tamara Kanjuh

**GENETIC DIVERSITY OF BROWN TROUT
(*Salmo trutta* L., 1758) OF THE DANUBE
BASIN ON THE TERRITORY OF CROATIA**

INTERNATIONAL DUAL DOCTORATE

Supervisors:
Assist. prof. Ana Marić, PhD
Prof. Marina Piria, PhD

Zagreb, 2023.



Univerzitet u Beogradu
Biološki fakultet



Sveučilište u Zagrebu
Agronomski fakultet

Tamara Kanjuh

**GENETIČKA RAZNOLIKOST POTOČNE
PASTRVE (*Salmo trutta* L., 1758)
DUNAVSKOG SLIJEVA NA PODRUČJU
HRVATSKE**

MEĐUNARODNI DVOJNI DOKTORAT ZNANOSTI

Mentori:

Doc. dr sc. Ana Marić
Prof. dr sc. Marina Piria

Zagreb, 2023.

Bibliography data

Scientific area: **Biotechnical sciences**
Scientific field: **Agriculture**
Scientific branch: **Fisheries**
Institution: **University of Zagreb, Faculty of Agriculture**
University of Belgrade, Faculty of Biology
Supervisors of doctoral thesis: **Doc. dr Ana Marić, PhD**
Prof. Marina Piria, PhD

Number of pages: **106**
Number of figures: **26**
Number of tables: **20**
Broj priloga: **2**
Number of references: **223**

Doctoral thesis defence date: _____._____._____.
Committee for doctoral thesis defence:

1. **Prof. Tea Tomljanović, PhD**
University of Zagreb, Faculty of Agriculture
2. **Prof. Ivana Maguire, PhD**
University of Zagreb, Faculty of Science
3. **Assoc. Prof. Lidija Svečnjak, PhD**
University of Zagreb, Faculty of Agriculture
4. **Prof. Predrag Simonović, PhD**
University of Belgrade, Faculty of Biology
5. **Prof. Vera Nikolić, PhD**
University of Belgrade, Faculty of Biology
6. **Dr Marija Smederevac-Lalić, PhD**
Institute for Multidisciplinary Studies – University of Belgrade

This thesis has been stored in **National and University Library in Zagreb, Ulica Hrvatske bratske zajednice 4 p.p 550, 10 000 Zagreb, Library of the University of Zagreb, Faculty of Agriculture, Svetošimunska cesta 25, 10 000 Zagreb.**

The topic of the dissertation was approved at the meeting of the Faculty Council of the University of Zagreb Faculty of Agriculture on _____._____._____ and approved at the meeting of the Senate of the University of Zagreb on _____._____._____.

Bibliografski podaci

Znanstveno područje: **Biotehničke znanosti**

Znanstveno polje: **Poljoprivreda**

Znanstvena grana: **Ribarstvo**

Institucija: **Sveučilište u Zagrebu, Agronomski fakultet**

Univerzitet u Beogradu, Biološki fakultet

Voditelji doktorskog rada: **Doc. dr sc. Ana Marić**

Prof. dr sc. Marina Piria

Broj stranica: **106**

Broj slika: **26**

Broj tablica: **20**

Broj priloga: **2**

Broj literaturnih referenci: **223**

Datum obrane doktorskog rada: _____._____._____.

Sastav povjerenstva za obranu doktorskog rada:

1. **Prof. dr sc. Tea Tomljanović**

Sveučilište u Zagrebu, Agronomski fakultet

2. **Prof. dr sc. Ivana Maguire**

Sveučilište u Zagrebu, Prirodoslovno-matematički fakultet

3. **Izv. prof. dr sc. Lidija Svečnjak**

Sveučilište u Zagrebu, Agronomski fakultet

4. **Prof. dr sc. Predrag Simonović**

Univerzitet u Beogradu, Biološki fakultet

5. **Prof. dr sc Vera Nikolić**

Univerzitet u Beogradu, Biološki fakultet

6. **Dr sc. Marija Smederevac-Lalić**

Institut za multidisciplinarnu studiju Univerziteta u Beogradu

Rad je pohranjen u Nacionalnoj i sveučilišnoj knjižnici u Zagrebu, Ulica Hrvatske bratske zajednice 4 p.p. 550, 10 000 Zagreb, Knjižnici Sveučilište u Zagrebu Agronomskog fakulteta, Svetošimunska cesta 25, 10 000 Zagreb.

Tema rada prihvaćena je na sjednici Fakultetskog vijeća Sveučilište u Zagrebu Agronomskog fakulteta, održanoj dana _____._____._____, te odobrena na sjednici Senata Sveučilišta u Zagrebu, održanoj dana _____._____._____.

UNIVERSITY OF ZAGREB
FACULTY OF AGRICULTURE

DECLARATION OF ORIGINALITY

I, **Tamara Kanjuh**, declare that I have composed solely by myself the thesis titled:

**GENETIC DIVERSITY OF BROWN TROUT (*Salmo trutta* L., 1758) OF THE DANUBE
BASIN ON THE TERRITORY OF CROATIA**

With my signature I confirm that:

- I am the sole author of this thesis;
- this thesis is an original report of my research, and references have been provided for all supporting literature and resources;
- I am familiar with the provisions of the Code of Ethics of the University of Zagreb (Article 19).

Zagreb, ____ . ____ . ____ .

(PhD Candidate signature)

SVEUČILIŠTE U ZAGREBU
AGRONOMSKI FAKULTET

IZJAVA O IZVORNOSTI

Ja, **Tamara Kanjuh**, izjavljujem da sam samostalno izradila doktorski rad po naslovom:

**GENETIČKA RAZNOLIKOST POTOČNE PASTRVE (*Salmo trutta* L., 1758) DUNAVSKOG
SLIJEVA NA PODRUČJU HRVATSKE**

Svojim potpisom jamčim:

- da sam jedina autorica ovoga doktorskog rada;
- da je doktorski rad izvorni rezultat mojeg rada, te da se u izradi istoga nisam koristila drugim izvorima osim onih koji su u njemu navedeni;
- da sam upoznata s odredbama Etičkog kodeksa Sveučilišta u zagrebu (Čl. 19).

Zagreb, ____ . ____ . ____ . godine

(Potpis doktorandice)

Doctoral thesis grade

Doctoral thesis was defended at the University of Belgrade, Faculty of Biology on ____ . ____ . ____ . godine in front of the PhD defense committee comprised of:

1. Prof. Tea Tomljanović, PhD _____

University of Zagreb, Faculty of Agriculture

2. Prof. Ivana Maguire, PhD _____

University of Zagreb, Faculty of Science

3. Assoc. Prof. Lidija Svečnjak, PhD _____

University of Zagreb, Faculty of Agriculture

4. Prof. Predrag Simonović, PhD _____

University of Belgrade, Faculty of Biology

5. Prof. Vera Nikolić, PhD _____

University of Belgrade, Faculty of Biology

6. Marija Smederevac-Lalić, PhD _____

Institute for Multidisciplinary Studies – University of Belgrade

Ocjena doktorskog rada

Doktorski rad je obranjen na Biološkom fakultetu Univerzitetu u Beogradu

____. _____. _____ . godine pred povjerenstvom u sastavu:

1. Prof. dr sc. Tea Tomljanović _____

Sveučilište u Zagrebu, Agronomski fakultet

2. Prof. dr sc. Ivana Maguire _____

Sveučilište u Zagrebu, Prirodoslovno-matematički fakultet

3. Izv. prof. dr sc. Lidija Svečnjak _____

Sveučilište u Zagrebu, Agronomski fakultet

4. Prof. dr sc. Predrag Simonović _____

Univerzitet u Beogradu, Biološki fakultet

5. Prof. dr sc Vera Nikolić _____

Univerzitet u Beogradu, Biološki fakultet

6. Dr sc. Marija Smederevac-Lalić _____

Institut za multidisciplinarnu studiju Univerziteta u Beogradu

Supervisor 1 information

Assist. prof. Ana Marić, PhD

Department of Morphology, Systematics and Phylogeny of Animals

University of Belgrade, Faculty of Biology

Studentski trg 16, 11 000 Belgrade, Serbia

e-mail: anatosic@bio.bg.ac.rs

Ana (Tošić) Marić was born on January 10, 1985 in Belgrade, where she completed elementary school and high school. In 2003, she entered the Faculty of Biology, University of Belgrade, Department of Ecology and Environmental Protection. She graduated in 2010 with an average grade of 8.94, and she defended her graduation thesis entitled “The Amazonian species *Pterygoplichthys pardalis* (Castelnau, 1855) (Loricariidae, Siluriformes), discovered in the Serbian part of the Danube River” with a grade of 10. In the same year, she enrolled in doctoral studies at the Faculty of Biology, University of Belgrade at the Department of Morphology, Systematics and Phylogeny of Animals. In June 2010, she was employed at the Department of Morphology, Systematics and Phylogeny of Animals at the Faculty of Biology, University of Belgrade as a Researcher Intern, and already in November 2011, she was elected to the Associate Researcher. Since 2010, she has been participating in the teaching of the course Introduction to Ichthyology, and since 2014 also in the course Vertebrate Zoology at undergraduate studies. She participated in the implementation of the national project of the Ministry of Science and Technological Development (No. 143040) and the Ministry of Education, Science and Technological Development (No. 173025), as well as three international projects entitled: “GLOBAQUA (Managing the Effects of Multiple Stressors on Aquatic Ecosystems Under Water Scarcity)”, “Inventory of grayling and trout in Bosnia and Herzegovina and the Republic of Serbia” and “CLINEinBIOTa” (#HRZZ IP-06-2016). In the course of her research, she published 30 scientific papers indexed in the WoS core collection, and has a SCOPUS Hirsch Index $h = 7$ and the number of heterocitations: 155.

Supervisor 2 information

Prof. Marina Piria, PhD

Department of Fisheries, Apiculture, Wildlife management and special Zoology

University of Zagreb, Faculty of Agriculture

Svetošimunska cesta 25, 10000, Zagreb

e-mail: mpiria@agr.hr

Marina Piria was born on September 22, 1972 in Zagreb. At the Faculty of Agriculture. In 1997, she defended her graduation thesis at the University of Zagreb, and in 2003 she completed her master's degree at the same faculty. In 2007, she defended her doctoral dissertation. Since 1998, she has been employed at the Department of Fisheries, Beekeeping, Hunting and Special Zoology at the Faculty of Agriculture, University of Zagreb. In 2008, she was elected as an Assistant Professor, in 2012 as an Associate Professor, and in 2017 as a Full Professor. She is the leader of the Limnology and Oceanology Ichthyology module at the Fisheries and Hunting graduate study. As part of the ERASMUS+ student exchange, she introduced the Limnology and Oceanology module in English, and in 2018 she also took over the Ichthyology module. Since 2018, she has been coordinating the Aquatic ecosystems and biodiversity module at the graduate study of the Faculty of Agriculture, Environment, agriculture and resource management (INTER-EnAgro). She founded the module Energy production from aquaculture and fisheries on the graduate study Renewable energy sources and waste management in agriculture, which is carried out from the academic year 2018/19. She is the leader of module the Biodiversity of the Adriatic and inland waters, and an associate at the module Fisheries and module Invertebrate Cultivation. She is the head of modules the Hydrobiology and Water Protection in Fisheries, Aquatic Invertebrates and Freshwater Fishing at the specialized post-graduate course in Fisheries, and leads the module of Fishing Research Methods in Open Waters at the PhD course in Agricultural Science. From 2015-2020, she was the national leader of the EU FP7 project, and she led two other international projects, one with China and the other with Montenegro. She was a collaborator on 5 international and over 20 domestic projects. In 2017, she received an award for a particularly valuable contribution to the Faculty for the best scientific paper published in the previous calendar year in a journal with the highest five-year impact factor according to the Journal Citation Reports. As the main author or co-author, she has published over 200 publications, of which 68 works are from group A1, 31 from group A2 and 21 from group A3. Other publications refer to professional papers, professional studies and congress abstracts.

Acknowledgments

“Per aspera ad astra”

Svima vama koji ste bili prisutni tijekom ove uzbudljive avanture zvane “Cotutelle” u ostvarivanju uspješne suradnje između Biološkog fakulteta Sveučilišta u Beogradu i Poljoprivrednog fakulteta Sveučilišta u Zagrebu, izražavam veliku zahvalnost.

Prije svega želim zahvaliti svojim mentorima doc. dr sc. Ani Marić i prof. dr sc. Marini Piria na velikoj pomoći pri izradi ove doktorske disertacije. Zahvaljujem na pružanju znanja o laboratorijskim tehnikama i metodama molekularne biologije i morfologije, obradi podataka i interpretaciji rezultata. Hvala vam na svim konstruktivnim savjetima i strpljenju da ova doktorska disertacija ugleda svjetlo dana.

Hvala članovima povjerenstva koji su odvojili vrijeme za čitanje ove doktorske disertacije i svojim prijedlozima pomogli u njenom konačnom oblikovanju.

Hvala prof. dr sc. Ivani Maguire što je omogućila nastanak ove doktorske disertacije kao rezultat istraživanja u okviru projekta kojemu je bila voditeljica, kao i za sve korisne komentare i kritike koje mi je uputila tijekom pisanja publikacija i same disertacije.

Veliku zahvalnost dugujem kolegi mag. ing. agr. Ivanu Špeliću na pomoći tijekom terenskog rada, kao i u morfometrijskim analizama bez kojih ova doktorska disertacija ne bi bila potpuna.

Hvala prof. dr sc. Veri Nikolić što je odgovorila na sva moja pitanja i poticala me tijekom pisanja doktorske disertacije i prevladavanja brojnih administrativnih problema.

Zahvaljujem kolegama dr Jeleni Karanović, dr Milošu Brkušaninu i dr Jovanu Pešoviću iz Centra za humanu molekularnu genetiku, na čelu sa prof. dr sc. Dušankom Savić-Pavićević, na uloženom vremenu i ogromnom strpljenju tijekom rada u njihovom laboratoriju i analize rezultata.

Poseban dio ove zahvalnice upućujem prof. dr sc. Predragu Simonoviću, mom profesoru i šefu. Hvala Vam na prilici da budem dio Vašeg tima u Centru za genotipizaciju ribljih resursa. Hvala Vam na nesebičnom dijeljenju znanja i motivacijI. Hvala Vam na iskrenim savjetima i smjernicama za dosadašnji i budući znanstveno-istraživački rad. Hvala Vam na trudu koji ste ulažili da ustrajem na ovom putu i poštovanju koje ste mi iskazali kao studentu, kandidatu i kolegi.

Na kraju, ogromnu zahvalnost dugujem svojoj obitelji koja uvijek vjeruje u mene čak i kada ja u sebe sumnjam. Hvala mojim roditeljima na podršci, razumijevanju, svim odricanjima i brizi tijekom mog odrastanja i školovanja. Zbog vas sam danas ovo što jesam i zato ovu doktorsku disertaciju posvećujem vama. Hvala vam!

Biljana, hvala ti što si uvijek tu, za sve.

Marko, hvala ti za ljubav koja je moj vjetar u leđa. S tobom sve ima smisla.

Alekseju i Aleksandri...

The research presented in this dissertation was conducted as part of the scientific project **“Climate change and invasive species – determining the impact on the biodiversity of native freshwater crayfish and trout and their conservation (CLINEinBIota)”** (project no. IP-06-2016) funded by the Croatian Science Foundation in the period from 01 March 2017 to 28 February 2021 and led by Prof. Ivana Maguire, PhD.



SUMMARY

Genetic diversity of brown trout (*Salmo trutta* L., 1758) of the Danube basin on the territory of Croatia

To study the complex relationships of genera and species within the family Salmonidae, most research are based on molecular methods. However, morphometric methods are an important part of research and in combination with molecular methods can provide more complete results on the taxonomy, systematics and phylogeny of salmonid species. Brown trout is certainly the most attractive among them, and previous studies has shown that it represents a very variable species, both morphologically and genetically. This is evidenced by the existence of eight phylogenetic lineages within this species: Danube (DA), Atlantic (AT), Mediterranean (ME), *marmoratus* (MA), Adriatic (AD), Tigris, Duero and Dades. An exceptional diversity of native geographically specific populations is found in the Balkan Peninsula. Previous studies have shown that the uncontrolled introduction of non-native lineages in this area has threatened the status of these populations. In this research, 15 populations in the Danube basin of the central-western and eastern part of Croatia were analyzed. One of the analyzed populations was from the fish farm "Vrabac". To determine the population structure of brown trout, as well as the degree of introgression of non-native genetic material, three molecular markers were used: the control region of mitochondrial DNA, the locus of the nuclear gene L-lactate dehydrogenase and eight microsatellite loci. Additionally, the method of geometric morphometry was used to determine variations in body shape between native and introduced lineages, and their hybrids. Two phylogenetic lineages (DA and AT) and a total of four haplotypes (Da1, Da2, Da22 and At1) were identified in the analyzed populations. Among the haplotypes, only Da1 is defined as native. The biggest threat to the indigenous stock is represented by the introduced individuals of the AT lineage, and the hybridization between AT and DA individuals that was established in all analyzed natural watercourses. The presence of non-native individuals most likely originates from imported, farmed and uniform populations of brown trout. As a possible confirmation of this conclusion are the results of geometric morphometry that showed the least variation in body shape in Atlantic brown trout individuals from the "Vrabac" fish farm and those found in natural watercourses.

Key words: control region, microsatellites, genetic diversity, stocking, Croatia, conservation

EXTENDED SUMMARY

Genetic diversity of brown trout (*Salmo trutta* L., 1758) of the Danube basin on the territory of Croatia

Brown trout is an extremely morphologically and genetically variable species, whose taxonomic status has often changed. Today, eight phylogenetic lineages are known, which are defined as a complex of the species *Salmo* cf. *trutta* – Danubian (DA), Atlantic (AT), Mediterranean (ME), *marmoratus* (MA), Adriatic (AD), Tigris, Duero and Dades. The Western Balkans is an area characterized by the greatest phenotypic and genotypic diversity of trout populations, and a large part of the internal territory belongs to the Black Sea basin, where the Danubian Da1 haplotype is native. Numerous studies of brown trout populations in this area have shown that their genetic diversity has been deteriorated by the introduction of the non-native Atlantic phylogenetic lineage, but also non-native Danubian haplotypes. Breeding of allochthonous lineages and stocking of streams attractive for angling in the Western Balkans has a long history. Research of the genetic structure of farmed populations is not legally regulated, although these populations are often the only available material for stocking. The rivers of the Danube basin in Croatia have been poorly researched in terms of the genetic diversity of brown trout populations. Therefore, the aim of this research was to examine the genetic structure of the populations, their status and the influence of allochthonous lineages on their survival.

Fifteen populations in the Danube basin of the central-western and eastern part of Croatia were analyzed. The molecular markers used in this research were: control region of mitochondrial DNA, the L-lactate dehydrogenase nuclear gene locus and eight microsatellite loci. Amplification of the control region was done using appropriate primers, and the obtained sequences were compared with known sequences from previous research in other areas. Restriction analysis of the sequenced L-lactate dehydrogenase locus was performed to assess hybridization between different phylogenetic lineages. Analysis of eight microsatellite loci determined the structure of brown trout populations, as well as the degree of introgression of allochthonous genetic material. Morphometric analysis was performed using the method of geometric morphometry in order to determine variations in body shape between autochthonous and allochthonous lineages, as well as their hybrids.

Sequencing the control region of mitochondrial DNA revealed four haplotypes, three of which belong to the Danubian and one to the Atlantic phylogenetic lineage. Only one haplotype (Da1) is considered autochthonous for the researched area. Two haplotypes were described for the first time – Da1f in the Jankovac Stream and Da1g in the River Toplica. Other brown trout haplotypes (Da2, Da22 and At1) most likely entered natural watercourses through uncontrolled stocking from fish farm stocks. Hybrids of the Danubian and Atlantic phylogenetic lineages were identified in all researched rivers, except in the “Vrabac” fish farm where all individuals were “pure” Atlantic. The analysis of microsatellite loci revealed overlapping between populations, confirming a long history of introduction with non-native genetic material, which most likely originates from imported and farmed individuals of the Atlantic phylogenetic lineage. Potential confirmation of the origin of Atlantic brown trout was presented by additional morphometric analysis, which showed the least variation in body shape in Atlantic individuals from the “Vrabac” fish farm and those found in natural watercourses. A clear differentiation in body shape was also established between individuals of the Atlantic lineage on the one side and the Danubian lineage and hybrids on the other. The biggest differences were observed in body height, head length and eye size. The

morphological differences between the Danubian lineage and hybrids were not statistically significant.

The results of this research showed that the autochthonous populations of brown trout in the rivers of the Danube basin in Croatia are seriously threatened. The main reason is uncontrolled stocking with inadequate material, which is available in fish farms and consists mainly of imported trout of the Atlantic phylogenetic lineage. Knowing the structure of wild and farmed populations is extremely important for proposing and implementing conservation measures, in order to prevent the further disappearance of the unique gene pool of brown trout.

Key words: control region, microsatellites, genetic diversity, stocking, Croatia, conservation

PROŠIRENI SAŽETAK

Genetička struktura populacija potočne pastrmke (*Salmo trutta*, L., 1758) u dunavskom slivu Hrvatske

Potočna pastrmka predstavlja izuzetno morfološki i genetički varijabilnu vrstu čiji se taksonomski status često menjao. Danas je poznato osam filogenetskih linija koje su definisane kao kompleks vrste *Salmo cf. trutta* – dunavska (DA), atlantska (AT), mediteranska (ME), *marmoratus* (MA), jadranska (AD), Tigris, Duero i Dades. Zapadni Balkan je oblast koju odlikuje najveći fenotipski i genotipski diverzitet pastrmskih populacija, a veliki deo unutrašnje teritorije pripada crnomorskom slivu u kojem je nativan dunavski Da1 haplotip. Brojna istraživanja populacija potočne pastrmke na ovom prostoru pokazala su da je njihov genetički diverzitet narušen introdukcijom alohtone atlantske filogenetske linije, ali i nenativnih dunavskih haplotipova. Uzgoj alohtonih linija i poribljavanje ribolovno atraktivnih reka na Zapadnom Balkanu ima dugu istoriju. Ispitivanje genetičke strukture gajenih populacija nije zakonski regulisano, iako su ove populacije najčešće jedini dostupni materijal za poribljavanje. Reke dunavskog sliva u Hrvatskoj slabo su istražene s aspekta genetičkog diverziteta populacija potočne pastrmke i zato je cilj ovog istraživanja bio ispitivanje genetičke strukture populacija, njihovog statusa i uticaja alohtonih linija na njihov opstanak.

Analizirano je 15 populacija u dunavskom slivu centralno-zapadnog i istočnog dela Hrvatske. Molekularni markeri korišćeni u ovom istraživanju bili su: kontrolni region mitohondrijske DNK, lokus jedarnog gena L-laktat dehidrogenaze i osam mikrosatelitskih lokusa. Amplifikacija kontrolnog regiona urađena je upotrebom odgovarajućih prajmera, a dobijene sekvence upoređene su sa poznatim sekvencama iz prethodnih istraživanja na drugim područjima. Restrikcijom analizom sekvenciranog lokusa L-laktat dehidrogenaze procenjeno je ukrštanje između različitih filogenetskih linija. Analizom osam mikrosatelitskih lokusa utvrđena je struktura populacija potočne pastrmke, kao i stepen introgresije alohtonog genetičkog materijala u autohtoni. Morfometrijske analize urađene su metodom geometrijske morfometrije kako bi se utvrdile varijacije u obliku tela između autohtonih i alohtonih linija, ali i njihovih hibrida.

Sekvenciranjem je identifikovano četiri haplotipova, od kojih tri pripadaju dunavskoj, a jedan atlantskoj filogenetskoj liniji. Samo jedan haplotip (Da1) smatra se autohtonim za istraženo područje. Dva haplotipa opisana su prvi put – Da1f na lokalitetu Jankovac-potok i Da1g u reci Toplica. Ostali haplotipovi potočne pastrmke (Da2, Da22 i At1) najverovatnije su dospeli u prirodne vodotokove nekontrolisanim poribljavanjem iz ribnjačkih populacija. Hibridi dunavske i atlantske filogenetske linije identifikovani su u svim istraženim rekama, osim u ribnjaku „Vrabac” gde su sve jedinke „čiste” atlantske. Analizom mikrosatelitskih lokusa utvrđena je velika izmešanost među populacijama, potvrđujući dugu istoriju introdukcije nenativnim genetičkim materijalom, koji najverovatnije potiče iz uvezenih i gajenih jedinki atlantske filogenetske linije. Potencijalna potvrda o poreklu atlantskih pastrmki predstavljena je dodatnim morfometrijskim analizama, koje su Takođe je utvrđena jasna diferencijacija u obliku tela između jedinki atlantske linije s jedne strane i dunavske linije i hibrida s druge strane. Najveće razlike uočene su u visini tela, dužini glave i veličini očiju. Morfološke razlike između dunavske linije i hibrida nisu bile statistički značajne.

Rezultati ovog istraživanja pokazali su da su autohtone populacije potočne pastrmke u rekama dunavskog sliva na području Hrvatske ugrožene. Glavni razlog je nekontrolisano poribljavanje neadekvatnim materijalom, koji je dostupan u ribnjacima i čine ga uglavnom uvezene pastrmke atlantske filogenetske linije. Poznavanje strukture divljih i gajenih

populacija od izuzetnog je značaja za predlaganje i implementaciju konzervacionih mera, kako bi se sprečilo dalje nestajanje jedinstvenog autohtonog genofonda potočne pastrmke.

Ključne reči: kontrolna regija, mikrosateliti, genetički diverzitet, poribljavanje, Hrvatska, konzervacija

PROŠIRENI SAŽETAK

Genetska raznolikost potočne pastrve (*Salmo trutta* L., 1758) dunavskog slijeva na području Hrvatske

Potočna pastrva predstavlja izuzetno morfološki i genetički varijabilnu vrstu, čiji se taksonomski status često mijenjao. Danas je poznato osam filogenetskih linija koje su definirane kao kompleks vrste *Salmo* cf. *trutta* – dunavska (DA), atlantska (AT), mediteranska (ME), *marmoratus* (MA), jadranska (AD), Tigris, Duero i Dades. Zapadni Balkan je područje na kojem se nalazi najveća fenotipska i genotipska raznolikost pastrvskih populacija, a posebno se ističe crnomorski slijev i nativan dunavski Da1 haplotip. Brojna istraživanja populacija potočne pastrve na ovom prostoru pokazala su da je njihova genetska raznolikost narušena unosom strane atlantske filogenetske linije, ali i prenesenim dunavskim haplotipovima. Uzgoj stranih linija i poribljavanje ribolovno atraktivnih vodotoka na Zapadnom Balkanu ima dugu povijest. Istraživanje genetske strukture uzgajanih populacija nije zakonski reguliran, iako su strane populacije najčešće jedini dostupni materijal za poribljavanje. Rijeke dunavskog slijeva u Hrvatskoj slabo su istražene iz aspekta genetske raznolikosti populacija potočne pastrve i zato je cilj ovog istraživanja bio utvrditi genetsku strukturu populacija, njihov status i utjecaj stranih linija na njihov opstanak.

Analizirano je 15 populacija u dunavskom slijevu centralno-zapadnog i istočnog područja Hrvatske. Molekularni markeri korišteni u ovom istraživanju su: kontrolna regija mitohondrijske DNA, L-laktat dehidrogenaze (LDH-C*) i osam mikrosatelitskih lokusa. Amplifikacija kontrolne regije urađena je upotrebom odgovarajućih prajmera, a sekvence su uspoređene sa poznatim sekvencama iz prethodnih istraživanja na drugim područjima. Restriksijskom analizom sekvenciranog lokusa LDH-C* procijenjeno je križanje između različitih filogenetskih linija. Analizom osam mikrosatelitskih lokusa utvrđena je struktura populacija potočne pastrmke, kao i stupanj introgresije stranog genetičkog materijala kako bi se utvrdila varijacija u obliku tijela između nativnih i stranih linija, te njihovih hibrida korištena je metoda geometrijske morfometrije.

Sekvenciranjem je utvrđeno četiri haplotipa, od kojih tri pripadaju dunavskoj, a jedan atlantskoj filogenetskoj liniji. Samo jedan haplotip (Da1) smatra se nativnim za istraženo područje. Dva haplotipa opisana su prvi put – Da1f na lokaciji Jankovac-potok i Da1g u rijeci Toplica. Ostali haplotipovi potočne pastrmke (Da2, Da22 i At1) vjerojatno su uneseni u prirodne vodotoke nekontroliranim poribljavanjem ribnjačkih populacija. Hibridi dunavske i atlantske filogenetske linije utvrđeni su u svim istraženim rijekama, osim u ribnjaku „Vrabac” gdje su sve uzgajane jedinke „čiste” atlantske linije. Analizom mikrosatelitskih lokusa utvrđena je velika izmiješanost među populacijama, potvrđujući dugu povijest unosa stranog genetskog materijala, koji nevjerojatnije potječe od uvezenih i uzgajanih jedinki atlantske filogenetske linije. Porijeklo atlantskih jedinki pastrva potvrđeno je morfometrijskim analizama, a one su pokazale najmanje varijacije u obliku tijela između jedinki iz ribnjaka „Vrabac” i atlantskih jedinki uzorkovanih iz prirodnih vodotoka. Osim toga, utvrđena je jasna varijacija u obliku tijela između jedinki atlantske linije i dunavske linije. Najveće razlike uočene su u visini tijela, dužini glave i veličini očiju. Jedinke hibrida su bile sličnije dunavskim linijama te njihove morfološke razlike nisu bile statistički značajne.

Rezultati ovog istraživanja pokazali su da su autohtone populacije potočne pastrmke u rijekama dunavskog sliva na području Hrvatske ugrožene. Glavni razlog je nekontrolirano poribljavanje neadekvatnim genetičkim materijalom dostupnim u ribnjacima, a čine ga uglavnom unesene pastrve atlantske filogenetske linije. Poznavanje strukture divljih i

uzgajanih populacija od izuzetnog je značaja za predlaganje i implementaciju konzervacijskih mjera, kako bi se spriječilo buduće nestajanje jedinstvenog genofonda potočne pastrve.

Ključne reči: kontrolna regija, mikrosateliti, genetska raznolikost, poribljavanje, Hrvatska, konzervacija

Contents

1. INTRODUCTION	1
1.1. Research hypotheses and objectives	3
2. OVERVIEW OF FORMER RESEARCH	4
2.1. Species <i>Salmo trutta</i>	4
2.1.1. Biological and ecological characteristics.....	4
2.1.2. Taxonomy, systematics, and phylogeny of salmonids.....	6
2.1.3. Introduction of non-native lineages and conservation status of native lineages of <i>Salmo cf. trutta</i>	11
2.2. Genetic and morphological methods in the study of fish populations	13
2.2.1. Genetic markers of the research.....	15
2.2.2. Geometric morphometrics	19
2.3. Research area	21
2.3.1. Gorski Kotar.....	21
2.3.2. The Žumberak-Samoborsko gorje Nature Park.....	22
2.3.3. Papuk Nature Park	24
3. MATERIAL AND METHODS	27
3.1. Material sampling	27
3.2. Genetic analyses	28
3.2.1. DNA extraction.....	29
3.2.2. Amplification	29
3.2.3. Electrophoresis on agarose gel.....	31
3.2.4. Genetic data analysis program	33
3.3. Morphometric analyses	34
3.3.1. Geometric morphometrics methods.....	34
4. RESULTS	37
4.1. Sequence analysis of the CR mtDNA	37
4.2. Analysis of the nuclear LDH-C1* locus	43
4.3. Analysis of microsatellite loci	44
4.4. Analysis of morphological variations of brown trout lineages	56
5. DISCUSSION	63
6. CONCLUSIONS	73

7. REFERENCES	75
Autobiography	96
APPENDICES	99
Appendix A.	99
Appendix B.	100

Abbreviations

A – Adenine

ATP – Adenosine triphosphate

bp – base pair

C – Cytosine

DNA – Deoxyribonucleic acid

dNTP – Deoxynucleoside triphosphate

EDTA – ethylene-diamine-tetra-acetic acid

G – Guanine

Kbp – kilobase pair (1000 base pairs)

mtDNA – mitochondrial DNA

PCR – Polymerase Chain Reaction

pH – measure of hydrogen ion concentration

RFLP – Restriction Fragment Length Polymorphism

RNA – Ribonucleic acid

rRNA – ribosomal RNA

SDS – sodium dodecyl sulphate

T – Thymine

Taq DNA – highly thermostable DNA polymerase from the thermophilic bacterium *Thermus aquaticus*

TBE – buffer solution containing a mixture of Tris base, boric acid and EDTA

TEN – buffer solution containing a mixture of Tris base, sodium chloride and EDTA

Tris – 2-amino-2-hydroxymethyl-propane-1,3-diol

tRNA – transfer RNA

List of tables

Table 1. Number of individuals by sampling location and type of analysis.	28
Table 2. Composition of the PCR reaction mixture for CR mtDNA.	31
Table 3. Composition of the PCR reaction mixture for the LDH-C* locus.	31
Table 4. Final concentration of primers used in duplex reactions.	32
Table 5. CR mtDNA haplotypes of brown trout in researched rivers of Croatia. n – number of individuals, DA – Danubian lineage, AT – Atlantic lineage.	37
Table 6. Polymorphic sites of CR mtDNA sequences of brown trout haplotypes. Novel haplotypes are marked with asterisk (*). Dots (.) indicate the same nucleotide as in first sequence and slash (/) gaps in sequence.	39
Table 7. Pairwise distance values between selected CR mtDNA haplotypes of brown trout. Novel haplotypes are represented with asterisk (*).	41
Table 8. Analysis of molecular variance (AMOVA) among and within populations of brown trout from different drainages. df – the degrees of freedom in the source, F_{ST} – fixation index, V_a – among population variance, V_b – within population variance.	42
Table 9. Significant differences (distances) between populations of brown trout from different drainages. KU – Kupa, LJ – Lička Jesenica, S – Sava, D – Drava, G – gene diversity, π – nucleotide diversity, F_{ST} values are given under diagonal, F_{ST} p-values are given above diagonal ($p < 0.05$ are shown in bold).	42
Table 10. Proportion of randomizations that gave a smaller F_{IS} values than the observed at the analyzed microsatellite loci. LE – Mala Lešnica, CZ – Curak, ČA – Čabranka, JA – Jasenak, BP – Bresni potok, SL – Slapnica, KČ – Kupčina, KČR – “Vrabac” fish farm, LJ – Lička Jesenica, VE – Veličanka, OR – Orłjava, TO – Toplica, JP – Jankovac-Stream, JJ – Jankovac-Lake, BR – Brzaja.	45
Table 11. Average heterozygosity of microsatellite loci in the studied populations. H_{exp} – expected heterozygosity, $H_{n.b.}$ – objective heterozygosity, $H_{obs.}$ – observed heterozygosity, SD – standard deviation, p – probability, \bar{A}_n – average number of alleles per loci, LE – Mala Lešnica, CZ – Curak, ČA – Čabranka, JA – Jasenak, BP – Bresni potok, SL – Slapnica, KČ – Kupčina, KČR – “Vrabac” fish farm, LJ – Lička Jesenica, VE – Veličanka, OR – Orłjava, TO – Toplica, JP – Jankovac-Stream, JJ – Jankovac-Lake, BR – Brzaja.	46
Table 12. Population average pairwise differences (F_{ST}). The average number of pairwise differences between populations are shown above diagonal, and the average number of pairwise differences within population are shown as diagonal elements. VE – Veličanka, OR	

– Orłjava, LE – Mala Lešnica, TO – Toplica, LJ – Lička Jesenica, SL – Slapnica, JA – Jasenak, JP – Jankovac-Stream, JJ – Jankovac-lake, BR – Bresni potok, CZ – Curak, ČA – Čabranka, KČ – Kupčina, KČR – “Vrabac” fish farm, BP – Brzaja 47

Table 13. Genetic distances for populations pairs shown by fixation index values (F_{ST}) are shown under diagonal, and estimated gene flow values (Nm) are shown above diagonal. VE – Veličanka, OR – Orłjava, LE – Mala Lešnica, TO – Toplica, LJ – Lička Jesenica, SL – Slapnica, JA – Jasenak, JP – Jankovac-Stream, JJ – Jankovac-Lake, BR – Bresni potok, CZ – Curak, ČA – Čabranka, KČ – Kupčina, KČR – “Vrabac” fish farm, BP – Brzaja..... 48

Table 14. Nei’s distances values between pairs of populations. VE – Veličanka, OR – Orłjava, LE – Mala Lešnica, TO – Toplica, LJ – Lička Jesenica, SL – Slapnica, JA – Jasenak, JP – Jankovac-Stream, JJ – Jankovac-lake, BR – Bresni potok, CZ – Curak, ČA – Čabranka, KČ – Kupčina, KČR – “Vrabac” fish farm, BP – Brzaja..... 49

Table 15. Wilcoxon test results based on two mutation models – TPM and SMM. Bold values are significance lower than 0.05. D – heterozygosity deficiency, E – heterozygosity excess, VE – Veličanka, OR – Orłjava, LE – Mala Lešnica, TO – Toplica, LJ – Lička Jesenica, SL – Slapnica, JA – Jasenak, JP – Jankovac-Stream, JJ – Jankovac-Lake, BR – Brzaja, CZ – Curak, ČA – Čabranka, KČ – Kupčina, KČR – “Vrabac” fish farm, BP – Bresni potok..... 55

Table 16. Procrustes ANOVA results for the assessment of digitization error of variation for both centroid size and shape in 20 randomly selected individuals. SS – sum of squares, MS – mean squares, df – degrees of freedom, F – F ratio, p – probability..... 56

Table 17. Procrustes ANOVA results for shape variation assessment in 90 individuals. SS – sum of squares, MS – mean squares, df – degrees of freedom, F – F ratio, p – probability 56

Table 18. Results of the cross-validation test in DFA for the compared groups of trout. Numbers in brackets represent the correctly assigned individuals in relation to the total number of compared individuals. AT – Atlantic lineage, DA – Danubian lineage, Hy – hybrids..... 58

Table 19. Procrustes distances and permutation test p-values shown for pairs of groups. CVA – Canonical Variate Analysis, DFA – Discriminant Function Analysis..... 59

Table 20. Pairwise comparison of Procrustes variance between groups. Values of the observed pairwise absolute differences (distances) among group are shown under diagonale. p-values associated with pairwise differences are shown above diagonale. AT – Atlantic lineage, DA – Danubian lineage, Hy – hybrids, group-specific values show variance within each lineage separately 59

List of figures

Figure 1. The typical brown trout (<i>Salmo trutta</i>) specimen.	4
Figure 2. Systematics of the family Salmonidae (Nelson, 1994).	7
Figure 3. A map of the <i>Salmo salar</i> mitochondrial genome (Fridjonsson et al., 2011).	16
Figure 4. The Curak River and small hydroelectric power plant “Zeleni vir”.	22
Figure 5. The Slapnica River.	24
Figure 6. The Jankovac River.	25
Figure 7. The first flow-through lake created on the Jankovac River as part of the “Bršljan-Jankovac” picnic area.	25
Figure 8. The Orłjava River.	26
Figure 9. The Brzaja River.	26
Figure 10. Map of sampling sites of brown trout in the Danube River basin of Croatia. Gorski Kotar region: 1 – Mala Lešnica, 2 – Curak, 3 – Čabranka, 4 – Bresni Potok, 5 – Jasenak, 6 – Lička Jesenica; Žumberak region: 7 – Kupčina and “Vrabac” fish farm (marked with a red circle), 8 – Slapnica; Mt. Papuk region: 9 – Orłjava, 10 – Toplica, 11 – Brzaja, 12 – Jankovac-Stream, 13 – Jankovac-Lake, 14 – Veličanka.	27
Figure 11. Sample preparation for digitization using point-marking. Points 1-9 represent fixed landmarks, points 10-19 represent semilandmarks and 20-25 are helper points (Špelić et al., 2021).	35
Figure 12. Incidence of haplotypes in investigated rivers of the Danube basin in Croatia.	38
Figure 13. Maximum Likelihood rooted bootstrap tree showing the relationship between novel haplotypes (*) and selected CR mtDNA haplotypes of brown trout from the Danube basin and one from the AT phylogenetic lineage (as an outgroup). Numbers indicate bootstrap probabilities.	40
Figure 14. Neighbor-Joining rooted bootstrap tree showing the relationship between novel haplotypes (*) and selected CR mtDNA haplotypes of brown trout from the Danube basin and one from the AT phylogenetic lineage (as an outgroup). Numbers indicate bootstrap probabilities.	40
Figure 15. Result of restriction analysis of samples from the Kupčina River.	43
Figure 16. Result of restriction analysis of samples from the “Vrabac” fish farm.	43
Figure 17. CLUSTER analysis of matrix distances of 15 investigated populations according to Nei's distances. VE – Veličanka, OR – Orłjava, LE – Mala Lešnica, TO – Toplica, LJ – Lička Jesenica, SL – Slapnica, JA – Jasenak, JP – Jankovac-Stream, JJ – Jankovac-lake, BR –	

Bresni potok, CZ – Curak, ČA – Čabranka, KČ – Kupčina, KČR – “Vrabac” fish farm, BP – Brzaja 50

Figure 18. Clustering of populations using the Neighbor-Joining rooted bootstrap tree method according to DAS values. VE – Veličanka, OR – Orłjava, LE – Mala Lešnica, TO – Toplica, LJ – Lička Jesenica, SL – Slapnica, JA – Jasenak, JP – Jankovac-Stream, JJ – Jankovac-lake, BR – Bresni potok, CZ – Curak, ČA – Čabranka, KČ – Kupčina, KČR – “Vrabac” fish farm, BP – Brzaja..... 51

Figure 19. Corresponding factor analysis of 15 analyzed populations according to factors: **A)** 1/2, **B)** 2/3 and **C)** 1/3..... 52

Figure 20. Grouping of individuals according to DAS values. VE – Veličanka, OR – Orłjava, LE – Mala Lešnica, TO – Toplica, LJ – Lička Jesenica, SL – Slapnica, JA – Jasenak, JP – Jankovac-Stream, JJ – Jankovac-Lake, BR – Brzaja, CZ – Curak, ČA – Čabranka, KČ – Kupčina, KČR – “Vrabac” fish farm, BP – Bresni potok 53

Figure 21. **A)** Value of ΔK and **B)** population structuring. VE – Veličanka, OR – Orłjava, LE – Mala Lešnica, TO – Toplica, LJ – Lička Jesenica, SL – Slapnica, JA – Jasenak, JP – Jankovac-Stream, JJ – Jankovac-Lake, BR – Brzaja, CZ – Curak, ČA – Čabranka, KČ – Kupčina, KČR – “Vrabac” fish farm, BP – Bresni potok 54

Figure 22. Scatterplot of the first two canonical variate axes of CVA depicting trout shape variation, including mean ellipses. Wireframe graphs with 19 marked landmarks represent shape change along the first and second CV axes, from negative to positive extremes. Light blue outlines represent the average shape and dark blue outlines represent extreme shape changes. At – Atlantic lineage, Da – Danubian lineage, Hy – hybrids 57

Figure 23. Shape variation between pairs of groups according to DFA. Light blue outline represents average shape of first mentioned lineage and dark blue outline represents average shape of the second lineage. At – Atlantic lineage, Da – Danubian lineage, Hy – hybrids..... 58

Figure 24. Scatterplot of the first two principal components of PCA depicting trout shape variation within Atlantic lineage. Wireframe graphs with 19 marked landmarks represent shape change along the first and second principal components, from negative to positive end. Light blue outlines represent the average shape and dark blue outlines represent shape changes. 60

Figure 25. Scatterplot of the first two principal components of PCA depicting trout shape variation within Danubian lineage. Wireframe graphs with 19 marked landmarks represent shape change along the first and second principal components, from negative to positive end.

Light blue outlines represent the average shape and dark blue outlines represent shape changes. 61

Figure 26. Scatterplot of the first two principal components of PCA depicting trout shape variation within hybrid group. Wireframe graphs with 19 marked landmarks represent shape change along the first and second principal components, from negative to positive end. Light blue outlines represent the average shape and dark blue outlines represent shape changes. ... 62

1. INTRODUCTION

Brown trout is an extremely morphologically and genetically variable species, which caused the existence of many geographically specific populations consisting of individuals with characteristic morphological features. Genetic research conducted at the end of the 20th century showed that in addition to obvious morphological variability, trout of a certain geographical area show significant specific similarities at the genetic level as well. The established genetic similarities are not in any way related to ecological forms (described in chapter 2.1.1), but exclusively to the geographical areas (basins) that this species naturally inhabits (Bernatchez et al., 1992; Giuffra et al., 1996; García-Marín et al., 1999; Berrebi et al., 2000; Marić et al., 2006; Tošić et al., 2016; Škraba Jurina et al., 2020). This has been a major problem in terms of its taxonomy, then systematics and phylogeny. Relying only on morphological features, scientists gave this species many different scientific names, varying from about 25 to over 50 (Kottelat and Freyhof, 1997; 2007; Froese and Pauly, 2018). Thus, as many as 15 species within the genus *Salmo* have been described on the Balkan Peninsula: *S. labrax* (Pallas, 1814), *S. marmoratus* (Cuvier, 1829), *S. obtusirostris* (Heckel, 1851), *S. dentex* (Heckel, 1851), *S. ohridanus* (Steindachner, 1892), *S. letnica* (Karaman, 1924), *S. macedonicus* (Karaman, 1924), *S. balcanicus* (Karaman, 1927), *S. taleri* (Karaman, 1933), *S. montenigrinus* (Karaman, 1933), *S. farioides* (Karaman, 1938), *S. peristericus* (Karaman, 1938), *S. zrmanjaensis* (Karaman, 1938), *S. pelagonicus* (Karaman, 1938), *S. visovacensis* (Taler, 1950), *S. lumi* (Poljakov et al., 1958), *S. aphelios* (Kottelat, 1997), *S. lourosensis* (Delling, 2011). The position in systematics of these nominal trout taxon is still highly debatable.

A large number of described *Salmo* species are phylogenetically closely related, so based on many taxonomic reviews and phylogenetic studies, many authors agree that all of them are actually considered as a complex of one species united under the name *Salmo* cf. *trutta* (Bernatchez et al., 1992; Bernatchez, 2001; Simonović et al., 2007; Lo Brutto et al., 2010; Snoj et al., 2010; Meraner et al., 2013; Gratton et al., 2014). Exceptions are *Salmo ohridanus* and *Salmo obtusirostris*, for which there was always a discussion whether they are a distinct genus (or genera) (Razpet et al., 2007; Pustovrh et al., 2014).

As a start to unraveling the rather complicated and confusing phylogeny of *Salmo trutta*, Bernatchez et al. (1992) conducted a study based on genetic analysis of 24 trout populations from the Atlantic, Danubian, Mediterranean and Adriatic basins, including all three forms of this species (*fario*, *lacustris* and *trutta*), as well as *Salmo marmoratus*, *Salmo carpio* and *Salmo macrostigma*. As a genetic marker, they used the sequence of the control region (CR) of mitochondrial DNA (mtDNA). The result of the research was the definition of five phylogenetic lineages (haplogroups) of brown trout, which corresponded to the specific geographic origin of the sample. Five phylogenetic lineages are defined as: Mediterranean (ME), Adriatic (AD), Danubian (DA), Atlantic (AT) and *marmoratus* (MA). A total of 12 haplotypes were described within the defined haplogroups. The definition of phylogenetic lineages was followed by many research on the detection and distribution of brown trout haplogroups and haplotypes throughout Europe, revealing its great genetic diversity. In addition to CR mtDNA, various genetic markers, both mitochondrial and nuclear, were used in order to clarify the classification and perform phylogenetic and phylogeographic studies for species within the genus *Salmo*.

Bernatchez (2001) published a study explaining the allopatric distribution of lineages despite their high dispersal potential. The AT lineage inhabits the Atlantic basin, from Morocco to the White Sea, while the DA lineage dominates in the rivers of the Ponto-Caspian basin. The MA lineage inhabits Southern Europe, limited to a few rivers in Italy, Croatia and Slovenia, which apparently flowed into Adriatic Sea basin during the longest glacial periods. The AD lineage dominates in eastern Mediterranean tributaries and greater diversity is present in populations in the Balkans, suggesting that the AD lineage originated from the Balkan-Anatolian glacial refugium. Finally, the ME lineage is present in rivers flowing into the western Mediterranean Sea, suggesting that it may have originated in this region, from the isolated rivers of southern France that served as glacial refugium. The number of phylogenetic lineages changed at the beginning of the 21st century, so by sequencing the entire CR mtDNA within population of brown trout from the Iberian Peninsula and North Africa, Suárez et al. (2001) defined the endemic Duero (DU) phylogenetic lineage. Bardakci et al. (2006) add a seventh, the Tigris (TI) phylogenetic lineage from northeastern Anatolia, for populations from the Tigris River basin which is later described as a separate species named *Salmo tigridis* (Turan et al. 2011). Snoj et al. (2011) described one more – Dades phylogenetic lineage of brown trout in headwaters of the Dades River and its tributary M'Goun in the High Atlas Mountains of North-West Africa. However, Doadrio et al. (2015) raised the category of Dades trout to the species level naming it *Salmo multipunctatus*. Summarizing the results of a

large number of studies that contributed to the identification of a large number of haplotypes within the eight basic phylogenetic lineages of brown trout, Sanz (2018) provides a general scheme of the *Salmo trutta* species complex. Based on this scheme, haplotypes of brown trout are grouped into three “major” lineages – Mediterranean, Danubian and Atlantic, or nine “minor” lineages – Adriatic (AD), Mediterranean (ME), *marmoratus* (MA) (within the Mediterranean “major” lineage), Danubian Black Sea (DA-BS), East Danubian (DA-ES) (within the Danubian “major” lineage), Atlantic (AT), Duero (DU) (within the Atlantic “major” lineage), Tigris (TI) and Dades (defined as “outline” lineages). Brown trout of all the mentioned lineages are characterized by exceptional variability in external morphology, colour, genetic structure and life history. Also, phylogenetic analyses confirmed the taxonomic positions of *Salmo ohridanus* and *Salmo obtusirostris* as ancestral species that diverged a lot in relation to the *Salmo trutta* species complex.

1.1. Research hypotheses and objectives

Hypotheses set in this research are:

1. The original Danubian phylogenetic lineage of brown trout is present in the rivers and streams of the Danube basin in the area of western-continental and eastern Croatia.
2. The original Danubian lineage of brown trout in the investigated rivers and streams hybridized with the introduced Atlantic phylogenetic lineage of this species.
3. Different phylogenetic lineages differ morphologically.

The objectives of the research are:

1. Determine the genetic structure of brown trout populations in the Danube River basin in the area of western-continental and eastern Croatia using molecular markers – control region of mitochondrial DNA and nuclear DNA (part of the nuclear gene L-lactate dehydrogenase and eight microsatellite loci).
2. Assess the condition of the original stock of brown trout and determine whether hybridization with the introduced Atlantic phylogenetic lineage has occurred.
3. Determine the shape of external morphology between different phylogenetic lineages and their hybrids.

2. OVERVIEW OF FORMER RESEARCH

2.1. Species *Salmo trutta*

2.1.1. Biological and ecological characteristics

The brown trout, *Salmo trutta* Linnaeus, 1758, is a fish that has a spindle-shaped body covered with tiny scales, except for the head. The jaws are strongly developed, with one row of sharp teeth. Teeth are also developed on the vomer. There are 14-17 short, wide gill rakers on the first gill arch (branchiospinae). The lateral line has 112-132 scales. Like all species from the Salmonidae family, behind the dorsal fin and at the dorsal side of the tail, there is an adipose fin. There are 13-16 scales between the lateral line and the base of the adipose fin. The highest body height is at the level of the very beginning of the base of the dorsal fin (Simonović, 2001). The color of the body varies, and it largely depends on the characteristics of the habitat. There are numerous dark, red and/or orange spots on the dorsal and lateral sides of the body, opercula and dorsal fin (Povž et al., 1996) (Figure 1). Brown trout feed on insect larvae and smaller fish (Simonović, 2001). As an adaptation to the carnivorous diet, the stomach is strongly muscular, and the number of pyloric caeca is 40-100.



Figure 1. The typical brown trout (*Salmo trutta*) specimen.

Brown trout spawn in fresh water, in the period November-January. They are iteroparous and spawn at least two to three times during their lifetime (Elliott, 1994). They reach sexual maturity at 2-3 years. Sexual dimorphism exists at the time of spawning, so females have a rounded belly and a red, swollen genital opening, while males have a more elongated skull with a strongly developed hooked lower jaw. They spawn in pairs. The female chooses a place for spawning on gravelly bottom substrate digs to form a redd in which she lays 500 to 30 000 roe, and after fertilization covers them with gravel with her tail (Simonović, 2001; Kottelat and Freyhof, 2007). After spawning, the females leave, while the males stay at the spawning site for some time (Klemetsen et al., 2003). The size of the ripe roe is 4.5 to 5 mm in diameter. The period of development *in ovo* lasts from six to eight weeks, which depends on the temperature of the water. From embryo to adult form, this species goes through several periods of development. Juvenile coloration is a characteristic feature of the species and implies the presence of a dozen dark vertical spots on the sides of the body, which gradually disappear with the age of the individual. After one year, they reach a body length of about 10 cm, and after two years up to 25 cm (Jevtić, 1989). The lifetime of brown trout can be as long as 20 years (Sømme, 1941).

Brown trout is native to the clear, cold, mountain waters of Europe, Near East in Asia and North-Western Africa. It is distributed in the area from northern Norway and the northeastern part of Russia in the north to the Atlas Mountains in North Africa in the south, and from Iceland in the west to the Aral Sea in the east (Behnke, 1986; Elliott, 1994). Apart from rivers, this species is also adapted to life in lakes with clean and cold water, as well as in seas. Because of its adaptation to different environmental conditions, it is known that there are three different ecological forms/morphs of brown – *Salmo trutta* forma *trutta* (sea form), *Salmo trutta* forma *lacustris* (lake form) and *Salmo trutta* forma *fario* (river form). Sea and lake forms are diadromous, and during reproduction, they migrate to rivers. The river form is resident – monodomous, which can undertake smaller or larger migratory movements within its river habitat. Both migratory and resident forms can exist within the same population. Reproductive isolation between them does not exist and they spawn together at the same spawning sites.

Brown trout was introduced in more than 24 countries outside Europe, throughout Asia and Africa, then to Australia, North and South America (Laikre et al., 1999), so it is considered the most widespread freshwater fish.

2.1.2. Taxonomy, systematics, and phylogeny of salmonids

The systematics of the family Salmonidae was often changed, and the biggest disagreements among authors were at the subfamily level, as well as at the genus and species level that exist within the subfamily Salmoninae. The generally accepted classification system implies the existence of three subfamilies within the family Salmonidae – subfam. Coregoninae, subfam. Thymallinae and subfam. Salmoninae (Integrated Taxonomic Information System (ITIS, 2003) (Figure 2). Research indicates that the Salmonidae first appear in the form of a fossil finding of the species *Eosalmo driftwoodensis*, from the Driftwood Creek province in the central part of British Columbia (Canada), which dates from the Middle Eocene. *Eosalmo driftwoodensis* is considered the oldest species that shares characteristics with the subfamilies Salmoninae and Thymallinae and is therefore considered an ancient species that represents an important stage in the evolution of salmonids (McPhail and Strouder, 1997). Among the ancient fossil remains of trout, it is important to note that the one in Croatia was that of *Salmo immigratus* Kramberger, 1891 discovered from the Upper Sarmatian (Miocene) deposits at the locality in the vicinity of Samobor (western Croatia) dated to 13 m.y.a. (Anđelković, 1989).

Based on morphological similarities and differences, during the 20th century, scientists explained the phylogenetic relationships within the subfamily Salmoninae in different ways (Norden, 1961; Vladykov, 1963; Kendall and Behnke, 1984; Dorofeeva, 1989; Starley and Smith, 1993). It is known that the high level of phenotypic plasticity in most species of the family Salmonidae limits the utility of morphological characters in resolving phylogenetic relationships. That is why the use of genetic analyses was necessary for their better understanding and more correct definition. With the use of genetic analyses, there was a change in the classification of genera, and thus also the species within this subfamily. The first extensive genetic studies using allozymes were carried out by Ferguson and Fleming (1983) and Cross (1989), which confirmed the relationship between Atlantic salmon (*Salmo salar*) and brown trout (*Salmo trutta*) within the genus *Salmo*, as well as their distance from other genera. An important example of the reclassification of Salmoninae is the research of Oakley and Phillips (1999), who, based on the growth hormone gene sequence (GH2C), established that the genus *Brachymystax* is a more derived representative of the genus *Hucho*. Thus, the hypothesis of the genus *Brachymystax* as an archaic genus of the subfamily Salmoninae, which was based on morphological analyses by Starley and Smith (1993) was

rejected. The research of Snoj et al (2002) is also highlighted, using cytochrome b (cytb) and control region (CR) as molecular markers, they determined that the genera *Salmothymus* and *Acantholingua* belong to the genus *Salmo* and do not exist as separate genera.

The best-studied genera within the subfamily Salmoninae are *Oncorhynchus*, *Salmo* and *Salvelinus*, and Arctic char (*Salvelinus alpinus*), Atlantic salmon (*Salmo salar*) and brown trout (*Salmo trutta*) represent the most analyzed fish species in science (Klemetsen et al., 2003).

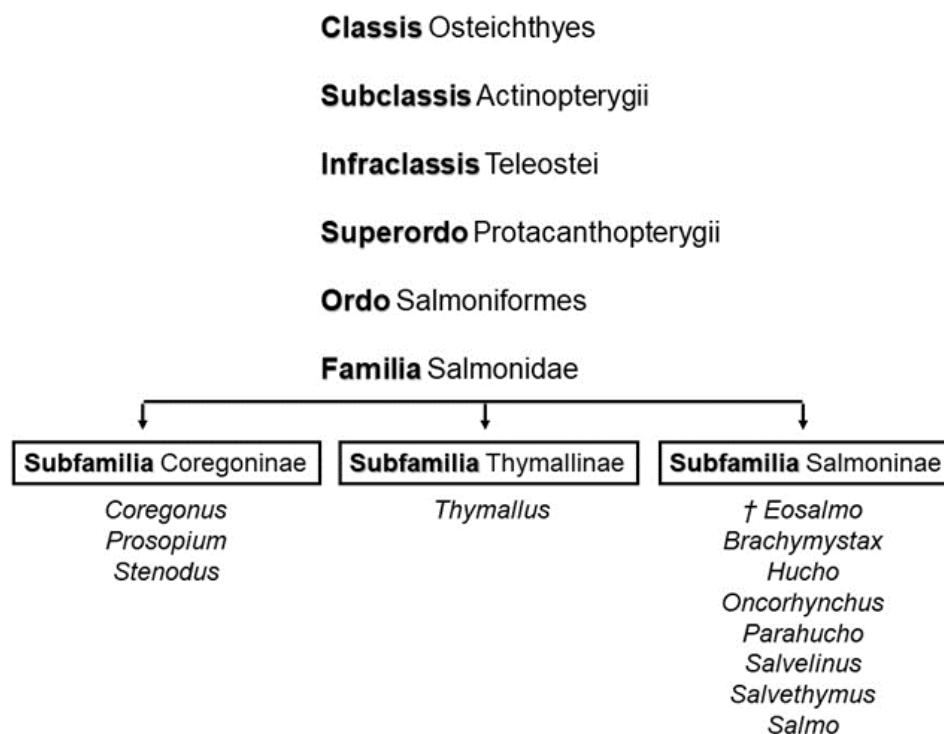

Figure 2. Systematics of the family Salmonidae (Nelson, 1994).

2.1.2.1. The diversity of *Salmo cf. trutta* on the Balkan Peninsula

Evolutionary history of brown trout, i.e., *Salmo cf. trutta* is complex. Research rely on the fact that it was shaped through various geological events, such as glaciations, mountain orogeny, retreat of the sea and changes in rivers and lakes basins (Karaman, 1924; 1927; 1938; Bernatchez et al., 1992; Bernatchez, 2001). Genetic analyses based on the control region of mitochondrial DNA indicated that recent brown trout speciation started 0.5–2.0 million years ago and passed the differentiation during the Pleistocene glaciations that lasted

about 700 000 years (Bernatchez, 2001). Research based on ITS nuclear gene analysis (Presa et al., 2002) and multiple nuclear loci (Pustovrh et al., 2014) indicated that the Atlantic lineage was the first to split-off. In parallel, research based on mtDNA analysis (Weiss et al., 2001; Snoj et al., 2009; Cortey et al., 2009) suggested that the Danubian lineage could be the oldest one and have revealed a sister relationship between the Atlantic and Mediterranean lineages. After the isolation of the Mediterranean lineages, the Atlantic lineage could split from a common ancestor and spread north early in the Pleistocene or late in the Pliocene.

Although it occupies only 5% of the territory of Europe, the Balkan Peninsula is characterized by geomorphological specificities and is considered an extremely rich faunal and floristic area. Therefore, from an ichthyological point of view, it certainly fits into that description, especially of freshwater fish, among which salmonid species are the most numerous. Its western part, the Western Balkans, has a high level of endemism of salmonid genera and species (Behnke, 1973), and Bernatchez (2001) described it as the area of greatest phenotypic diversity among trout populations. As Karaman (1927) explained, the main reason for the isolation of trout populations originating from the Tertiary is the formation of the Dinarid Alps, a mountain massif in southern Europe, which stretches across the western part of the Balkan Peninsula through Slovenia, Croatia, Bosnia and Herzegovina, Serbia and Montenegro. He also suggested that the post-Pleistocene isolation of trout within the basins is a consequence of the refugial nature of the Balkan Peninsula during and after the Quaternary ice ages. The Balkan Peninsula, together with the Iberian and Apennines, is considered a reservoir of diversity of the *Salmo trutta* complex and related species of the genus *Salmo* (Suarez et al., 2001; Snoj et al., 2002; Sušnik et al., 2007). Many populations in these territories arose because of complex evolutionary mechanisms, including occurrences of secondary contact between ancestral lineages, as well as local adaptation of populations (Sanz et al., 2002; Snoj et al., 2008; Vera et al., 2010).

The three main phylogenetic lineages of *Salmo* cf. *trutta* are natively present in the Balkans – Danubian (DA), Adriatic (AD) and *marmoratus* (MA). The Danubian lineage inhabits the northern, eastern and central parts of the Balkan Peninsula, i.e., the Black Sea basin, and the Adriatic lineage inhabits the northwestern and southwestern areas of the region, numerous lotic and some limnetic habitats in the continental area of the Adriatic and Ionian seas' basins (Georgiev, 2003). The *marmoratus* lineage inhabits the narrowest area and

together with *S. obtusirostris* inhabits the Neretva River, close to the Danubian and Adriatic lineages in the Bojana-Drim river system (Bernatchez, 2001).

The rivers of the Western Balkans that belong to the Black Sea basin occupy a considerable territory and are very significant from the aspect of studying the diversity and life history of *Salmo* cf. *trutta* lineages. However, the taxonomic status of brown trout on the Balkan Peninsula is still unclear. Population studies in the Danube River drainage, i.e., Black Sea basin, of the Western Balkans accumulated records about the diversity of the CR mtDNA haplotypes of brown trout species complex. As already has been pointed out, the DA lineage is native to the Danubian drainage, and Da1 is the most widely distributed haplotype. However, studies have shown that in the rivers of the Black Sea basin, in addition to Da1, there are also numerous other haplotypes, not all of which are considered native. Apart from the DA lineage, non-native haplotypes of other phylogenetic lineages are also present in most of the investigated rivers.

Snoj (2004) reported seven DA haplotypes of brown trout in the Danube River drainage of the Western Balkans and their adjacent regions. Among the initial more extensive phylogeographic studies of brown trout populations in the Danube Basin, Marić et al. (2006) reported the presence of eight different DA haplotypes in the rivers of Serbia, among which three newly described – Da*VI, Da*DŽ and Da*Vr. Reconstruction of the phylogeny indicated their ancestral character. In addition to the DA lineage, the presence of one individual carrying AD and one carrying AT haplotypes were recorded.

Jadan et al. (2007) published the presence of the Da2 haplotype in the Gacka River that belongs to the Adriatic Sea basin. Apart from the possible introduction of this lineage in this river, a potential explanation lies in the geological history of the Gacka River as a part of the Danubian drainage, thereby attributing to it a native character, which is debatable. Jadan et al. (2015) studied the diversity of *Salmo* cf. *trutta* in Croatia, but only for the rivers of the Adriatic basin.

Tošić et al. (2014) described a new, native CR mtDNA haplotype of brown trout – Da23c, exclusively present in the Veliki Timok River system in Eastern Serbia. In addition to the newly described one, the presence of the Da2 haplotype is also noted.

Simonović et al. (2017) reported the presence of fifteen DA haplotypes, but also several individuals of AT, AD and MA haplotypes in selected rivers of the Danube River drainage, included a few Croatian samples from the streams draining to the Sava River. It is found that Da1 is the most represented of all haplotypes and that is present in the headwaters of the Kupa River, and the sinking stream Lička Jesenica as a single haplotype. Škraba Jurlina et al. (2017) reported the presence of Da2 and Da22 haplotypes in the Una National Park in the Krka and Una rivers in Bosnia and Herzegovina.

Although *Salmo trutta* is defined as a species complex, Buj et al. (2020) nevertheless reported their research on two species of the genus *Salmo* – *Salmo labrax* and *Salmo trutta*, in the Plitvice Lakes National Park. Using *cytb* and CR mtDNA as molecular markers, they identified 29 new *cytb* haplotypes and 11 CR mtDNA haplotypes, but without a clear definition of whether any of the new haplotypes belong to one of the main phylogenetic lineages expected at the investigated locality. However, they highlighted the negative impact of the anthropogenic factor by introducing inadequate genetic material into waters where the presence of “pure” populations is possible.

Ivić et al. (2021) established the presence of three CR mtDNA lineages of brown trout – DA, AT and MA in the area of Žumberak-Samoborsko gorje Nature Park in Croatia. By using *cytb* as a molecular marker, they analyzed the distribution, taxonomic status, level of intrapopulation diversity, and effective population sizes of trout populations within the Nature Park. The authors also emphasized the negative impact of non-native AT and MA lineages on the native populations of the DA lineage (*Salmo labrax*) and the need for conservation of its genetic character. In this research, but also in various researches on trout in the rivers of the Black Sea basin of Croatia, the nominal taxa *Salmo labrax* is often used (Piria et al., 2020; Buj et al., 2020; Ivić et al., 2021) Although it is considered part of the brown trout complex, some authors use *Salmo labrax* to describe the native Danubian lineage in Black Sea basin, while *Salmo trutta* is used to describe the Atlantic lineage of brown trout. Similarly, the nominal taxon *Salmo macedonicus* is often used to describe the AD phylogenetic lineage originating from the Aegean basin (Marić et al., 2022).

The presence of brown trout of Da1 and Da21 (Da-s6) haplotypes, but also AT haplotype, were recorded on the Southern slopes of the Mountain Stara Planina in Serbia (Kanjuh et al., 2021).

2.1.3. Introduction of non-native lineages and conservation status of native lineages of *Salmo cf. trutta*

Brown trout is an attractive fish, especially for sport and recreational fishing. It is also one of the most cultivated and therefore very commercially valued fish species. The conditions for brown trout breeding are certainly not the same for every phylogenetic lineage. Thus, in Croatia, but also in other countries of the Western Balkans, the native Danubian lineage of brown trout was initially bred, which did not prove to be adequate for intensive breeding (Piria et al., 2020). Therefore, due to the reduction of production costs and risks, the breeders adopted the breeding technology from Western Europe, and that meant the breeding of another – Western European Atlantic lineage of brown trout (Taler, 1949; Pofuk et al., 2017).

Stocking is an activity that is properly carried out for the purpose of managing fishing resources, primarily to satisfy the demands of anglers in rivers that are attractive for fishing (Jadan, et al., 2014; Piria et al., 2020). However, stocking with brown trout is also present in rivers unattractive for fishing that are characterized by the presence of populations that have an ancestral character (Tošić et al., 2016; Škraba et al., 2017). Translocations of organisms and changes in natural habitats by humans are the most common causes of hybridization and introgression of non-native genotypes into autochthonous populations (Allendorf et al. 2001). Therefore, stocking should be done exclusively with brown trout that are autochthonous to the given region with the appropriate genotype characteristic of that locality. Uncontrolled stocking and the lack of data on the fishing material used for stocking purposes are a major problem for wild sensitive and, unfortunately, increasingly rare populations of brown trout. The results of various studies of brown trout populations in the Western Balkans, along with an assessment of the negative impact of non-native lineages, indicate a long-term and constant introduction of inadequate fishing material in this area (Marić et al., 2006; Simonović et al., 2013; 2015; Škraba Jurlina et al., 2020; Ivić et al., 2021). Literature data indicate that the introduction of brown trout of allochthonous haplogroups has been going on since the middle of the 19th century, when Slovenia, Croatia and Bosnia and Herzegovina were under the rule of the Austro-Hungarian Empire (Razpet et al., 2007; Simonović et al., 2017). In the Black Sea basin, the At1 haplotype of Atlantic lineage was detected as the most frequently introduced non-native haplotype of brown trout, which breeders consider and present as autochthonous (Kalembur, 2011). However, the presence of non-native DA haplotypes, such

as Da2, cannot be ignored either. The natural range of brown trout of the Da2 haplotypes is restricted to watercourses that join the southern German and Austrian upper part of the Danube (Bernatchez, 2001; Weiss et al., 2001). Data indicate that at the end of the 19th century, brown trout of the At1 and Da2 haplotypes were transferred to the rivers of Croatia, Slovenia and Bosnia and Herzegovina, while the rivers of Montenegro were stocked in the middle of the 20th century. The rivers of Serbia were stocked at the end of the 20th and the beginning of the 21st century (Gridelli, 1936; Razpet et al., 2007; Simonović et al., 2017).

Considering that breeders in Croatia produce only Atlantic lineage of brown trout, stocking of rivers was done with the individuals that were available. In this way, allochthonous genetic material reached open waters (Jadan et al., 2007; Piria et al., 2020). The status of this lineage is not regulated by any legal act in Croatia, although this lineage outside the territory of Croatia is recognized as the main cause of the loss of the native genetic diversity of the brown trout (Weiss et al., 2001; Simonović et al., 2015; Simonović et al., 2017). Random stocking with farmed trout of non-native origin can lead to competitive exclusion of the native population or to hybridization that can lead to the loss or “pollution” of a unique genetic combinations (Taggart and Ferguson, 1986). The introduced AT lineage shows the characteristics of invasiveness (Simonović et al., 2013; 2015). This is supported by recent research that showed the rapid adaptation of this lineage to the conditions of natural watercourses, then the consumption of a wide range of available food and competition for food and space, as well as diet overlap with native DA lineage individuals (Piria et al., 2020). However, a serious problem is hybridization between different lineages of brown trout, which has been established in stocked rivers. Monitoring the genetic variability of brown trout has been extensively applied to assess the introgression of farmed lineages into wild populations (Hansen and Loeschcke, 1994; Arias et al., 1995; Largiader and Scholl, 1996; Garcia-Marin et al., 1999). In order to ensure a survival of population or species, it is necessary to preserve its genetic diversity, and therefore its evolutionary potential (Ryman et al., 1995). Unfortunately, genotyping of brown trout individuals has been carried out in a small number of fish farms in the Western Balkans. The availability of diagnostic genetic markers that make it possible to distinguish between allochthonous and autochthonous populations of brown trout ensured the monitoring of the genetic impact of releasing fish into rivers characterized by the presence of autochthonous populations. Among the genetic markers for these purposes, the L-lactate dehydrogenase (LDH-C1*) locus proved to be the most useful (more details in chapter 2.2.1.2.). The autochthonous populations of the Western Balkans are fixed for the

LDH-C*100 allele and are considered ancestral, and many analyses of other molecular markers indicate that the Balkan Peninsula is most likely the center of origin of the modern brown trout (Marić et al., 2006, Simonović, 2010). In contrast, the LDH-C*90 allele is fixed in Central European stock of fish farm origin (Garcia-Marin et al., 1991; Martinez et al., 1993; Arias et al., 1995). Continuous stocking of non-native brown trout lineages threatens the genetic integrity and survival of natural populations in this region. The native lineage is still present and dominates compared to the introduced ones (Ivić et al., 2021), but genetic research shows an increasing degree of hybridization, and thus the introgression of the non-native lineage into the autochthonous gene pool (Piria et al., 2020, Škraba Jurlina et al., 2020). Therefore, the genetic variability between and within populations and the current rate of introgression should be investigated, in order to develop further strategies for the breeding and conservation of brown trout.

2.2. Genetic and morphological methods in the study of fish populations

Although taxonomy and phylogeny increasingly rely on the molecular methods by which scientists try to resolve the complex relationships between various genera and species, morphological studies continue to be an indispensable approach and source of data for establishing similarities and differences between many fish groups.

Given that the development of each population is based on genetic features, as well as on various environmental influences, morphometric methods are certainly good indicators of the interaction between genome and habitat. The combination of both genetic and morphological analysis undoubtedly provides a complete and more representative picture of the differentiation, structure and diversity of populations, as well as their taxonomy, phylogeny and evolution.

Genetic research involves the use of genetic markers. A genetic marker is a nucleotides' or amino-acids' sequence on a DNA molecule (mitochondrial or nuclear) or protein, respectively that can be easily detected and whose inheritance can be traced (Ford-Lloyd, 1996). Various genetic markers are used to research many different fish populations. In studies on the genetics of Salmonids, especially the *Salmo trutta* species complex, the most used genetic markers are the mitochondrial control region and the gene for *cytb*, and the

nuclear gene loci LDH-C*, GH1 and GH2, the gene for transferrin, internal transcribed spacers (ITS1 and ITS2) and microsatellites (Bernatchez, 2001; Cortey et al., 2004).

Morphological methods used in ichthyological research include two groups - morphometric and meristic. Usually, when describing species greater importance is given to meristic indicators, which are less variable. Morphological characters show variability to a much greater degree than meristic characters, and this largely depends on the influence of environmental factors. Meristic measures have a much higher heritability and are therefore significantly more reliable in defining differences between individual species and varieties (Treer, 1993). Meristic characters include: the number of scales in the lateral line, the number of rays, the number of spinal vertebrae, the number of gill rakers (branchiospines), etc. Morphometric characters include the dimensions of different parts of the body and their relationships. It is a study of shape variation and its covariation with other variables (Bookstein, 1996; Dryden and Mardia, 1998). The most commonly used characteristics in the analysis of body shape and size are the distances between anatomical points on the longitudinal axis (length characteristics), the dorsoventral axis (height characteristics) and the axis connecting the left and right sides of the body (width characteristics) (Marić, 2006). This type of analysis is also known as 'traditional' or 'classical' morphometrics. In the last 20 years, unlike classical morphometrics, geometric morphometrics is increasingly used in research.

The brown trout is an excellent example of an extremely genetically and morphologically variable species, and the application of both methods in order to define a complex evolutionary history and phylogeography. The phylogenetic relationships of the subfamily Salmoninae were primarily based on morphological analyses, and different scientists interpreted the results differently. There is no doubt that the genus *Salmo* stands out from the rest based on four morphological features – the species of this genus have a wide diamond-shaped dermethmoid, the presence of a central process on the premaxillary bone, a strongly pronounced hooked growth on the lower jaw of the male and a narrow suboperculum. The species *Salmo trutta* differs from the others in having less than 10 branchiostegals (Chereshnev and Skopets, 1990). However, genetic research has contributed to a more precise definition of the relationships between salmonid species, starting with Ferguson and Fleming (1983) until today. At the end of the twentieth century, research on genetics of the family Salmonidae are increasingly numerous, mostly due to the use of this group in aquaculture (Elliott, 1994).

2.2.1. Genetic markers of the research

2.2.1.1. Control region of mitochondrial DNA

Mitochondrial DNA is a circular double-stranded molecule found in semiautonomous cell organelles – mitochondria. Linear mtDNA structures exist, but they are rare and present only in some unicellular eukaryotes (Savić Pavićević and Matić, 2011). In the animal world, mitochondria are the only organelles that possess their own genome and the ability to replicate independently of the eukaryotic cell in which they are located. The basic role of mitochondria is related to the process of oxidative phosphorylation (OXPHOS) (Ladoukakis and Zouros, 2017), which provides as much as 95% of the energy necessary for cell function (Consuegra et al., 2015). However, this organelle is also responsible for various other processes such as apoptosis, aging, signaling, metabolic homeostasis and biosynthesis of important macromolecules such as lipids and heme (Sinha et al., 2013; Bratic and Larsson, 2013; Cheng and Ristow, 2013; Chandel, 2015; Ahn and Metallo, 2015; Ladoukakis and Zouros, 2017).

With small deviations, it can be said that mtDNA is a relatively conserved molecule among animals (Moritz et al., 1987; Gissi et al., 2008) with a uniform structure. The genomic organization of mtDNA in fish is very similar to other vertebrates (Lee et al., 2001; Kim et al., 2004), including humans (Wallace, 1992; Lian and Koh, 2005). The size of mtDNA varies between 15 and 20 kbp. The length of the complete brown trout mtDNA is 16 677 bp (Lubieniecki, 2014), and it is deposited in GenBank under the code NC_024032.1). It is composed of 37 genes – two genes encoding rRNA, 22 genes encoding tRNA and 13 intronless genes encoding polypeptides involved in electron transport and oxidative phosphorylation (Boore, 1999). A non-coding region is about 1000 bp long, called the D-loop or control region (CR) – responsible for the regulation of replication and transcription of mtDNA chains (Hurst et al., 1999; Zhaoxia et al., 2010; Wang et al., 2011) (Figure 3).

mtDNA is inherited maternally (Lee et al., 1995). Data on biparental inheritance in natural populations exist and have been recorded in several species such as anchovy (Magoulas and Zouros, 1993), fruit fly (Nunes et al., 2013), mice (Gyllensten et al., 1991), oniscid crustaceans (Doublet et al. al., 2008), frogs (Radojčić et al., 2015) and humans (Schwartz and Vissing, 2002; Payne et al., 2013), but they are extremely rare and almost

negligible compared to the uniparental inheritance of this molecule. Similar to trait inheritance, mtDNA recombination process is extremely rare (Ladoukakis and Zouros, 2001; Kraysberg et al., 2004; Ma and O'Farrell, 2015), so mtDNA, barring mutations, is passed unchanged from mother to offspring. Mitochondrial DNA is characterized by a high degree of mutation. A high mtDNA mutation rate can create intraspecific polymorphism and interspecific divergence in a relatively short period of time (Avise et al., 1987). The most variable part of the mtDNA genome is the control region (Moritz et al., 1987), while the rRNA coding regions are characterized by the lowest frequency of mutations.



Figure 3. A map of the *Salmo salar* mitochondrial genome (Fridjonsson et al., 2011).

The above-mentioned properties (simple structure, maternal inheritance, absence of recombination and high level of mutations) make mtDNA an extremely suitable and widely used genetic marker. Its application is reflected in the assessment of intra- and interspecies diversity, the evaluation of the genetic structure of species or populations, the evolutionary relationships of close species or populations, as well as the determination of the genealogical relationships of the examined taxa and the assessment of the time of divergence from a common ancestor (Avise et al., 1987; Apostolidis et al., 1997). Mitochondrial DNA has been widely used in taxonomic, phylogenetic and evolutionary studies of Salmonids. The region of

the control region as well as the regions where the protein-coding genes are located has proven to be particularly useful in the analysis of recently separated populations. The most frequently used mtDNA genes in the analysis of genetic differentiation at the level of fish species and families, including Salmonids, as well as in phylogenetic research, are *cytb* and cytochrome oxidase 1 (Co-1) (Johns and Avise, 1998; Kartavtsev and Lee, 2006). Numerous studies on Salmonids, especially the *Salmo cf. trutta* species complex, are based on the analysis of the non-coding, highly variable CR of mtDNA. Despite the large number of scientific research, and therefore the numerous results obtained in resolving the relationship between the different lines of the complex of this species, interest does not decrease, and new research further deepen the question of its taxonomy, phylogeny, phylogeography and evolution. However, it has already been defined that for more precise obtaining of this type of data, CR mtDNA cannot be used as an independent genetic marker. For the *Salmo cf. trutta* species complex, information on hybridization and introgression into populations is very important, especially for conservation purposes, which cannot be obtained by analyzing only CR mtDNA, but by a combination of several genetic markers.

2.2.1.2. LDH-C1* locus

L-lactate dehydrogenase is a nuclear DNA gene and in most vertebrates is encoded by three gene loci: LDH-A*, LDH-B* and LDH-C*. Its role is in the catalysis of the mutual transformation of lactate and pyruvate, and the expression of the resulting isozymes occurs in different vertebrate tissues (McMeel et al., 2001; Oleinik et al., 2017). In genetic studies of brown trout, it was discovered that the expression of this gene is shown only by the LDH-C1* locus in eyes' retinal tissue (Oleinik et al., 2017). The LDH-C1* locus is about 440 bp long. It is highly polymorphic in brown trout and represents a very good genetic marker for the study of population genetics and phylogeography, especially the postglacial colonization of populations of this extremely variable species. In brown trout, the most frequent alleles of LDH-C1* are LDH-C*90 and LDH-C*100. Research have shown that Atlantic brown trout populations are fixed for the LDH-C*90 allele and inhabit the northwestern part of Europe (parts of the Baltic, Great Britain and Ireland, but also parts of Iceland and western Spain). These regions are considered the place of their origin (Hamilton et al., 1989). The second allele, LDH-C*100, is rarer than LDH-C*90, and is characteristic of isolated, relict populations of brown trout, mostly present in those waters where there are insurmountable barriers (Ferguson, 1989; Hamilton et al., 1989; Marshall et al., 1992). They are present in the

basins of the Black and Caspian seas, the waters of Greece, Corsica, France (parts towards the Mediterranean), and even the northern parts of Spain (Osinov, 1984; Elliott, 1994). Moreover from the research of Ferguson and Fleming (1983), LDH-C* 100 is considered an ancestral allele, in contrast to LDH-C*90, which is much more frequent.

Given that most hatchery stocks in Europe are fixed for, or show a very high frequency of, the LDH-C*90 allele, McMeel et al. (2001) emphasize the importance of using LDH-C* as a convenient marker for following the success of stocked fish and subsequent introgression. Particularly when hatchery fish are stocked into the drainages where the allele does not occur naturally or where native populations have a high frequency of the LDH-C*100 allele. For the purposes of this research, the LDH-C1* locus was used as a genetic marker to confirm hybridizations between two brown trout lineages, and to assess the degree of introgression of non-native lineages into native populations.

2.2.1.3. Microsatellite loci

Microsatellites are short segments of nuclear DNA, usually between one and six bp in length, which are repeated multiple times in succession at a particular genomic location, also known as short tandem repeats (STRs). The number of segment repeats ranges from five to over 100 per locus (Stallings et al, 1991). Microsatellites have been found in the genomes of all prokaryotes and eukaryotes studied so far (Gur-Arie et al., 2000; Zane et al., 2002), and were first discovered in eukaryotic cells in the early 1970s (Hamada et al., 1982; Fan and Chu, 2007). They are present mainly in non-coding regions, but there are also in coding regions, rarely in telomeric and centromeric parts of chromosomes (Zane et al., 2002). Based on the length of the basic repetitive motif, they can be classified into mono-, di-, tri-, tetra-, penta- and hexanucleotides (Fan and Chu, 2007), while according to the type of repeated motifs they are divided into perfect (pure), imperfect (interrupted) and complex (Weber, 1990; Jarne and Lagoda, 1996). Perfect (pure) microsatellites do not have breaks in the repeated motifs, imperfect (interrupted) have inserted nucleotides between the repeated motifs and complex microsatellites represent various combinations of two repeated motifs.

Microsatellites are characterized by a high mutation rate, estimated at 10^{-2} to 10^{-6} per locus per generation, which is 1000 to 10^7 times higher mutation frequency than in the coding parts of DNA. The result is a high level of polymorphism that is very suitable for genetic studies (WenHsiung, 1997; Schlotterer, 2000). The high rate of genetic variability and the fact

that the number of repeated motifs in microsatellites often varies between individuals of the same species, but within a range of variation characteristic of a given locus made them very useful genetic markers (Balloux and Lugon-Moulin, 2002; Savić Pavićević and Matić, 2011). The application of microsatellites in ichthyological research is wide. They are used to assess the state of native fish stocks, especially in areas where introduction is present, to control the effects of introduced lines on native species, and to assess the degree of hybridization. These types of studies are mostly related to commercially important fish species such as, for example, representatives of salmonids (Winkler and Weiss, 2008). This is supported by the fact that one of the first species of fish on which intra- and interpopulation analysis of variability was performed using microsatellites was rainbow trout *Oncorhynchus mykiss* (Nielsen et al., 1997). They are used to determine the genetic diversity of populations, the impact of stocking on native stocks (Hansen et al., 2000a, 2000b; 2002), the relation of sampled individuals (Hansen et al., 1997), the extent of local adaptations (Meier et al., 2011; Fraser et al., 2011), effective population size (Serbezov et al., 2012), as well as the formation of parent flocks for stocking (Hansen et al., 2000b). Their application is very important for researching the evolutionary history of populations and species (Kalinowski, 2002).

2.2.2. Geometric morphometrics

In this research, geometric morphometrics was used as an additional method in assessing the differences between lineages of brown trout. Adams et al. (2004) suggested that this advanced method provides more reliable statistical analysis in the specimen's morphology and serves as a technique in interpreting data.

Geometric morphometrics (GM) is the statistical analysis of shape variation and its covariation with other variables (Bookstein, 1991). This method provides quantification and visualization of differences in the shape of any morphological structure, be it two-dimensional or three-dimensional (Adams et al., 2013). GM relies on the detection of homologous landmarks (x, y coordinates of points collected on the fish profile or structures), that is, statistically comparable shape variables. Therefore, it is possible to reconstruct the shape of the group consensus and the hypothetical shape of the common ancestor (Rohlf and Marcus 1993; Rohlf et al. 1996; Cavalcanti et al. 1999; Zelditch et al. 2004). By applying GM even small changes in the shape of morphological units can be detected, which otherwise cannot be determined by traditional morphometrics. In some groups, it is possible to identify hybrid

individuals using GM as reliably as using DNA sequences (Treer and Piria, 2019). Webster and Sheets (2010) distinguish two general techniques of GM: landmark-based and outline-based. Landmark-based GM is currently the most used thanks to the short sample preparation time required and the smaller number of landmarks (and/or semi-landmarks) needed for qualitative analyses, unlike the outline-based GM which requires more time for sample preparation (Chaiphongpachara, 2018). The landmark-based GM captures the shape of organisms and can indicate subtle morphological differences between specimens or even populations of interest (Zelditch et al., 2004; Valentin et al., 2008; Fruciano et al., 2014; 2020). GM methods enable the analysis of the size and shape of the morphological entity by combining uni- and multivariate statistical methods and methods of direct graphical representation of shape variability. Instead of applying multivariate statistical methods that process the measured data of morphological entities (length, width, height, etc.), the mathematical form of morphological entities is examined through their geometry. Geometric definitions of shapes are made up of a set of features, such as proportions, angles, relative structural arrangement, and the starting basis is the arrangement or configuration of specific points in two or three planes of space (Rohlf, 2000; Adams et al., 2004). The measure of the size of the measured morphological unit in GM is represented by the size of the geometric center – centroid size, which is defined as a measure of the dispersion of specific points from the center of the measured shape. It is calculated as the square root of the sum of the squared distances of specific points from the center of the configuration (Bookstein, 1991). One of the key advantages of GM is that differences in shape can visually present directly as computer illustrations. Many different types of visualizations and shape changes are used in GM, but the most used is Thin Plate Spline (TPS). In order to compare shape between digitized configurations of landmarks, or figures, the variation attributable to the arbitrary position, orientation, and size of the figures must be estimated and removed from the data (Bookstein, 1991; Marcus et al., 1996). The most used procedure for removing the effects of size, position and orientation is the General Procrustes analysis (GPA) (Rohlf and Slice, 1990; Rohlf, 1999; Klingenberg, 2013).

Research has shown that a combination of morphological characteristics with genetic markers can be of great importance in the management of fish stocks (Roques et al., 2002; Cadrin et al., 2005; Valentin et al., 2014). Application of GM proved to be very useful in discrimination of alien and native lineages previously differentiated by molecular analyses (Monet et al., 2006; Fruciano et al., 2014). GM is also used to test significant correlations

between body shape and ecological traits or to assess the importance of phylogenetic inertia on shape similarity (Clabaut et al., 2007).

2.3. Research area

Croatia is located in Southeastern Europe on the Balkan Peninsula. It is geographically considered a part of the Western Balkans area together with Bosnia and Herzegovina, Serbia, Montenegro, Macedonia, Slovenia and Albania (De Munter, 2016).

According to the climate and relief, Croatia consists of three parts – Pannonian, Dinaric and Adriatic. The sampling locations in this research are located on selected rivers in the Pannonian and Dinaric regions of Croatia, and all belong to the Black Sea basin. The Pannonian region of Croatia consists of two areas – Northern Croatia and Slavonia, lowlands with low mountains and larger rivers Sava, Drava, Danube, Kupa and Mura. The Dinaric region of Croatia consists of the Dinaric Mountains, which separate the Black Sea and Adriatic Sea basins. This region includes the mountainous parts of Gorski Kotar, the karst fields of Lika and Krbava, and the mountains of Dalmatia: Dinara (1 831 m), Kamešnica (1 809 m), Biokovo (1 762 m) and Svilaja (1 508 m).

2.3.1. Gorski Kotar

Gorski Kotar encompasses the area of 1 270 km², of which 63% are forests. The surface of Gorski Kotar is fluvial-karst. It rises sharply and high above the Kvarner Bay of the Adriatic Sea, and its bottom is at a height of 700-800 m. Karst relief is represented by surface and underground forms. The largest surface karst forms are karst fields. The highest peak of this region is Bjelolasica (1 534 m). The most prominent fields are: Ličko, Ravnogorsko, Mrkopaljsko, Lokvarsko, Crnoluško, Gerovsko, Ogulinsko, Jaseničko and Drežničko. Gorski Kotar has several protected areas, including Zeleni vir and Risnjak National Park. In the north, below Risnjak, is placed the Kupa River spring area.

The Čabranka River is a left tributary of the Kupa River. It is only 15 km long and springs up from the crevices of the steep rocks of Veliko Obrho (546 m). Along its entire course, it is a border river between Slovenia and Croatia. Čabranka is a clean and clear mountain river. It is very attractive due to the presence of numerous rapids and waterfalls. It was declared protected in 1961. Sport fishing for trout is especially tempting.

The Curak River is located in the protected area Zeleni vir (Figure 4). It springs up west of the town of Skrad, and flows into the Kupica River, which is the right tributary of the Kupa River. It is 5.5 km long. Together with Kupa and Kupica, Curak is an extremely beautiful and popular salmonid river. Since 1921, there has been a small hydroelectric power plant of the same name “Zeleni vir” on it.



Figure 4. The Curak River and small hydroelectric power plant “Zeleni vir”.

The springhead of the Kupica River is located in Mala Lešnica. This small river is only 3 km long and flows into the Kupa River. It represents one of the first rivers where the “catch and release” principle has been fully implemented.

The Lička Jesenica River is a sinking karst river. It is located in the area of Lika, next to the area of Gorski Kotar. The river has two sources, Veliko and Malo vrelo. The length of the river from Veliko vrelo to the place of immersion is about 6.5 km. River Jesenica sinks near the town of Lička Jesenica and rises again about 15 km away, at the springhead of Slunjčica that flows into the Korana River. Lička Jesenica is very clean and shallow along the entire course. Fishing is allowed on most of the river's course.

2.3.2. The Žumberak-Samoborsko gorje Nature Park

The Žumberak-Samoborsko gorje Nature Park is a range of hills and mountains in the Pannonian region of Croatia. It consists of two parts: Žumberak hills and mountains in the central and western part, and Samobor hills and mountains in the northeastern part. The

Žumberak-Samobor Mountains are located between the rivers Krka, Sava and Kupa. It covers an area of 430 km². The highest peak of the range is Sveta Gera (1 178 m) located in the Žumberak mountain, on the border between Croatia and Slovenia (Lukić, 2008). In the entire area of the Nature Park, the unevenness of the relief is very large, and numerous deep erosion valleys with steep sides, mountain peaks and ridges contribute to this. Among the numerous stream valleys, the deeply cut valleys of the main watercourses stand out in particular: Kupčina and Slapnica in the Žumberak region, then Bregana, Lipovačka Gradna and Rudarska Gradna in the Somobor region. The area of the Nature Park is characterized by a well-developed hydrographic network with 848 registered springs and over 260 permanent or occasional watercourses. Streams of the Žumberak mountains flow into the Kupa River (Kupčina, Slapnica), and streams of the Samobor mountains flow into the Sava River (Bregana, Lipovačka Gradna and Rudarska Gradna) (Piria et al., 2020).

The Slapnica River is located in the Slapnica Valley, which is under special protection as a landscape of special importance, in the central part of the Žumberak hills. It springs at the foot of the main ridge of the Žumberak hills and flows into the Kupčina River. It has numerous tributaries located mainly on the eastern side of the valley. The name of the river originates from the existence of numerous waterfalls (“slap” in the Croatian language means “waterfall”) that arise due to the tufa deposition process or due to natural obstacles. Among the waterfalls, the largest are the Vranjački waterfall and Brisalo waterfall, both about 15 m high. These two waterfalls are not located on the Slapnica River itself, but on two of its tributaries. The Brisalo waterfall is located on the Duboka stream, which flows into Slapnica and forms a small lake that the waterfall hollowed out due to its erosive action. Brisalo waterfall is located on the Vranjak tributary. Slapnica is attractive for fishing and sports fishing is allowed (Grad Samobor, 2020) (Figure 5).

The Kupčina River is the largest river in the Žumberak region. It is formed by the joining of several smaller streams that collect forest water on the southern slopes of the Sopot Mountain, Žumberačka gora, between Sopot and Stari grad. It flows into the Kupa River. It is 56 km long, and its basin covers an area of 614 km². It has the largest springs whose capacity is between 102 and 1500 l/s. It is also special for having the largest waterfall in Žumberak and one of the largest in Croatia – the Sopot waterfall. The waterfall is located on one of the initial branches of the Kupčina River, near the town of Sošice. It is 40 m high and has three cascades. Like the Slapnica River, the Kupčina River is very attractive for sport fishing (Grad

Samobor, 2020). In its headwaters, there is a well-known fish farm “Vrabac” with brown trout and rainbow trout stocks.



Figure 5. The Slapnica River

2.3.3. Papuk Nature Park

Papuk Nature Park is a protected area of the largest part of the Mountain Papuk. It is located in the Pannonian region of eastern Croatia – Slavonia. It covers an area of 336 km², and the highest peak is Papuk (953 m). About 90% of the mountain is covered by forests of different types (Pandža, 2010). The hydrological network of the Papuk Nature Park is highly developed thanks to the geological features of this region (Kuhta and Brkić, 2003; Petrović, 1969). It is characterized by the presence of several types of rocks: igneous rocks (basalt, andesite, granite), metamorphic rocks (schist, quartzite, sandstone), and sedimentary limestone (Labak et al., 2011). Within the Nature Park, there are numerous areas that have a higher degree of protection than other parts of the park, such as the Jankovac Forest Park.

The Jankovac River is a small, clear river situated on sedimentary carbonate rocks in Jankovac Forest Park (Figure 6). It springs up at about 560 m above sea level, in an isolated karst area, with the surrounding area built of metamorphic and igneous rocks. It is about 700 m long and about 3 m wide on average. It has a 32 m high Skakavac waterfall. It flows into the Kovačica River (Ostojić et al., 2012). Only the springhead part and the waterfall have been preserved in its natural form, and a large part of the flow has been changed by anthropogenic activities. It is known that Count Josip Janković, after whom the Forest Park is

named, in the 19th century, as part of the stream bed, arranged two flow-through lakes (Figure 7), both for trout breeding and for the water supply of the 30 m high Skakavac waterfall, which also represents the mouth of the stream (Špoljar et al., 2012).



Figure 6. The Jankovac River.



Figure 7. The first flow-through lake created on the Jankovac River as part of the “Bršljan-Jankovac” picnic area.

The Toplica River also springs up on the Mountain Papuk. A clear, shallow river, on which there are small low cascading waterfalls. It is 37 km long and flows into the Ilova River.

The Orljava River springs up in the foothill of the Mountain Psunj, which continues to the Mountain Papuk (Figure 8). It is 80 km long and flows into the Sava River. The waterfall

on Orłjava is a popular fishing and picnic spot. The largest tributary of Orłjava is the River Veličanka, which springs in the foothill of Papuk and is 13 km long. Besides the Veličanka, the River Brzaja (Figure 9) is another major tributary of the Orłjava. It is characterized by extremely clean and clear water. Zvečevačko Lake was built in the area of the upper reaches of Brzaja.



Figure 8. The Orłjava River



Figure 9. The Brzaja River

3. MATERIAL AND METHODS

3.1. Material sampling

The collection of brown trout material was carried out on rivers belonging to the Danube basin, in three protected mountain areas in Croatia: Gorski Kotar and Žumberak in the continental part of western Croatia, and the slopes of Mt. Papuk and Psunj in the Slavonia region in the eastern part of Croatia (Figure 10).

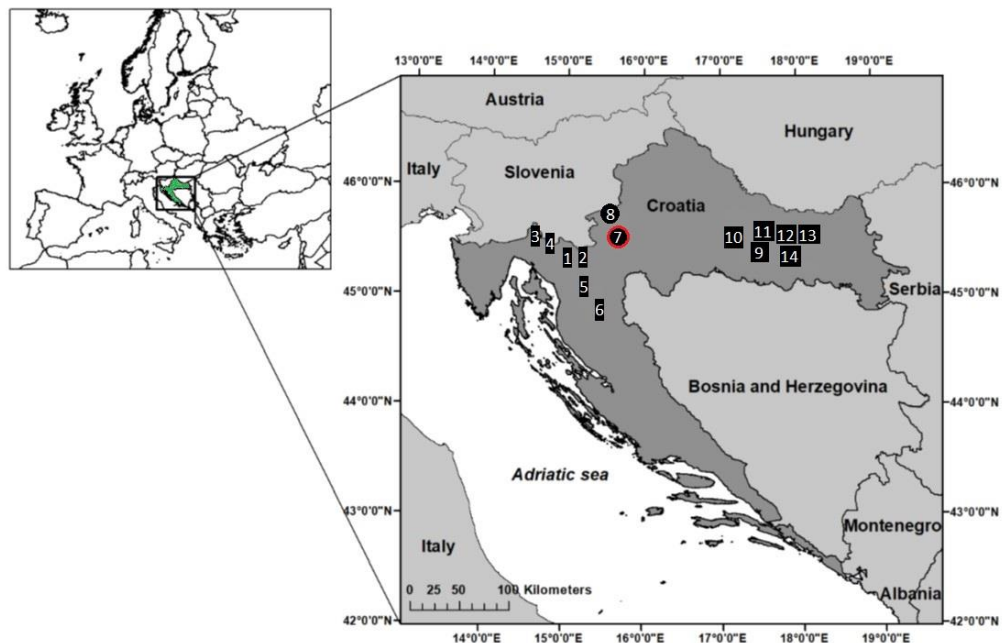

Figure 10. Map of sampling sites of brown trout in the Danube River basin of Croatia. Gorski Kotar region: 1 – Mala Lešnica, 2 – Curak, 3 – Čabranka, 4 – Bresni Potok, 5 – Jasenak, 6 – Lička Jesenica; Žumberak region: 7 – Kupčina and “Vrabac” fish farm (marked with a red circle), 8 – Slapnica; Mt. Papuk region: 9 – Orljava, 10 – Toplica, 11 – Brzaja, 12 – Jankovac-Stream, 13 – Jankovac-Lake, 14 – Veličanka

The material was sampled during two periods – April/May 2017 and May 2018. During April 2017 sampling was done in the area of Žumberak on the rivers: Kupčina, Slapnica and Lička Jesenica, and then during May 2017 in the area of Gorski Kotar on the rivers: Mala Lešnica, Curak, Čabranka, Jasenak and Bresni potok. In the area of Mt. Papuk and Psunj, the material was collected during May 2018 on the rivers: Veličanka, Orljava, Toplica, Brzaja, Jankovac-Stream and Jankovac-Lake. In addition to natural watercourses, for the purposes of research, individuals were also collected from the “Vrabac” fish farm, which

is located in the source parts of the Kupčina River. The largest part of the material was sampled by electrofishing, using two types of electro-aggregates IG200/1 (*AquaTech*, AU) and Hans Grassel 2.2.kW. Only a small number of samples, where it was not accessible to work with electric generator, were collected with a fly-fishing apparatus.

A total of 145 individuals were collected. For the purposes of genetic analysis, a part of the anal fin of each individual was taken and stored in labeled tubes of 2 ml with 96% ethanol. For the purposes of morphological analysis, 92 individuals were sacrificed, while the other 53 individuals were returned alive to the water. All collected material was frozen and stored at -20°C until processing for analyses. Due to the poor quality of the material, four individuals were excluded from the analysis, so the total number of analyzed individuals was 141 for genetic analysis and 90 for geometric morphometrics (Table 1).

Table 1. Number of individuals by sampling location and type of analysis.

Locality	Label	Genetic analyses	Morphometric analyses
Mala Lešnica	LE	12	10
Curak	CZ	12	7
Čabranka	ČA	11	-
Jasenak	JA	6	-
Bresni potok	BP	11	10
Kupčina	KČ	10	11
“Vrabac” fish farm	KČR	14	10
Slapnica	SL	10	10
Lička Jesenica	LJ	9	-
Veličanka	VE	6	4
Orljava	OR	5	4
Toplica	TO	13	10
Brzaja	BR	9	9
Jankovac-Stream	JP	5	5
Jankovac-Lake	JJ	8	-
Total		141	90

3.2. Genetic analyses

Extraction, amplification and restriction analysis were performed at the Center for Genotyping of Fishing Resources at the Faculty of Biology, University of Belgrade. Sequencing and fragment analysis were performed in the laboratories of MACROGEN® Europe. Analysis of the length of fragments of microsatellite loci for some samples was

additionally performed at the Center for Human Molecular Genetics, Faculty of Biology, University of Belgrade. The obtained results were analyzed in different software packages.

3.2.1. DNA extraction

The DNA extraction procedure included two phases. The first phase involved sample preparation, and the second phase involved isolation of DNA molecules using the Quick-gDNA™ MiniPrep extraction kit (*Zymo research Corporation, USA*). During the first phase, samples of the anal fin of each individual, about 4 mm² in size, were washed with distilled water and dried on paper. They were then transferred to tubes with a volume of 1.5 ml and the following reagents were added: 200 µl of extraction TEN buffer, 7 µl of sodium dodecyl sulfate (SDS) (*AccuGene® SDS, Lonza, CH*) and 5 µl of proteinase K (*Applied Biosystems®, USA*). After vortexing, the samples were incubated for 1 hour at 65°C and 500 rpm. The second phase in the DNA extraction procedure was performed using “columns” according to the manufacturer's instructions Quick-gDNA™ MiniPrep (*Zymo research Corporation, USA*) for proteinase K digested material (*Applied Biosystems®, USA*). The final product was DNA dissolved in 70 µl of buffer (DNA Elution Buffer). The success of DNA extraction was checked on a 1% agarose gel (Procedure described in chapter 3.2.3).

3.2.2. Amplification

Amplification of the desired fragments of the DNA molecule, was performed using the Polymerase Chain Reaction (PCR) method. For genetic analysis in this research, the PCR method was used to amplify the part of CR mtDNA, LDH-C1* locus and microsatellite loci. All PCR reactions were performed in the ProFlex™ PCR System (*Applied Biosystems®, USA*), according to a pre-defined program for each PCR reaction.

Part of CR mtDNA was amplified using the primers Trutta-mt-F (5'-TGAATGAACCTGCCCTAGTAGC-3') (Brkušanin, 2018; unpublished) and HN20 (5'-GTGTTATGCTTTAGTTAAGC-3') (Bernatchez and Danzmann, 1993) in the PCR reaction mixture of the composition shown in the Table 2. The PCR reaction conditions were as follows: initial denaturation (95°C, 5 min), 35 cycles of denaturation (94°C, 1 min), primer binding (52°C, 1 min), elongation (72°C, 2 min) and final elongation (72°C, 10 min).

The nuclear LDH-C1* locus was amplified with the primers Ldhxon3F (5'-GGCAGCCTTCTCCTCAAAAACGCCCAA-3') and Ldhxon4R (5'-CAACCTGCTCTCCTCCTCCTGGACGAA-3') (McMeel et al., 2001) in a PCR reaction mixture of the composition shown in the Table 3. The PCR reaction conditions were as follows: initial denaturation (95°C, 5 min), 30 cycles of denaturation (94°C, 1 min), primer binding (62°C, 1 min), elongation (72°C, 1 min) and final elongation (72°C, 10 min). The obtained products were further analyzed by Restriction Fragment Length Polymorphism (RFLP) method. This method involves the use of restriction enzymes that recognize a certain sequence on the DNA molecule and cut it at that point, creating fragments of different lengths. The restriction enzyme BseII (*Thermo Fisher Scientific*, USA) was used in this research. The reaction mixture was made according to the manufacturer's instructions (*Thermo Fisher Scientific*, USA): 10 µl of LDH-C* PCR reaction product, 1.5 µl of BseII enzyme, 2 µl of 10X Tango buffer and 18 µl of dH₂O. After mixing with a vortex, the samples were incubated for 16 hours at 55°C, on the pre-set program in the ProFlex™ PCR System (*Applied Biosystems*®, USA). The results of this analysis were determined by visualization on a 2% agarose gel. BseII cuts the DNA at CCCNNNNN/NNGGG. In the case of the LDH-C*90 allele, this enzyme recognizes the specified sequence creating two fragments, one 360 bp long and the other 80 bp long. In the case of the LDH-C*100 allele, in which there is a substitution of G in A, the restriction enzyme BseII does not recognize the indicated sequence and the fragment remains 440 bp long. In heterozygotes LDH-C*90/100, three bands are observed on the gel, of which the first two (440 and 360 bp) are very clear. In homozygotes (LDH-C*100/100 or LDH-C*90/90) only one band can be observed – 440 bp long for LDH-C*100/100, which travels slower on the gel, or 360 bp for LDH-C*90/90 which travels faster on the gel. The 80 bp fragment is usually not visible on the gel.

Eight microsatellite loci were amplified in four duplex reactions, combining two of the non-overlapping PCR product lengths (Appendix A). The total volume of the mixture for all four duplex reactions was 10 µl, and its composition was as follows: forward and reverse primers for a specific locus (final concentration of primers shown in the Table 4 for all four duplex reactions), dH₂O, 1X PCR buffer (*Invitrogen*™, USA), 0.2 mM dNTP, 1.5 mM MgCl₂, 0.5 U Taq polymerase (*Invitrogen*™, USA) and 2 µl DNA sample. Amplification conditions for the first three duplex reactions were: initial denaturation (94°C, 3 min), 30 cycles of denaturation (94°C, 45 s), primer binding (60°C, 1 min), elongation (72°C, 30 s) and final elongation (72°C, 1h). In the fourth duplex reaction, primer binding was set at 57°C, and

the number of cycles was 35, while the other conditions were identical to those for the other duplex reactions.

Table 2. Composition of the PCR reaction mixture for CR mtDNA.

Final concentration	Reagent
	dH ₂ O
1X	10X PCR buffer (<i>Invitrogen</i> TM , USA)
0.2 mM	10 mM dNTP
1.5 mM	25 mM MgCl ₂
1.5 μM	10 μM Trutta-mt-F (forward primer)
1.5 μM	10 μM HN20 (reverse primer)
1.5 U	5 U/μl <i>Taq</i> DNA-polymerase (<i>Invitrogen</i> TM , USA)
2 μl	~100ng DNA
Σ = 30 μl	

Table 3. Composition of the PCR reaction mixture for the LDH-C* locus.

Final concentration	Reagent
	dH ₂ O
1X	10X PCR buffer (<i>Invitrogen</i> TM , USA)
0.2 mM	10 mM dNTP
1.5 mM	25 mM MgCl ₂
0.5 μM	10 μM Ldhxon3F (forward primer)
0.5 μM	10 μM Ldhxon4R (reverse primer)
1.5 U	5 U/μl <i>Taq</i> DNA-polymerase (<i>Invitrogen</i> TM , USA)
3 μl	~100ng DNA
Σ = 30 μl	

3.2.3. Electrophoresis on agarose gel

The success of DNA isolation and the obtained PCR products of nuclear LDH-C*, as well as the results of RFLP analysis, were performed using the method of electrophoresis on agarose gel. Depending on the expected length of the PCR product (fragments), an agarose gel of different density is made, which means that the gel is less dense for longer fragments. Agarose gel consists of agar and 0.5x TBE buffer. A 1% gel (1 g agar dissolved in 0.5x TBE buffer added to 100 ml) was used to check DNA extraction, while a 2% gel was used to check LDH-C* fragments (2 g agar dissolved in 0.5x TBE buffer added to 100 ml is added up to 100 ml). The agar-buffer mixture is heated to boiling point. After that, it is cooled, with

occasional stirring with a glass rod, in order to polymerize evenly. Immediately before pouring the gel into the molds for electrophoresis, 2-3 μ l of fluorescent dye SybrGreen is added (*Lonza*, CH) which enables visualization of the product. The gel poured into the mold remains until complete cooling and polymerization. The gel is transferred from the mold to an electrophoresis bath filled with 0.5x TBE buffer covering the gel. Before pouring the samples into the gel wells, the samples are mixed with 1 μ l of gel loading dye blue 6x (*Thermo Fisher Scientific*, USA) on parafilm. After applying the samples to the gel, a suitable standard (marker) for DNA size is poured into the last well. A 1 kbp marker (*Thermo Fisher Scientific*, USA) was used to check DNA extraction, while a 50 bp marker (*Thermo Fisher Scientific*, USA) was used for LDH-C*. Electrophoresis was performed for 30 minutes at a voltage of 100 V. DNA in the gel was visualized using a UV-transilluminator (*Vilber Lourmat*, FR) under light with a wavelength of 302 nm.

Table 4. Final concentration of primers used in duplex reactions.

Microsatellite loci		Final concentration
1° duplex reaction		
Str73INRA	10mM forward primer	0.15 μ M
	10mM reverse primer	0.15 μ M
Ssa410Uos	10mM forward primer	0.4 μ M
	10mM reverse primer	0.4 μ M
2° duplex reaction		
SsaD190	10mM forward primer	0.2 μ M
	10mM reverse primer	0.2 μ M
SsaD71	10mM forward primer	0.2 μ M
	10mM reverse primer	0.2 μ M
3° duplex reaction		
Ssa85	10mM forward primer	0.1 μ M
	10mM reverse primer	0.1 μ M
SSsp2216	10mM forward primer	0.2 μ M
	10mM reverse primer	0.2 μ M
4° duplex reaction		
OMM1064	10mM forward primer	0.2 μ M
	10mM reverse primer	0.2 μ M
SsoSL438	10mM forward primer	0.4 μ M
	10mM reverse primer	0.4 μ M

3.2.4. Genetic data analysis program

CR mtDNA sequences were analyzed in ClustalX2 (Larkin et al., 2007), MEGA X (Kumar et al., 2018) and Arlequin 3.5.2.2 (Excoffier and Lischer, 2010) programs.

The obtained sequences were analyzed with the ClustalX2 program, both with each other and with those haplotypes that would be expected to be present in the investigated localities, whose sequences were downloaded from GenBank (<http://www.ncbi.nlm.nih.gov/genbank>) within the National Center for Biotechnology Information (NCBI). Mutual relationships of haplotypes were determined in the program MEGA X, using Maximum Likelihood and Neighbor-Joining methods, both based on the Kimura 2-parameter model and bootstrap consensus tree inferred from 1000 replicates, while the pairwise distances were calculated using the Maximum Composite Likelihood model. For analyses in the Arlequin program, the populations were divided into four groups, according to the river basin to which they belong. Molecular variance (AMOVA), the genetic diversity between the pairs of populations (pairwise F_{ST}), the F_{ST} fixation index (using a pairwise difference method) and the composition and diversity of nucleotides were analyzed in this way.

The following software were used for the analysis of microsatellite loci: Fstat 2.9.3.2 (Goudet, 2002), GENETIX 4.05 (Belkhir et al., 1996-2004), POPULATIONS 1.2.31 (Langella, 2002), STATISTICA 6.0 (StatSoft, Inc., 2001), Arlequin 3.5.2.2 (Excoffier and Lischer, 2010), STRUCTURE 2.3.4 (Pritchard et al., 2000), STRUCTURE Harvester (Earl and vonHoldt, 2012), BOTTLENECK 1.2.02 (Cornuet and Luikart, 1996; Piry et al., 1999).

In the software Fstat, the values of the F-statistics for the assessment of Hardy-Weinberg equilibrium (HWE) were calculated and p-values for F_{IS} within samples were based on 120 000 randomizations. In the GENETIX software, the expected, objective and observed heterozygosity values, then the average number of alleles per locus, allele frequency, fixation indices, Nei's distances between populations per 1000 permutations and corresponding factorial analysis (FCA) were obtained. POPULATION was used to calculate shared allele distances (DAS) and construct a Neighbor-Joining (NJ) tree. The results of Nei's distances were used for CLUSTER analysis using the method Unweighted pair-group average (UPGMA) and dissimilarities from matrix in the software STATISTICA. FCA and DAS results are graphically presented in this program. Arlequin software was used to calculate population average pairwise differences between populations and within each population

(F_{ST}). Software STRUCTURE was used to analyze the structure of populations. The assumed number of groups was $K = 15$, the testing period was set from 100,000 to 200,000, which was repeated seven (7) times for each group K . To estimate the most likely value of K according to Evanno et al. (2005), STRUCTURE Harvester software was used. BOTTLENECK was used to evaluate the manifestation of the bottleneck effect. The results were obtained based on three tests - Sign test, Standardized differences test and Wilcoxon test (Sign-rank test) and three mutation models – infinite-allele model (IAM), two-phase mutation model (TPM) and stepwise mutation model (SMM). Parameters for evaluating significance for all three tests were: proportion of one mutational step in TPM at 95%, mutation variance for TPM set at 12 and 100 000 iterations. The results of the Standardized differences test were not used for the analysis, because at least 20 microsatellite loci are necessary, as well as the IAM because it is not reliable for microsatellite analysis (Cornuet and Luikart, 1996). The results of these two tests give the equilibrium expected (H_{eq}) and observed heterozygosity (H_e) values. If the results show that H_e is greater than H_{eq} at most loci, it is considered that a bottleneck effect has occurred in the population.

3.3. Morphometric analyses

The preparation, processing and analysis of data for geometric morphometry were done at the Faculty of Agriculture, University of Zagreb. The total length (TL) of all individuals was measured using ichthyometer and the sex was determined by the gonadal observation method. Individuals were photographed with a Sony Cybershot DSC-HX300 digital camera according to a procedure suitable for geometric morphometry described in Fruciano (2016).

3.3.1. Geometric morphometrics methods

3.3.1.1. Preparation of samples and data

TPSDig2 2.30 software (Rohlf, 2017a) was used to digitize photographed individuals, combining point markings from Monet et al. (2006) and Fruciano et al. (2020). A total of 19 points were used, of which 9 landmarks and 10 semi-landmarks. For the digitization of the trout eye, 6 additional points were used, which were removed before statistical analyses (Figure 11). Digitized photographs were then processed in TPSrelw software (Rohlf, 2017b)

using Generalized Procrustes Analyses (GPA) with sliding landmarks, in order to obtain Procrustes coordinates that define the centroid size and shape variables.

R packages in GeometricMorphometricsMix software (R Core team, 2019) and Morpho software (Schlager, 2017) were used for vector modeling and orthogonal data projection methods, in order to remove shape variations caused by arching of fish body and sexual dimorphism. First, the arching effect was removed for 12 randomly chosen and intentionally bent individuals. To remove the shape change due to sexual dimorphism, between-group Principal Component Analysis (PCA) was applied first on Procrustes coordinates with the removed arching effect in two groups (males and females), and then data were projected orthogonally onto this newly generated principal component (Fruciano, 2016). In order to eliminate allometric shape variations, MorphoJ 2.0 software (Klingenberg, 2011) was used, applying the regression method of shape variables onto centroid size, and only residuals of this regression were used as shape data in further analyses.

Before analyzing the data, the individuals were divided into three groups based on genetic analysis: Atlantic lineage (AT), Danubian lineage (DA) and their hybrids (Hy).

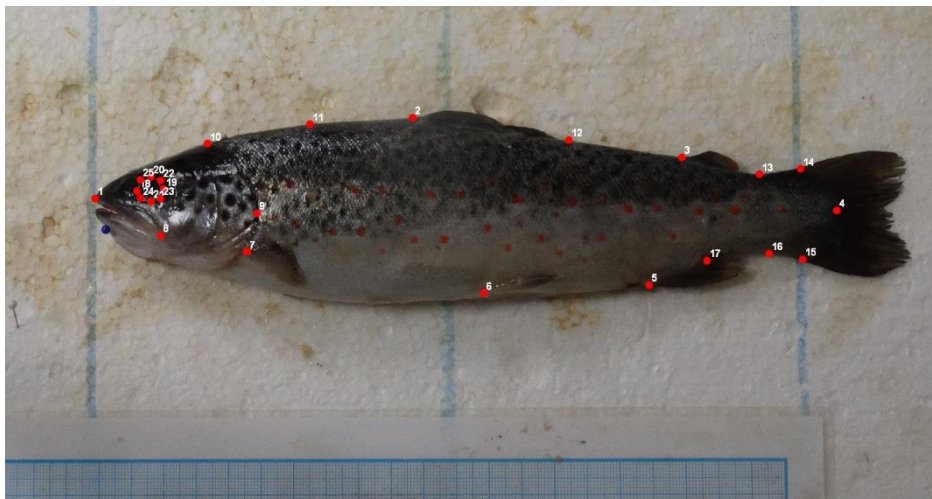

Figure 11. Sample preparation for digitization using point-marking. Points 1-9 represent fixed landmarks, points 10-19 represent semilandmarks and 20-25 are helper points (Špelić et al., 2021).

3.3.1.2. Processing of morphometric data

MorphoJ 2.0 software (Klingenberg, 2011) was used to estimate digitization error, as well as for Canonical Variate Analysis (CVA) and Discriminant Function Analysis (DFA). Digitization errors were evaluated based on the repeatability (R) value using the Procrustes ANOVA method. A random selection of 20 individuals was digitized a second time, in order to compare the original and new values of Procrustes coordinates for centroid size and shape variables. The assessment of the reference value for R was done according to Koo and Li (2016): poor for values less than 0.50, moderate between 0.50 and 0.75, good between 0.75 and 0.90, and excellent when greater than 0.90. The Procrustes ANOVA method also assessed the shape differences among lineages for all 90 individuals.

Canonical Variate Analysis (CVA) was used to determine possible shape differences between lineages of brown trout. Discriminant Function Analysis (DFA) was used to confirm the classification based on shape differences, using cross-validation test for group pairs (AT-DA, AT-Hy and DA-Hy). In order to test the null hypothesis of equal group means, the values of Permutation tests of Procrustes distances and T-square statistic were calculated.

Geomorph 4.0.4 (Adams et al., 2013; 2014) was used to calculate the Procrustes variance for overall disparity, as well as for each group and pairs of groups, using morphol.disparity set to 1000 permutations. Additionally, PCA was also used to assess shape variation within each group per sampling site.

4. RESULTS

4.1. Sequence analysis of the CR mtDNA

In the investigated rivers of the Danube basin in Croatia, two phylogenetic lineages of brown trout are present – DA and AT. Within the DA lineage, three haplotypes were detected: Da1, Da2 and Da22. Within the AT lineage, only the At-H3 (At1) haplotype was detected (Table 5). The most numerous was the Da1 haplotype (73 individuals), followed by At1 haplotype (31 individuals), then Da2 (24 individuals), and the least numerous was the Da22 haplotype (13 individuals) (Figure 12).

Table 5. CR mtDNA haplotypes of brown trout in researched rivers of Croatia. n – number of individuals, DA – Danubian lineage, AT – Atlantic lineage.

River	Drainage	n	DA			AT
			Da1	Da2	Da22	At-H3 (At1)
Mala Lešnica	Kupa	12	9			3
Curak	Kupa	12	10			2
Čabranka	Kupa	11	9	2		
Jasenak	Kupa	6	4			2
Bresni potok	Kupa	11		2		9
Slapnica	Kupa	19	8	2		
Kupčina	Kupa	14	13			1
“Vrabac” fish farm	Kupa	10				10
Lička Jesenica	Lička Jesenica	9	1	8		
Veličanka	Sava	6	3		1	2
Orljava	Sava	5			5	
Brzaja	Sava	9		1	7	1
Toplica	Drava	13	10	2		1
Jankovac-Stream	Drava	5	5			
Jankovac-Lake	Drava	8	1	7		
Total		141	73	24	13	31

The remaining eight individuals differed and were described as two new haplotypes (subtypes). The newly described haplotypes were detected in three individuals from the Jankovac-Stream due to a C → T transition at polymorphic position 853, and five individuals from the Toplica River due to a T → C transition at polymorphic position 662. These haplotypes are deposited in GenBank under the names Da1f (Accession Numbers MK675073) and Da1g (Accession Number MK675074), respectively (Table 6). Their

position in relation to other DA haplotypes is shown in Figure 13 and Figure 14. The results of this method also showed the clustering and close relationship of two different haplotypes, Da1b and Da2c, which is supported by the results of the pairwise distance values (Table 7).

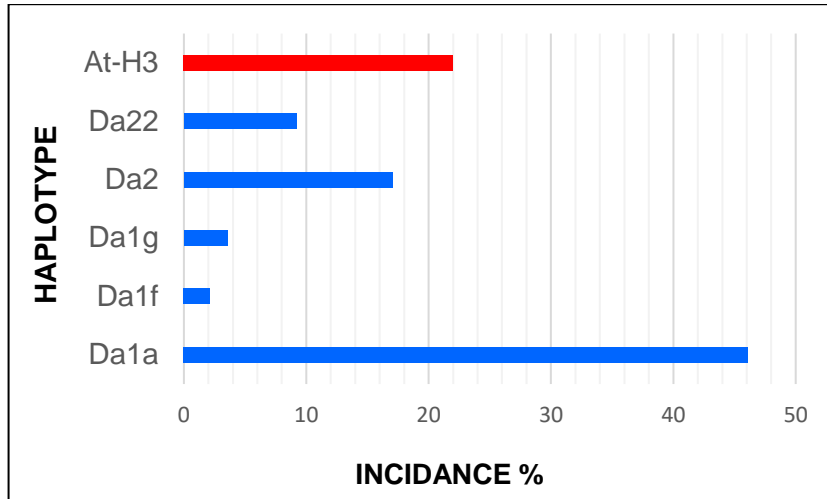

Figure 12. Incidence of haplotypes in investigated rivers of the Danube basin in Croatia.

The highest percentage of variability based on the results of the analysis of molecular variance (AMOVA), for populations grouped according to a certain river drainage, was detected within the analyzed populations (83.36%), with the corresponding value of the fixation index $F_{ST} = 0.16644$ (Table 8). The population pairwise (F_{ST}) results showed the highest value for the populations' pair Lička Jesenica and Kupa. All F_{ST} values were statistically significant ($p < 0.05$) (Table 9).

Table 6. Polymorphic sites of CR mtDNA sequences of brown trout haplotypes. Novel haplotypes are marked with asterisk (*). Dots (.) indicate the same nucleotide as in first sequence and slash (/) gaps in sequence.

Haplotype	Variable positions of CR mtDNA																							
	2	26	145	177	233	234	235	388	389	529	541	542	544	547	662	838	853	877	893	899	905	906	924	926
Da1a	C	A	G	T	G	A	G	T	C	C	A	C	T	T	T	A	C	T	A	G	A	C	A	A
Da1b	T	.	.
Da1c	C
Da1d
Da1f*	T
Da1g*	C
Da2a	G	/	.	/	.
Da2b	.	.	.	C	.	G
Da2c	G	T	.	.
Da23a	.	.	A	.	A	G	G
Da23b	.	.	A	.	A	G	C
Da23c	.	.	A	T
Da22	T
Da21	T	G	.	.	G
At-H3	T	T	T	C	T	T	G	G	.	C	A

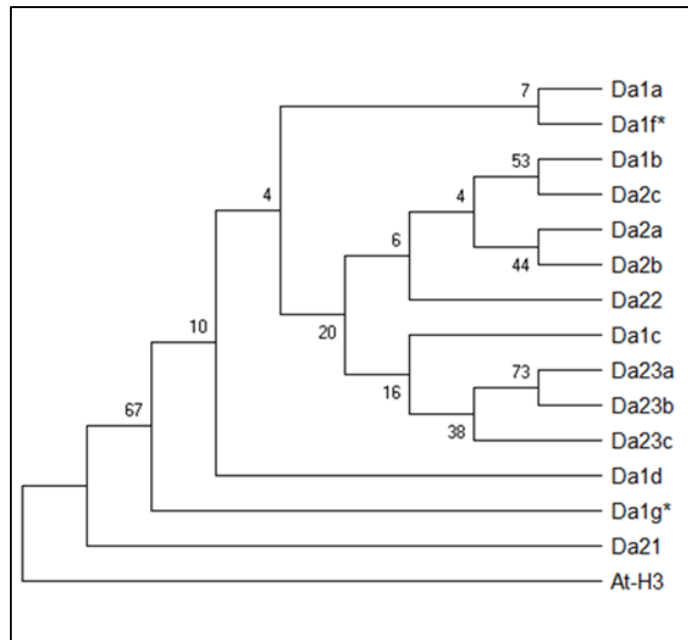

Figure 13. Maximum Likelihood rooted bootstrap tree showing the relationship between novel haplotypes (*) and selected CR mtDNA haplotypes of brown trout from the Danube basin and one from the AT phylogenetic lineage (as an outgroup). Numbers indicate bootstrap probabilities.

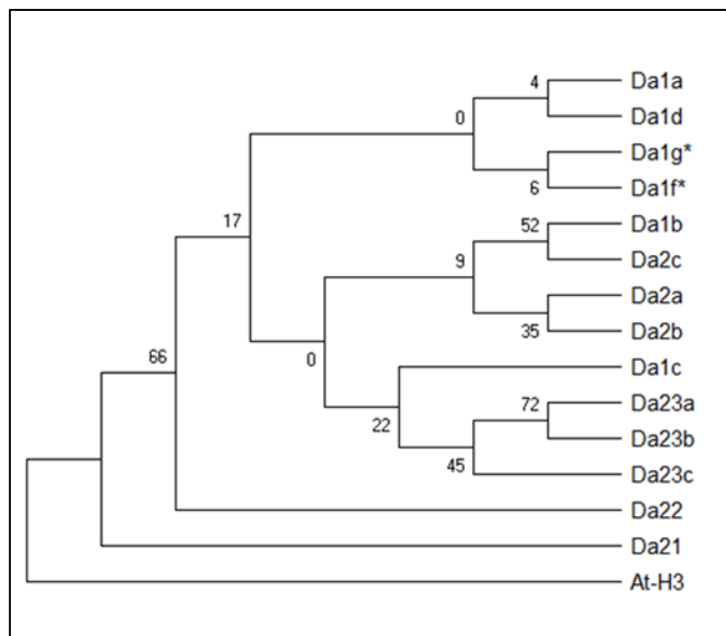

Figure 14. Neighbor-Joining rooted bootstrap tree showing the relationship between novel haplotypes (*) and selected CR mtDNA haplotypes of brown trout from the Danube basin and one from the AT phylogenetic lineage (as an outgroup). Numbers indicate bootstrap probabilities.

Table 7. Pairwise distance values between selected CR mtDNA haplotypes of brown trout. Novel haplotypes are represented with asterisk (*).

	Da1a	Da1b	Da1c	Da1d	Da1f*	Da1g*	Da2a	Da2b	Da2c	Da21	Da22	Da23a	Da23b	Da23c	At1
Da1a															
Da1b	0.001														
Da1c	0.001	0.002													
Da1d	0.001	0.002	0.002												
Da1f*	0.001	0.002	0.002	0.002											
Da1g*	0.001	0.002	0.002	0.002	0.002										
Da2a	0.001	0.002	0.002	0.002	0.002	0.002									
Da2b	0.002	0.003	0.003	0.003	0.003	0.003	0.001								
Da2c	0.002	0.001	0.003	0.003	0.003	0.003	0.001	0.002							
Da21	0.003	0.004	0.004	0.004	0.004	0.004	0.004	0.005	0.005						
Da22	0.001	0.002	0.002	0.002	0.002	0.002	0.001	0.002	0.002	0.004					
Da23a	0.004	0.005	0.005	0.005	0.005	0.005	0.003	0.004	0.004	0.007	0.004				
Da23b	0.004	0.005	0.003	0.005	0.005	0.005	0.003	0.004	0.004	0.007	0.004	0.002			
Da23c	0.004	0.005	0.005	0.005	0.005	0.005	0.005	0.006	0.006	0.007	0.005	0.006	0.006		
At1	0.011	0.012	0.012	0.012	0.012	0.012	0.012	0.013	0.013	0.012	0.012	0.015	0.015	0.015	

Table 8. Analysis of molecular variance (AMOVA) among and within populations of brown trout from different drainages. *df* – the degrees of freedom in the source, F_{ST} – fixation index, V_a – among population variance, V_b – within population variance

Variation source	df	Sum of squares	Variance components	Percentage of variation
Among population	3	37.011	0.38810 V_a	16.64
Within population	137	266.280	1.94365 V_b	83.36
Total	140	303.291	2.33175	
F_{ST}	0.16644			

Table 9. Significant differences (distances) between populations of brown trout from different drainages. KU – Kupa, LJ – Lička Jesenica, S – Sava, D – Drava, G – gene diversity, π – nucleotide diversity, F_{ST} values are given under diagonal, F_{ST} p-values are given above diagonal ($p < 0.05$ are shown in bold)

	KU	LJ	S	D	G	π
KU	-	0.018	0.036	0.009	0.523	0.0002
LJ	0.2463	-	0.000	0.009	0.222	0.0002
S	0.1077	0.2003	-	0.000	0.558	0.0035
D	0.1684	0.1475	0.1334	-	0.763	0.0019

4.2. Analysis of the nuclear LDH-C1* locus

Restriction analysis of the nuclear LDH-C1* locus revealed a high degree of hybridization between individuals of DA and AT haplogroups. Of the 141 analyzed trout, 76 were found to originate from parents belonging to different mtDNA CR haplogroups: 21 individuals were defined as DA haplogroup, and according to RFLP analysis they were homozygous for LDH-C*90, while 6 individuals were defined as AT haplogroup, and according to RFLP analysis they are homozygotes for LDH-C*100. For the other 65 individuals, it was shown that the results of RFLP analysis match the results of CR mtDNA, which means that these individuals both on the maternal and paternal lines come from the same haplogroup. Thus, RFLP analysis showed that these individuals are homozygous for the LDH-C* allele that is characteristic of the haplogroup to which they belong. The results of CR mtDNA and RFLP analysis were congruent for all individuals in the population only in the “Vrabac” fish farm, showing that all individuals in both the maternal and paternal lines originate from the AT haplogroup. More specifically, according to CR mtDNA analysis, these individuals belong to the AT haplogroup, and according to RFLP, they are homozygous for the LDH-C*90 (Figure 15) allele. In all other populations, the presence of hybrids together with individuals of “pure” haplogroups (Figure 16) was established.



Figure 15. Result of restriction analysis of samples from the Kupčina River.

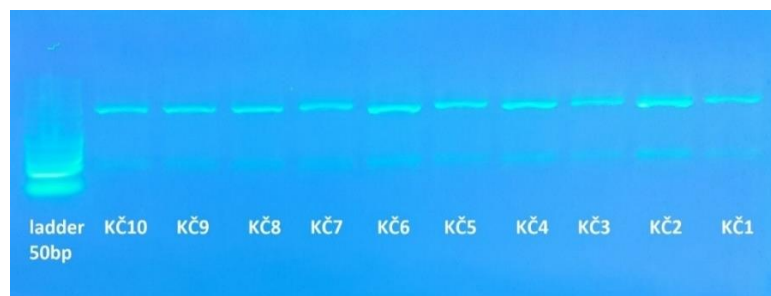

Figure 16. Result of restriction analysis of samples from the “Vrabac” fish farm.

4.3. Analysis of microsatellite loci

The results of F_{IS} analyses showed that the populations are in Hardy-Weinberg equilibrium. Table 10 shows the average p-values for each population, less than the obtained nominal value of 0.00042.

The highest expected (Hexp.) and observed (Hobs.) heterozygosity were calculated for the population from the Jasenak River (Table 11). The lowest value of expected heterozygosity was recorded in the Jankovac-Stream population and was 0.537. Slightly higher, but still lower Hexp. value compared to the others, was in the Orjava River population (0.542). This population recorded the lowest value of observed heterozygosity (0.475), as well as the lowest average number of alleles (3.875). The population of the Curak River showed an even lower value of observed heterozygosity (0.458). The highest average number of alleles was calculated for the population of the Kupčina River (8.875).

The highest number of alleles, i.e., the highest allelic richness, was recorded at the loci OMM1064 (16 alleles) and SsoSL438 (14 alleles) in the population of the Jasenak River (Appendix B). A large number of alleles (13) was also recorded in the Bresni potok population, also at the OMM1064 locus. The lowest number of alleles (1) was at the Ssa85 locus in the population of the Lička Jesenica River.

Results of pairwise differences (F_{ST}) between populations showed the highest average value between individuals from “Vrabac” fish farm and Jankovac-Stream (5.02), while the highest average pairwise difference within population was in the Curak River (3.87) (Table 12). These results are in concordance with GENETIX software analysis (Table 13), confirming that F_{ST} is the highest between “Vrabac” fish farm and Jankovac-Stream (0.27). Gene flow (Nm) was the smallest between the “Vrabac” fish farm and the Jankovac-Stream (0.69) and is generally lower if the pairwise distances between the populations are smaller, and vice versa. Nei's distances between populations showed similar results. The highest values were between individuals from the pond and individuals from the rivers Veličanka (1.458), Čabranka (1.408) and Jankovac-Stream (1.318) (Table 14). The value of the distance between individuals from the rivers Slapnica and Veličanka (1.395) is also highlighted.

Table 10. Proportion of randomizations that gave a smaller F_{IS} values than the observed at the analyzed microsatellite loci. LE – Mala Lešnica, CZ – Curak, ČA – Čabranka, JA – Jasenak, BP – Bresni potok, SL – Slapnica, KČ – Kupčina, KČR – “Vrabac” fish farm, LJ – Lička Jesenica, VE – Veličanka, OR – Orlava, TO – Toplica, JP – Jankovac-Stream, JJ – Jankovac-Lake, BR – Brzaja

Loci \ Localities	LE	CZ	ČA	JA	BP	SL	KČ	KČR	LJ	VE	OR	TO	JP	JJ	BR
Str73INRA	0.804	1	0.997	0.762	0.721	1	0.996	1	0.658	0.485	0.990	0.200	NA	0.951	1
Ssa410Uos	0.939	0.925	0.348	0.692	0.998	0.999	0.982	0.617	0.548	0.328	0.857	0.787	0.990	0.899	0.984
SsaD190	0.673	0.813	0.993	0.588	0.236	0.920	0.619	0.266	0.823	0.485	1	0.584	0.533	0.140	0.826
SsaD71	0.931	0.819	0.375	0.389	1	0.926	0.882	0.764	0.979	0.996	0.763	0.974	0.889	NA	1
Ssa85	0.959	0.968	0.943	0.589	0.134	0.997	0.890	0.522	NA	0.908	1	0.989	1	0.522	1
SSsp2216	0.984	0.983	0.918	0.726	0.133	0.940	0.933	0.445	0.998	0.990	0.306	0.881	0.571	0.996	0.965
SsoSL438	0.188	0.969	0.695	1	0.072	0.964	0.406	0.845	0.655	0.969	1	0.928	1	0.224	0.615
OMM1064	0.999	0.910	0.977	0.956	0.622	0.897	0.765	0.997	0.999	0.992	1	0.944	0.971	0.998	0.999
All	0.969	0.986	0.996	0.961	0.994	1	0.749	0.973	0.951	1	1	0.984	0.969	0.677	0.541

Table 11. Average heterozygosity of microsatellite loci in the studied populations. Hexp. – expected heterozygosity, Hn.b. – objective heterozygosity, Hobs. – observed heterozygosity, SD – standard deviation, p – probability, $\bar{A}n$ – average number of alleles per loci, LE – Mala Lešnica, CZ – Curak, ČA – Čabranka, JA – Jasenak, BP – Bresni potok, SL – Slapnica, KČ – Kupčina, KČR – “Vrabac” fish farm, LJ – Lička Jesenica, VE – Veličanka, OR – Orjava, TO – Toplica, JP – Jankovac-Stream, JJ – Jankovac-Lake, BR – Brzaja

	LE	CZ	ČA	JA	BP	SL	KČ	KČR	LJ	VE	OR	TO	JP	JJ	BR
Hexp.	0.765	0.659	0.630	0.780	0.764	0.682	0.683	0.663	0.581	0.670	0.542	0.685	0.537	0.653	0.568
SD	0.144	0.200	0.167	0.071	0.090	0.160	0.270	0.121	0.288	0.147	0.269	0.213	0.326	0.144	0.306
Hn.b.	0.798	0.687	0.660	0.850	0.800	0.718	0.708	0.698	0.615	0.731	0.603	0.713	0.597	0.697	0.601
SD	0.150	0.209	0.175	0.077	0.095	0.169	0.280	0.128	0.305	0.161	0.298	0.221	0.362	0.153	0.324
Hobs.	0.688	0.458	0.511	0.812	0.784	0.525	0.598	0.670	0.542	0.646	0.475	0.615	0.575	0.609	0.514
SD	0.124	0.244	0.266	0.226	0.175	0.287	0.264	0.225	0.281	0.188	0.301	0.240	0.377	0.245	0.302
p (0.95)	1	1	1	1	1	1	1	1	0.875	1	1	1	0.875	1	1
p (0.99)	1	1	1	1	1	1	1	1	0.875	1	1	1	0.875	1	1
$\bar{A}n$	7.625	6.500	4.750	6.250	7.250	6.375	8.875	5.750	5.250	5.250	3.875	6.750	4.375	4.750	5.875

Table 12. Population average pairwise differences (F_{ST}). The average number of pairwise differences between populations are shown below diagonal, and the average number of pairwise differences within population are shown as diagonal elements. VE – Veličanka, OR – Orłjava, LE – Mala Lešnica, TO – Toplica, LJ – Lička Jesenica, SL – Slapnica, JA – Jasenak, JP – Jankovac-Stream, JJ – Jankovac-lake, BR – Bresni potok, CZ – Curak, ČA – Čabranka, KČ – Kupčina, KČR – “Vrabac” fish farm, BP – Brzaja

Localities	VE	OR	LE	TO	LJ	SL	JA	JP	JJ	BR	CZ	ČA	KČ	KČR	BP
VE	3.20														
OR	3.16	2.67													
LE	3.53	3.54	3.49												
TO	3.71	3.79	3.73	3.72											
LJ	3.56	3.42	3.47	4.01	2.79										
SL	3.61	3.48	3.48	4.05	3.41	2.87									
JA	3.51	3.54	3.53	3.71	3.50	3.47	3.20								
JP	3.53	3.37	3.49	4.12	3.88	3.43	4.15	2.76							
JJ	3.27	3.29	3.47	3.91	3.81	3.48	3.44	3.30	3.03						
BR	3.19	2.63	3.38	3.87	3.10	3.24	3.63	3.08	3.53	2.20					
CZ	4.01	4.27	3.81	4.27	3.68	3.92	4.04	4.11	4.06	3.91	3.87				
ČA	4.03	3.84	3.76	4.22	3.90	3.68	4.05	3.67	3.77	3.61	4.07	3.38			
KČ	3.47	3.76	3.75	4.26	3.49	3.17	3.72	3.81	3.76	3.48	3.89	4.03	3.16		
KČR	4.01	4.08	4.11	4.08	4.08	3.71	3.03	5.02	3.94	4.46	4.62	4.67	3.87	2.41	
BP	3.88	3.81	3.87	3.98	4.04	3.41	3.35	4.31	3.51	4.19	4.47	4.04	3.90	3.24	3.18

Table 13. Genetic distances for populations pairs shown by fixation index values (F_{ST}) are shown under diagonal, and estimated gene flow values (Nm) are shown above diagonal. VE – Veličanka, OR – Orljava, LE – Mala Lešnica, TO – Toplica, LJ – Lička Jesenica, SL – Slapnica, JA – Jasenak, JP – Jankovac-Stream, JJ – Jankovac-Lake, BR – Bresni potok, CZ – Curak, ČA – Čabranka, KČ – Kupčina, KČR – “Vrabac” fish farm, BP – Brzaja

Localities	VE	OR	LE	TO	LJ	SL	JA	JP	JJ	BR	CZ	ČA	KČ	KČR	BP
VE		1.84	4.04	1.93	1.23	1	3.02	0.88	1.26	1.39	1.46	1.33	1.38	0.87	1.5
OR	0.12		2.14	1.02	1.42	0.95	1.66	1.39	1.49	5.26	1.64	1.42	1.85	0.84	1.15
LE	0.06	0.10		2.64	2.37	1.46	19.09	2.13	1.82	2.15	4.69	2.21	3.83	1.46	2.41
TO	0.11	0.20	0.09		1.11	1.23	3.25	0.86	1.4	1	1.48	0.97	1.29	1.35	1.73
LJ	0.17	0.15	0.10	0.18		1.06	1.77	0.86	1.04	1.8	2.94	1.05	2.14	0.84	1.15
SL	0.20	0.21	0.15	0.17	0.19		2.1	0.87	1.02	0.93	1.23	0.88	1.6	1.26	1.77
JA	0.08	0.13	0.01	0.07	0.12	0.11		1.26	1.78	1.37	2.58	1.54	2.48	2.33	5.52
JP	0.22	0.15	0.11	0.22	0.23	0.22	0.17		1.46	1.68	1.56	1.2	2.02	0.69	1.1
JJ	0.17	0.14	0.12	0.15	0.19	0.20	0.12	0.15		1.34	1.26	1.54	1.5	1.14	1.72
BR	0.15	0.05	0.1	0.20	0.12	0.21	0.15	0.13	0.16		2.02	1.47	3.07	0.76	0.95
CZ	0.15	0.13	0.05	0.14	0.08	0.17	0.09	0.14	0.17	0.11		1.49	2.84	1.17	1.32
ČA	0.16	0.15	0.1	0.21	0.19	0.22	0.14	0.17	0.14	0.15	0.14		1.36	0.74	1.28
KČ	0.15	0.12	0.06	0.16	0.10	0.13	0.09	0.11	0.14	0.08	0.08	0.15		1.46	1.41
KČR	0.22	0.23	0.15	0.16	0.23	0.17	0.10	0.27	0.18	0.25	0.18	0.25	0.15		2.3
BP	0.14	0.18	0.09	0.13	0.18	0.12	0.04	0.19	0.13	0.21	0.16	0.16	0.15	0.10	

Table 14. Nei's distances values between pairs of populations. VE – Veličanka, OR – Orłjava, LE – Mala Lešnica, TO – Toplica, LJ – Lička Jesenica, SL – Slapnica, JA – Jasenak, JP – Jankovac-Stream, JJ – Jankovac-lake, BR – Bresni potok, CZ – Curak, ČA – Čabranka, KČ – Kupčina, KČR – “Vrabac” fish farm, BP – Brzaja

Localities	VE	OR	LE	TO	LJ	SL	JA	JP	JJ	BR	CZ	ČA	KČ	KČR	BP
VE	-														
OR	0.537	-													
LE	0.446	0.513	-												
TO	0.593	0.856	0.482	-											
LJ	0.688	0.470	0.400	0.719	-										
SL	1.395	1.006	0.985	0.890	0.789	-									
JA	0.676	0.750	0.352	0.514	0.608	0.832	-								
JP	1.052	0.492	0.493	1.035	0.741	1.086	0.946	-							
JJ	0.910	0.568	0.706	0.709	0.749	1.139	0.881	0.549	-						
BR	0.583	0.212	0.419	0.781	0.345	0.897	0.766	0.383	0.547	-					
CZ	0.770	0.532	0.306	0.647	0.291	0.852	0.609	0.536	0.783	0.376	-				
ČA	0.740	0.540	0.488	0.987	0.670	1.198	0.853	0.609	0.565	0.458	0.570	-			
KČ	0.810	0.465	0.345	0.769	0.363	0.636	0.619	0.418	0.646	0.264	0.347	0.627	-		
KČR	1.458	1.022	0.863	0.714	0.968	0.822	0.629	1.318	0.858	1.078	0.816	1.408	0.642	-	
BP	1.027	0.953	0.721	0.733	0.866	0.770	0.511	0.972	0.736	1.096	0.979	0.885	0.910	0.520	-

CLUSTER analysis of Nei's distances in the STATISTICA software showed population groupings. Two groups stood out. Four populations (Slapnica, Jasenak, Bresni potok and fish farm) were grouped together, and the remaining 11 were in the other group. At the same time, the population of the Slapnica River is clearly separated both in relation to Jasenak, Bresni potok and the pond, as well as in relation to the other grouping of the remaining 11 populations (Figure 17). Within the second group (11 populations), several sister populations stood out: Veličanka and Toplica, Orljava and Brzaja, Mala Lešnica and Kupčina, as well as Lička Jesenica and Curak. There is also a clear separation of the population from Jankovac-Stream. DAS values showed small deviations from Nei's distances. The population from the Slapnica River was also isolated by this analysis (Figure 18). However, the population from the Jasenak River completely approaches the population from the Toplica River, while Veličanka, Mala Lešnica and Kupčina were separated.

Corresponding factorial analysis is shown graphically in Figure 19. Based on all three factors, the separation of the population of the Slapnica River can be observed Figure 19A. Other separations are not shown. All populations showed overlapping according to the results of the corresponding factorial analysis (Figure 19A-C), as well as according to the results of the DAS distances (Figure 20).

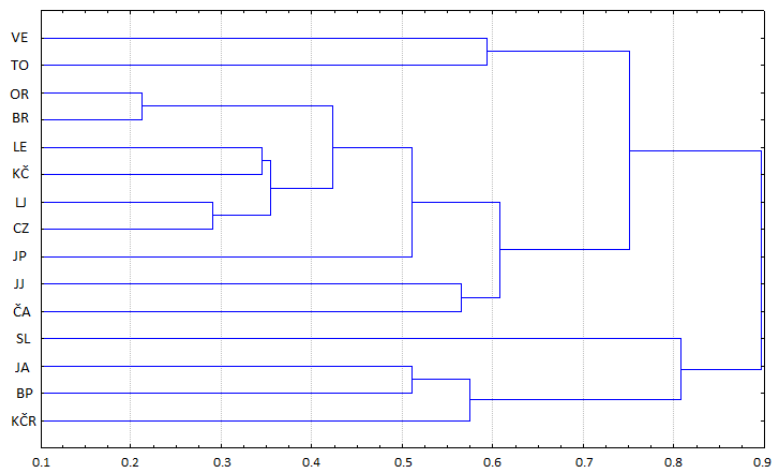

Figure 17. CLUSTER analysis of matrix distances of 15 investigated populations according to Nei's distances. VE – Veličanka, OR – Orljava, LE – Mala Lešnica, TO – Toplica, LJ – Lička Jesenica, SL – Slapnica, JA – Jasenak, JP – Jankovac-Stream, JJ – Jankovac-lake, BR – Bresni potok, CZ – Curak, ČA – Čabranka, KČ – Kupčina, KČR – “Vrabac” fish farm, BP – Brzaja

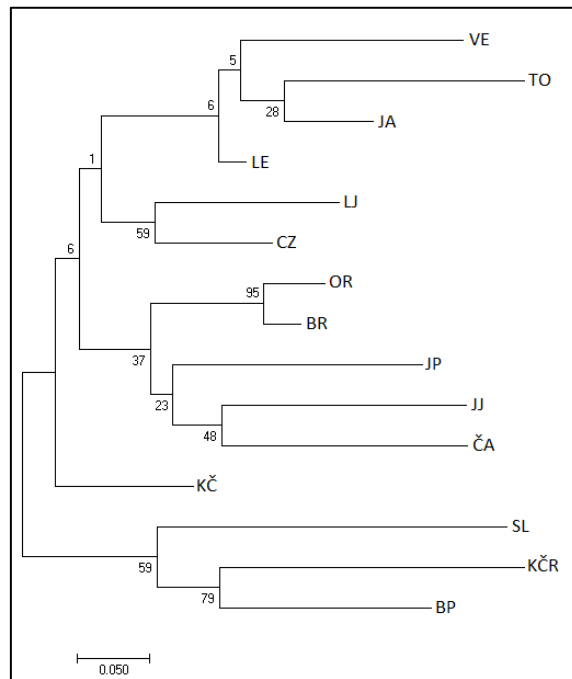
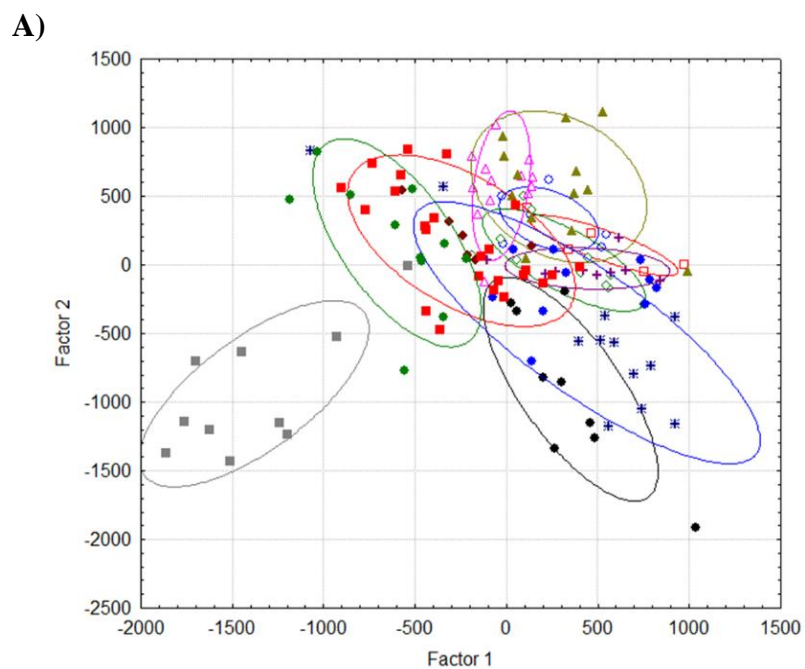

Figure 18. Clustering of populations using the Neighbor-Joining rooted bootstrap tree method according to DAS values. VE – Veličanka, OR – Orljava, LE – Mala Lešnica, TO – Toplica, LJ – Lička Jesenica, SL – Slapnica, JA – Jasenak, JP – Jankovac-Stream, JJ – Jankovac-lake, BR – Bresni potok, CZ – Curak, ČA – Čabranka, KČ – Kupčina, KČR – “Vrabac” fish farm, BP – Brzaja



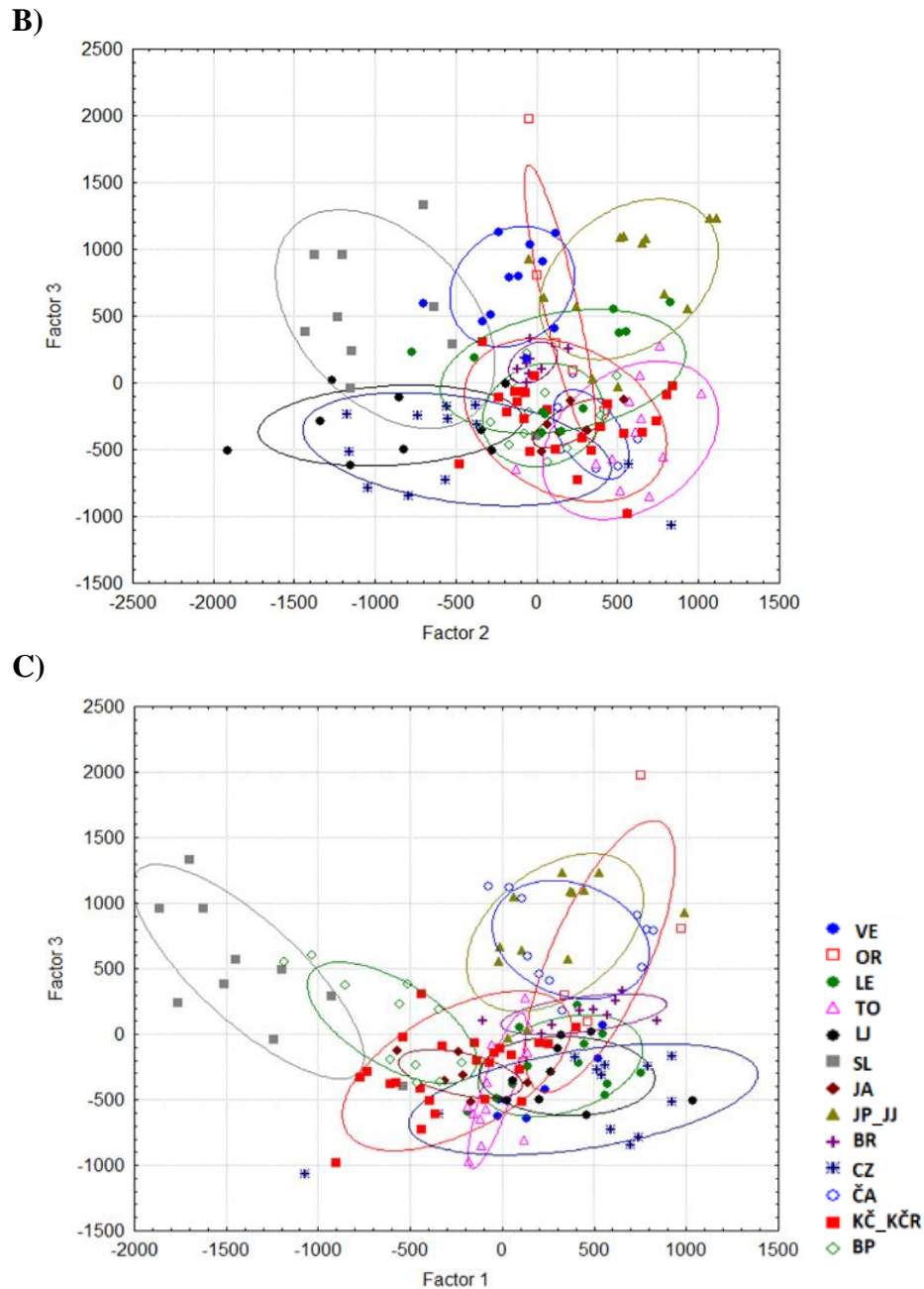

Figure 19. Corresponding factor analysis of 15 analyzed populations according to factors: **A)** 1/2, **B)** 2/3 and **C)** 1/3.

The results of structuring the sample (all 15 populations) showed that ΔK reaches its maximum value when $K = 2$ (Figure 21A), which means that the individuals are divided into two populations (Figure 21B). The structuring of populations was very much congruent with the mtDNA haplogroup to which individuals belong. One population (green) included individuals of the DA lineage, while the other (red) included individuals of the AT lineage and hybrids. This division is best shown for trout from the Curak River. Out of 12 individuals

in this population, 11 of them belonged to the DA lineage and all of them were grouped in the population with other individuals of the DA lineage (green). The remaining two individuals belonged to the AT lineage (one is homozygous for LDH-C*90, and the other is heterozygous) and were part of the population of AT individuals (red). Given that the analysis showed a large population overlap, further structuring was not done.

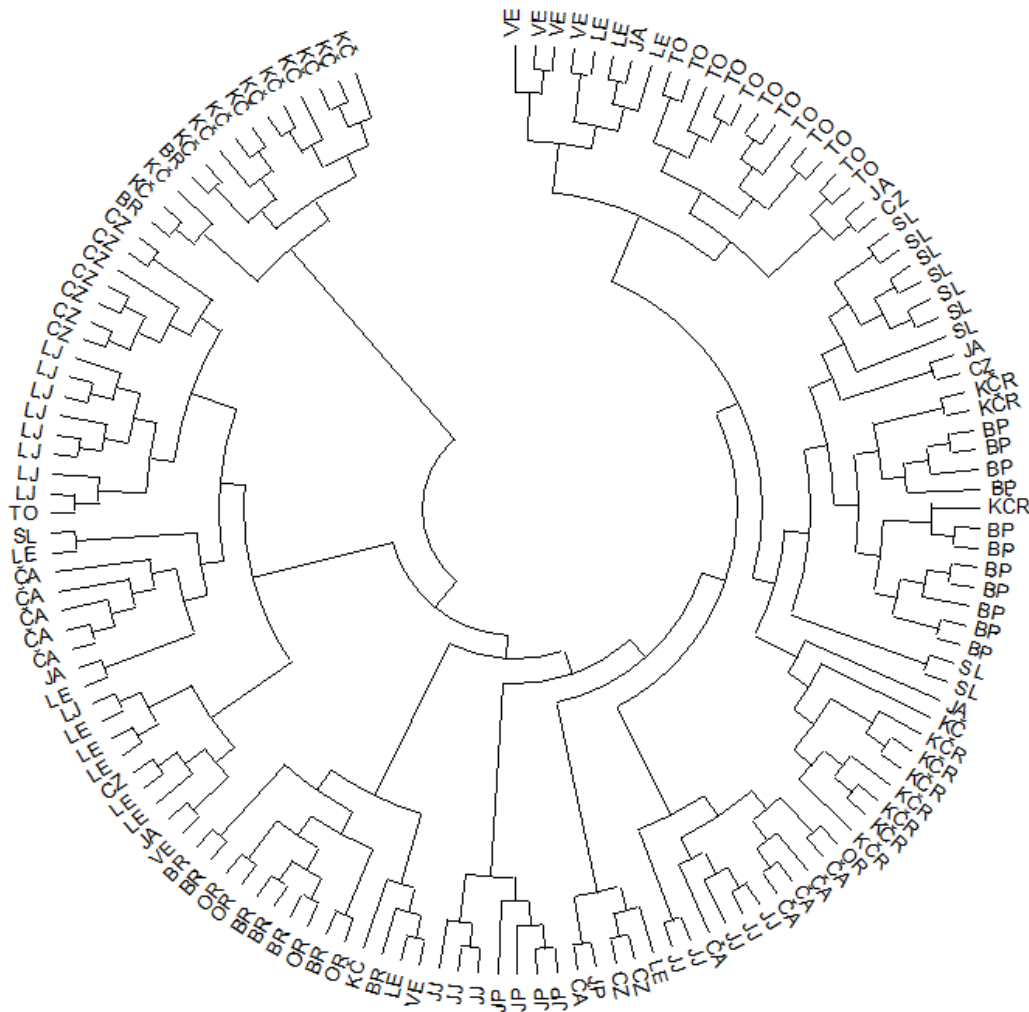
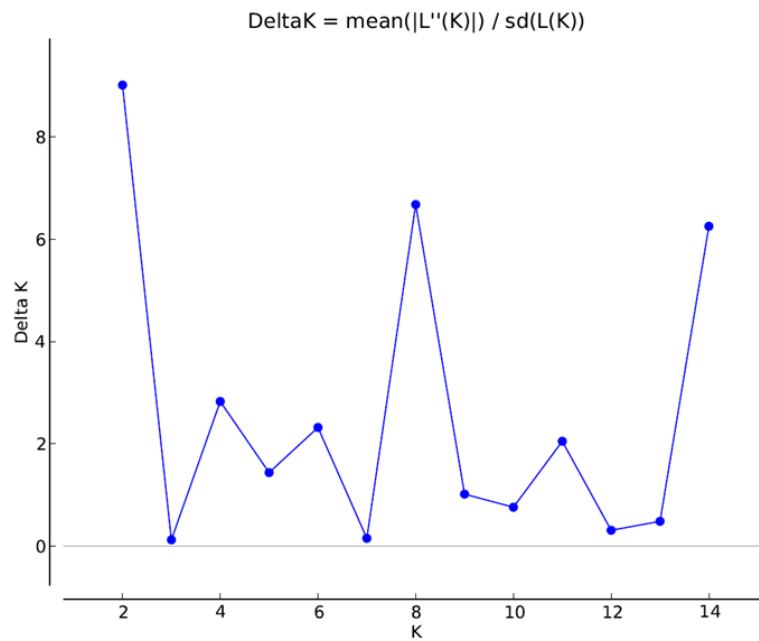

Figure 20. Grouping of individuals according to DAS values. VE – Veličanka, OR – Orljava, LE – Mala Lešnica, TO – Toplica, LJ – Lička Jesenica, SL – Slapnica, JA – Jasenak, JP – Jankovac-Stream, JJ – Jankovac-Lake, BR – Brzaja, CZ – Curak, ČA – Čabranka, KČ – Kupčina, KČR – “Vrabac” fish farm, BP – Bresni potok

A)



B)

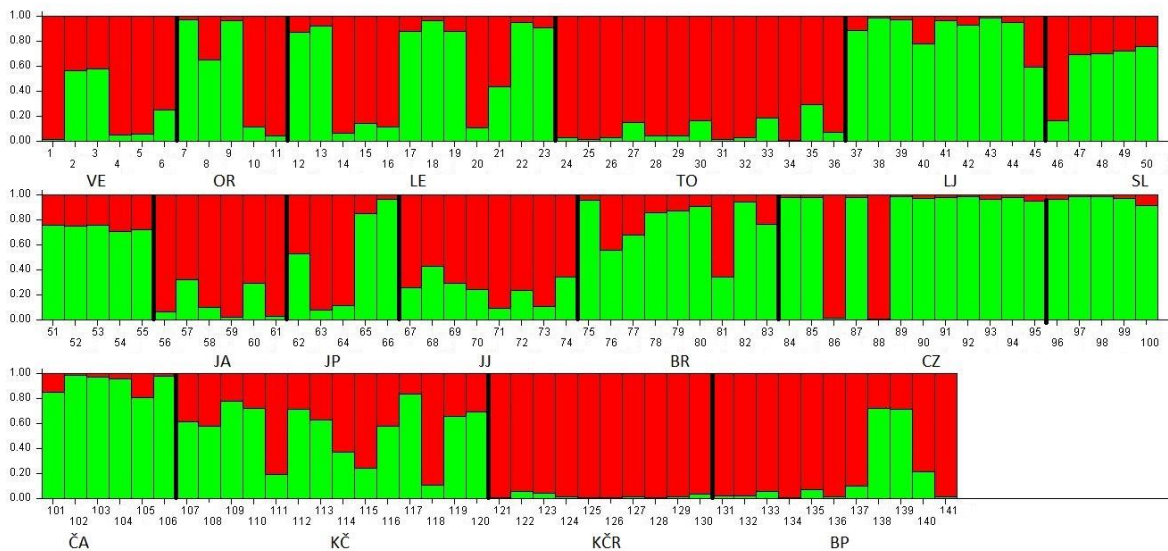

Figure 21. A) Value of ΔK and B) population structuring. VE – Veličanka, OR – Orłjava, LE – Mala Lešnica, TO – Toplica, LJ – Lička Jesenica, SL – Slapnica, JA – Jasenak, JP – Jankovac-Stream, JJ – Jankovac-Lake, BR – Brzaja, CZ – Curak, ČA – Čabranka, KČ – Kupčina, KČR – “Vrabac” fish farm, BP – Bresni potok

The evaluation of the bottleneck effect in the BOTTLENECK software was done for all 15 populations individually. However, due to the smaller number of individuals in the populations (less than 10) required by the BOTTLENECK software, the bottleneck effect

could not be assessed with certainty for the following populations: Veličanka, Orłjava, Lička Jesenica, Jasenak, Jankovac-Stream, Jankovac-Lake and Brzaja. The results showed that the H_e value was higher than the H_{eq} value in the populations from the rivers Orłjava (at five loci according to TPM), Jankovac-Stream (at five loci according to TPM and SMM) and Brzaja (at six loci according to TPM and SMM). Also, the mode-shift test did show deviations from the L-shaped distribution of allele frequencies for the populations from the rivers Orłjava and Jankovac-Stream. In the other populations, only in the population from the Čabranka River, the value of H_e was higher than the value of H_{eq} at six loci according to TPM, and at five loci according to SMM. However, no locus had the probability lower than 0.05. The mode-shift test did not show deviations from the L-shaped distribution of allele frequencies.

TPM and SMM showed a significant deficit of heterozygosity in the populations of Brzaja, Curak and “Vrabac” fish farm, and only according to the SMM model in the population of Kupčina, indicating the recent expansion of these populations (Table 15).

Table 15. Wilcoxon test results based on two mutation models – TPM and SMM. Bold values are significantly lower than 0.05. D – heterozygosity deficiency, E – heterozygosity excess, VE – Veličanka, OR – Orłjava, LE – Mala Lešnica, TO – Toplica, LJ – Lička Jesenica, SL – Slapnica, JA – Jasenak, JP – Jankovac-Stream, JJ – Jankovac-Lake, BR – Brzaja, CZ – Curak, ČA – Čabranka, KČ – Kupčina, KČR – “Vrabac” fish farm, BP – Bresni potok

	TPM		SMM	
VE	0.125D	0.902E	0.098D	0.963E
OR	0.273D	0.770E	0.273D	0.770D
LE	0.578D	0.473E	0.230D	0.808E
TO	0.156D	0.875E	0.125D	0.902E
LJ	0.289D	0.766E	0.289D	0.766E
SL	0.156D	0.875E	0.125D	0.902E
JA	0.808D	0.230E	0.808D	0.230E
JP	0.234D	0.812E	0.234D	0.812E
JJ	0.726D	0.320E	0.726D	0.320E
BR	0.014D	0.990E	0.014D	0.990E
CZ	0.020D	0.986E	0.010D	0.994E
ČA	0.680D	0.371E	0.629D	0.422E
KČ	0.125D	0.902E	0.027D	0.980E
KČR	0.010D	0.994E	0.006D	0.996E
BP	0.473D	0.578E	0.422D	0.629E

4.4. Analysis of morphological variations of brown trout lineages

Procrustes ANOVA for the assessment of digitization error showed that the mean squares of individual variation for both centroid size and shape are greater than the mean squares of error in digitization (Table 16). Repeatability values were excellent for both centroid size ($R = 0.9986$) and shape ($R = 0.8692$). Procrustes ANOVA for shape data showed that the difference in shape between lineages is statistically significant ($p < 0.05$) (Table 17).

Table 16. Procrustes ANOVA results for the assessment of digitization error of variation for both centroid size and shape in 20 randomly selected individuals. SS – sum of squares, MS – mean squares, df – degrees of freedom, F – F ratio, p – probability

Effect	SS	MS	df	F	p
Centroid size					
Individual	13336.3827	70.3359	19	1378.1500	< 0.0001
Digitization error	1.0207	0.0510	20		
Shape					
Individual	0.0438	6.7760E-5	646	14.2800	< 0.0001
Digitization error	0.0032	4.7435E-6	680		

Table 17. Procrustes ANOVA results for shape variation assessment in 90 individuals. SS – sum of squares, MS – mean squares, df – degrees of freedom, F – F ratio, p – probability

Effect	SS	MS	df	F	p
Shape					
Lineage	0.0033	4.8870E-5	68	3.0000	< 0.0001
Individual	0.0482	1.6297E-6	2958		

According to the CVA results, the CV1 axis with 83.45%, shows a clear separation of AT lineage individuals from DA and hybrids, positioning AT individuals towards the positive end, and DA and hybrids towards the negative end of the axis. The CV2 axis with a much lower percentage (16.55%) shows the separation of DA lineage individuals from hybrids, positioning DA individuals towards the positive end, and hybrids towards the negative end of the axis (Figure 22). According to the CV1 axis, the largest variations that separate AT lineage individuals from DA lineage individuals and hybrids are determined for body depth, head length and eye size. Changes in body depth are defined by landmarks 11, 2, 3, 17, 6 and

7, changes in head length are defined by landmarks 1 and 9, and changes in eye size are defined by landmarks 18 and 19 (CV1+ in Figure 22). Comparing these changes, DA lineage trout and hybrids have a more aerodynamic body appearance, a more elongated head and a larger eye (CV1- in Figure 22). According to the CV2 axis, variations in shape between individuals of the DA lineage and hybrids exist but are insignificant. Compared to individuals of DA lineage (CV2+ in Figure 22), in hybrids (CV2- in Figure 22) a slight movement of the anterior part of the body upwards and the posterior part of the body downwards is observed. There is also a difference in head length, showing that the head of the DA individual is slightly longer than the head of the hybrid.

The results of the cross-validation test from DFA showed that the AT lineage was separated in the highest percentage from the DA lineage and hybrids, while the separation of the DA lineage from the hybrid was shown with the lowest percentage (Table 18). It was also confirmed that AT lineage individuals are separated due to shape variations that are most pronounced for body depth, head length and eye size (Figure 23).

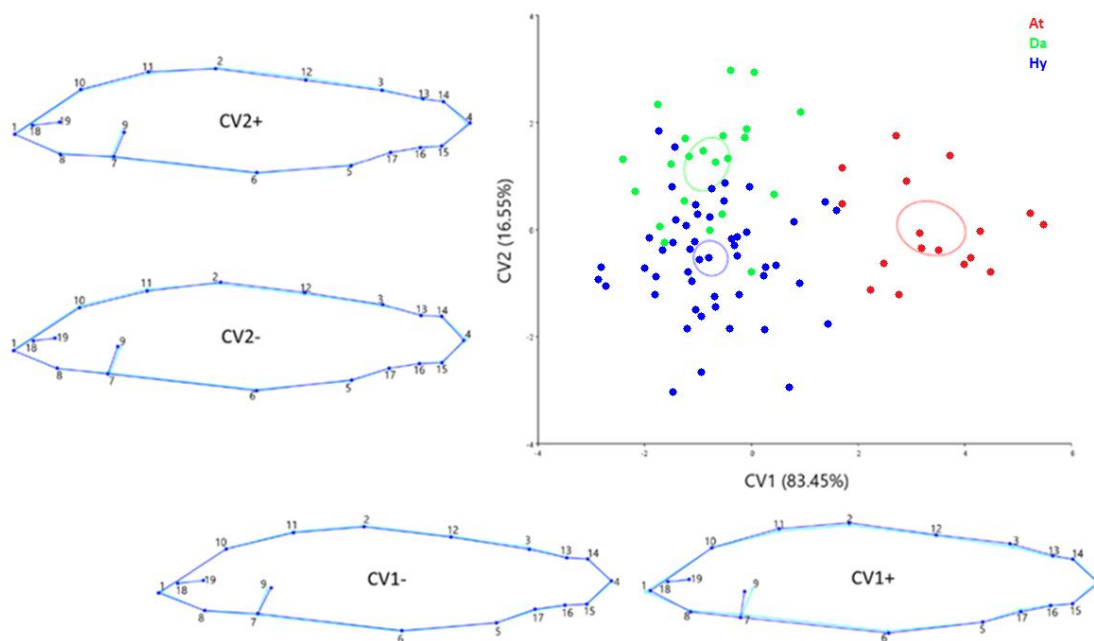

Figure 22. Scatterplot of the first two canonical variate axes of CVA depicting trout shape variation, including mean ellipses. Wireframe graphs with 19 marked landmarks represent shape change along the first and second CV axes, from negative to positive extremes. Light blue outlines represent the average shape and dark blue outlines represent extreme shape changes. At – Atlantic lineage, Da – Danubian lineage, Hy – hybrids

Table 18. Results of the cross-validation test in DFA for the compared groups of trout. Numbers in brackets represent the correctly assigned individuals in relation to the total number of compared individuals. AT – Atlantic lineage, DA – Danubian lineage, Hy – hybrids

AT/DA/Hy	AT	DA	Hy
AT	-	53% (9/17)	76% (13/17)
DA	68% (15/22)	-	45% (10/22)
Hy	84% (43/51)	53% (27/51)	-

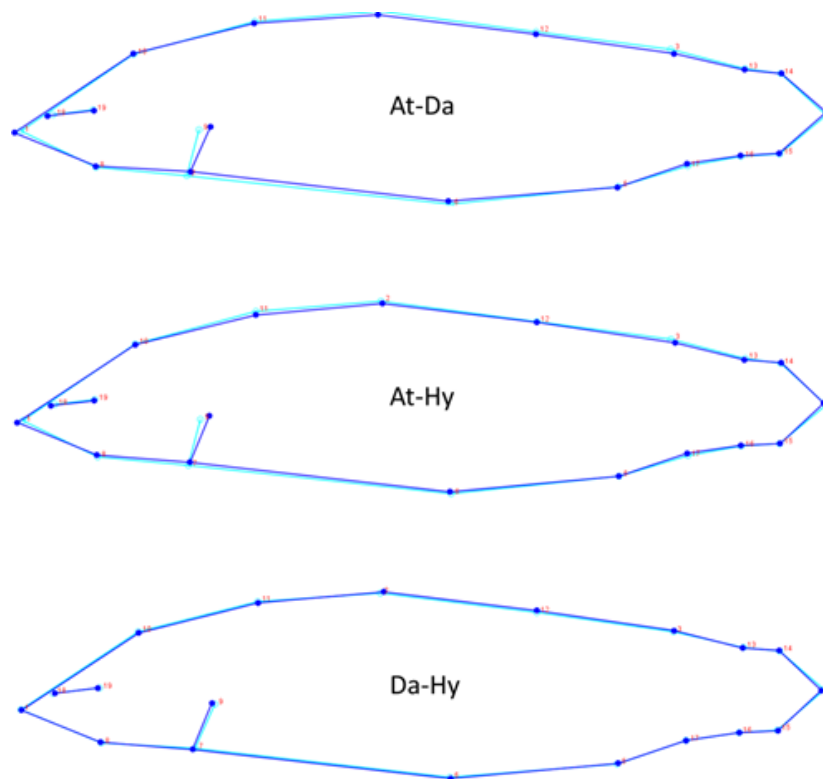

Figure 23. Shape variation between pairs of groups according to DFA. Light blue outline represents average shape of first mentioned lineage and dark blue outline represents average shape of the second lineage. At – Atlantic lineage, Da – Danubian lineage, Hy – hybrids

Procrustes distances were the same for CVA and DFA. Permutation test p-value for both analyses was statistically significant for shape differences between AT and DA lineages, as well as between AT individuals and hybrids (Table 19).

The value of the Procrustes variance for overall disparity was 0.0005. The results of the Procrustes variance for each group separately (AT, DA and Hy) and for pairs of groups (AT-DA, AT-Hy and DA-Hy) are shown in Table 20. The greatest variance for each group separately was shown within AT lineage (6.9000E-4). To determine whether this variance originates from different habitat conditions, DFA was additionally performed for individuals of the AT lineage from the “Vrabac” fish farm and two individuals from the wild. The results of this analysis were not statistically significant ($p = 0.085$).

The results of the Procrustes variance for pairs of groups was statistically significant only between AT individuals and hybrids ($p = 0.0080$).

PCA results along the first two principal components showed that there was variation in head length and body height in all three groups. However, body height was less variable in AT lineage individuals compared to DA lineage individuals and hybrids (Figures 24, 25, 26).

Table 19. Procrustes distances and permutation test p-values shown for pairs of groups. CVA – Canonical Variate Analysis, DFA – Discriminant Function Analysis

	CVA		DFA			
	Procrustes distance	Permutation test (p-value)	Procrustes distance	Permutation test (p-value)	T-square	T-square (p-value)
AT-DA	0.0144	0.0015	0.0144	0.0020	965.108	0.0290
AT-Hy	0.0121	0.0007	0.0121	< 0.0001	251.518	< 0.0001
DA-Hy	0.0060	0.3597	0.0060	0.6970	50.6808	0.6970

Table 20. Pairwise comparison of Procrustes variance between groups. Values of the observed pairwise absolute differences (distances) among group are shown under diagonale. p-values associated with pairwise differences are shown above diagonale. AT – Atlantic lineage, DA – Danubian lineage, Hy – hybrids, group-specific values show variance within each lineage separately

	AT	DA	Hy	group- specific
AT	-	0.0750	0.0080	6.9000E-4
DA	1.4600E-04	-	0.3890	5.4000E-4
Hy	1.9900E-04	5.2400E-05	-	4.9000E-4
Overall disparity	0.0005			

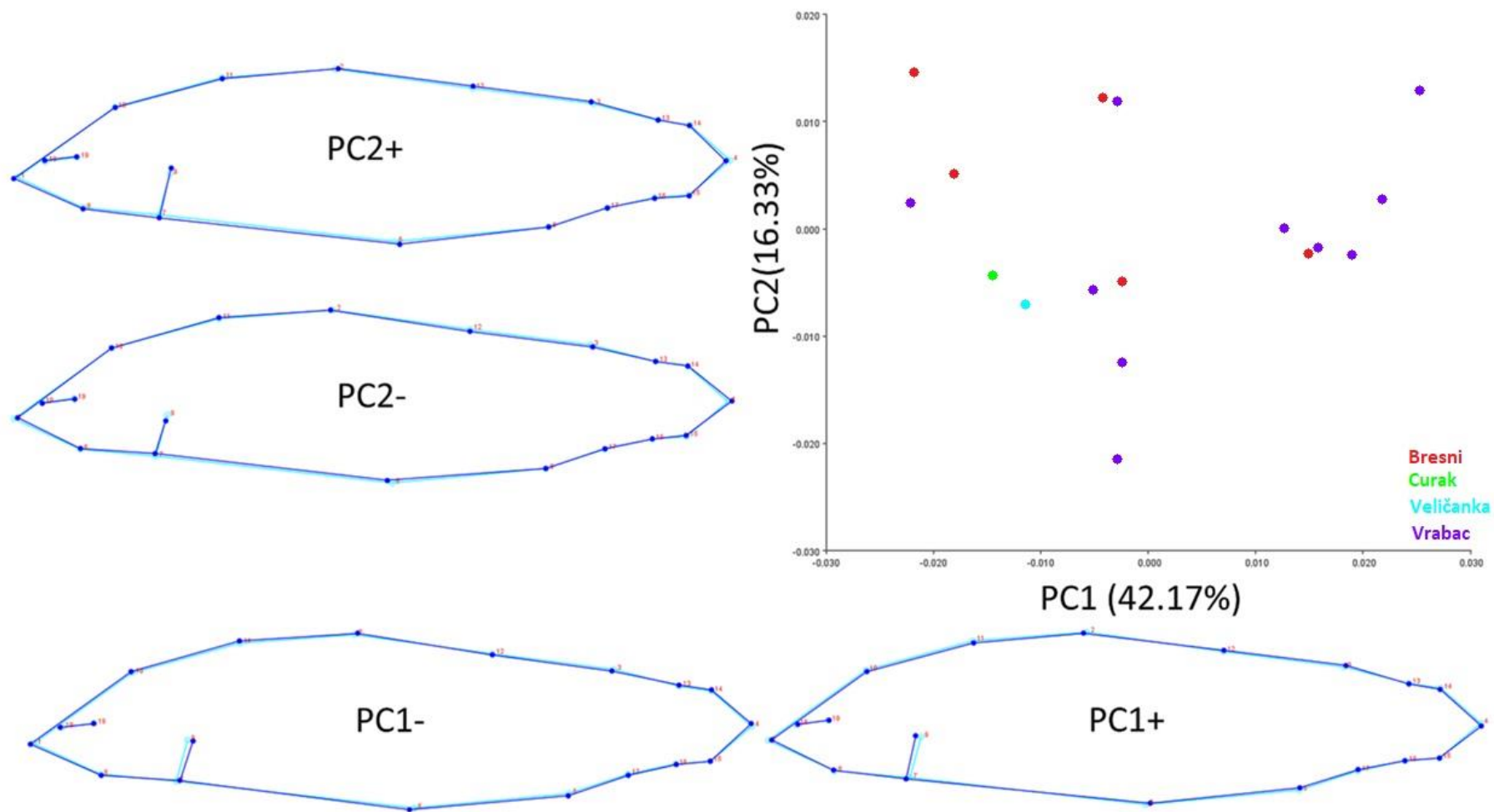

Figure 24. Scatterplot of the first two principal components of PCA depicting trout shape variation within Atlantic lineage. Wireframe graphs with 19 marked landmarks represent shape change along the first and second principal components, from negative to positive end. Light blue outlines represent the average shape and dark blue outlines represent shape changes.

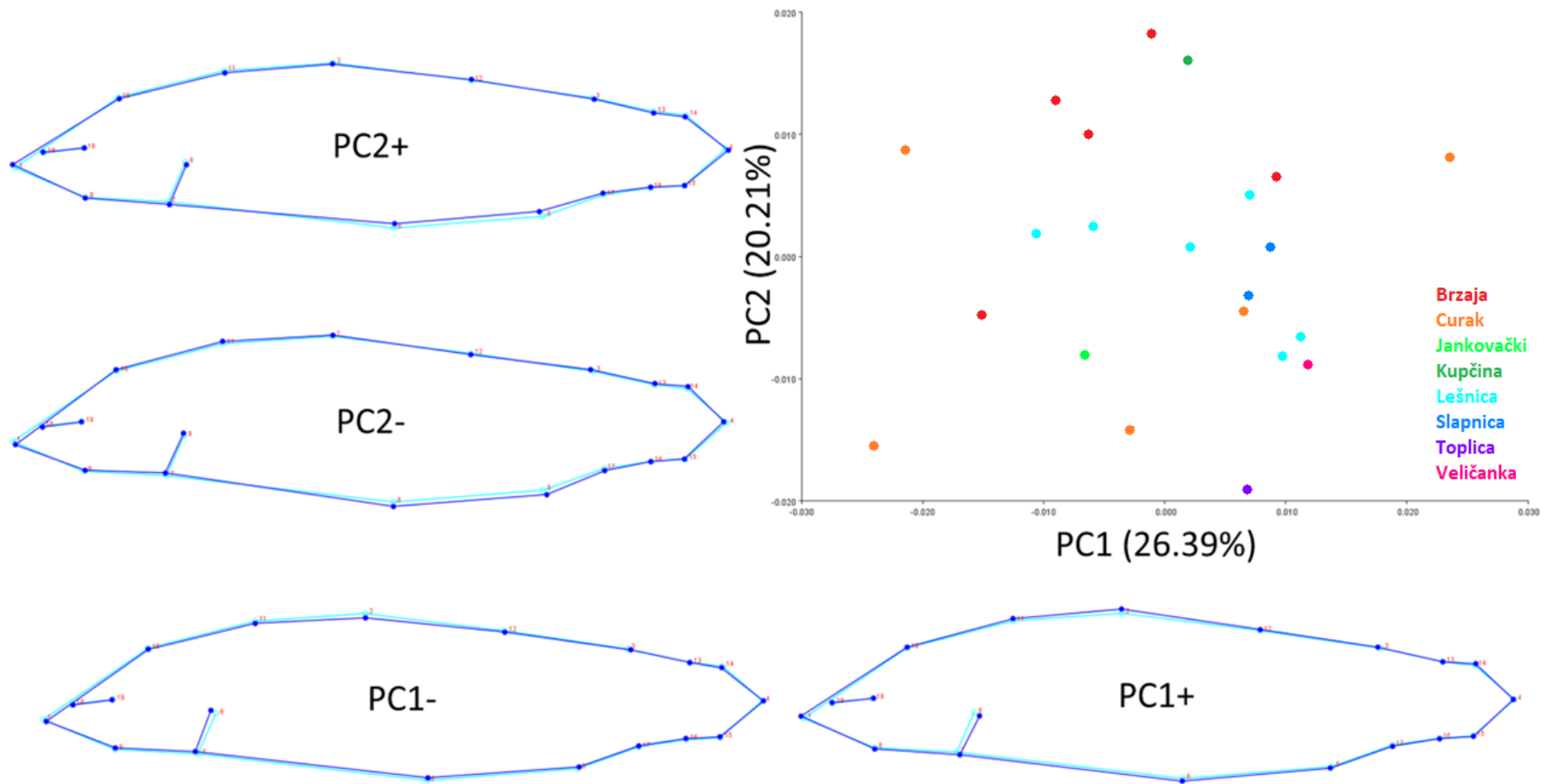

Figure 25. Scatterplot of the first two principal components of PCA depicting trout shape variation within Danubian lineage. Wireframe graphs with 19 marked landmarks represent shape change along the first and second principal components, from negative to positive end. Light blue outlines represent the average shape and dark blue outlines represent shape changes.

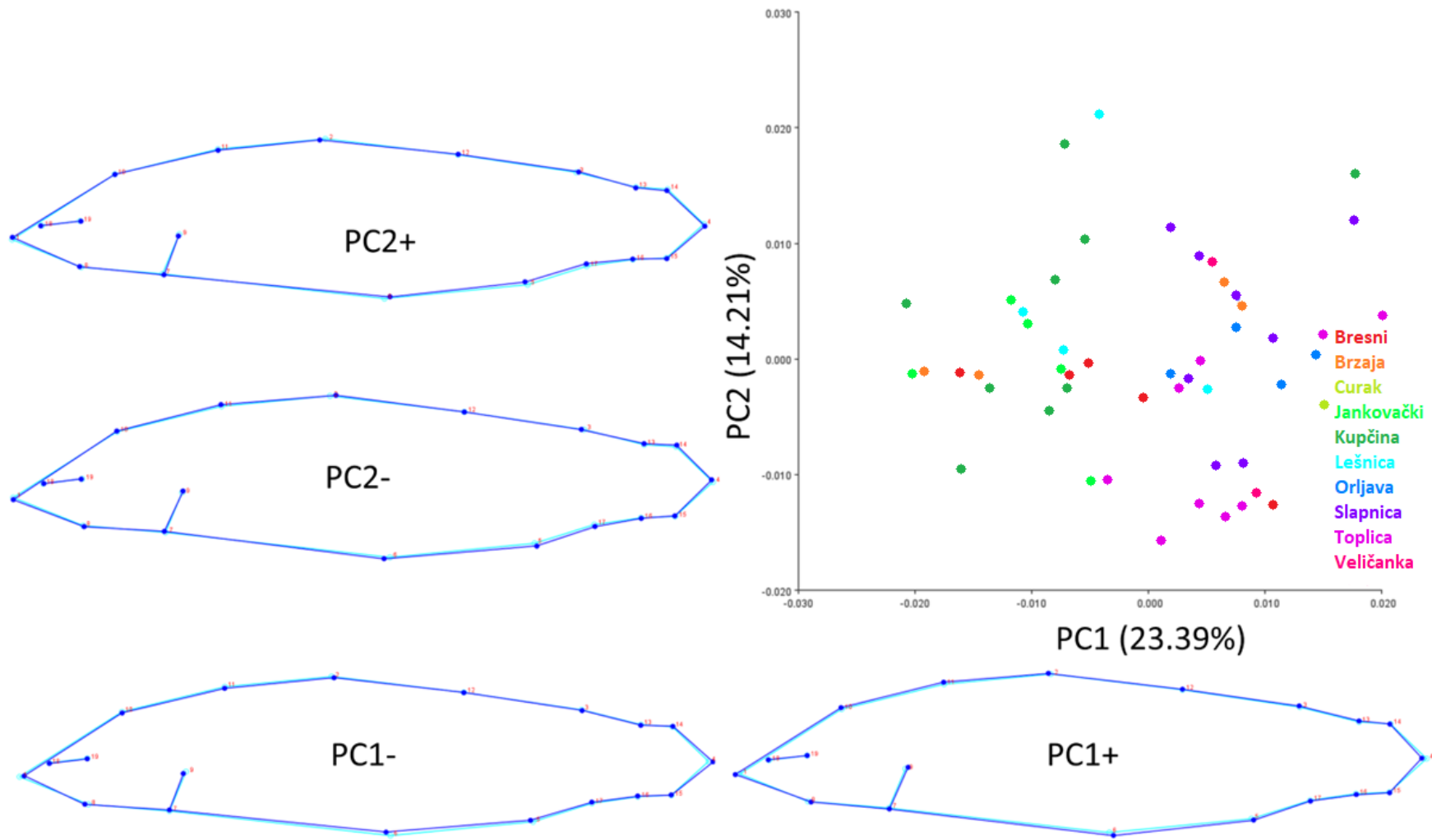

Figure 26. Scatterplot of the first two principal components of PCA depicting trout shape variation within hybrid group. Wireframe graphs with 19 marked landmarks represent shape change along the first and second principal components, from negative to positive end. Light blue outlines represent the average shape and dark blue outlines represent shape changes.

5. DISCUSSION

Brown trout was described by Linnaeus (1758) and it represents an inexhaustible source of information about its life history, which, as proven by numerous scientific studies, is complex and still unresolved. Brown trout is an important fish for humans. Starting from the fact that it is used for consumption, and then that it has been cultivated since ancient times, all the way to its attractiveness when it comes to sport or recreational fishing. According to records, it is especially challenging for fly fishing, which was practiced by ancient Greeks, medieval Europeans, North Americans in the industrial period and by modern anglers throughout the world (Herd, 2002). Although it is described as a fish that quickly adapts to environmental conditions, the habitats it inhabits are certainly special, because brown trout lives in clear, clean, cold waters, mostly mountain fast rivers or streams, which are increasingly available today to people. Because of its “popularity”, brown trout is considered the 13th most widely introduced species (Fausch, 2007). The introduction of brown trout also occurs within its native range, where this species shows great morphological and genetic variability.

Human activities, intentional, or most often unintentional, are the main cause of the endangerment of many species, and the brown trout is no exception. Although its status as Least Concern (Freyhof, 2011) has been unchanged for a long time, ignoring the need for any form of protection, the status of indigenous populations of brown trout in the Western Balkans is worrying. That is why brown trout research during the 20th and 21st centuries were largely concentrated on studying its genetics and its genetic diversity. Of particular importance in the study of Balkan trout populations is the fact that the Balkan Peninsula is considered (in addition to the Apennine and Iberian Peninsulas) a refugial center, and therefore a center of diversity during the glaciations (Hewitt, 1996; 1999). Preserving the genetic diversity of certain species is extremely important and demands defining, planning and implementing appropriate conservation measures. Identification and maintenance, and therefore preservation, of genetic diversity within and among populations ensures the potential of the species to respond to certain environmental changes, as well as to evolve under their influence (Araguas et al., 2009). Brown trout is characterized by a significant level of genetic diversity, which has long caused confusion in research regarding its taxonomic status. Today it is generally accepted that there are eight phylogenetic lineages of brown trout

(Danubian-DA, Atlantic-AT, Mediterranean-ME, *marmoratus*-MA, Adriatic-AD, Tigris, Duero and Dades) defined as a complex of *Salmo cf. trutta*.

However, the significant genetic diversity of brown trout is represented at the inter-population level, which is the reason for the existence of genetically differentiated local populations. The loss of these unique populations can result in the eradication of a relatively large part of the genetic variability within the species (Laikre et al., 1999). When talking about the application of conservation measures, it primarily refers to the preservation of these local populations. The local genetic differentiation of brown trout populations and the need to regulate its conservation status is evidenced by extensive scientific research in the Balkans, i.e. neighboring countries of Croatia, such as Serbia, Slovenia, Bosnia and Herzegovina, Montenegro, Greece (Apostolidis et al., 1997; Marić et al., 2006; Tošić et al., 2014; 2016; Škraba Jurlina et al., 2017; 2020), but also in Austria (Duftner et al., 2003).

Stocking, in addition to habitat degradation and overfishing (Laikre and Ryman 1996), is a major threat to brown trout populations. Stocking is primarily considered a conservation and protection measure to prevent population decline or extinction. However, it is increasingly applied uncontrolled, with the aim of increasing the abundance of trout for fishing purposes. At the same time, the material used for stocking represents the fish farm populations and is most often allochthonous for the salmonid rivers that are stocked. As far as it is known, genetic research of fish farm populations is not regulated by any rules or laws and it is rarely, or almost never, carried out, which represents an important problem in the conservation of native brown trout populations.

The problem of stocking with non-native fish farm material has been observed in rivers in Croatia (Jadan et al., 2007; 2015; Ivić et al., 2021), but the existence of autochthonous brown trout populations, their genetic status and structure, as well as the degree of introduction of non-native lineages in this area have not been investigated in detail to date. The results of this research provided genetic and some morphological data on brown trout populations in the rivers of the Danube basin in the western and eastern parts of Croatia. Data on one farmed population in “Vrabac” fish farm were also examined.

In order to determine which phylogenetic lineages of brown trout exist in the investigated rivers of the Danube basin in Croatia, the CR mtDNA sequences were analyzed. The previous

research in the area of the Western Balkans defined Danubian phylogenetic lineage as native in the rivers of the Danube and Black Sea basins (Bernatchez, 1992; Sanz, 2018). An overview of haplotype distribution in the Danube basin of the Western Balkans indicated that Da1 is the most widespread haplotype and is considered ancestral in this area (Bernatches et al., 1992; Marić et al., 2006; Tošić et al., 2016; Simonović et al., 2017; Škraba Jurlina, 2020). The results of CR mtDNA analysis showed that in the rivers of Croatia the most numerous Danubian haplotype was Da1, and it was registered in more than half of the examined individuals (52%). Research has shown that this haplotype is present as the single one in only one locality – Jankovac-Stream. Da1 haplotype was completely absent at four localities: Bresni potok, Orjava, Brzaja and “Vrabac” fish farm, while in the remaining analyzed populations it was present together with other detected haplotypes (Da2, Da22 and/or At1). Such data indicate that the Da1 haplotype is autochthonous in the rivers of the Danube basin in Croatia, but its status is threatened by the presence of other non-native haplotypes.

The description of two novel Danubian haplotypes (subtypes) represents a contribution to the genetic diversity of the indigenous brown trout populations. One of them, Da1f, was described in all five individuals precisely in the population of Jankovac-Stream, indicating the importance of this river from the aspect of conservation. Another, Da1g haplotype, was described in the Toplica River population. Their phylogenetic position could not be clearly defined, because their relationship with the other, already known Da1 haplotypes, was described with low bootstrap values. However, this does not dispute their existence as novel haplotypes, because clear differences in relation to other Da1 haplotypes exist. Analysis of phylogenetic relationships showed a close relationship between Da1b and Da2c haplotypes. This data is significant because it calls into question the current nomenclature of these haplotypes, given that their close relationship is supported by their synapomorphy of T nucleotide at the 908 position in the control region, in contrast to other haplotypes' subtypes that hold C nucleotide at that position. Neither the authors of these two haplotypes, Dufner et al. (2003) and Baric et al. (2010), did not consider this fact when describing Da1b and Da2c haplotypes. Their nomenclature remains questionable and more detailed analyses of CR haplotypes are necessary to reach clear conclusions.

The second DA haplotype detected during this study is Da2. The presence of this haplotype was recorded in the rivers of Serbia (Marić et al., 2006, Simonović et al., 2015, Tošić et al. 2016), Bosnia and Herzegovina (Mrdak et al., 2012, Škraba et al., 2017), and

Montenegro (Mrdak et al., 2012), where its allochthonous character was established. The results of the presently reported study suggest the same for the Croatian rivers. As already stated in chapter 2.1.3. Da2 haplotype is considered native to the streams and rivers in southern Germany (Bernatchez 2001) and streams belonging to the Austrian part of the Danube drainage (Weiss et al., 2001). During the 19th century, the fish from southern Germany (then the Austro-Hungarian Empire) were introduced into various parts of Europe (Kohout et al., 2012), possibly also into nowadays Croatia. The first data on the presence of the Da2 haplotype in Croatia were published by Jadan et al. (2007), in the Gacka River, which belongs to the Adriatic basin. These authors considered the autochthonous character of the Da2 haplotype, basing this view on the geological past of the Gacka River, which indicates that once this river belonged to the Danube River basin. Nevertheless, the autochthonous character of the Da2 haplotype in the rivers of Croatia is unlikely. Apart from stocking in the 19th century, the same authors also reported data on the stocking of the Gacka River with trout from Italian, Bosnian, and Croatian fish farms since 1970. As a confirmation of the introduction, the presence of the At1 haplotype in this river, as well as the complete absence of the expected AD lineage, was shown. Until now, it is not known that the Da2 haplotype is found as a single, private allele in a river of the Danube basin, although it is widely distributed in it. The presence of the Da2 haplotype as a single one was detected only in the population of brown trout from the Vrijeka River in the Fatničko karst field in Herzegovina, which belongs to the Adriatic basin (Mrdak, 2011). In this study, the Da2 haplotype was established in seven localities, along with Da1, Da22 and/or At1 haplotypes. It was most numerous in the populations of Lička Jesenica and Jankovac-Lake, where it dominated. Although Simonović et al. (2017) considered Da1 as a unique haplotype in completely isolated headwater sections of the sinking river Lička Jesenica, this research showed that only one individual in the Lička Jesenica carried Da1 haplotype, while all the others carried Da2 haplotype. In Jankovac-Lake, seven individuals carried the Da2 haplotype, and only one Da1. Bearing in mind that Jankovac-Lake is located in the center of a very attractive picnic area, stocking for the purpose of recreational fishing is the most likely explanation for the presence of this haplotype in it.

Haplotype Da22 is the third DA haplotype present in three rivers – Veličanka, Orljava and Brzaja. This haplotype was until recently, only native to the Lohnbach and Daglesbach rivers in Austria (Duftner et al., 2003). Based on the distribution and frequency of this haplotype in the Una River drainage, Škraba et al. (2017) described this haplotype as

autochthonous to the area, which represents the first such discovery for the Balkans as well as the area south of the Alps. Based on the results of this research, no definitive conclusion can be made about the character of the Da22 haplotype in the rivers of Croatia. In the Veličanka River, the Da22 haplotype is present together with the Da1 and At1 haplotypes, while in the River Brzaja it is present with the Da2 and At1 haplotypes. The exception is the Orłjava River, in which the Da22 haplotype is present as the only haplotype. Although it is the least numerous compared to the other haplotypes, its presence in the Orłjava River as a single haplotype may indicate its potentially autochthonous character. This is also supported by the connection of all three rivers, considering that both Veličanka and Brzaja flow into the Orłjava and that only in that system (Veličanka-Orłjava-Brzaja) the Da22 haplotype is present. Nevertheless, future similar findings of a single occurrence of Da22 in isolated headwater sections are needed in order to resolve the dilemma about its character and clarify its evolutionary history. The presence of the Da22 haplotype with other non-native haplotypes in the rivers of the Danube basin in Croatia strongly indicates to their hatchery origin, which agrees with the results of research in other localities of the Western Balkans (Simonović et al., 2015).

The presence of non-native Atlantic phylogenetic lineage individuals was recorded in the eight analyzed populations. Among them, one population was analyzed within a fish farm. Apart from the allochthonous character of the described Da haplotypes and their negative impact on the autochthonous brown trout gene pool, the introduction of individuals of the AT haplogroup throughout the Western Balkans is considered the main cause of the loss of the native genetic diversity of brown trout populations (Marić et al., 2006; Jadan, 2007; Mrdak, 2011; Simonović et al., 2017; Škraba Jurlina et al., 2020). Within the AT haplogroup, the At1 haplotype is the most widespread, as shown by the results of this research – all individuals of the AT phylogenetic lineage that were detected were exclusively of the At1 haplotype. Individuals of this lineage that are present in the natural watercourses of the Danube basin in the Western Balkans are identified with cultivated, fish farm individuals, which were either introduced or, more rarely, escaped from hatcheries into the waters inhabited by native brown trout populations. Uncontrolled stocking of this lineage, as easy or the only one available, has a negative impact on the native "pure" populations of brown trout both at the genetic and ecological levels (Škraba et al., 2020; Piria et al., 2022). The results of this research showed that all analyzed individuals from the "Vrabac" fish farm were of the At1 haplotype. This fish farm has a well-known and long tradition of breeding brown trout, whose genetic status was

unknown until now. Given that it is located in the headwaters of the Kupčina River, the presence of individuals of the At1 haplotype together with the Da1 haplotype in this river was not surprising.

As there is no reproductive isolation between the phylogenetic lineages of brown trout, and the data obtained by the analysis of CR mtDNA are informative in terms of inheritance by only one, maternal line, the analysis of the LDH-C1 nuclear locus enabled the assessment of hybridization between different lineages (haplogroups). It was shown that in the populations in which the AT haplogroup is present, hybridization with individuals of the DA haplogroup occurred, except for the population from the fish farm. In this population, all analyzed individuals were homozygous for the LDH-C*90 allele on both the maternal and paternal lines, which coincides with their CR mtDNA status as AT haplogroup. Analysis of the LDH-C1 locus showed that as many as 76 brown trout originate from parents belonging to different haplogroups – individuals defined as DA haplogroup according to CR mtDNA were homozygous for the LDH-C*90 allele (characteristic of AT haplogroup), while individuals of AT haplogroups were homozygous for the LDH-C*100 allele (characteristic of the DA haplogroup). This state of the population indicates the cross-breeding of trout in the F1 generation, which can be a confirmation of long-term uncontrolled stocking, which led to a strong introgression of non-native genetic material into the autochthonous, and thus seriously damaged the unique genetic diversity of brown trout in the majority of the Croatian streams. Even in Jankovac-Stream, where all individuals are of the Da1 haplotype, cross-breeding with the At1 haplotype was recorded, except for one that was homozygous for the LDH-C*100 allele. All the above data imply a long history of stocking with brown trout of the hatchery origin, which is why it is necessary to genotype remaining brown trout stock from inland waters, as well as to set the national legislation in a way that would introduce the mandatory genotyping of brown trout stocks from hatcheries and to mark and register native brood fish, which is still weakly enforced in Croatia.

The analysis of microsatellite loci showed a decrease in genetic variability in the Orłjava River population. This could be justified by the presence of a small number of individuals all of Da22 haplotype. Examination of the bottleneck effect in this population showed a deviation from the L-shaped distribution of allelic frequencies, indicating a more recent bottleneck effect. Nevertheless, due to the small number of samples, additional research on brown trout

in this river would be important in order to determine the status of the population, as well as the character of the Da22 haplotype.

The greatest genetic distance was recorded between the populations from “Vrabac” fish farm and Jankovac-Stream, which makes sense considering that these two populations are quite far apart and are located in two regions – the fish farm is located in the headwaters of the Kupčina River in the Žumberak region, while Jankovac-Stream is located in the area of Mt. Papuk. On the other hand, comparing with the analyses of CR mtDNA, these two populations are also different according to the lineage to which the individuals belong – all individuals from the fish farm are At1 haplotype, while all individuals from Jankovac-Stream are Da1 haplotype.

Due to the results of heterozygosity for the Orłjava River population, it would be expected that it stands out from the others, which this research did not show. Phylogenetic analysis showed that the Orłjava River population is closely related to the Brzaja River population. Apart from the fact that the Brzaja River is one of the largest tributaries of the Orłjava River, the population status of these two rivers is similar, taking into account that in the Brzaja, out of 9 individuals analyzed, 7 were defined as Da22 haplotypes, and that the Da1 haplotype was absent in both populations. The Veličanka River is another larger tributary of the Orłjava River, and the third river in which the Da22 haplotype was recorded (only one individual). However, its population is separated and positioned close to the population of the Toplica River.

The population from the river Slapnica clearly stands out compared to other populations. Based on the results of CR mtDNA, the presence of AT lineage individuals was not recorded in this population, so this population consists only of DA lineage individuals. Nevertheless, the presence of non-native Da2 and DA-AT hybrids indicates that the autochthonous character of the population is impaired. A more probable reason for the separation of this population is the possession of private alleles at the four analyzed microsatellite loci (Str73INRA, Ssa410Uos, SsaD190 and OMM1064), most of which are present in hybrids.

Analysis of microsatellite loci showed a large overlap between populations within one area, but also between populations located in distant areas. Such an example is represented by the close connection between the Čabranka River (Gorski Kotar) and Jankovac-Lake (Mt.

Papuk). These results confirm long-term uncontrolled stocking. However, the origin of the stocking material can only be assumed. The results of this research indicate that it is most likely that this level of overlapping occurs due to the increasing genetic similarity between populations, as a consequence of stocking from hatcheries that import and breed the same lineage (Atlantic) of brown trout. The results of population structure show that stocking has taken off and that the native stock of brown trout in the analyzed rivers of Croatia has been severely damaged. In the STRUCTURE program, all individuals are divided into two populations, regardless of geographic distribution. The analysis determined that one population consists of individuals belonging to the Danubian phylogenetic lineage, and the other population consists of individuals belonging to the Atlantic phylogenetic lineage and hybrids. In support of these data are the results of molecular variance for CR mtDNA haplotypes, which show small differences between populations (Table 9), most likely as a result of stocking with similar genetic material.

The bottleneck effect was not observed in the eight analyzed populations, which had a sufficient number of individuals to evaluate the effect. In the populations from the Orłjava River, as already mentioned, and Jankovac-Stream, there is a deviation from the L-shaped distribution of allelic frequencies according to the mode-shift test, which is an indicator of a more recent bottleneck effect. However, these results cannot be taken as certain, due to the small number of samples. Heterozygosity deficit was shown in the populations of the rivers Brzaja, Curak, Kupčina and “Vrabac” fish farm, which indicates expansion of the populations, most likely as a result of the introduction of the non-native farmed At1 haplotype.

In addition to genetic variability, brown trout is also characterized by distinct phenotypic variability, which enables the phylogenetic lineages to be distinguished based on their morphological characteristics. Therefore, it is known that the Danubian phylogenetic lineage is characterized by the typical presence of black and red (orange) spots, while the Atlantic phylogenetic lineage is characterized by distinctly dark (black) spots and usually the absence of red spots. However, this description is not the most reliable to judge whether there are non-native lineages in a population. It is especially problematic to evaluate and recognize hybrids based on appearance alone, which was also shown during the morphometric analysis of the individuals in this research. Results of GM for Danube individuals, Atlantic individuals and their hybrids, published in the paper of Špelić et al. (2021), confirmed the existence of shape

variability between these three mentioned groups. The results showed that body height, head length, and eye size were the main differentiating characteristics between the Danubian trout lineage and hybrids on the one side and introduced individuals of Atlantic lineage on the other. Similarly, Simonović et al. (2007) used the method of discriminant analysis on distances between landmarks to determine that brown trout stock of the Atlantic lineage from the Trešnjica fish farm were clearly distinct from the wild, genetically pure, native brown trout of the Danubian lineage in the streams of western Serbia. Differentiation was possible by characters on the head (e.g., total head length, preocular length, lower jaw length, and ventral head length), medial fins (dorsal fin base and anal fin base lengths) and caudal peduncle (anterior height).

Almost insignificant variability of body height, head length, and eye size was observed between individuals of the Danube lineage and the hybrids, which is probably due to the fact that after hybridization they inhabit the same habitat together with the Danube lineage, reproduce and evolve with it. Slightly different results were obtained for shape variability in Mediterranean and Atlantic lineages and their hybrids (Monet et al., 2006; Lorenzoni et al., 2019) and show a significant shape distinction between hybrid trout and both parental populations, while hybrids were more like the native Mediterranean parental lineage populations.

Considering the phenotypic plasticity of brown trout, which is certainly the result of genetics, but also habitat conditions, differences between those raised in fish farms and those that live freely in natural watercourses exist in salmonid species (Fleming et al., 1994). Differences or similarities in shape variability between Atlantic trout from “Vrabac” fish farm and those found in rivers could indicate their fish farm origin. Atlantic trout showed the greatest shape variability compared to Danubian trout and hybrids, mostly in head length. However, the variability in body height was lower in the Atlantic lineage than in the other two groups. The DFA results also showed that there is no difference in shape variability between farmed and wild individuals. Variation in overall body shape is one of the best-known morphological responses in salmonids to flow regimes, and is heritable (Stelkens et al., 2012), so the above data can be additional proof of the introduction of allochthonous, farmed lineages of brown trout into wild, autochthonous populations and their negative influence on the unique gene pool.

The intentional release of non-native fish for commercial or recreational purposes has become common practice. Management procedures in many countries are less stringent for fish species compared to others, and in the Western Balkans, although there are potential management plan proposals, they seem to receive little attention. Combining the previous research mentioned in this paper, and including the results obtained by this research, the condition of the native brown trout populations in the Danube basin is seriously threatened. While in some small, isolated rivers there are still "pure" populations of brown trout (Tošić et al., 2014; 2016), which give hope for a possible recovery with artificial spawning and the formation of broodstocks, in the investigated rivers of the Danube basin in the western and of eastern Croatia, it seems that the native genetic diversity of trout rivers is on the edge of survival. Research of wild, native populations of brown trout on the territory of Croatia, determination of their condition and genetic structure in the future should be a priority in order to maintain and preserve their original genetic stocks. In order to protect brown trout populations in general, it is necessary, in addition to the above information, to carry out a detailed assessment of the endangering factors that pose the risk of extermination of unique trout populations on the territory of Croatia, but also to define the conservation unit on which the conservation effort will be directed. Stocking with inadequate genetic material is a threatening factor for the wild population of brown trout, but the way in which non-native lineages become the only available material, from their import, cultivation and finally release into natural watercourses, requires serious checks and radical changes that will be clearly administrative and legally defined. It is of utmost importance to examine the genetic structure of brown trout grown in fish farms, as well as the stocks used for stocking, which, so far, has not been legally regulated or implemented as a necessary practice in any country of the Western Balkans. In order to recover the degraded status of the brown trout population, stocking is desirable. Nevertheless, in this sense, stocking would imply a controlled, strictly defined and planned approach, and the stocking material would be grown as a "foundation stock", which would correspond to the population under management in terms of genetic material and thus help maintain its genetic stock. On the other hand, if the genetic structure of the population has been investigated and defined, which describes it as a "pure" native unique to a certain locality, and as such it should be protected from the negative influence of fishing pressure, the introduction of a conditional or total "catch-and-release" regime (C&R) (Simonović et al., 2008) as mandatory legal protective measures is proposed as a significant possible solution that would ensure the self-sustainability of the trout stock without the need for stocking, but also the sustainability of fishing.

6. CONCLUSIONS

Based on the conducted genetic and certain additional morphological analyses of *Salmo cf. trutta* populations from the area of the Danube River basin in the western-continental and eastern part of Croatia, the following conclusions of the study can be made:

- Danubian (DA) and Atlantic (AT) phylogenetic lineages, defined by CR mtDNA, are present in the studied rivers of the Danube basin in Croatia. Four haplotypes were detected, of which Da1, Da2 and Da22 within the DA lineage and At1 within the AT lineage.
- Novel haplotypes Da1f (Accession Numbers MK675073) and Da1g (Accession Number MK675074) were described in the area of Mt. Papuk, and their final phylogenetic status must be further analyzed, because the results in this research was done with low bootstrap values compared to other haplotypes, although there are evident differences, namely the C → T transition at polymorphic position 853 in Da1f, and T → C transition at polymorphic position 662 in Da1g.
- The Da1 haplotype is considered autochthonous for the Danube basin of the Western Balkans, and in this study, it showed the highest abundance compared to the other three haplotypes. However, the complete absence of the Da1 haplotype was recorded in three brown trout populations, which is one of the indicators of the degraded condition of the brown trout population.
- The current nomenclature of Da1b and Da2c subtypes is debatable and should be verified, considering that they belong to different haplogroups (Da1 and Da2, respectively) and that the results of this study showed their close phylogenetic relationship, which is further supported by their synapomorphy of T nucleotide at the variable position 908 in the CR of mtDNA, in contrast to other haplotypes that hold C nucleotide at that position.
- The Da22 haplotype, which is present only in the Veličanka-Orljava-Brzaja system, is characterized as an allochthonous one, introduced from hatcheries for fishing

purposes. As a single haplotype, it is present in the Orjava River (into which the Veličanka and Brzaja flow). However, this haplotype was only recently characterized for the first time in the Balkan region as autochthonous only in the Una River basin (Škraba Jurlina et al., 2017). Further examination of this haplotype in the territory of Croatia is proposed, in order to establish its character (autochthonous or allochthonous) and to define its evolutionary history.

- Hybridization between trout DA and AT lineages was established in all natural watercourses. Analysis of the nuclear LDH-C1* locus indicated hybridization in the F1 generation, and thus a high degree of introgression of allochthonous genetic material into the original native gene pool. The only "pure" population of brown trout was registered in the "Vrabac" fish farm and consists of individuals of the allochthonous At1 haplotype.
- The genetic structure of populations showed their great overlapping, both between spatially close ones and between geographically distant ones. This situation indicates a long-term uncontrolled stocking with allochthonous material that most likely originates from the same stocking material, namely uniform farmed trout of AT phylogenetic lineage.
- Shape variability was determined between DA and AT phylogenetic lineages of brown trout, mostly in body height, head length, and eye size. Atlantic trout are clearly separated from Danubian trout and hybrids.

7. REFERENCES

- Adams, D.C., Rohlf, F.J., Slice, D.E. (2004). Geometric morphometrics: Ten years of progress following the ‘revolution’. *Italian Journal of Zoology* 71 (1): 5-16. doi: 10.1080/11250000409356545
- Adams, D.C., Otarola-Castillo, E. (2013). Geomorph: an R package for the collection and analysis of geometric morphometric shape data. *Methods in Ecology and Evolution* 4: 393–399.
- Adams, D.C., Otarola-Castillo, E., Sherratt, E. (2014). Geomorph: Software for geometric morphometric analyses. R package version 2.0. Available at: <http://cran.r-project.org/web/packages/geomorph/index.html>. [Accessed: 22.12.2020].
- Ahn, C.S., Metallo, C.M. (2015). Mitochondria as biosynthetic factories for cancer proliferation. *Cancer and Metabolism* 3: 1.
- Allendorf, F., Leary, R., Spruell, P., Wenburg, J. (2001). The problems with hybrids: setting conservation guidelines. *Trends in Ecology and Evolution* 16 (11): 613-622.
- Anđelković, S.J. (1989). Tertiary fish of Yugoslavia-stratigraphic-paleontological-paleoecological study. *Paleontologia Jugoslavica* 38: 1-121.
- Apostolidis, A.P., Triantaphyllidis, C., Kouvatsi, A., Economidis, P.S. (1997). Mitochondrial DNA sequence variation and phylogeography among *Salmo trutta* L. (Greek brown trout) populations. *Molecular Ecology* 6: 531-542.
- Araguas, R. M., Sanz, N., Fernandez, R., Utter, F. M., Pla, C., Garcia-Marin, J. L. (2009). Role of genetic refuges in the restoration of native gene pools of brown trout. *Conservation Biology* 23: 871-878.
- Arias, J., Sánchez, L., Martínez, P. (1995). Low stocking incidence in brown trout populations from northwestern Spain monitored by LDH-5* diagnostic marker. *Journal of Fish Biology* 47: 170-176.
- Awise, J.C., Arnold, J., Ball, R.M., Bermingham, E., Lamb, T., Neigel, J.E., Reeb, C.A., Saunders, N.C. (1987). Intraspecific phylogeography: the mitochondrial DNA bridge between population genetics and systematics. *Annual Review of Ecology and Systematics* 18: 489-522.

- Balloux, F., Lugon-Moulin, N. (2002). The estimation of population differentiation with microsatellite markers. *Molecular Ecology* 11: 155-165.
- Bardakci, F., Degerli, N., Ozdemir, O., Basibuyuk, H. H. (2006). Phylogeography of the Turkish brown trout *Salmo trutta* L.: mitochondrial DNA PCR-RFLP variation. *Journal of Fish Biology* 68 (A): 36-55.
- Behnke, R. J. (1986). Brown trout. *Trout* 27: 42-47.
- Belkhir, L.C., Raufaste, N., Bonhomme, F. (1996-2004). GENETIX 4.05 Logiciel Sous Windows TM Pour la Génétique des Populations. In: Laboratoire Génome P, Interactions, CNRS UMR 5171, editor, Université de Montpellier II, Montpellier.
- Bernatchez, L., Guyomard, R., Bonhomme, F. (1992). DNA sequence variation of the mitochondrial control region among geographically and morphologically remote European brown trout *Salmo trutta* populations. *Molecular Ecology* 1: 161-173.
- Bernatchez, L., Danzmann, R. G. (1993). Congruence in control - region sequence and restriction – site variation in mitochondrial DNA of brook charr (*Salvelinus fontinalis* Mitchill). *Molecular Biology and Evolution* 10: 1002-1014.
- Bernatchez, L. (2001). The evolutionary history of brown trout (*Salmo trutta* L.) inferred from phylogenetic, nested clade, and mismatch analyses of mitochondrial DNA variation. *Evolution* 55 (2): 351-379.
- Berrebi, P., Povž, M., Jesenšek, D., Cattaneo, Berrebi, G., Crivelli, A.J. (2000). The genetic diversity of native, stocked and hybrid populations of marble trout in the Soča river, Slovenia. *Heredity* 85: 277-287.
- Bookstein, F.L. (1991). *Morphometric Tools for Landmark Data*. Cambridge University Press, Cambridge.
- Bookstein, F.L. (1996). Combining the Tools of Geometric Morphometrics. In: Marcus, L.F., Corti, M., Loy, A., Naylor, G.J.P., Slice, D.E. (eds) *Advances in Morphometrics*. NATO ASI Series, vol 284. Springer, Boston, MA. doi: 10.1007/978-1-4757-9083-2_12
- Boore, J.L. (1999). Animal mitochondrial genomes. *Nucleic Acids Research* 27 (8): 1767-1780. doi: 10.1093/nar/27.8.1767
- Bratic, A., Larsson, N.G., The role of mitochondria in aging. *J Clin Investig* 123: 951-7.

- Buj, I., Raguž, L., Marčić, Z., et al. (2020). Plitvice Lakes National Park harbors ancient, yet endangered diversity of trout (genus *Salmo*). *Journal of Applied Ichthyology*. 00: 1-18. doi: 10.1111/jai.14120
- Cadrin, S.X., Friedland, K.D., Waldman, J. (2005). *Stock identification methods: applications in fishery science*. Elsevier Academic Press, San Diego, CA.
- Cairney, M., Taggart, J. B., Hoyheim, B. (2000). Characterization of microsatellite and minisatellite loci in Atlantic salmon (*Salmo salar* L.) and cross-species amplification in other salmonids. *Molecular Ecology* 9: 2155-2234.
- Cavalcanti, M.G.P., Haller, J.W., Vannier, M.W. (1999). Three-dimensional computed tomography landmark measurement in craniofacial surgical planning: Experimental validation in vitro. *Journal of Oral and Maxillofacial Surgery* 57 (6): 690-694. doi: 10.1016/S0278-2391(99)90434-2.
- Chaiphongpachara T. (2018). Comparison of landmark and outline based geometric morphometrics for discriminating mosquito vectors in Ratchaburi Province, Thailand. *BioMed Research Int*: 1-10.
- Chandel, N.S. (2015). Evolution of mitochondria as signaling organelles. *Cell Metabolism* 22: 204-6.
- Cheng, Z., Ristow, M. (2013). Mitochondria and metabolic homeostasis. *Antioxidants & Redox Signaling* 2013; 19:240–2.
- Chereshnev, I.A., Skopets, M.B. (1990). *Salvethymus svetovidovi* gen. et sp. nova – a new endemic fish of the subfamily Salmoninae (Salmonidae) from Lake Elgygytgyn (Central Chukotka). *Voprosy Ichtiologii* 30 (2): 201-213
- Clabaut, C., Bunje, P.M.E., Salzburger, Meyer, A. (2007). Geometric morphometric analyses provide evidence for the adaptive character of the Tanganyikan cichlid fish radiations. *Evolution* 61 (3): 560-578. doi: 10.1111/j.1558-5646.2007.00045.x
- Consuegra, S., John, E., Verspoor, E. et al. (2015). Patterns of natural selection acting on the mitochondrial genome of a locally adapted fish species. *Genetics Selection Evolution* 47 (58). doi: 0.1186/s12711-015-0138-0
- Cornuet, J.M., Luikart, G. (1996). Description and power analysis of two tests for detecting recent population bottlenecks from allele frequency data. *Genetics* 144 (4): 2001-2014.

- Cortey, M., Pla, C., García-Marín, J.L. (2004). Historical biogeography of Mediterranean trout. *Molecular Phylogenetics and Evolution* 33: 831-844.
- Cortey, M., Vera, M., Pla, C., Garcia-Marin, J.L. (2009). Northern and southern expansions of Atlantic brown trout (*Salmo trutta*) populations during the Pleistocene. *Biological Journal of the Linnean Society* 97: 904-917.
- Cross, T.F. (1989). Genetics and the management of the Atlantic salmon. Atlantic Salmon Trust, Pitlochry.
- De Munter, A. (2016). Fact Sheets on the European Union: The Western Balkans. European Parliament.
- Doadrio, I., Perea, S., Yahyaoui, A. (2015). Two new species of Atlantic trout (Actinopterygii, Salmonidae) from Morocco. *Graellsia* 71: e031.
- Dorofeeva, E.A. (1989). The basic principles of classification and phylogeny of the salmonid fishes (Salmoniformes, Salmonoidei, Salmonidae). *Biology and Phylogeny of Fishes*, (Korovina, V.M., ed.). St. Petersburg: Proceedings of Zoological Institute, USSR Academy of Sciences (in Russian), pp. 5-16.
- Doublet, V., Souty-Grosset, C., Bouchon, D., Cordaux, R., Marcadé, I. (2008). A thirty-million-year-old inherited heteroplasmy. *PLoS ONE* 3 (8): e2938.
- Dryden, I.L., Mardia, K.V. (1998). *Statistical Shape Analysis*. John Wiley and Sons, New York.
- Duftner, N., Weiss, S., Medgyesy, N., Sturmbauer, C. (2003). Enhanced phylogeographic information about Austrian brown trout populations derived from complete mitochondrial control region sequences. *Journal of Fish Biology* 62: 427-435.
- Earl, D. A., vonHoldt, B. M. (2012). STRUCTURE HARVESTER: a website and program for visualizing STRUCTURE output and implementing the Evanno method. *Conservation Genetics Resources* 4 (2): 359-361
- Elliott, J. M. (1994). *Quantitative ecology and the brown trout*. Oxford Series in Ecology and Evolution, Oxford University Press, Oxford, Great Britain, pp. 286.
- Estoup, A., Presa, P., Krieg, F., Vaiman, D., Guyomard, R. (1993). (CT)_n and (GT)_n microsatellite: a new class of genetic markers for *Salmo trutta* L. (brown trout). *Heredity* 71: 488-496.

- Excoffier, L., Lischer, H. E. (2010). Arlequin suite ver 3.5: a new series of programs to perform population genetics analyses under Linux and Windows. *Molecular ecology resources* 10 (3): 564-567.
- Fan, H., Chu, J.Y. (2007). A brief review of short tandem repeat mutation. *Genomics, Proteomics and Bioinformatics* 5 (1): 7-14.
- Fausch, K.D. (2007). Introduction, establishment, and effects of non-native salmonids: considering the risk of rainbow trout invasion in the United Kingdom. *Journal of Fish Biology*, 71: 1-32. doi: 10.1111/j.1095-8649.2007.01682.x
- Ferguson, A., Fleming, C.C. (1983). Evolutionary and taxonomic significance of protein variation in the brown trout (*Salmo trutta* L.) and other salmonid fishes. In *Protein polymorphism: adaptive and taxonomic significance* 24: 84-99.
- Ferguson, A. (1989). Genetic differences among brown trout, *Salmo trutta*, stocks and their importance for the conservation and management of the species. *Freshwater biology* 21 (1): 35-46.
- Fleming, I.A., Jonsson, B., Gross, M.R. (1994). Phenotypic divergence of sea-ranched, farmed, and wild salmon. *Canadian Journal of Fisheries and Aquatic Sciences* 51: 2808-2824.
- Ford-Lloyd, G. (1996). *Measuring genetic variation using molecular markers*. University of Birmingham, Kevin Painting, IPGRI, Rome.
- Fraser, D.J., Weir, L.K., Bernatchez, L., Hansen, M.M., Taylor, E.B. (2011). Extent and scale of local adaptation in salmonid fishes: review and meta-analysis. *Heredity* 106 (3): 404-420.
- Freyhof, J. (2011). *Salmo trutta*. The IUCN Red List of Threatened Species 2011: e.T19861A9050312. doi: 10.2305/IUCN.UK.2008.RLTS.T19861A9050312.en.
- Fridjonsson, O., Olafsson, K., Tompsett, S. et al. (2011). Detection and mapping of mtDNA SNPs in Atlantic salmon using high throughput DNA sequencing. *BMC Genomics* 12: 179. doi: 10.1186/1471-2164-12-179
- Froese, R., Pauly, D. (Eds) (2018). *FishBase: World Wide Web electronic publication*. Available at: www.fishbase.org [Accessed: 05.02.2023].
- Fruciano, C., Pappalardo, A.M., Tigano, C., Ferrito V. (2014). Phylogeographical relationships of Sicilian brown trout and the effects of genetic introgression on morphospace occupation. *Biological Journal of the Linnean Society* 112: 387-398.

- Fruciano, C. (2016). Measurement error in geometric morphometrics. *Development Genes and Evolution* 226: 139-158.
- Fruciano, C., Schmidt, D., Ramírez Sanchez, M.M., Morek, W., Valle, Z.A., Talijančić, I., Pecoraro, C., Legionnet, A.S. (2020). Tissue preservation can affect geometric morphometric analyses: a case study using fish body shape. *Zoological Journal of the Linnean Society* 188: 148-k162.
- Garcia-Marin, J. L., Jorde, P. E., Ryman, N., Utter, F., Pla, C. (1991). Management implications of genetic differentiation between native and hatchery populations of brown trout (*Salmo trutta* L.) in Spain. *Aquaculture* 95: 235-249.
- Garcia-Marin, J.L., Utter, F.M., Pla, C. (1999). Postglacial colonization of brown trout in Europe based on distribution of allozyme variants. *Heredity* 82: 46-56.
- Georgiev, S.B. (2003). On the origin of the Balkan Peninsula salmonids. *Ribarstvo* 61 (4): 147-174.
- Gissi, C., Iannelli, F., Pesole, G. (2008). Evolution of the mitochondrial genome of Metazoa as exemplified by comparison of congeneric species. *Heredity* 101: 301-20
- Giuffra, E., Guyomard, R., Forneris, G. (1996). Phylogenetic relationships and introgression patterns between incipient parapatric species of Italian brown trout (*Salmo trutta* L. complex). *Molecular Ecology* 5: 207-212
- Goudet, J. (2002). FSTAT version 2.9.3.2, a program to estimate and test gene diversities and fixation indices. Institute of Ecology, Lausanne, Switzerland.
- Grad Samobor. (2020). Ribolov na Bregančici. Available at: <https://www.samobor.hr/visit/ribolov-nabregancici-v26> [Accessed: 22. 11. 2022.].
- Gratton, P., Allegrucci, G., Sbordoni, V., Gandolfi, A. (2014). The evolutionary jigsaw puzzle of the surviving trout (*Salmo trutta* L. complex) diversity in the Italian region. A multilocus Bayesian approach. *Molecular Phylogenetics and Evolution* 79: 292-304.
- Gridelli, E. (1936). I pesci d'acqua dolce della Venezia Giulia. *Bollettino Della Società Adriatica Di Scienze Naturali in Trieste* 35: 7-140.
- Gur-Arie, R., Cohen, C., Eitan, L., Shelef, E., Hallerman, E., Kashi, Y.(2000). Abundance, non-random genomic distribution, nucleotide composition, and polymorphism of simple sequence repeats in *E. coli*. *Genome Research* 10: 61-70.

- Gyllensten, U., Wharton, D., Josefsson, A. et al. (1991). Paternal inheritance of mitochondrial DNA in mice. *Nature* 352: 255-257. doi: 10.1038/352255a0
- Hamilton, K.E., Ferguson, A., Taggart, J.B., Tomasson, T., Walker, A., Fahy, E. (1989). Post-glacial colonization of brown trout, *Salmo trutta* L.: Ldh-5 as a phylogeographic marker locus. *Journal of Fish Biology* 35 (5): 651-664.
- Hansen, M.M., Loeschcke, V. (1994). Effects of releasing hatcheryreared brown trout to wild populations. In: *Conservation Genetics* (eds Loeschcke, V., Tomiuk, J., Jain, S. K.). pp. 273-289.
- Hansen, M.M., Nielsen, E.E., Mensberg, K.L. (1997). The problem of sampling families rather than populations: relatedness among individuals in samples of juvenile brown trout *Salmo trutta* L. *Molecular Ecology* 6 (5): 469-474.
- Hansen, M.M., Nielsen, E.E., Ruzzante, D.E., Bouza, C., Mensberg, K.L.D. (2000a). Genetic monitoring of supportive breeding in brown trout (*Salmo trutta* L.), using microsatellite DNA markers. *Canadian Journal of Fisheries and Aquatic Sciences* 57 (10): 2130-2139.
- Hansen, M.M., Ruzzante, D.E., Nielsen, E.E., Mensberg, K.L.D. (2000b). Microsatellite and mitochondrial DNA polymorphism reveals life-history dependent interbreeding between hatchery and wild brown trout (*Salmo trutta* L.). *Molecular Ecology* 9 (5): 583-594.
- Hansen, M.M. (2002). Estimating the long-term effects of stocking domesticated trout into wild brown trout (*Salmo trutta*) populations: an approach using microsatellite DNA analysis of historical and contemporary samples. *Molecular Ecology* 11: 1003-1015.
- Herd, A. (2002). *The Fly: Two thousand years of fly fishing*. Medlar Press, Ellesmere, Shropshire.
- Hewitt, G.M. (1996). Some genetic consequences of ice ages, and their role in divergence and speciation. *Biological Journal of Linnean Society* 58: 274-276.
- Hewitt, G.M. (1999). Post-glacial re-colonization of European biota. *Biological Journal of Linnean Society* 68: 87-112.
- Hurst, C.D., Bartlett, S.E., Davidson, W.S., Bruce, I.J. (1999). The complete mitochondrial DNA sequence of the Atlantic salmon, *Salmo salar*. *Gene* 239 (2): 237-242. doi: 10.1016/S0378-1119(99)00425-4.

ITIS (2004). Integrated Taxonomic Information System. Available at: <http://www.itis.gov> [Accessed: 05.02.2023].

Ivić, L., Buj, I., Raguž, L., Marčić, Z., Čaleta, M., Zanella, D., Mustafić, P., Horvatić, S. (2021). Diversity and structure of trout populations (*Salmo sp.*, Salmonidae, Actinopteri) in the Žumberak-Samoborsko Gorje Nature Park in Croatia. *Fundamental and Applied Limnology* 194: 215-225.

Jadan, M., Čož-Rakovac, R., Tupić-Popović, N., Strunjak-Perović, I. (2007). Presence of unexpected phylogenetic lineages of brown trout *Salmo trutta* L. in Gacka River, Croatia. *Aquaculture Research* 38 (15): 1682-1685. doi: 10.1111/j.1365-2109.2007.01832.x

Jadan, M., Strunjak-Perović, I., Topić Popović, N., Čož-Rakovac, R.. (2015). Three major phylogenetic lineages of brown trout (*Salmo trutta* Linnaeus, 1758) in the Krka River system (Croatia) revealed by complete mitochondrial DNA control region sequencing. *Journal of Applied Ichthyology* 31 (1): 192-196.

Jarne, P., Lagoda, P.J.L. (1996). Microsatellites, from molecules to populations and back. *Trends in Ecology and Evolution* 11: 424-429.

Jevtić, J. (1989). *Ribarstvo. Praktikum. Naučna knjiga*, Beograd.

Johns, G.C., Avise, J.C. (1998). A comparative summary of genetic distances in the vertebrates from the mitochondrial cytochrome *b* gene. *Molecular biology and Evolution* 15: 1481-1490.

Kalember, Đ. (2011). Slatkovodno ribarstvo na tlu Republike Hrvatske od 1945. do 2007. godine. *Stočarstvo* 65 (2): 147-164. [Online] Available at: <https://hrcak.srce.hr/73899?lang=en> [Accessed: 04.02.2023].

Kalinovvski, S.T. (2002). How many alleles per locus should be used to estimate genetic distances? *Heredity* 88: 62-65.

Kanjuh, T., Tomić, S., Marić, A., Škraba Jurlina, D., Nikolić, V., Simonović, P. (2021). Trout *Salmo spp.* (Salmoniformes: Salmonidae) molecular diversity in streams on the southern slopes of the Stara Planina Mts. in Serbia. *Acta Zoologica Bulgarica* 73 (3): 425-429.

Karaman, S. (1924). *Pisces Macedoniae*. Split, pp 1-90. Karaman, S. (1927). *Salmonidi Balkana* [Salmonids of Balkans]. *Glasnik Naučnog Društva Skopje*, 2, 253-268.

- Karaman, S. (1938). Prilog poznavanju slatkovodnih riba Jugoslavije. Glasnik skopskog naučnog društva – Odeljenje prirodnih nauka, 18, 131-139.
- Kartavtsev, Y.P., Lee, J.S. (2006). Analysis of nucleotide diversity at the cytochrome b and cytochrome oxidase 1 genes at the population, species, and genus levels. Russian Journal of Genetics 42: 341-362. doi: 10.1134/S1022795406040016
- Kendall, A.W., Behnke, R.J. (1984). Salmonidae: development and relationships. Ontogeny and systematics of fishes. American Society of Ichthyologists and Herpetologists, Special Publication 1: 142-149.
- Kim, I.C., Kivveon, H.S., Kim, Y.I., Kim, C.B., Gye, M.C., Lee, W.=., Lee, Y.S., Lee, J.S. (2004). The complete mitochondrial genome of the javeline goby *Acanthogobius hasta* (Perciformes, Gobiidae) and phylogenetic consideration. Gene 336: 147-153.
- King, T.L., Eackles, M.S., Letcher, B.H. (2005). Microsatellite DNA markers for the study of Atlantic salmon (*Salmo salar*) kinship, population structure and mixed-fishery analyses. Molecular Ecology Notes 5 (1): 130-132.
- Klemetsen, A., Amundsen, P.A., Dempson, J.B., Jonsson, B., Jonsson, N., O'connell, M.F., Mortensen, E. (2003). Atlantic salmon *Salmo salar* L., brown trout *Salmo trutta* L. and Arctic charr *Salvelinus alpinus* (L.): a review of aspects of their life histories. Ecology of freshwater fish 12 (1): 1-59.
- Klingenberg, C.P. (2011). MorphoJ: an integrated software package for geometric Morphometrics. Molecular Ecology Resources 11: 353-357.
- Klingenberg, C.P. (2013). Visualizations in geometric morphometrics: how to read and how to make graphs showing shape changes. Hystrix, Italian Journal of Mammalogy 24: 15-24.
- Koo TK, Li MY. 2016. A guideline of selecting and reporting intraclass correlation coefficients for reliability research. Journal of Chiropractic Medicine 15: 155-163.
- Kohout, J., Jašková, I., Papoušek, I., Šedivá, A., Šlechta, V. (2012). Effects of stocking on the genetic structure of brown trout, *Salmo trutta*, in Central Europe inferred from mitochondrial and nuclear DNA markers. Fisheries Management and Ecology 19 (3): 252-263.
- Kottelat, M., Freyhof, J. (2007). Handbook of European freshwater fishes. Publications Kottelat.

- Kraytsberg, Y., Schwartz, M., Brown, T.A., Ebraldise, K., Kunz, W.S., Clayton, D.A., et al. (2004). Recombination of human mitochondrial DNA. *Science* 304: 981.
- Kuhta, M., Brkić, Ž. (2003). Hidrogeološka i hidrološka istraživanja na području Park šume Jankovac u Parku prirode Papuk. *Park prirode Papuk, Velika*.
- Kumar, S., Stecher, G., Li, M., Knyaz, C., Tamura, K. (2018). MEGA X: Molecular Evolutionary Genetics Analysis across Computing Platforms. *Molecular Biology and Evolution* 35 (6): 1547-1549. doi: 10.1093/molbev/msy096.
- Labak, I., Ozimec, S., Dumbović, V., Topić, J. (2011). Contribution to the knowledge of lichens of Papuk Nature Park (Slavonia, eastern Croatia). *Natura Croatica* 20 (1): 35-52.
- Ladoukakis, E.D., Zouros, E. (2001). Direct evidence for homologous recombination in mussel (*Mytilus galloprovincialis*) mitochondrial DNA. *Molecular Biology and Evolution* 18: 1168-75.
- Ladoukakis, E.D., Zouros, E. (2017). Evolution and inheritance of animal mitochondrial DNA: rules and exceptions. *The Journal of Biological Research (Thessalon)* 24: 2 doi: 10.1186/s40709-017-0060-4
- Laikre, L., Ryman, N. (1996). Effects on intraspecific biodiversity from harvesting and enhancing natural populations. *Ambio* 25 (8): 504-509.
- Laikre, L., Antunes, A., Apostolidis, A., Berrebi, P., Duguid, A., Ferguson, A., Garcia-Marin, H. L., Guyomard, R., Hansen, M. M., Hindar, K., Koljonen, M. L., Largiader, C., Martinez, P., Nielsen, E. E., Palm, S., Ruzzant, D., Ryman, N., Tryantaphyllidis, C. (1999). Conservation genetic management of brown trout (*Salmo trutta*) in Europe. Report by the Concerted action on identification, management and exploitation of genetic resources in the brown trout (*Salmo trutta*). Troutconcert, EU Fair CT97-3882.
- Langella, O. (2002). POPULATIONS 1.2. 28. Population genetic software (individuals or populations distances, phylogenetic trees). CNRS, France.
- Largiadèr, C. R., Scholl, A. (1996). Genetic introgression between native and introduced brown trout (*Salmo trutta* L.) populations in the Rhône River basin. *Molecular Ecology* 5: 417-426.
- Larkin, M.A., Blackshields, G., Brown, N.P., Chenna, R., McGettigan, P.A., McWilliam, H., ... Thompson, J.D. (2007). Clustal W and Clustal X version 2.0. *bioinformatics*, 23 (21): 2947-2948.

- Lee, W.J., Conroy, J., Howell, W.H., Kocher, T.D. (1995). Structure and evolution of teleost mitochondrial control regions. *Journal of Molecular Evolution* 41: 54-66. doi: 10.1007/BF00174041.
- Lee, H.C., Yin, P.H., Yu, T.N., Chang, Y.D., Hsu, W.C., Kao, S.Y., Chi, C.W., Liu, T.Y., Wei, Y.H. (2001). Accumulation of mitochondrial DNA deletions in human oral tissues: Effects of betel quid chewing and oral cancer. *Mutation Research* 493: 67-74.
- Lian, L.H., Koh, C.L. (2005). Genetic polymorphisms in mitochondrial DNA hypervariable regions I, II and III of the Malaysian population. *Asia Pacific Journal for Molecular Biology and Biotechnology* 13 (2): 79-85.
- Linnaeus, C. (1758). *Systema naturae per regna tria naturae, secundum classes, ordines, genera, species, cum characteribus, differentiis, synonymis, locis*. Editio decima, reformata. T. 1. Salvius, Holmiae. Iv, pp. 824.
- Lerceteau-Köhler, E., Weiss, S. (2006). Development of a multiplex PCR microsatellite assay in brown trout *Salmo trutta*, and its potential application for the genus. *Aquaculture* 258 (1): 641-645.
- Lo Brutto, S., Hristovski, N., Arculeo, M. (2010). Genetic divergence between morphological forms of brown trout *Salmo trutta* L. in the Balkan region of Macedonia. *Journal of Fish Biology* 76: 1220-1227.
- Lorenzoni, M., Carosi, A., Giovannotti, M., La Porta, G., Splendiani, A., Caputo Barucchi, V. (2019). Morphological survey as powerful detection tool of pure and local phenotypes in *Salmo trutta* complex. *Knowledge and Management of Aquatic Ecosystems* 420: 48.
- Lubieniecki, K.P., Saeed, D., So, M., Fujiki, K., Koop, B.F., Davidson, W.S. (2014). Evolution of Salmoniformes based on their mitochondrial genomes. Available at: http://www.ncbi.nlm.nih.gov/nuccore/NC_024032.1 [Accessed: 05.02.2023].
- Ma, H., O'Farrell, P.H. (2015). Selections that isolate recombinant mitochondrial genomes in animals. *Elife* 4: e07247.
- Magoulas, A., Tsimenides, N., Zouros, E. (1996). Mitochondrial DNA phylogeny and the reconstruction of the population history of a species: the case of the European anchovy (*Engraulis encrasicolus*). *Molecular Biology and Evolution* 13 (1): 178-190. doi: 10.1093/oxfordjournals.molbev.a025554

- Marić, S., Sušnik, S., Simonović, P., Snoj, A. (2006). Phylogeographic study of brown trout from Serbia, based on mitochondrial DNA control region analysis. *Genetics Selection Evolution* 38 (4): 411-430.
- Marić, A., Špelić, I., Radočaj, T., Vidović, Z., Kanjuh, T., Vilizzi, L., et al. (2022). Changing climate may mitigate the invasiveness risk of non-native salmonids in the Danube and Adriatic basins of the Balkan Peninsula (south-eastern Europe). *NeoBiota* 76: 135-161.
- Marcus, L.F., Corti M., Loy, A., Naylor, G.J.P., Slice, D.E. (1996). *Advances in morphometrics*. Plenum Press, New York.
- Marshall, G.T., Beaumont, A.R., Wyatt, R. (1992). Genetics of brown trout (*Salmo trutta* L.) stocks above and below impassable falls in the Conwy River system, North Wales. *Aquatic Living Resources* 5 (1): 9-13.
- Martinez, P., Arias, J., Castro, J., Sanchez, L. (1993). Differential stocking incidence in brown trout (*Salmo trutta*) populations from Northwestern Spain. *Aquaculture* 114: 203-216.
- McMeel, O.M., Hoey, E.M., Ferguson, A. (2001). Partial nucleotide sequences, and routine typing by polymerase chain reaction-restriction fragment length polymorphism, of the brown trout (*Salmo trutta*) lactate dehydrogenase, LDH-C1*90 and *100 alleles. *Molecular Ecology* 10 (1): 29-34. doi: 10.1046/j.1365-294X.2001.01166.x
- McPhail, J.D., Strouder, D.J. (1997). *Pacific Salmon and Their Ecosystems: Status and Future Options. The Origin and Speciation of Oncorhynchus*. New York, Chapman and Hall.
- Meier, K., Hansen, M.M., Bekkevold, D., Skaala, Ø., Mensberg, K.D. (2011). An assessment of the spatial scale of local adaptation in brown trout (*Salmo trutta* L.): footprints of selection at microsatellite DNA loci. *Heredity* 106 (3): 488-499.
- Meraner, A., Gratton, P., Baraldi, F. et al. (2013). Nothing but a trace left? Autochthony and conservation status of Northern Adriatic *Salmo trutta* inferred from PCR multiplexing, mtDNA control region sequencing and microsatellite analysis. *Hydrobiologia* 702: 201-213. doi:10.1007/s10750-012-1321-8
- Monet, G., Uyanik, A., Champigneulle, A. (2006). Geometric morphometrics reveals sexual and genotypic dimorphisms in the brown trout. *Aquatic Living Resources* 19: 47-57.
- Moritz, C., Dowling, T. E., Brown, W. M. (1987). Evolution of animal mitochondrial DNA: relevance for population biology and systematics. *Annual Review of Ecology and systematics* 18: 269-292.

- Mrdak, D. (2011). Pastrmke (*Salmo* L., 1758) rijeka Crne Gore – diverzitet, taksonomski status i filogenetski odnosi [Trout (*Salmo* L., 1758) of streams in Montenegro-diversity, taxonomic status and phylogenetic relationships]. Dissertation, University of Belgrade, Belgrade (in Serbo-Croatian).
- Mrdak, D., Nikolić, V., Tošić, A., Simonović, P. (2012). Molecular and ecological features of the soft-muzzled trout *Salmo obtusirostris* (Heckel, 1852) in the Zeta River, Montenegro. *Biologia* 67 (1): 222-233.
- Nielsen, E.E., Hansen, M.M., Loeschcke, V. (1997). Analysis of microsatellite DNA from old scale samples of Atlantic salmon: A comparison of genetic composition over sixty years. *Molecular Ecology* 6: 487-492.
- Norden, C.R. (1961). Comparative osteology of representative salmonide fish with particular reference to the grayling (*Thymallus arcticus*) and phylogeny. *Journal of the Fisheries Research Board of Canada* 18: 679-791.
- Nunes, M.D., Dolezal, M., Schlötterer, C. (2013). Extensive paternal mtDNA leakage in natural populations of *Drosophila melanogaster*. *Molecular Ecology* 22 (8): 2106-2117.
- Oakley, T.H., Phillips, R.B. (1999). Phylogeny of salmonine fishes based on growth hormone introns: Atlantic (*Salmo*) and Pacific (*Oncorhynchus*) salmon are not sister taxa. *Molecular Phylogenetics and Evolution* 11 (3): 381-393.
- Oleinik, A., Skurikhina, L., Kухlevskiy, A., Bondar, E. (2019). Genetic Differentiation of the Arctic Phylogenetic Group of Charr from Northeast Asia and North America. *Russian Journal of Genetics* 55: 349-359. doi: 10.1134/S1022795419030116.
- O'Reilly, P.T., Hamilton, L.C., McConnell, S.K., Wright, J.M. (1996). Rapid analysis of genetic variation in Atlantic salmon (*Salmo salar*) by PCR multiplexing of dinucleotide and tetranucleotide microsatellites. *Canadian Journal of Fisheries and Aquatic Sciences* 53 (10): 2292-2298.
- Osinov, A.G. (1984). Zoogeographical origins of brown trout, *Salmo trutta* (Salmonidae): data from biochemical genetic markers. *Journal of Ichthyology* 24: 10-23.
- Ostojić, A., Špoljar, M., Dražina, T. (2012). Impact of environmental factors on the diversity and number of living communities in the Jankovac stream (Nature Park Papuk). *Hrvatske Vode* 20 (79/80):11-22.

- Pandža, M. (2010). The Flora of the Papuk Nature Park (Slavonia, Croatia). *Šumarski list*, 134 (1-2): 43-44.
- Paterson, S., Piertney, S.B., Knox, D., Gilbey, J., Verspoor, E. (2004). Characterization and PCR multiplexing of novel highly variable tetranucleotide Atlantic salmon (*Salmo salar* L.) microsatellites. *Molecular Ecology Notes* 4 (2): 160-162.
- Payne, B.A., Wilson, I.J., Yu-Wai-Man, P., Coxhead, J., Deehan, D., Horvath, R., Taylor, R.W., Samuels, D.C., Santibanez-Koref, M., Chinnery, P.F. (2013). Universal heteroplasmy of human mitochondrial DNA. *Human Molecular Genetics* 22 (2): 384-90. doi: 10.1093/hmg/dds435..
- Petrović, Ž. (1969). Hidrogeološka istraživanja u slivu Veličanke. Institut za geološko-rudarska istraživanja i ispitivanja nuklearnih i drugih mineralnih sirovina, Beograd.
- Piria M., Špelić I., Rezić A., Šprem N. (2020). Morphological traits and condition of brown trout *Salmo trutta* from Žumberak and Samobor mountain streams. *Journal of Central European Agriculture* 21 (2): 231-245. doi: 10.5513/JCEA01/21.2.2460
- Piry, S., Luikart, G., Cornuet, J.M. (1999). BOTTLENECK: a program for detecting recent effective population size reductions from allele data frequencies. *Journal of Heredity* 90: 502-503.
- Pofuk, M., Zanella, D., Piria, M. (2017). An overview of the translocated native and non-native fish species in Croatia: pathways, impacts and management. *Management of Biological Invasions* 8: 425-435.
- Povž, M., Jasenšek, D., Berrebi, P., Crivelli, A. (1996). The marble trout, *Salmo marmoratus* Cuvier, 1817, in Soča River basin, Slovenia. Tour du Valat: Tour du Valat Publication.
- Presá, P., Pardo, B. G., Martínez, P., Bernatchez, L. (2002). Phylogeographic congruence between mtDNA and rDNA ITS markers in brown trout. *Molecular Biology and Evolution* 19 (12): 2161-2175.
- Pritchard, J.K., Stephens, M., Donnelly, P. (2000). Inference of population structure using multilocus genotype data. *Genetics* 155 (2): 945-959.
- Pustovrh, G., Snoj, A., Bajec, S. S. (2014). Molecular phylogeny of *Salmo* of the western Balkans, based upon multiple nuclear loci. *Genetics Selection Evolution* 46 (1): 1.

- R Core team. (2019). R: A language and environment for statistical computing. Vienna, Austria: R Foundation for Statistical Computing.
- Radojičić, J.M., Krizmanić, I., Kasapidis, P., Zouros, E. (2015). Extensive mitochondrial heteroplasmy in hybrid water frog (*Pelophylax spp.*) populations from Southeast Europe. *Ecol Evol* 5: 4529-41.
- Ryman, N., Jorde, P. E., Laikre, L. (1995). Supportive Breeding and Variance Effective Population Size. *Conservation Biology* 9(6): 1619-1628.
- Razpet, A., Sušnik, S., Jug, T., Snoj, A. (2007). Genetic variation among trout in the River Neretva basin, Bosnia and Herzegovina. *Journal of Fish Biology* 70: 94-110.
- Rexroad, C.E., Coleman, R.L., Hershberger, W.K., Killefer, J. (2002). Rapid communication: thirty-eight polymorphic microsatellite markers for mapping in rainbow trout. *Journal of Animal Science* 80 (2): 541-542.
- Rohlf, F.J. (1999). Shape statistics: Procrustes superimpositions and tangent spaces. *Journal of Classification* 16, 197–223.
- Rohlf, F.J. (2000). On the use of shape space to compare morphometric methods. *Hystrix, Italian Journal of Mammalogy* 11: 9–25
- Rohlf, F.J. (2017a). TPSDig2, version 2.30. Stony Brook NY: Department of Ecology and Evolution, State University of New York. Available at: <http://www.sbmorphometrics.org/> [aAccessed: 22.12.2020].
- Rohlf, F.J. (2017b). TPSrelw, version 1.69. Stony Brook NY: Department of Ecology and Evolution, State University of New York. Available at: <https://tpsrelw.software.informer.com/1.5/> [Accessed: 22.12.2020].
- Rohlf, F.J., Slice, D. (1990). Extensions of the Procrustes method for the optimal superimposition of landmarks. *Systematic Zoology* 39: 40-59.
- Rohlf, F.J., Marcus, L.F. (1993). A revolution in morphometrics. *Trends in Ecology and Evolution* 8: 129-132.
- Rohlf, F. J. (1996). Morphometric spaces, shape components, and the effects of linear transformations. Pages 117±129 in *Advances in Morphometrics* (L. F. Marcus, M. Corti, A. Loy, G. Naylor, and D. E. Slice, eds.). Proceedings of the 1993 NATO Advanced Studies Institute on Morphometrics in Il Ciocco, Italy. Plenum, New York.

- Roques, S., Sévigny, J.M., Bernatchez, L. (2002). Genetic structure of deep-water redbfish, *Sebastes mentella*, populations across the North Atlantic. *Marine Biology* 140: 297-307. doi:10.1007/s00227010070
- Sanz, N., García-Marín, J.L., Pla, C. (2002). Managing fish populations under mosaic relationships. The case of brown trout (*Salmo trutta*) in peripheral Mediterranean populations. *Conservation Genetics* 3: 385-400.
- Sanz, N. (2018). [Chapter 2] Phylogeographic history of brown trout: A Review.. In: Lobón-Cerviá J., Sanz N. (eds.) *Brown trout: Biology, ecology and management*. John Wiley and Sons, Hoboken, NJ, USA, pp. 17-63. doi: 10.1002/9781119268352
- Savić Pavićević, D., Matić, G. (2011). *Molekularna biologija I*. NNK International. Beograd
- Schlager, S. (2017). Morpho and Rveg – Shape Analysis in R. In: Zheng, G., Li, S., Székely, G. (eds.). *Statistical Shape and Deformation Analysis Methods, Implementation and Applications*. Amsterdam: Elsevier, pp. 217-256.
- Schlotterer, C. (2000). Evolutionary dynamics of microsatellite DNA. *Chromosoma* 109: 365-371.
- Schwartz, M, Vissing, J. (2002). Paternal inheritance of mitochondrial DNA. *The New England Journal of Medicine* 347: 576-80.
- Serbezov, D., Jorde, P. E., Bernatchez, L., Olsen, E. M., Vøllestad, L. A. (2012). Short-term genetic changes: evaluating effective population size estimates in a comprehensively described brown trout (*Salmo trutta*) population. *Genetics* 191 (2): 579-592.
- Simonović, P. (2001). *Ribe Srbije*. NNK, Zavod za zaštitu prirode Srbije i Biološki fakultet, Beograd, pp. 247.
- Simonović, P. (2001). *Ribe Srbije*. NNK, Zavod za zaštitu prirode Srbije i Biološki fakultet, Beograd, 247 pp.
- Simonović, P., Marić, S., Nikolić, V. (2007) Trout *Salmo spp.* complex in Serbia and adjacent regions of the western Balkans: reconstruction of evolutionary history from external morphology. *Journal of Fish Biology* 70 (Supplement C): 359-380. doi:10.1111/j.1095-8649.2007.01516.x

Simonović, P., Marić, S., Nikolić, V. (2008). Srednjeročni program upravljanja na delu ribarskog područja «SRBIJA ISTOK» za period od 2008-2012. Univerzitet u Beogradu, Biološki fakultet, Beograd, Srbija.

Simonović P. (2010). Uvod u ihtiologiju. Biološki fakultet, Univerzitet u Beogradu. Beograd, pp.316.

Simonović, P., Tošić, A., Vassilev, M., Apostolou, A., Mrdak, D., Ristovska, M., Kostov, V., Nikolić, V., Škraba, D., Vilizzi, L., Copp, G.H. (2013). Risk assessment of non-native fishes in the Balkans region using FISK, the invasiveness screening tool for non-native freshwater fishes. *Mediterranean Marine Science* 14 (2): 369-376. doi: 10.12681/mms.337

Simonović, P., Vidović, Z., Tošić, A., Škraba, D., Čanak Atlagić, J., Nikolić, V. (2015). Risks to stocks of native trout of the genus *Salmo* (Actinopterygii: Salmoniformes: Salmonidae) of Serbia and management for their recovery. *Acta Ichthyologica et Piscatoria* 45 (2): 161-173.

Simonović, P., Tošić, A., Škraba Jurlina, D., Nikolić, V., Piria, M., Tomljanović, T., Šprem, N., Mrdak, D., Milošević, D., Bećiraj, A., Dekić, R., Povž, M. (2017). Diversity of brown trout *Salmo cf. trutta* in the River Danube Basin of Western Balkans as assessed from the structure of their mitochondrial control region haplotypes. *Journal of Ichthyology* 57 (4): 603-616.

Sinha, K., Das, J., Pal, P.B., Sil, P.C. (2013) Oxidative stress: the mitochondria-dependent and mitochondria-independent pathways of apoptosis. *Arch Toxicol* 87: 1157-80.

Slettan, A., Olsaker, I., Lie, Ø., (1995). Atlantic salmon, *Salmo salar*, microsatellites at the SSOSL25, SSOSL85, SSOSL311, SSOSL417 loci. *Animal Genetics* 26: 281-282.

Škraba, D., Bećiraj, A., Šarić, I., Ićanović, I., Džaferović, A., Piria, M., Dekić, R., Tošić, A., Nikolić, V., Simonović, P. (2017). Haplotype Diversity of brown trout (*Salmo trutta* L.) populations from Una River drainage area in Bosnia and Herzegovina: Implications for conservation and fishery management. *Acta Zoologica Bulgarica* 69 (1): 25-30.

Škraba Jurlina, D., Marić, A., Mrdak, D., Kanjuh, T., Špelić, I., Nikolić, V., Piria, M., Simonović, P. (2020). Alternative life-history in native trout (*Salmo spp.*) suppresses the invasive effect of alien trout strains introduced into streams in the western part of the Balkans. *Frontiers in Ecology and Evolution* 8: 188.

Špelić, I., Rezić, A., Kanjuh, T., Marić, A., Maguire, I., Simonović, P., Radočaj, T., Piria, M. (2021). Application of the geometric morphometrics approach in the discrimination of

morphological traits between brown trout lineages in the Danube basin of Croatia. *Knowledge and Management of Aquatic Ecosystems* 422: 22.

Špoljar, M., Dražina, T., Ostojić, A., Miliša, M., Udovič, M., Štafa, D. (2012). Bryophyte communities and seston in a karst stream (Jankovac Stream, Papuk Nature Park, Croatia). *Annales De Limnologie – International Journal of Limnology* 48 (1): 125-138. doi: 10.1051/limn/2011057

Snoj, A., Melkič, E., Sušnik, S., Muhamedagić, S., Dovč, P. (2002). DNA phylogeny supports revised classification of *Salmothymus obtusirostris*. *Biological Journal of the Linnean Society* 77: 399-411.

Snoj, A. (2004). Filogenetska struktura postrvi (*Salmo trutta* L.) v Sloveniji. *Ribič, Glasilo Slovenskog ribištva. Ribiška sveza Slovenije* 10: 239-243.

Snoj A., Bogut, I., Sušnik, S. (2008). Evidence of a genetically distinct population of Vrljika softmouth trout *Salmo obtusirostris* Heckel evolved by vicariance. *Journal of Fish Biology* 72: 1945-1959.

Snoj, A., Marić, S., Berrebi, P., Crivelli, A. J., Shumka, S., Sušnik, S. (2009). Genetic architecture of trout from Albania as revealed by mtDNA control region variation. *Genetics Selection Evolution* 41: 22.

Snoj, A., Glamuzina, B., Razpet, A., Zablocki, J., Bogut, I., Lercetau-Köhler, E., Pojkić, N., Sušnik, S. (2010). Resolving taxonomic uncertainties using molecular systematics: *Salmo dentex* and the Balkan trout community. *Hydrobiologia* 651: 199-212.

Snoj, A., Marić, S., Bajec, S.S., Berrebi, P., Janjani, S., Schöffmann, J. (2011). Phylogeographic structure and demographic patterns of brown trout in North-West Africa. *Mol Phylogenet Evol* 61: 203-211.

Sømme, I. D. (1941). *Ørretboka*. Jakob Dybwads Forlag, Oslo.

Stalling, R.L., Ford, A.F., Nelson, D., Torney, D.C., Hildebrand, C.E., Moyzis, R.K. (1991). Evolution and distribution of (GT)_n repetitive sequences in Mammalian genomes. *Genomics* 10: 807-815.

Stearley, R.F., Smith, G.R. (1993). Phylogeny of the Pacific trouts and salmon (*Oncorhynchus*) and genera of the family Salmonidae. *Transactions of the American Fisheries Society* 122: 122-133.

- StatSoft, I.N.C. (2001). STATISTICA (data analysis software system), version 6. Tulsa, USA, 150.
- Stelkens, R.B., Jaffuel, G., Escher, M., Wedekind, C. (2012). Genetic and phenotypic population divergence on a microgeographic scale in brown trout. *Molecular Ecology* 21: 2896-2915.
- Suárez, J., Bautista, J.M., Almodóvar, A., Machordom, A. (2001). Evolution of mitochondrial control region in Palaearctic brown trout (*Salmo trutta*) populations: the biogeographical role of the Iberian Peninsula. *Heredity* 87: 198-206.
- Sušnik, S., Snoj A., Wilson, I., F., Mrdak, D., Weiss, S. (2007). Historical demography of brown trout (*Salmo trutta*) in the Adriatic drainage including the putative *S. letnica* endemic to Lake Ohrid. *Molecular Phylogenetic and Evolution* 44: 63-76.
- Taggart, J.B., Ferguson, A. (1986). Electrophoretic evaluation of a supplemental stocking programme for brown trout, *Salmo trutta* L. *Aquaculture Research* 17 (2): 155-162.
- Taler, Z. (1949). Coregonus farming in fishponds. *Ribarstvo Jugoslavije* 4: 17. (In Croatian).
- Tošić, A., Nikolić, V., Mrdak, D., Simonović, P. (2014). New mitochondrial DNA haplotype of brown trout *Salmo trutta* L. from Crni Timok drainage area in Serbia. *Turkish Journal of Fisheries and Aquatic Sciences* 14 (1): 37-42.
- Tošić, A., Škraba, D., Nikolić, V., Čanak Atlagić, J., Mrdak, D., Simonović, P. (2016). Haplotype diversity of brown trout in the broader Iron Gate area. *Turkish Journal of Zoology* 40: 655–662. doi: 10.3906/zoo-1510-54
- Treer, T. (1993). Upotrebljivost merističkih i morfometrijskih svojstava u razlikovanju ribljih populacija. *Ribarstvo* 48 (1): 13-26. Available at: https://hrcak.srce.hr/index.php?show=clanak&id_clanak_jezik=104931 [Accessed: 20 March 2019]
- Treer, T., Piria, M. (2019). *Osnove primijenjene ihtiologije*. Sveučilište u Zagrebu Agronomski fakultet, Zagreb, Hrvatska.
- Turan, D., Kottelat, M., Bektas, Y. (2011). *Salmo tigridis*, a new species of trout from the Tigris River, Turkey (Teleostei: Salmonidae). *Zootaxa* 2993: 23-33.
- Valentin, A.E., Penin, X., Chanut, J.P., Sévigny, J.M., Rohlf, F.J. (2008). Arching effect on fish body shape in geometric morphometric studies. *Journal of Fish Biology* 73: 623-638.

- Valentin, A.E., Penin, X., Chanut, J.P., Power, D., Sévigny, J.M. (2014). Combining microsatellites and geometric morphometrics for the study of redfish (*Sebastes spp.*) population structure in the Northwest Atlantic. *Fisheries Research* 154: 102-119. doi: 10.1016/j.fishres.2014.02.008
- Vera, M., Cortey, M., Sanz, N., Garcia-Marin, J.L. (2010). Maintenance of an endemic lineage of brown trout (*Salmo trutta*) within the Duero River basin. *Journal of Zoological Systematics and Evolutionary Research* 48: 181-187. doi: 10.1111/j.1439-0469.2009.00547.x.
- Vladykov, V.D. (1963). A review of salmonid genera and their broad geographical distribution. *Transaction of the Royal Society of Canada, Series IV, Section III*, 1: 459-504.
- Wallace, D.C. (1992). Diseases of the mitochondrial DNA. *Annual Review of Biochemistry* 61: 1175-1212.
- Wang, Y., Guo, R., Li, H., Zhang, X., Du, J., Song, Z. (2011). The complete mitochondrial genome of the Sichuan taimen (*Hucho bleekeri*): Repetitive sequences in the control region and phylogenetic implications for Salmonidae. *Marine Genomics* 4, 221-228. doi: 10.1016/j.margen.2011.06.003.
- Weber, J.L. (1990). Informativeness of human (dC-dA)_n·(dG-dT)_n polymorphisms. *Genomics* 7 (4): 524-530.
- Webster, M., Sheets, H.D. (2010). A practical introduction to landmark based geometric morphometrics. In: Alroy, J., Hunt, G. (eds.). *Quantitative methods in Paleobiology*. The Paleontological Society Papers, Cambridge Core, UK, pp. 163-188.
- Weiss, S., Schlötterer, C., Waidbacher, H., Jungwirth, M. (2001). Haplotype (mtDNA) diversity of brown trout *Salmo trutta* in tributaries of the Austrian Danube: massive introgression of Atlantic basin fish – by man or nature? *Molecular Ecology* 10 (5): 1241-1246.
- WenHsiung, L. (1997). *Molecular evolution*. Sinauer Associates Incorporated. Sunderland, MA, pp. 177-213.
- Winkler, K.A., Weiss, S. (2008). Eighteen new tetranucleotide microsatellite DNA markers for *Coregonus lavaretus* cloned from an alpine lake population. *Molecular Ecology Resources* 762: 1055-1058.
- Zane, L., Bargelloni, L., Patarnello, T. (2002). Strategies for microsatellite isolation; a review. *Molecular Ecology* 11: 1-16.

Zelditch, M.L, Swiderski, D.L, Sheets, H.D. (2004). *Geometric Morphometrics for Biologists: a primer*. Amsterdam, Elsevier, pp. 478.

Zhaoxia, C., Yuan, L., Ka Hou, C. (2010). Broader pattern of tandem repeats in the mitochondrial control region of Perciformes. *Chinese Journal of Oceanology and Limnology* 28: 785-794. doi: 10.1007/s00343-010-9091-5.

Autobiography

Tamara Kanjuh was born on February 18, 1992 in Bar (Montenegro), where she completed elementary school and high school. She entered the Faculty of Science and Mathematics of the University of Montenegro, Department of Biology, in 2010. She graduated in 2016 with an average grade of 8.11, and she defended her graduation thesis entitled “Selected ecological and morpho-anatomical features of the eel (*Anguilla anguilla* Linnaeus, 1758) from three different habitats in the territory of Montenegro” with a grade of 10. In the same year, she enrolled in master's studies at the Faculty of Biology, University of Belgrade, Department of Ecology, and in 2017 she graduated with an average grade of 9.62. She defended her master's thesis entitled “Status of autochthony of brown trout stock in the Republic of Serbia and conservation-fishery implications” with a grade of 10. In 2017, he enrolled in doctoral studies at the Faculty of Biology, University of Belgrade, Department of Morphology, Systematics and Phylogeny of Animals. In 2018, she was employed at the Department of Morphology, Systematics and Phylogeny of Animals at the University of Belgrade as a Researcher Intern. In October 2019, she was promoted to Associate Researcher. She participated in the national project “Evolution in heterogeneous environments: mechanisms of adaptation, biomonitoring and conservation of biodiversity” (project no. 173025, Ministry of Education, Science and Technological Development of the Republic of Serbia) and the international project “Climate change and invasive species – determining the impact on native freshwater biodiversity crustaceans and herds and their conservation (CLINEinBIOTa)” (project no. science for the foundation IP-06-2016).

Publications:

1. Kanjuh, T., Mrdak, D., Piria, M., Tomljanović, T., Joksimović, A., Talevski, T., Milošević, D. (2018). Relationship of otolith dimension with body length of European eel *Anguilla anguilla* (Linnaeus, 1758) from Adriatic catchment of Montenegro. *Acta Adriatica* 59 (1): 91-96.582-2017-KANJUH et al.
2. Škraba Jurlina, D., Marić, A., Karanović, J., Nikolić, V., Brkušani, M., Kanjuh, T., Mrdak, D., Simonović, P. (2019). Effect of the introgression of atlantic brown trout, *Salmo trutta*, into adriatic trout, *Salmo farioides* in a stream at the drainage area of the Adriatic Sea basin of Montenegro. *Acta Ichthyologica et Piscatoria* 48 (4): 363–372
3. Kanjuh, T., Marić, A., Piria, M., Špelić, I., Maguire, I., Simonović, P. (2020). Diversity of brown trout, *Salmo trutta* (Actinopterygii: Salmoniformes: Salmonidae), in the Danube River basin of Croatia revealed by mitochondrial DNA. *Acta Ichthyologica et Piscatoria* 50 (3): 291–300.
4. Simonović, P., Marić, A., Škraba Jurlina, D., Kanjuh, T., Nikolić, V. (2019). Determination of resident brown trout *Salmo trutta* features by their habitat characteristics in streams of Serbia. *Biologia Bratislava, Botany, Zoology and Cellular and Molecular Biology*. doi: 10.2478/s11756-019-00284-1
5. Kanjuh, T., Marić, A., Piria, M., Špelić, I., Maguire, I., Simonović, P. (2020). Diversity of brown trout, *Salmo trutta* (Actinopterygii: Salmoniformes: Salmonidae), in the Danube River basin of Croatia revealed by mitochondrial DNA. *Acta Ichthyologica et Piscatoria* 50 (3): 291–300.

6. Škraba Jurlina, D., Marić, A., Mrdak, D., Kanjuh, T., Špelić, I., Nikolić, V., Piria, M., Simonović, P. (2020). Alternative life-history in native trout (*Salmo spp.*) suppresses the invasive effect of alien trout strains introduced into streams in the Western part of the Balkans. *Frontiers in Ecology and Evolution* 8: 188.
7. Kanjuh, T., Tomić, S., Marić, A., Škraba Jurlina, D., Nikolić, V., Simonović, P. (2021). Trout *Salmo spp.* (Salmoniformes: Salmonidae) Molecular Diversity in Streams on the Southern Slopes of the Stara Planina Mts. in Serbia. *Acta Zoologica Bulgarica* 73 (3): 425–429.
8. Simonović, P., Ristić, R., Milčanović, V., Polovina, S., Malušević, I., Radić, B., Kanjuh, T., Marić, A., Nikolić, V. (2021). Effects of run-of-river hydropower plants on fish communities in montane stream ecosystems in Serbia. *River Research and Applications* 37 (5): 722–731.
9. Špelić, I., Rezić, A., Kanjuh, T., Marić, A., Maguire, I., Simonović, P., Radočaj, T., Piria, M., 2021. Application of the geometric morphometrics approach in the discrimination of morphological traits between brown trout lineages in the Danube basin of Croatia. *Knowledge and Management of Aquatic Ecosystems* 422: 22.
10. Piria, M., Špelić, I., Velagić, L., Lisica, I., Kanjuh, T., Marić, A., Maguire, I., Radočaj, T., Simonović, P. (2022). Feeding habits and diet overlap between brown trout lineages from the Danube basin of Croatia. *Fishes* 7 (4): 179.
11. Marić, A., Špelić, I., Radočaj, T., Vidović, Z., Kanjuh, T., Vilizzi, L., Piria, M., Nikolić, V., Škraba Jurlina, D., Mrdak, D., Simonović, P. (2022). Changing climate may mitigate the invasiveness risk of non-native salmonids in the Danube and Adriatic basins of the Balkan Peninsula (south-eastern Europe). *NeoBiota* 76: 135–161.

Congress announcements:

1. Kanjuh, T. Marić, A., Nikolić, V., Maguire, I., Špelić, I., Piria, M., Simonović, P. (2022). Brown trout (*Salmo cf. trutta*) from the Danube basin in Croatia – genetic structure of populations. Second Southeast European Ichthyological Conference (SEEIC), October 12-15, 2022, Supetar, Island Brač, Croatia.
2. Piria, M., Špelić, I., Kanjuh, T., Marić, A., Radočaj, T., Simonović, P. (2022). Discrimination of morphological traits between brown trout lineages from the Danube Basin of Croatia. European Inland Fisheries and Aquaculture Advisory Commission (EIFAAC) International Symposium – 2022 “Inland Fisheries and Aquaculture - Advances in Technology, Stock Assessment and Citizen Science in an Era of Climate Change”, 20th and 21st June 2022, Killarney, Co. Kerry, Ireland, Abstract Booklet, p. 37.
3. Simonović, P., Kanjuh, T., Špelić, I., Marić, A., Radočaj, T., Nikolić, V., Piria, M. (2022). Sustainability of indigenous brown trout *Salmo trutta* fishery in Serbia and Croatia. European Inland Fisheries and Aquaculture Advisory Commission (EIFAAC) International Symposium – 2022 “Inland Fisheries and Aquaculture - Advances in Technology, Stock Assessment and Citizen Science in an Era of Climate Change”, 20th and 21st June 2022, Killarney, Co. Kerry, Ireland, Abstract Booklet, p. 13.
4. Marić, A., Špelić, I., Radočaj, T., Kanjuh, T., Nikolić, V., Škraba Jurlina, D., Vidović, Z., Piria, M., Simonović, P. (2021). Risk screening of introduced and horizon salmonids of the Western Balkans under current and future climate conditions. Joint ESENIAS and DIAS Scientific Conference and 10th ESENIAS Workshop, 7-9.12.2021, virtual conference.

5. Piria, M., Špelić, I., Velagić, L., Lisica, I., Kanjuh, T., Marić, A., Simonović, P. (2019). Feeding preferences and diet overlap of introduced Atlantic and native Danube lineages of brown trout (*Salmo trutta*) from Croatia. XVII Congress of Ichthyology, 2-6. September 2019, Lausanne, Switzerland.
6. Kanjuh, T., Tošić, A., Špelić, I., Piria, M., Simonović, P., Maguire, I. (2018). Human influence on the native brown trout (*Salmo trutta*) genepool in the Continental Western Croatia. III International Congress on Applied Ichthyology and Aquatic Environment – HydroMedit, 8-11 November 2018, Volos, Greece.
7. Kanjuh, T., Tošić, A., Nikolić, V., Škraba Jurlina, D., Simonović, P. (2017). The most recent finding of Atlantic trout introgression in native brown trout, *Salmo trutta* L. stocks of Serbia. 1st Congress of Molecular Biologists of Serbia with international participation, 20-22 September 2017. Belgrade, Serbia. Book of Abstracts, p. 46.

APPENDICES

Appendix A. Analyzed microsatellite loci, their structure, expected length of PCR products and primers used for their amplification with appropriate fluorescent markers (FAM or NED).

Locus	Repeat motif	Dye	Primer sequences	Reference	Allelic size range (bp) (Lerceteau-Kohler and Weiss, 2006)
1° pair					
Str73INRA	(GT) _x TTATCT(GT) ₃	FAM	5'-CCTGGAGATCCTCCAGCAGGA-3' 5'-CTATTCTGCTTGTAAGTACCTA-3'	Estoup et al., 1993	138-144
Ssa410Uos	(GACA) _x	FAM	5'-GGAAAATAATCAATGCTGCTGGTT-3' 5'-CTACAATCTGGACTATCTTCTTCA-3'	Cairney et al., 2000	173-310
2° pair					
SsaD190	(TAGA) _x	FAM	5'-GGCATTGGAGGTAAGGACAC-3' 5'-CCAGACCACTGAACTTCTCATC-3'	King et al., 2005	115-157
SsaD71	(TAGA) _x	FAM	5'-AACGTGAAACATAAATCGATGG-3' 5'-TTAAGAATGGGTGTCCTATGAG-3'	King et al., 2005	183-239
3° pair					
Ssa85	(GT) ₁₄	FAM	5'-AGGTGGGTCCTCCAAGCTAC-3' 5'-ACCCGCTCCTCACTTAATC-3'	O'Reilly et al., 1996	101-113
SSsp2216	(GTTA) ₂₅	NED	5'-GGCCCAGACAGATAAACAAACACC-3' 5'-GCCAACAGCAGCATCTACACCCAG-3'	Paterson et al., 2004	133-215
4° pair					
OMM1064	(GATA) ₁₉	NED	5'-AGAATGCTACTGGTGGCTGTATTGA-3' 5'-TCTGAAAGACAGGTGGATGGTTCC-3'	Rexroad et al., 2002	163-286
SsoSL438	(AC) _x AT(AC) ₆	NED	5'-GACAACACACAACCAAGGCAC-3' 5'-TTATGCTAGGTCTTTATGCATTGT-3'	Slettan et al., 1995	89-109

Appendix B. Allelic frequencies by microsatellite loci for each population. Hexp. – expected heterozygosity, Hn.b. – objective heterozygosity, Hobs. – observed heterozygosity, SD – standard deviation, F_{IS} – fixation index, A – number of alleles per locus, LE – Mala Lešnica, CZ – Curak, ČA – Čabranka, JA – Jasenak, BP – Bresni potok, SL – Slapnica, KČ – Kupčina, KČR – “Vrabac” fish farm, LJ – Lička Jesenica, VE – Veličanka, OR – Orljava, TO – Toplica, JP – Jankovac-Stream, JJ – Jankovac-Lake, BR – Brzaja

Locus	Population															
	LE	CZ	ČA	JA	BP	SL	KČ	KČR	LJ	VE	OR	TO	JP	JJ	BR	
(N)	12	12	11	6	11	10	14	10	9	6	5	13	5	8	9	
Str73INRA																
138	0	0	0	0	0	0.600	0	0	0	0	0	0	0	0	0	0
170	0.708	0.833	0.591	0.333	0.136	0.150	0.857	0.500	0.778	0.500	0.400	0.385	1	0.438	0.944	
142	0	0	0	0	0	0	0	0	0	0.167	0	0.154	0	0	0	0
144	0.042	0	0.319	0	0.454	0	0.036	0.500	0	0	0	0.077	0	0.500	0	
146	0.250	0.083	0	0.417	0.364	0	0.071	0.450	0.222	0.250	0.400	0.154	0	0	0	
148	0	0.083	0.901	0.250	0	0.250	0	0	0	0	0	0.231	0	0.062	0	
150	0	0	0	0	0.046	0	0	0	0	0	0	0	0	0	0	
152	0	0	0	0	0	0	0	0	0	0.083	0	0	0	0	0	0.56
154	0	0	0	0	0	0	0.036	0	0	0	0	0	0	0	0	0
188	0	0	0	0	0	0	0	0	0	0	0.200	0	0	0	0	0
A	3	3	3	3	4	3	4	3	2	4	3	5	2	3	2	
F_{IS} (C&W)	-0.11	1	0.531	0.070	0.195	0.836	0.475	0.314	-0.23	0.070	0.467	-0.20	-----	0.382	0	
Hexp.	0.434	0.292	0.541	0.653	0.641	0.555	0.258	0.545	0.346	0.653	0.640	0.746	0	0.555	0.105	
Hn.b.	0.453	0.304	0.567	0.712	0.671	0.584	0.267	0.573	0.366	0.712	0.711	0.775	0	0.392	0.111	
Hobs.	0.500	0	0.273	0.667	0.546	0.100	0.143	0.400	0.444	0.667	0.400	0.923	0	0.375	0.111	
Ssa410Uos																
134	0	0	0	0	0	0	0	0	0	0	0	0	0	0.062	0	
160	0	0	0	0	0	0	0	0.500	0	0	0	0	0	0	0	
176	0	0	0	0	0	0	0	0	0	0	0	0.038	0	0	0	
180	0	0.417	0	0	0	0	0	0	0	0	0	0	0	0	0	

184	0.125	0	0.090	0.083	0	0	0	0	0	0	0	0	0	0	0
188	0	0	0	0	0	0	0	0	0	0	0	0.231	0	0	0
192	0	0	0	0	0	0	0	0	0	0	0	0	0	0.188	0
196/198	0	0	0.046	0.167	0.136	0.200	0	0	0	0	0	0	0	0	0
200	0.042	0	0	0	0.136	0	0.071	0	0.056	0	0	0	0	0	0.056
204/206	0.208	0.042	0.273	0	0	0	0.143	0	0.056	0	0	0	0	0	0
208/210	0.250	0.125	0	0.083	0.046	0	0.143	0.300	0	0.167	0	0	0	0	0.056
212/214	0.125	0.083	0	0	0	0.050	0	0.050	0	0	0	0.115	0	0	0.056
218	0	0.042	0	0.083	0	0	0.036	0.200	0	0	0	0.115	0.200	0	0.167
222	0.042	0	0	0	0.136	0	0.036	0	0	0	0	0.039	0	0	0.178
226	0.042	0.083	0.046	0.083	0	0.050	0.107	0	0.111	0.083	0.300	0	0.200	0	0.056
230	0	0	0	0	0.318	0	0	0.050	0	0.167	0.100	0	0	0.125	0
234	0	0	0.090	0.083	0.046	0	0.036	0	0	0	0.200	0.039	0.100	0.312	0.167
238	0	0.042	0.046	0.250	0	0.050	0	0.050	0.111	0.833	0	0.192	0	0.062	0
242	0	0.125	0.090	0	0.046	0.150	0	0	0.444	0	0	0.039	0	0	0
246	0	0	0.136	0	0.046	0.500	0	0	0.056	0	0.100	0	0.100	0	0
250	0	0	0	0.167	0	0	0	0.150	0	0	0	0.077	0.200	0.125	0
254	0	0	0	0	0	0	0	0	0	0	0	0	0.100	0	0
258	0	0	0.090	0	0.046	0	0.071	0.100	0	0	0	0	0	0	0
262	0	0	0	0	0	0	0.036	0	0	0.167	0.200	0.039	0	0	0
264/266	0	0	0	0	0.046	0	0.036	0.050	0.111	0	0	0	0	0	0.056
268/270	0	0	0.090	0	0	0	0.107	0	0.056	0.083	0	0	0.100	0.125	0
272/274	0	0	0	0	0	0	0.036	0	0	0.167	0	0.077	0	0	0.056
278	0	0.042	0	0	0	0	0	0	0	0	0	0	0	0	0
280	0	0	0	0	0	0	0	0	0	0	0	0	0	0	0.056
284	0	0	0	0	0	0	0	0	0	0	0.100	0	0	0	0
288	0	0	0	0	0	0	0.107	0	0	0	0	0	0	0	0
292	0	0	0	0	0	0	0.036	0	0	0.083	0	0	0	0	0
A	7	9	10	8	10	6	14	9	8	8	6	11	7	7	10
$F_{IS}(C\&W)$	0.248	0.287	-0.01	-0.09	0.171	0.731	0.246	-0.04	-0.12	-0.07	0.111	0.060	0.158	0.293	0.267
Hexp.	0.840	0.774	0.860	0.847	0.831	0.680	0.906	0.825	0.753	0.861	0.800	0.864	0.840	0.812	0.846
Hn.b.	0.877	0.808	0.900	0.924	0.870	0.716	0.939	0.868	0.797	0.929	0.889	0.898	0.933	0.867	0.895

Hobs.	0.667	0.583	0.090	1	0.727	0.200	0.714	0.900	0.889	1	0.800	0.842	0.800	0.625	0.667
SsaD190															
115	0.083	0	0	0	0.273	0	0.036	0.050	0.167	0	0	0.077	0.200	0	0.056
117	0	0.042	0	0	0	0	0.071	0	0	0	0	0	0	0	0
119	0.333	0.417	0.818	0.250	0.046	0	0.250	0	0.667	0.667	0.900	0.077	0.200	0.375	0.778
121	0	0	0	0	0	0.300	0	0	0	0	0	0	0	0	0
123	0.333	0.167	0.136	0.333	0.046	0	0	0.150	0	0	0	0.577	0.100	0	0
125	0	0	0	0	0	0.100	0	0	0	0	0	0	0	0	0
127	0	0	0	0	0	0	0	0	0	0	0	0.038	0.300	0.188	0.111
129	0	0	0	0	0	0.050	0	0	0	0	0	0	0	0	0
131	0	0	0	0	0	0	0.321	0.500	0	0	0	0	0	0	0
133	0	0	0	0	0	0.050	0	0.050	0	0	0	0	0	0	0
135	0	0	0	0	0	0	0	0	0	0	0.100	0	0	0.062	0
137	0	0	0	0	0	0.050	0	0	0	0	0	0	0	0	0
139	0	0	0.046	0	0	0	0.036	0	0	0	0	0	0	0.062	0
141	0	0	0	0	0.091	0	0	0	0	0.083	0	0	0	0	0
143	0	0	0	0	0	0	0.250	0.100	0	0	0	0	0	0	0
145	0.208	0.167	0	0.250	0.273	0.200	0.036	0.100	0.111	0.083	0	0.154	0.200	0	0.056
147	0	0.083	0	0	0	0	0	0	0	0	0	0	0	0	0
149	0.041	0	0	0.083	0	0	0	0	0	0.167	0	0	0	0.188	0
151	0	0	0	0	0.046	0.150	0	0	0.056	0	0	0	0	0.063	0
153	0	0.042	0	0.083	0.046	0	0	0.050	0	0.083	0	0	0	0	0
155	0	0	0	0	0.182	0.100	0	0	0	0	0	0	0	0	0
159	0	0	0	0	0	0	0	0	0	0	0	0.077	0	0	0
189	0	0.042	0	0	0	0	0	0	0	0	0	0	0	0	0
193	0	0	0	0	0	0	0	0	0	0	0	0	0	0.062	0
203	0	0.042	0	0	0	0	0	0	0	0	0	0	0	0	0
A	5	8	3	5	8	8	7	7	4	5	2	6	5	7	4
F_{IS} (C&W)	0.010	0.162	0.452	-0.25	-0.09	0.077	0.100	-0.09	-0.25	-0.21	0	-0.07	-0.18	-0.23	-0.12
Hexp.	0.725	0.757	0.310	0.750	0.802	0.820	0.763	0.700	0.512	0.513	0.180	0.634	0.780	0.773	0.377
Hn.b.	0.757	0.790	0.325	0.819	0.840	0.863	0.791	0.737	0.542	0.561	0.200	0.649	0.867	0.825	0.399
Hobs.	0.750	0.667	0.182	1	0.909	0.800	0.714	0.800	0.667	0.667	0.200	0.692	1	1	0.444

SsaD71															
183	0	0	0	0.167	0	0	0	0.150	0	0	0	0	0	0	0
185/187	0	0.042	0.046	0.167	0	0	0.036	0.400	0.056	0	0	0.038	0	0	0.056
189/191	0.083	0.125	0	0.167	0.182	0.200	0.250	0.300	0.111	0.083	0	0.077	0	0	0
193	0.125	0	0.227	0	0.318	0.100	0	0.050	0	0.083	0.300	0	0.800	0.375	0.111
197	0.125	0	0.136	0.167	0.091	0.050	0	0	0	0.367	0.100	0.154	0	0.625	0.111
201	0.042	0.167	0	0.083	0.046	0.050	0.107	0	0	0.417	0.100	0.154	0.100	0	0
205/207	0.250	0.167	0	0.083	0.046	0.100	0.142	0	0.056	0.083	0	0.231	0	0	0
209	0.083	0.292	0	0	0.091	0.250	0	0.050	0	0	0	0.269	0.100	0	0
213/215	0.042	0.083	0.318	0	0	0.100	0.179	0	0.056	0	0	0	0	0	0
217/219	0.250	0	0	0.083	0.046	0	0.214	0	0.222	0	0	0.038	0	0	0
221	0	0.125	0.273	0	0.182	0.100	0	0.050	0	0	0	0	0	0	0
225/227	0	0	0	0.083	0	0.050	0.036	0	0	0	0	0	0	0	0.167
229	0	0	0	0	0	0	0	0	0	0.167	0.500	0.038	0	0	0.444
233	0	0	0	0	0	0	0	0	0	0	0	0	0	0	0.056
237	0	0	0	0	0	0	0	0	0.111	0	0	0	0	0	0.056
241	0	0	0	0	0	0	0	0	0.111	0	0	0	0	0	0
249	0	0	0	0	0	0	0	0	0.278	0	0	0	0	0	0
262	0	0	0	0	0	0	0.036	0	0	0	0	0	0	0	0
A	8	7	5	8	8	9	8	6	8	6	4	8	3	2	7
$F_{IS}(C\&W)$	0.235	0.228	-0.04	-0.07	0.368	0.111	0.169	-0.06	0.118	0.200	0.172	0.287	-0.07	0	0.009
Hexp.	0.826	0.819	0.752	0.861	0.810	0.850	0.824	0.720	0.827	0.750	0.640	0.817	0.340	0.469	0.740
Hn.b.	0.862	0.855	0.788	0.940	0.849	0.876	0.854	0.758	0.876	0.818	0.711	0.842	0.378	0.500	0.784
Hobs.	0.667	0.667	0.818	1	0.546	0.800	0.714	0.800	0.778	0.667	0.600	0.615	0.400	0.500	0.778
Ssa85															
103	0.125	0	0	0	0	0	0.036	0.250	0	0	0	0.154	0.200	0	0
105	0.042	0.182	0.182	0.250	0	0	0.036	0	0	0.167	0	0.115	0	0.250	0
107	0.250	0	0	0.167	0.045	0	0	0	0	0.667	0.100	0	0	0	0
109	0.083	0	0	0.167	0.227	0.050	0.036	0.050	0	0	0	0	0.100	0	0
111	0.042	0.273	0.273	0.333	0.364	0.750	0.857	0.700	1	0.167	0.900	0.538	0.600	0.625	0.889
113	0.083	0.546	0.546	0.083	0.364	0.100	0	0	0	0	0	0.154	0.100	0.125	0

117	0	0	0	0	0	0.100	0.036	0	0	0	0	0.038	0	0	0.111
A	6	3	3	5	4	4	5	3	1	3	2	5	4	3	2
F_{TS} (C&W)	0.245	0.421	0.281	0	-0.02	0.325	-0.06	-0.07	-----	0.091	0	0.324	0.407	-0.11	1
Hexp.	0.736	0.406	0.596	0.764	0.682	0.415	0.260	0.445	0	0.500	0.180	0.648	0.580	0.531	0.198
Hn.b.	0.764	0.424	0.623	0.833	0.714	0.437	0.270	0.468	0	0.546	0.200	0.674	0.644	0.567	0.209
Hobs.	0.583	0.250	0.454	0.833	0.727	0.300	0.286	0.500	0	0.500	0.200	0.462	0.400	0.625	0
SSsp2216															
135	0	0	0	0	0	0	0	0	0	0	0	0	0	0	0.111
137	0	0	0.318	0	0	0	0.036	0	0	0	0	0	0	0	0.167
141	0.167	0.125	0.182	0.167	0.318	0.250	0.107	0.250	0.333	0.667	0.400	0.885	0	0.250	0.222
145	0.167	0	0	0.333	0.273	0.100	0.179	0.050	0.056	0	0.100	0	0.300	0.062	0
149	0.042	0	0	0.083	0.227	0	0	0.300	0	0	0.100	0	0	0.188	0.056
153	0	0	0	0.083	0	0.550	0.357	0.300	0	0	0	0	0	0	0.111
157	0.042	0.083	0	0.083	0.136	0	0.071	0	0	0	0	0	0	0	0
161	0	0	0	0	0.046	0	0	0	0.056	0	0	0	0.100	0	0
165	0	0	0	0	0	0	0	0.050	0	0	0.200	0	0	0	0.056
169	0	0	0	0	0	0	0	0.050	0	0	0	0	0	0	0
173	0.042	0.042	0	0	0	0.550	0	0	0.333	0.167	0	0	0	0	0.056
177	0.250	0.333	0	0.167	0	0	0	0	0.222	0	0.200	0	0	0	0
181	0.083	0.083	0	0	0	0	0.071	0	0	0.083	0	0	0.100	0	0
185	0	0	0	0	0	0	0.071	0	0	0	0	0	0	0	0.111
189	0	0	0.091	0	0	0	0	0	0	0	0	0.077	0	0.188	0
193	0	0.167	0	0	0	0.050	0	0	0	0	0	0	0.400	0.062	0
197	0.125	0.083	0.318	0.083	0	0	0.036	0	0	0	0	0.038	0	0	0.111
201	0.042	0.083	0.091	0	0	0	0	0	0	0	0	0	0.100	0.062	0
205	0	0	0	0	0	0	0.036	0	0	0	0	0	0	0	0
213	0.042	0	0	0	0	0	0.036	0	0	0.083	0	0	0	0	0
231	0	0	0	0	0	0	0	0	0	0	0	0	0	0.188	0
A	10	8	5	7	7	5	10	6	5	4	5	3	5	7	9
F_{TS} (C&W)	0.257	0.225	0.195	0.057	-0.16	0.085	0.413	-0.29	0.579	0.429	-0.25	-0.06	-0.29	0.300	0.158
Hexp.	0.851	0.816	0.748	0.806	0.752	0.620	0.809	0.750	0.722	0.514	0.740	0.210	0.720	0.820	0.864

Hn.b.	0.888	0.851	0.784	0.879	0.788	0.653	0.839	0.790	0.653	0.561	0.822	0.218	0.800	0.875	0.915
Hobs.	0.667	0.667	0.636	0.833	0.909	0.600	0.500	1	0.333	0.333	1	0.231	1	0.625	0.778
SsoSL438															
95	0	0	0	0	0	0	0	0	0	0	0	0.077	0	0	0
99	0.042	0	0	0	0	0	0	0	0	0.083	0	0	0	0	0
101	0.208	0.083	0	0.167	0	0	0.072	0.050	0	0.417	0	0.345	0	0	0.056
103	0.167	0.208	0.227	0.417	0.409	0.150	0.179	0.550	0.111	0	0.100	0.387	0.100	0.250	0.111
105	0.042	0	0.046	0	0.091	0.100	0.072	0.100	0.056	0.167	0.100	0.115	0	0.250	0.056
107	0.208	0.250	0.591	0.083	0.046	0.150	0.464	0.050	0.056	0.167	0.800	0	0.900	0.375	0.611
109	0.125	0.042	0.046	0.250	0.364	0.550	0.107	0.250	0.167	0.167	0	0.038	0	0	0.167
111	0.042	0	0.091	0	0.046	0.050	0.036	0	0.056	0	0	0.038	0	0.062	0
113	0.125	0.042	0	0	0	0	0	0	0	0	0	0	0	0	0
115	0.042	0.375	0	0.083	0.046	0	0.071	0	0.556	0	0	0	0	0.062	0
A	9	6	5	5	6	5	7	5	5	5	3	6	2	5	5
F_{IS} (C&W)	-0.04	0.365	0.118	0.600	-0.28	0.115	-0.15	0.244	0.020	0.184	-0.07	0.489	0	-0.01	-0.09
Hexp.	0.847	0.743	0.587	0.722	0.686	0.640	0.724	0.620	0.642	0.736	0.340	0.710	0.180	0.727	0.587
Hn.b.	0.884	0.775	0.615	0.788	0.719	0.674	0.751	0.653	0.680	0.803	0.378	0.738	0.200	0.775	0.614
Hobs.	0.917	0.500	0.546	0.333	0.910	0.600	0.857	0.500	0.667	0.667	0.400	0.385	0.200	0.875	0.667
OMM1064															
155	0.042	0	0	0	0	0	0	0	0	0	0	0	0	0	0
171	0	0	0	0	0.046	0	0	0	0	0.083	0	0.077	0	0	0
173/175	0.125	0.125	0	0.083	0	0.050	0.036	0	0.111	0.083	0.200	0.154	0	0	0.167
177/179	0.042	0	0	0.083	0.091	0	0	0.100	0	0	0.200	0	0	0	0
181/183	0	0.042	0	0	0	0	0	0.050	0	0.083	0.200	0.038	0.100	0	0
185/187	0	0	0	0.083	0	0	0	0	0	0.083	0	0.038	0.100	0	0.278
189/191	0.167	0	0.136	0	0	0.050	0	0.150	0.056	0	0	0.231	0.200	0.250	0
193/195	0	0	0	0	0	0	0.071	0.100	0	0	0	0.154	0.100	0.625	0
199	0	0	0	0.333	0.136	0.050	0.107	0.050	0.222	0	0	0	0	0	0
203	0	0	0	0.083	0	0.200	0.143	0	0	0	0	0	0	0	0
205/207	0.042	0.542	0	0	0	0.050	0.036	0.500	0	0	0	0	0	0	0.056
209/211	0.042	0.042	0	0	0	0	0.036	0	0	0	0.200	0.038	0	0	0.111

215	0.042	0	0	0	0	0	0.071	0	0	0.250	0	0.115	0	0.062	0.167
217/219	0	0	0	0.083	0.046	0	0.036	0.050	0	0	0	0	0	0	0
221	0.042	0	0	0	0	0	0	0	0	0	0	0	0	0	0
225	0	0	0	0	0	0.050	0	0	0	0	0	0	0	0	0
229/231	0	0	0	0.083	0.091	0.050	0	0	0	0	0	0	0	0	0
233/235	0	0	0	0	0.136	0	0.036	0	0	0.083	0	0.077	0.100	0	0.056
237/239	0.083	0	0	0	0	0.100	0.071	0	0.111	0	0.100	0	0	0	0.111
241/243	0.125	0.042	0	0.083	0.046	0	0.107	0	0.056	0.083	0.100	0	0.100	0	0.056
245/247	0.250	0.167	0.500	0.083	0.046	0.100	0	0	0.222	0.250	0	0	0	0	0
249/251	0	0	0.273	0	0.091	0	0.036	0	0	0	0	0	0	0	0
253	0	0.042	0	0	0	0	0.036	0	0.111	0	0	0	0	0.062	0
257	0	0	0	0	0.091	0.150	0.107	0	0	0	0	0	0	0	0
261	0	0	0.091	0	0	0.150	0	0	0	0	0	0	0	0	0
265	0	0	0	0	0	0	0.036	0	0	0	0	0.077	0	0	0
273	0	0	0	0	0	0	0	0	0	0	0	0	0.100	0	0
277	0	0	0	0	0	0	0	0	0	0	0	0	0.200	0	0
289	0	0	0	0	0.046	0	0.036	0	0	0	0	0	0	0	0
293	0	0	0	0	0.046	0	0	0	0	0	0	0	0	0	0
297	0	0	0	0	0.091	0	0	0	0	0	0	0	0	0	0
335	0	0	0	0	0	0	0	0	0.111	0	0	0	0	0	0
A	11	7	4	9	13	11	16	7	8	8	6	10	8	4	8
<i>F_{IS}</i> (C&W)	0.172	0.524	0.610	0.091	-0.05	0.143	0.103	0.333	0.394	0.286	0.800	0.149	0.179	0.582	0.256
Hexp.	0.861	0.656	0.649	0.833	0.909	0.880	0.918	0.700	0.846	0.833	0.820	0.864	0.860	0.539	0.833
Hn.b.	0.899	0.685	0.680	0.909	0.952	0.926	0.952	0.737	0.895	0.909	0.911	0.898	0.956	0.575	0.882
Hobs.	0.750	0.333	0.273	0.833	1	0.800	0.857	0.500	0.556	0.667	0.002	0.769	0.800	0.250	0.667